

**COGNEX**

---

# DataMan<sup>®</sup> Setup Tool

Reference Manual

08/02/2018

Revision: 6.1.3.12

# Legal Notices

The software described in this document is furnished under license, and may be used or copied only in accordance with the terms of such license and with the inclusion of the copyright notice shown on this page. Neither the software, this document, nor any copies thereof may be provided to, or otherwise made available to, anyone other than the licensee. Title to, and ownership of, this software remains with Cognex Corporation or its licensor. Cognex Corporation assumes no responsibility for the use or reliability of its software on equipment that is not supplied by Cognex Corporation. Cognex Corporation makes no warranties, either express or implied, regarding the described software, its merchantability, non-infringement or its fitness for any particular purpose.

The information in this document is subject to change without notice and should not be construed as a commitment by Cognex Corporation. Cognex Corporation is not responsible for any errors that may be present in either this document or the associated software.

Companies, names, and data used in examples herein are fictitious unless otherwise noted. No part of this document may be reproduced or transmitted in any form or by any means, electronic or mechanical, for any purpose, nor transferred to any other media or language without the written permission of Cognex Corporation.

Copyright © 2018. Cognex Corporation. All Rights Reserved.

Portions of the hardware and software provided by Cognex may be covered by one or more U.S. and foreign patents, as well as pending U.S. and foreign patents listed on the Cognex web site at: <http://www.cognex.com/patents>.

---

The following are registered trademarks of Cognex Corporation:

Cognex, 2DMAX, Advantage, AlignPlus, Assemblyplus, Check it with Checker, Checker, Cognex Vision for Industry, Cognex VSOC, CVL, DataMan, DisplayInspect, DVT, EasyBuilder, Hotbars, IDMax, In-Sight, Laser Killer, MVS-8000, OmniView, PatFind, PatFlex, PatInspect, PatMax, PatQuick, SensorView, SmartView, SmartAdvisor, SmartLearn, UltraLight, Vision Solutions, VisionPro, VisionView

The following are trademarks of Cognex Corporation:

The Cognex logo, 1DMax, 3D-Locate, 3DMax, BGAll, CheckPoint, Cognex VSoC, CVC-1000, FFD, iLearn, In-Sight (design insignia with cross-hairs), In-Sight 2000, InspectEdge, Inspection Designer, MVS, NotchMax, OCRMax, PatMax RedLine, ProofRead, SmartSync, ProfilePlus, SmartDisplay, SmartSystem, SMD4, VisiFlex, Xpand

Other product and company trademarks identified herein are the trademarks of their respective owners.

# Table of Contents

<b>Legal Notices</b> .....	<b>2</b>
<b>Table of Contents</b> .....	<b>3</b>
<b>Symbols</b> .....	<b>5</b>
<b>Getting Started</b> .....	<b>6</b>
About the DataMan Setup Tool .....	6
Overview .....	6
<b>Installation and Layout</b> .....	<b>9</b>
Installing the DataMan Setup Tool and Connecting the Reader .....	9
Tabs .....	9
Layout .....	11
Layout Customization .....	11
<b>Using the DataMan Setup Tool</b> .....	<b>13</b>
Connect .....	13
Process Monitor .....	15
Compare Configuration .....	19
Real Time Monitoring .....	20
Application Steps Overview .....	22
Optimize Image - Quick Setup .....	23
Code Details .....	27
Application Details .....	28
Format Data .....	31
Inputs / Outputs .....	34
Communications .....	35
Save Settings .....	37
Settings .....	38
Test Mode .....	38
Read Setups .....	39
Data Validation .....	40
Code Quality .....	41
Buffering and Transfer .....	42
Actions and System .....	44
View .....	44
Image Viewer .....	45
Results Viewer .....	47
<b>Backstage Pages</b> .....	<b>49</b>
Maintenance .....	49
Virtual Devices .....	50
Backup .....	51
Restore .....	52
Update Firmware .....	53
Device Grouping .....	54
Reader Groups .....	54
Custom Grouping .....	54
Managing Master-Slave Groups .....	56

Image Playback ..... 58

**Options ..... 60**

**Help ..... 62**

**Troubleshooting ..... 64**

Image Acquisition ..... 64

Communication ..... 64

# Symbols

The following symbols indicate safety precautions and supplemental information.

---

 **WARNING:** This symbol indicates the presence of a hazard that could result in death, serious personal injury or electrical shock.

---

 **CAUTION:** This symbol indicates the presence of a hazard that could result in property damage.

---

 **Note:** Notes provide supplemental information about a subject.

---

 **Tip:** Tips provide helpful suggestions and shortcuts that may not otherwise be apparent.

---

# Getting Started

## About the DataMan Setup Tool



Using the DataMan Setup Tool, you can access a wide range of options involving DataMan readers, including reviewing images of the barcodes being read live, or setting up the reader to transfer no read images via FTP for later review.

This powerful software simplifies initial reader setup and changing parameters of the readers you use. The DataMan Setup Tool is a common platform across all models. It simplifies deployment by putting the most common controls in a single page, allowing you to see how different options affect the reader in real time.

## Overview

To be able to connect to your reader or base station on your computer, you must perform the following steps:

1. [Install](#) the DataMan Setup Tool on your computer.
2. Select the appropriate connection type and connect the appropriate cabling.
3. Power on your device(s).

The user interface is built up of the following main components:

**Backstage:** Upon starting the **DataMan Setup Tool**, the so-called backstage opens. It provides a means to start certain operations like starting to work on the devices (connecting to them, monitoring them, monitoring the data of the selected device or devices), or process monitoring, RTM, comparing configurations, or listing currently available user-defined custom groups for editing.

This page is also accessible via the **Home** () button.

*Example:*

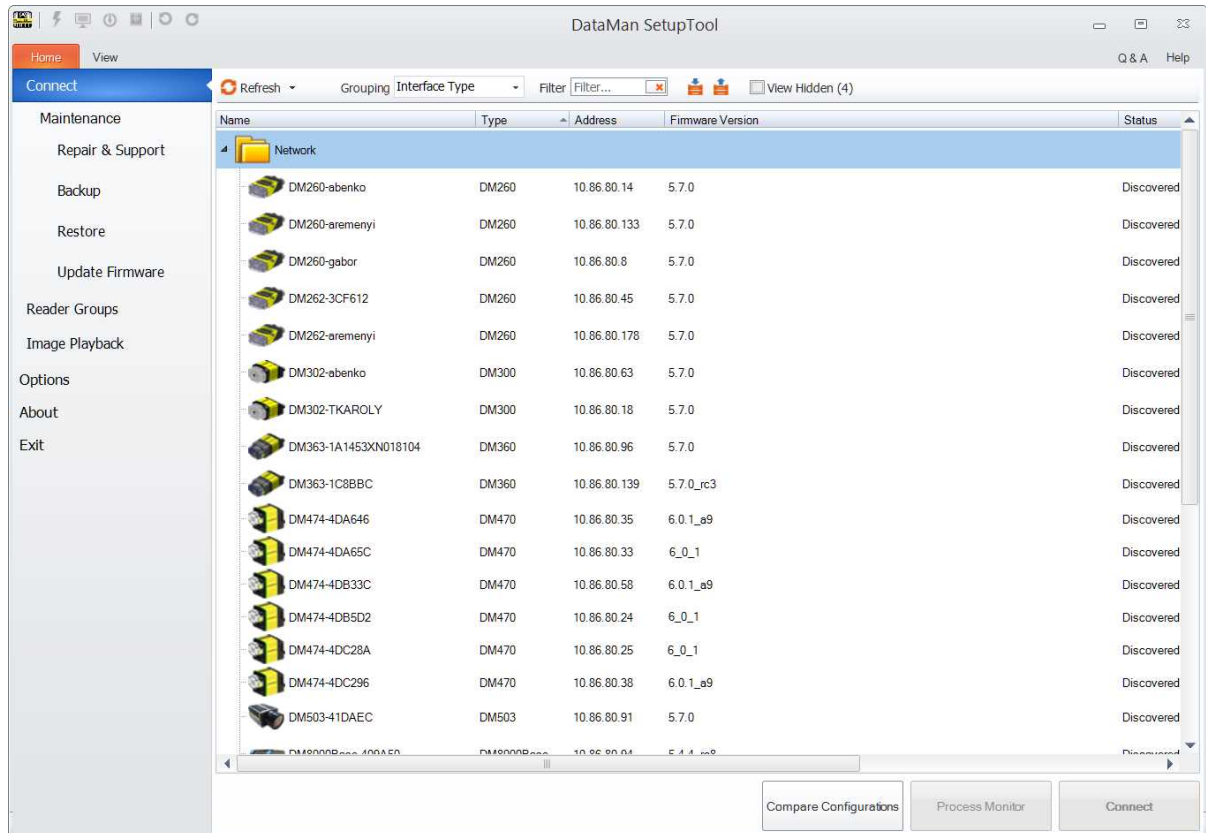

You can navigate between the different backstage pages by selecting the horizontal tab headers on the left:

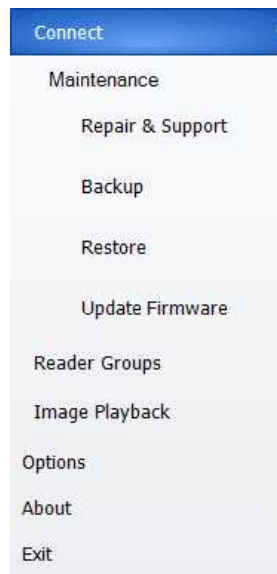

**Document:** A new *document* opens when the desired operation on the backstage is selected (e.g. you selected a device to connect to and clicked Connect). The backstage control is automatically hidden, the newly opened document appears and gets the focus. If more than one documents are open (e.g. there are more device connections), each document gets its own tab. Switch between the different documents by clicking on their respective tab.

*Example:*

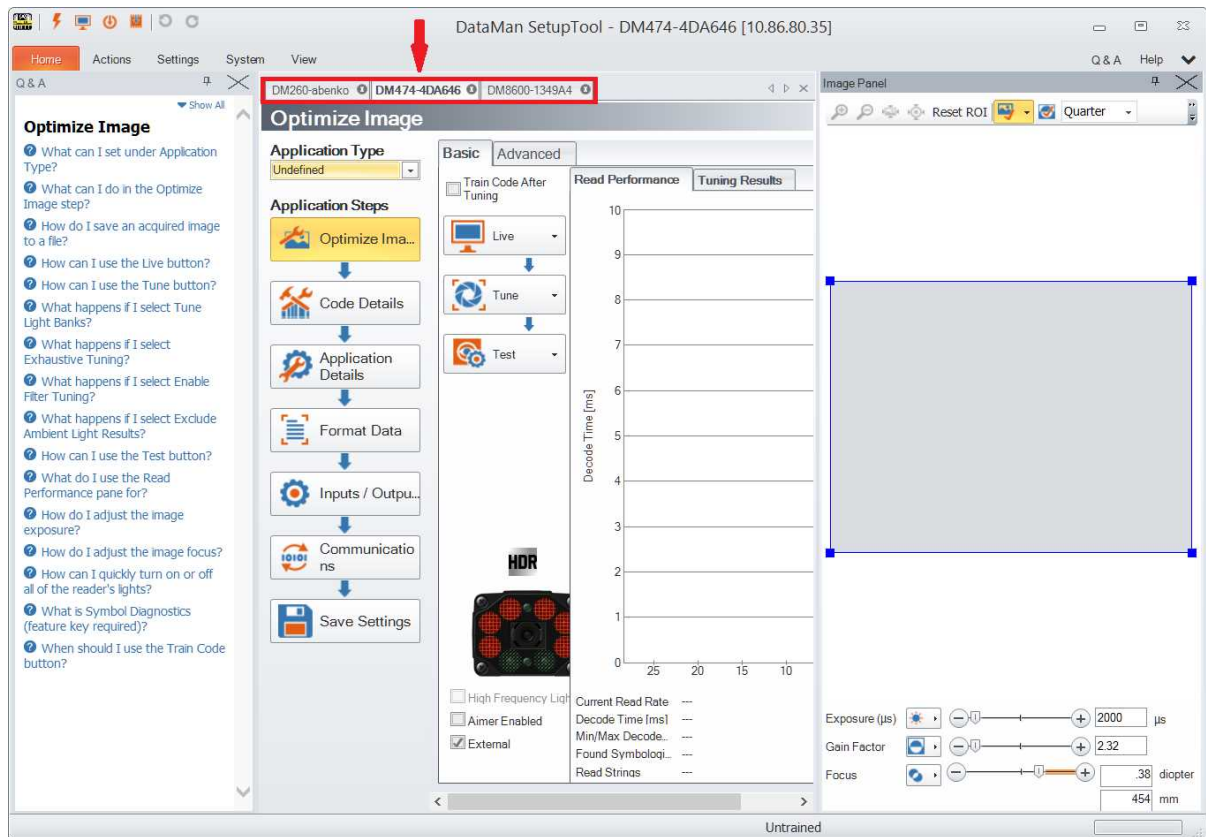

The **Image Panel** pane is always displayed by default, on the right hand side.

The currently active document's title is shown in **bold** if it has the focus. You can switch between different documents by clicking on the related tab. Documents can be closed by clicking the  in the upper left corner of the tab.

**Ribbon bar:** The upper part of the window provides place for the context sensitive ribbon bar, the items (buttons, checkboxes, etc.) differ for each document type. The ribbon bar shows controls for the currently active document.

*Example:*

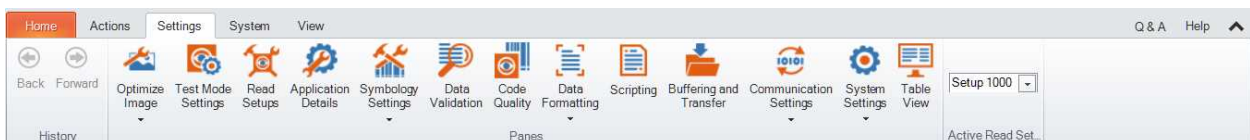

The ribbon bar is context-sensitive, which means that its items (buttons, checkboxes, etc.) is different for each document type and they show controls for the currently active (selected) document.

The following sections provide more details about the installation of the software and the components of the GUI.



# Installation and Layout

In this section, you will learn how to install the DataMan Setup Tool, how it looks like and how the layout can be customized.

## Installing the DataMan Setup Tool and Connecting the Reader

Perform the following steps to install the DataMan software on the PC you will use to configure the settings for each DataMan reader:

1. Check the DataMan **Release Notes** for a full list of system requirements.
2. Download the **DataMan Setup Tool** from <http://www.cognex.com/support/dataman> and follow the on-screen steps.  
If the installation utility does not start automatically, double-click on the **setup.exe** file in the installation folder.
3. Connect your DataMan reader to your PC.
4. Choose **Start->Cognex->DataMan Software vX.X.X->Setup Tool** to launch Setup Tool (where **vX.X.X** stands for the relevant revision of the software).
5. In the **Connect** menu, click **Refresh** to have Setup Tool auto-detect the DataMan readers connected to communication ports on your PC.  
Any DataMan reader available over your network will appear in the **Connect** menu.
6. Select a COM port listing or Network device listing corresponding to your DataMan reader and click **Connect**.

For the most up-to-date information, consult the English-language documentation. The translated documents supplied with some releases may not include recent updates.

## Tabs

The tabs of the DataMan Setup Tool are context sensitive. Upon first opening the DataMan Setup Tool, you will see two tabs: **Home** and **View**.

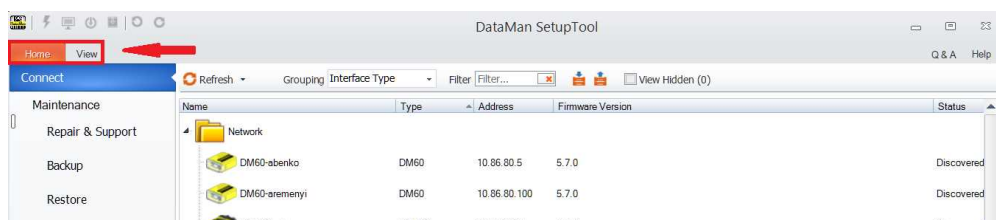

After selecting a device and connecting to it, more tabs will be available.

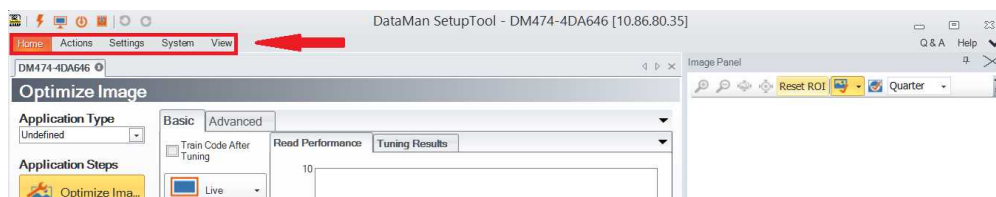

And the tabs also change based on the document you are currently using. For example, when using the [Process Monitor](#), you will have these tabs:



The tabs and their functions will be described later in this document with their respective views.

## Layout

The DataMan Setup Tool makes it possible for users to organize the layout to fit the computer screen or to make the desired components larger and make the less used ones smaller.

## Layout Customization

As discussed in the previous section, the layout of the DataMan SetupTool is customizable. The components of the application are:

- organizable to tabs
- pinnable to remain visible
- unpinable to auto-hide on mouse leave
- dockable to different areas of the main window
- undockable from the application to a separate window

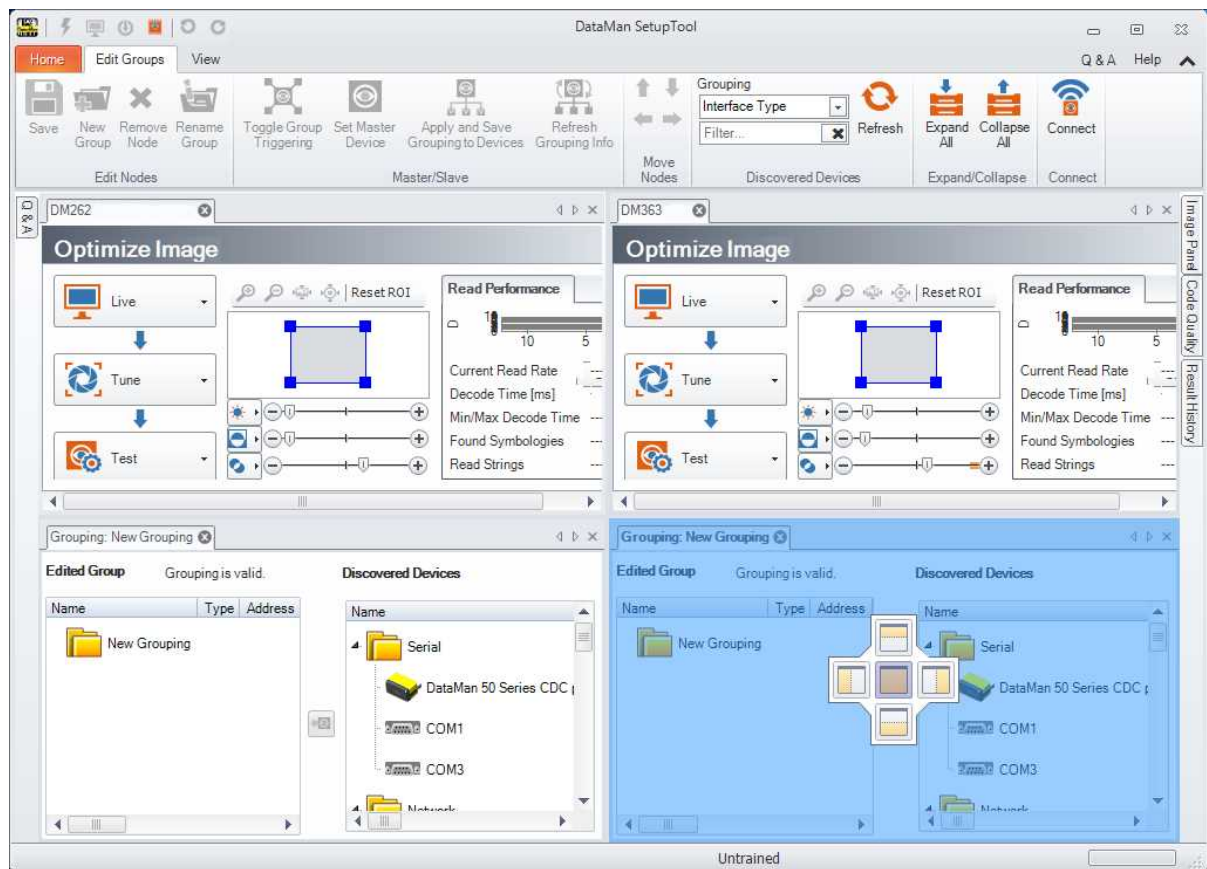

You can drag and drop the grabbed documents wherever you wish, but the ribbon bar under View also offers buttons for tiling the windows horizontally or vertically:

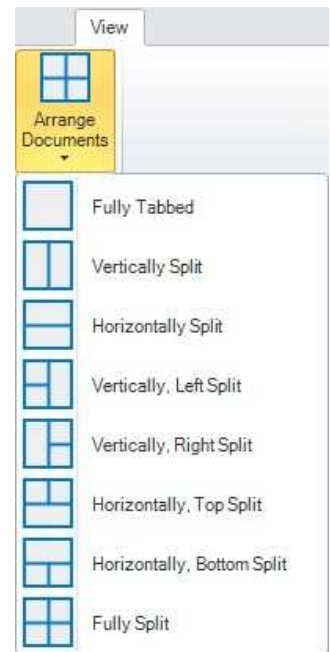

# Using the DataMan Setup Tool

This section describes how to connect to a device through the DataMan Setup Tool, and it contains information on the most essential functions that you can use when setting up your reader and reading codes.

## Connect

The **Connect** page provides the ability to connect to a single device or several devices at the same time. The devices are shown in a tree structure. The tree structure shows additional information for each device in separate columns.

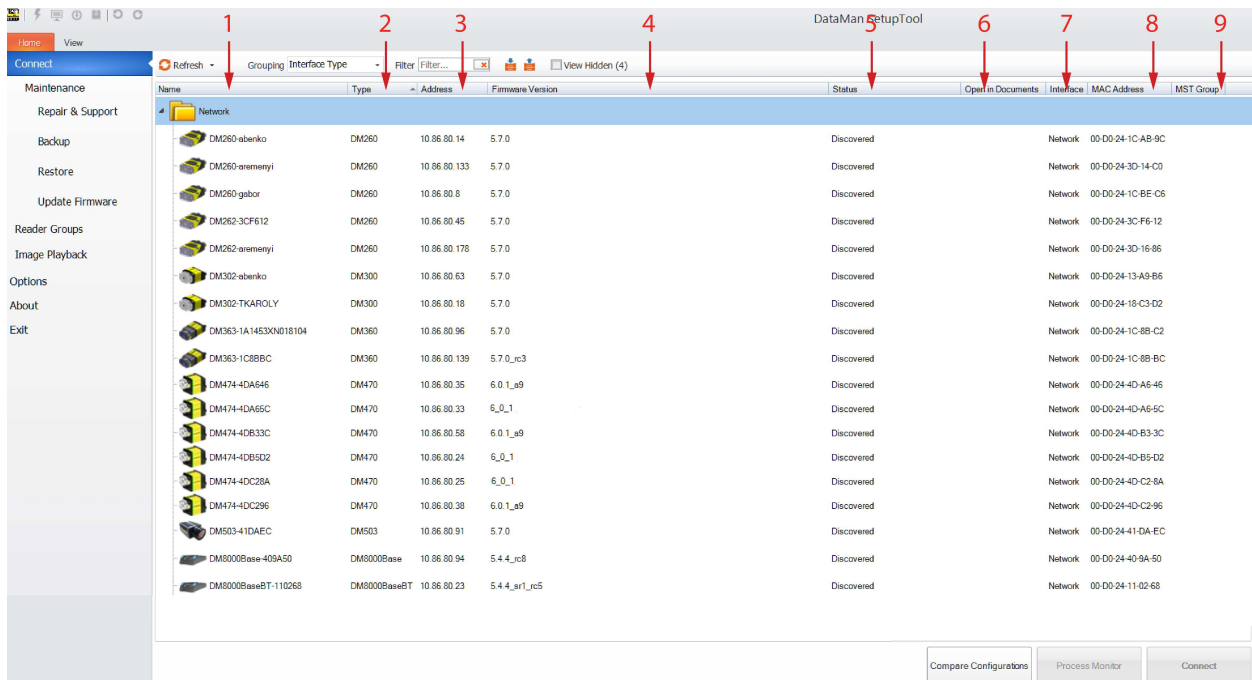

The additional pieces of information shown are the following:



1. Device name and icon
2. Device type
3. Device address (IP address or port)
4. Firmware version
5. Status (e.g. Discovered, Misconfigured, Conflicting, In use)
6. The reader is open in the linked document
7. Interface (e.g. Serial, Network, HID)
8. The NIC (MAC address) via which the device was discovered
9. The Master Group the device belongs to in case of master-slave grouping

Click **Refresh** to refresh the list of available devices and their settings.

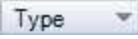





The tree and grid-like device list control provides the following options:

- **Sorting:** Each column in the grid can be sorted, both in an ascending and a descending alphabetical order, by clicking on the column header. The sorting direction is shown by a triangle. For example:  or . The triangle is shown only in the sorted column. By default, the **Type** column is sorted in an ascending order.
- **Grouping:** You can use different groupings when showing the discovered devices. You can choose from built-in groupings, but you can also define your custom groupings. The built-in groupings are the following:



They are based on the same data as the data in the related column of the grid. Only one grouping can be selected at a time using the designated combo box. The default grouping is *None*.

For more details on reader groupings, see the [Device Grouping](#) section.

- **Filtering:** The  text field filters the list of discovered devices based on the characters typed in. The list of devices gets updated based on filtering on each key stroke. The filtering text can be cleared by deleting the filter text or clicking on the clear () button. The filter text is matched to each column in the device list grid and only those rows remain visible that have a column which contains the text provided in the filter text.
- **Expanding/collapsing the device tree:** The displayed tree of devices can be collapsed and expanded fully, as well as on a node-by-node basis. Full collapse or expand can be done with the designated buttons (expand: , collapse: ) , whereas node-by-node collapse or expand can be done by clicking on the desired node's collapse/expand triangle (  ).
- **Viewing hidden devices:** You can view the hidden devices when the  **ViewHidden (2)** checkbox is selected.

After selecting one or more devices (click/Ctrl-click/Shift-click), a connection can be initiated by clicking the **Connect** button or double-clicking on a device. Connection gets initiated to the selected device(s) and separate documents are opened.

Upon connecting to a device, a *device document* is opened, it gets its own tab. For such a device, the **Status** column will show "In Use" on the device list pages. The connection gets closed when its document tab is closed. If the device reboots (e.g. because of a firmware update), the document tab remains open, the progress bar and messages inform you about the current state of the device. If a connection is lost, the document tab does not get automatically closed, an overlay message informs you about this event. If the reader goes offline, the overlay with the message stays there until the device comes back online or until you close the document tab.

## Process Monitor

You can use the **Process Monitor** to check the operation of one or more devices at the same time with only a minimal interruption in their work. This page can be accessed via [Connect](#).

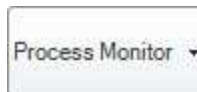
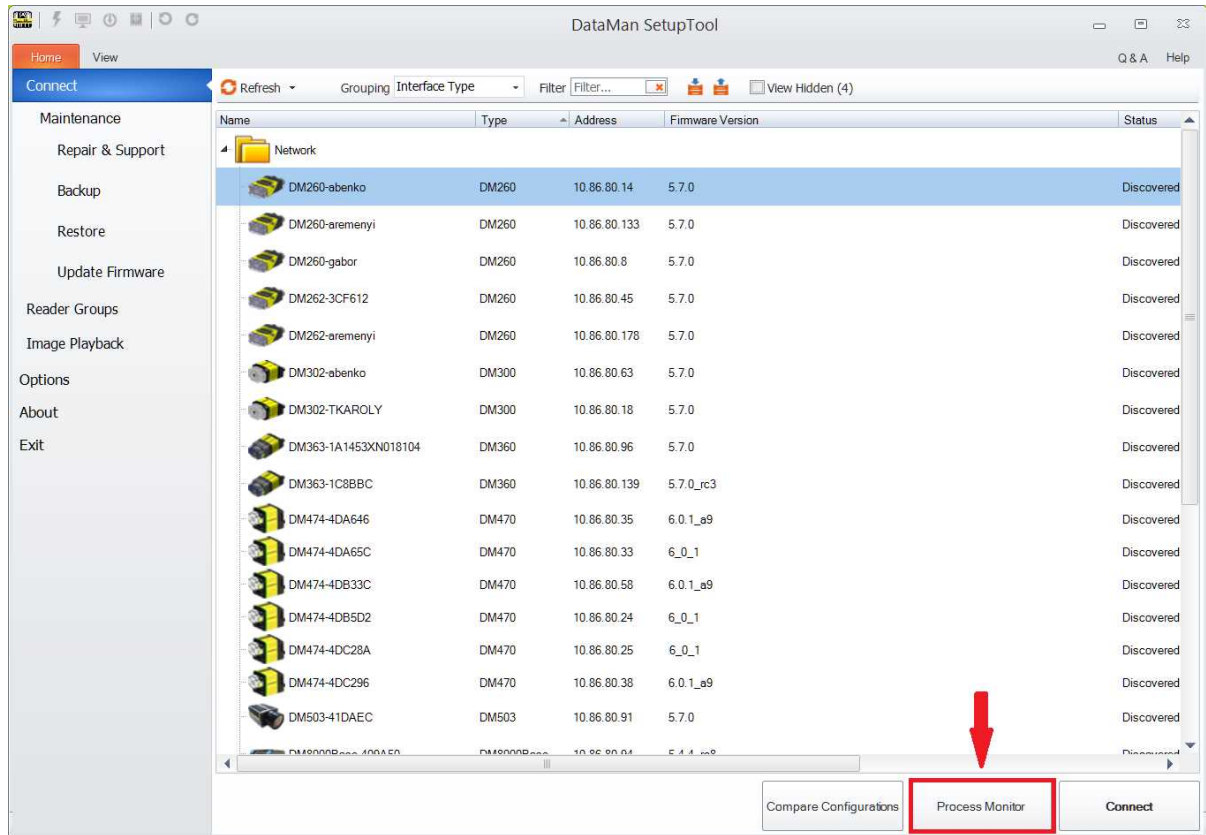

Selecting one or more devices from the list and clicking the  button opens a single **Process Monitor** document where the monitored data of the selected device or devices is shown.

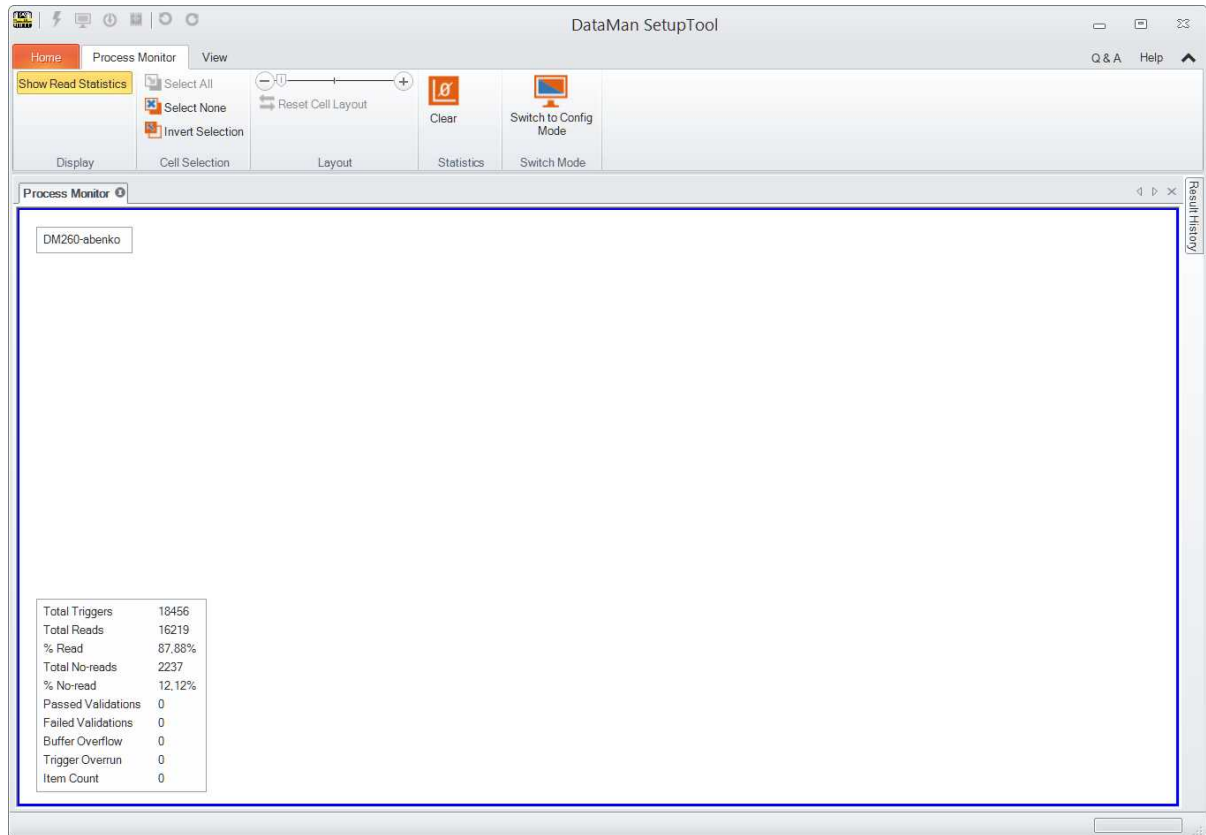

If more than one devices were selected, all will be shown in the Process Monitor, but you can add a new device to the Process Monitor by clicking on **Add to Process Monitor** on the Connect page, which is available if you click the



downward arrow in the Process Monitor button:

Read more about this option in [Multi-reader Process Monitor](#).

## Multi-reader Support

The DataMan Setup Tool allows connections to a number of readers simultaneously. You can select one or more devices to connect to on the [Connect](#) backstage page.

### Multi-reader Process Monitor

The DataMan Setup Tool can show performance statistics of multiple DataMan readers in a single **Process Monitor** view. The **Process Monitor** backstage page displays readers that support such monitoring. Select one or more devices



and click the button to open a new Process Monitor document tab that displays real time statistics of the selected readers.

More than one DataMan readers can be monitored on a single Process Monitor tab. A statistics panel opens for all monitored readers and displays read and no-read count, percentage and other statistical data for the respective readers. The panels are arranged in a tiled style.

*Example:*



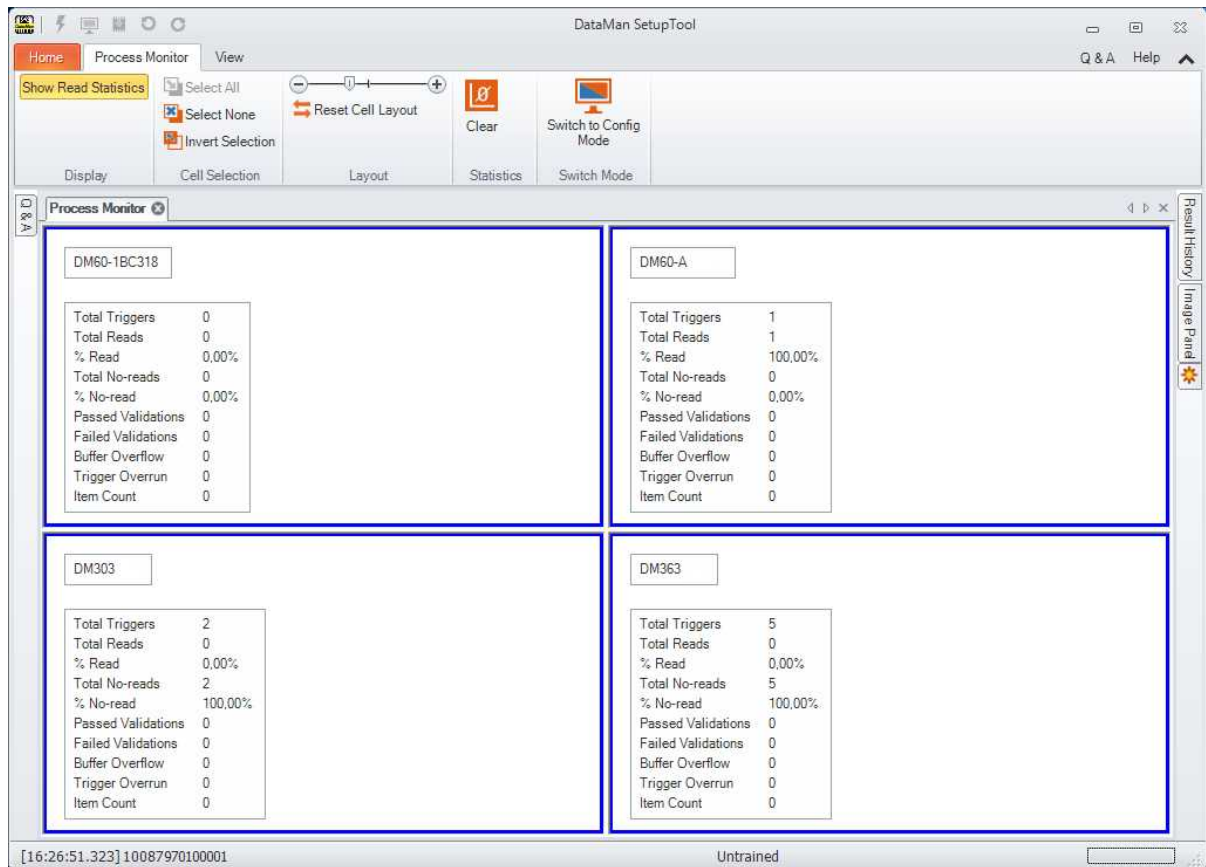

You can turn displaying read results and statistical data on and off by clicking on the respective buttons on the ribbon bar: **Show Read Results** and **Show Read Statistics**.



Clear the read statistics in the selected panels any time during run time by clicking the **Clear Statistics** (  ) button on the ribbon bar. The buttons in the **Cell Selection** ribbon group make it easy to select multiple readers before doing mass actions:



More than one Process Monitor document tabs can be created, which show statistical data for different devices or device groups.

**Note:** One device can be opened in only one Process Monitor document at a time. Devices that are already opened  in a Process Monitor document or opened for configuration are dimmed on the Process Monitor backstage page and are shown as **In Use**.

Process Monitor views can be closed by clicking on the  button on the left of the tab title. Titles of the tabs are auto-

generated but the tabs can be renamed.

Readers can be added to already open Process Monitor views. The **Process Monitor** button becomes a drop-down button if at least one Process Monitor view is started and the existing Process Monitor views are listed in the drop-down menu. You can add a reader to the existing view by clicking the **Add to** option.



If more than one Process Monitor is open, you will see the list of available Process Monitors to which you can add the newly selected device.



Readers can be removed from Process Monitor views by clicking the 'X' button on the top-right corner, which appears when hovering the mouse over the individual statistics panels.

## Compare Configuration

Compare Configuration is a table view style tool used to set, copy, compare, or restore device configurations and settings, which enables users of multiple devices to quickly synchronize configurations or check for inconsistencies. Select multiple devices from the device list and click the **Compare Configuration** button to initiate the tool in a new document that opens.

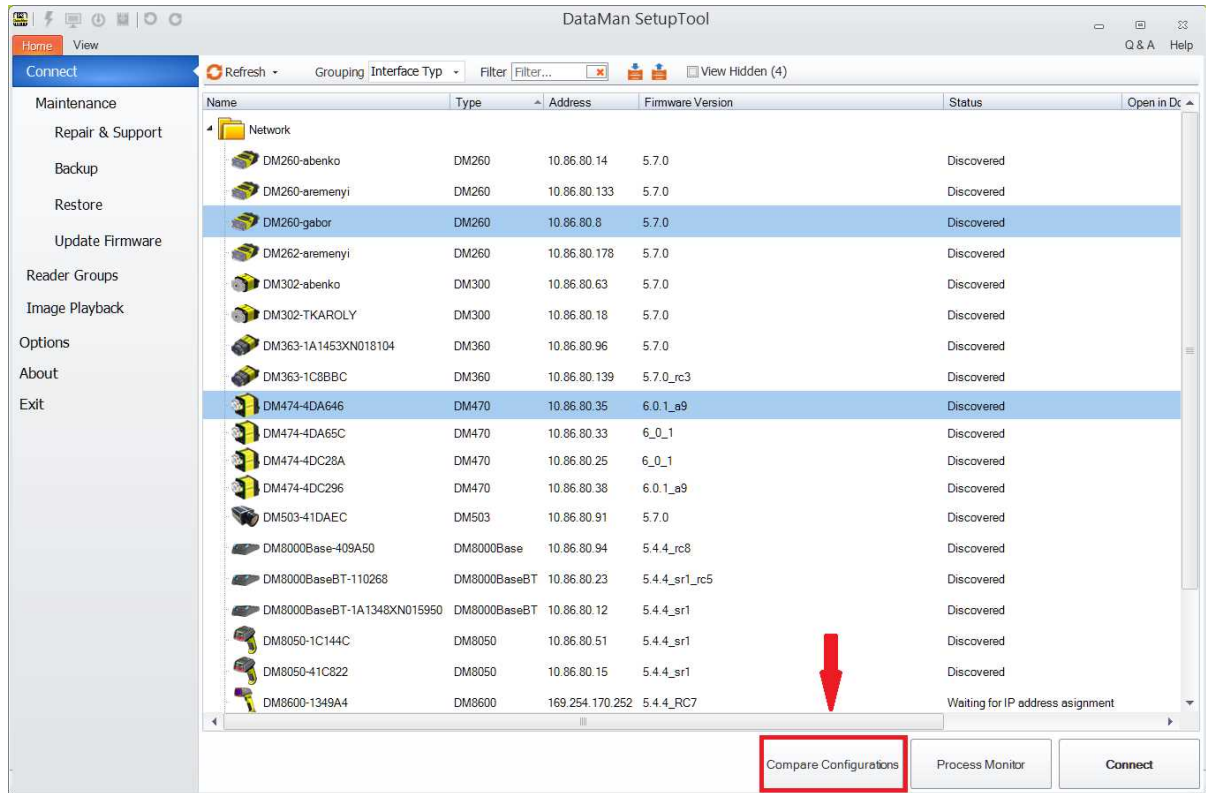

In the new document that opens, the table view lists all settings of the selected devices, while the ribbon menu on top allows you a number of actions relating to these settings.

	DM260-gabor	DM474-4DA646		
	Global Settings / Setup 0	Global Settings / Setup 0	Setup 1	Setup 2
<b>Read Setup</b>				
Name	Setup 0	Setup 10000000000000000000	Setup 0	Setup 2
Enabled	<input checked="" type="checkbox"/>	<input checked="" type="checkbox"/>	<input checked="" type="checkbox"/>	<input checked="" type="checkbox"/>
<b>System Info</b>				
Device	DM260X			
Serial number	1A1524XN007950	1A1729PP268425		
Device name	DM260-gabor	DM474-4DA646		
MAC address	00-D0-24-1C-BE-C6	00-D0-24-4D-A6-46		
Firmware version	5.7.0	6.0.1_a9		
Application Loader version	1.16.0.49			
Failsafe version	1.10.0.47			
Installed hardware	Liquid Lens	Liquid Lens		
Feature keys	IDMax, ImageDownload, IDQuic...	IDMax, ImageDownload, IDQuic...		
Bootloader version		2016.09-103-g990e348		
OS Version		DM470_v6.0.1_a9		
<b>Tuning</b>				
Train Code	<input checked="" type="checkbox"/>	<input type="checkbox"/>		
Tune Light Banks	<input checked="" type="checkbox"/>	<input checked="" type="checkbox"/>		
Force Exhaustive Tuning	<input checked="" type="checkbox"/>	<input type="checkbox"/>		
Optimize Focus	<input checked="" type="checkbox"/>	<input checked="" type="checkbox"/>		
Exclude Ambient Light Results	<input type="checkbox"/>	<input type="checkbox"/>		
<b>Test Mode Settings</b>				
Test Mode	<input type="checkbox"/>	<input type="checkbox"/>		
Automatic Triggering Enabled	<input checked="" type="checkbox"/>	<input checked="" type="checkbox"/>		
Trigger On [µs]	20 000	20 000		
Trigger Off [µs]	500 000	1 980 000		
Enable Inputs	<input type="checkbox"/>	<input type="checkbox"/>		
Enable Outputs	<input type="checkbox"/>	<input type="checkbox"/>		
Number of Triggers to be Accepted	1	1		
<b>Light and Imager Settings</b>				
<b>Trigger Settings</b>				
Trigger Type	Single (external)	Continuous (external)		
<b>Motion Detection</b>				

For more detailed information on **Compare Configuration** and its features, look for the **Q and A panel** of the page itself.

## Real Time Monitoring

Real Time Monitoring (RTM) is a feature built into DataMan Setup Tool that allows for the collection and analysis of different kinds of data related to devices on the network and their readings and displaying this data in graphs. RTM can be connected to as a regular device on the Connect page.

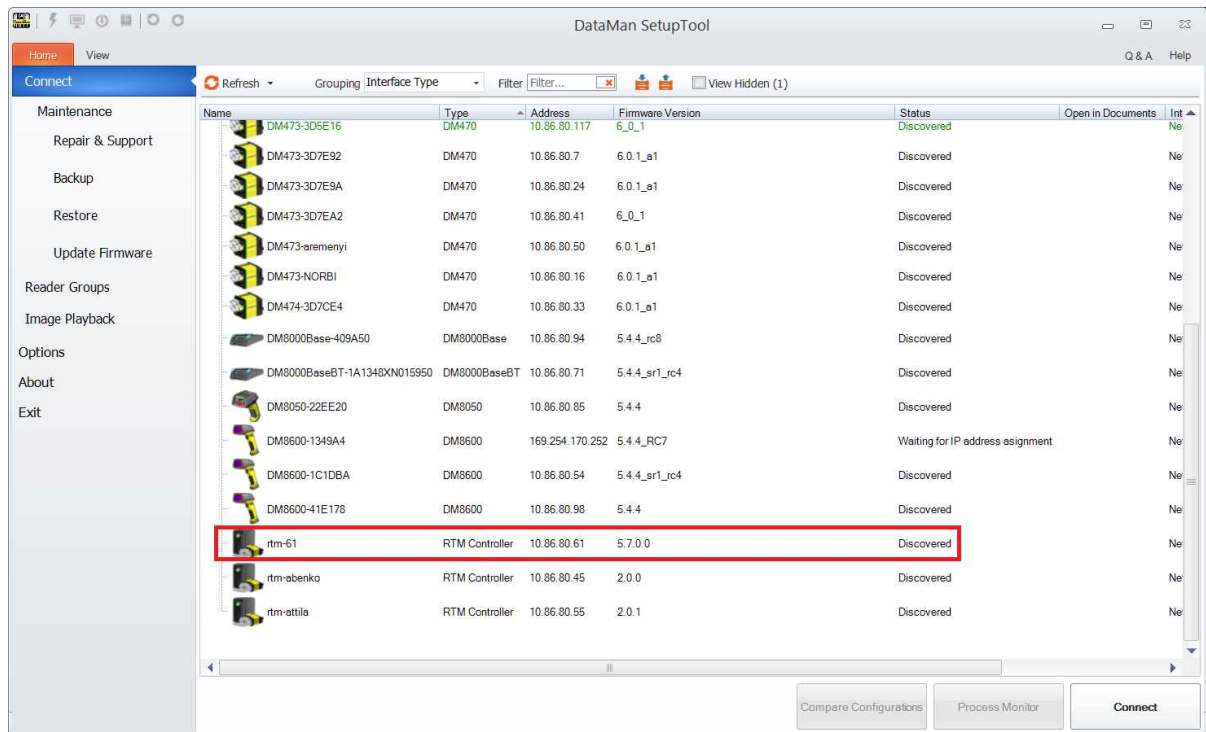

Once connected to RTM, the ribbon menu allows setup and monitoring options. The target device for data acquisition, as well as the selection of the type of data collected, can be set up under **Configuration** on the ribbon menu. By default, RTM collects statistical data (Read rate, No-read count, average decode time, trigger count, trigger overrun, buffer overflow, and process control metrics, if enabled on the device).

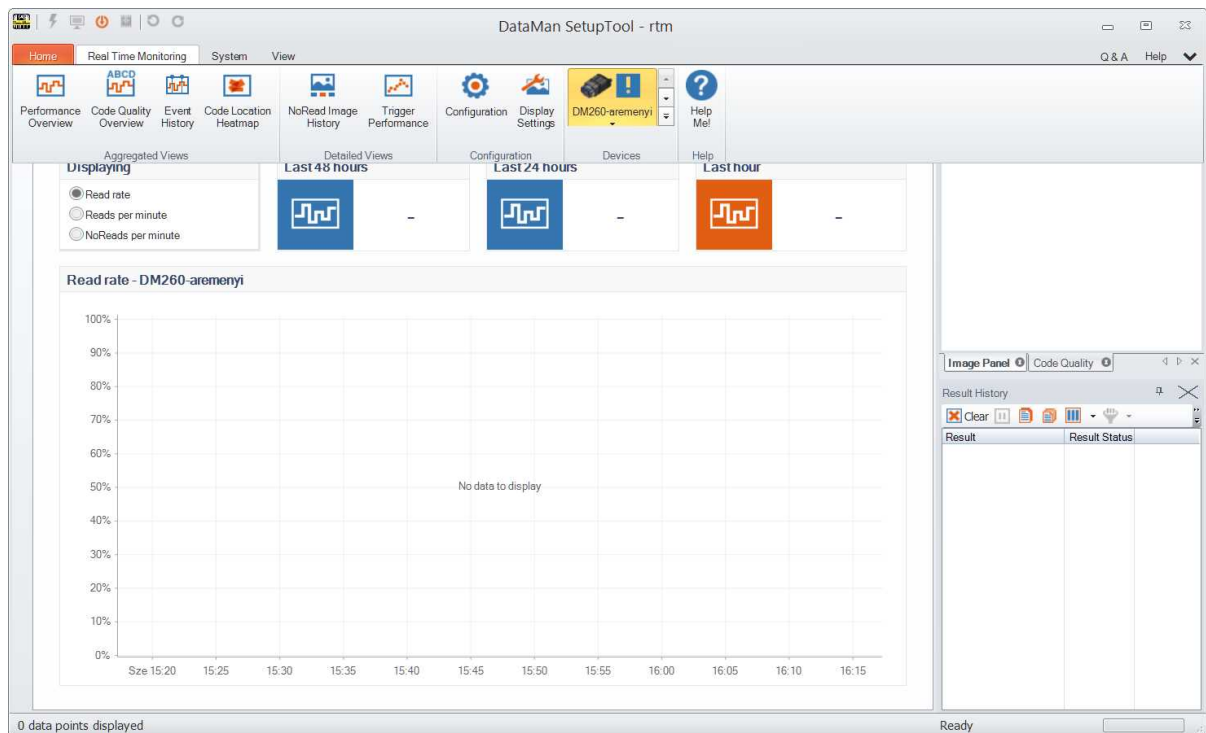

For a more detailed description of RTM capabilities and options, refer to the **Q and A** help of RTM.

## Application Steps Overview

Upon connecting to a device, the following page opens:

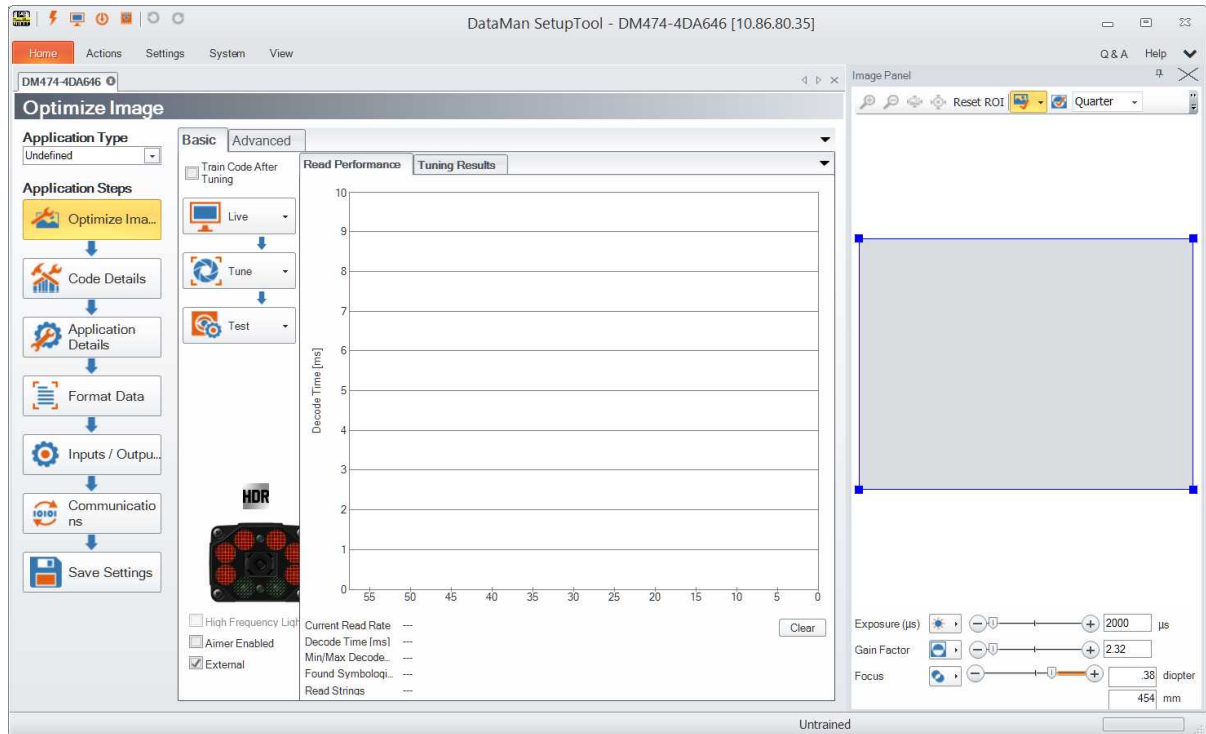

On the left hand side you can see a column displaying **Application Steps**. These steps make it easier for you to quickly configure and set up your tool. Most of the steps have basic and advanced setting options on different panes. Advanced options include all basic setting options and further extra ones.

First set the **Application Type** by selecting one of the options from the drop-down:

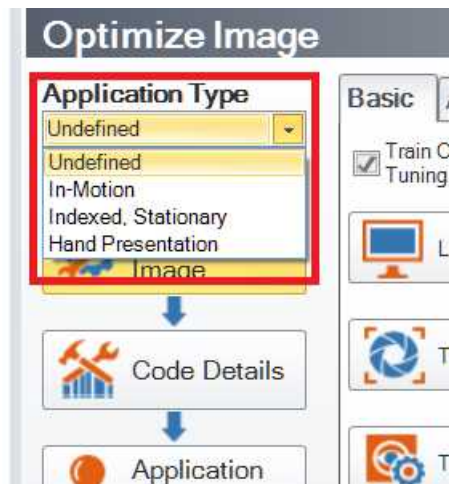

and then walk through the application steps starting with **Optimize Image**.

The application steps cover the following configuration options:

- **Code Details** is the step to set symbologies.
- **Application Details** contains all light and imager, decode and displayed image settings.

- **Format Data** provides setting options regarding data formatting including standard, perl style, and script-based.
- Under **Inputs / Outputs** you can implement system settings.
- You can have all **Communications** settings implemented, including serial and ethernet options.
- With the **Save Settings** action button you can save all your configurations in an easy way.

## Optimize Image - Quick Setup

The first application step is **Optimize Image**. This pane is the first one because it provides you a means for a quick setup in one step.

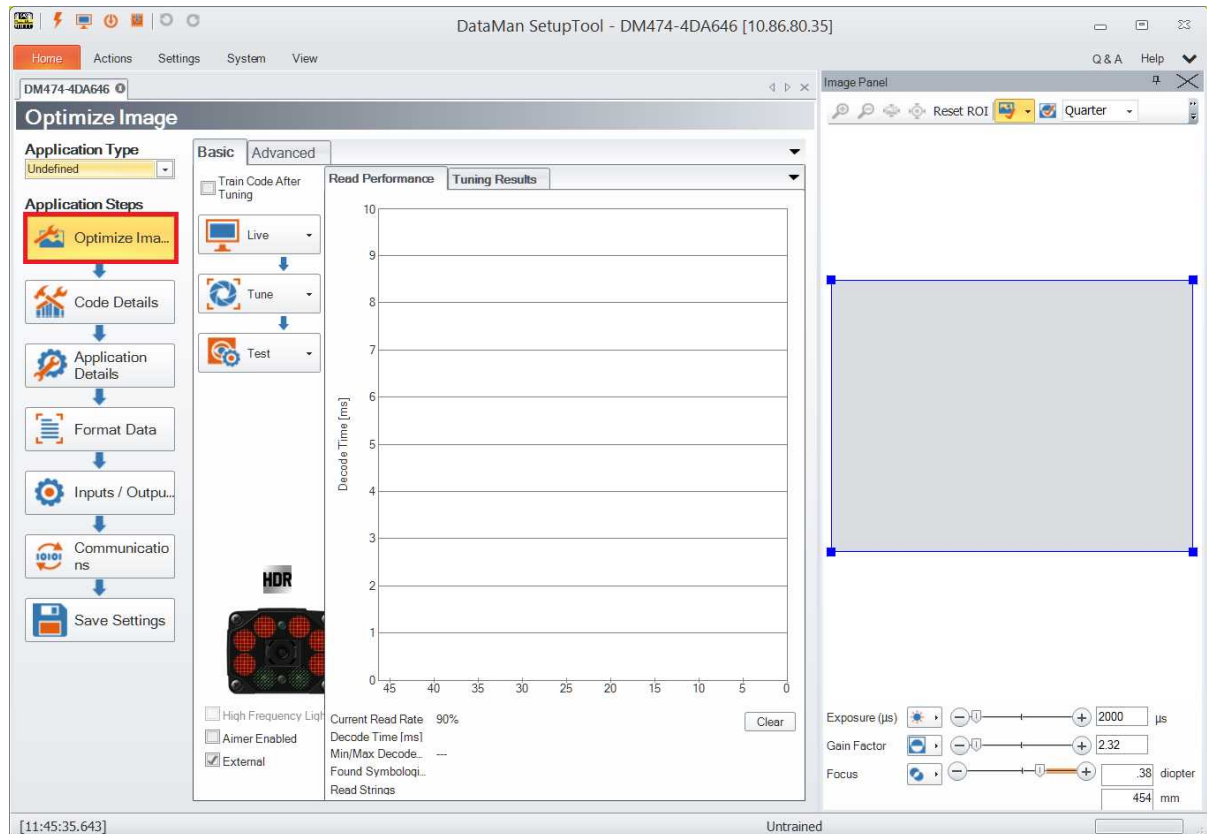

In order to quickly set up your device, it is recommended to go through the following major steps:

- Live
- Tune
- Test

These functions are represented by the three large buttons. With each button, there is a drop-down window offering additional options that opens when clicking on the right-most side of the button.

*Example:*



## Live

Click the **Live** button to enter *Live mode*. Live mode not only monitors what the device sees, but it decodes as well. In the drop-down window of the Live button (see above), you can find further options to configure Live mode and reader settings.

The following controls provide a subset of frequently used reader settings, which are duplicates of controls from other DataMan Setup Tool panes:

- Tick **Decoding** if you want the device to decode the taken images.
- When checked, **Focus Feedback** displays a color-coded meter on the right side of the image view. The meter indicates the focus of the lens (lower is less focused).
- Select the **Automatic Exposure** option to have the reader automatically determine the best exposure settings.

In the image view, you can change the region of interest (ROI) of the reader by sliding/dragging the blue ROI box. This is the area the reader will attempt to perform reads on.

## Tune

Click the **Tune** button to automatically find the best settings for your reading. The advanced window reveals the following features:

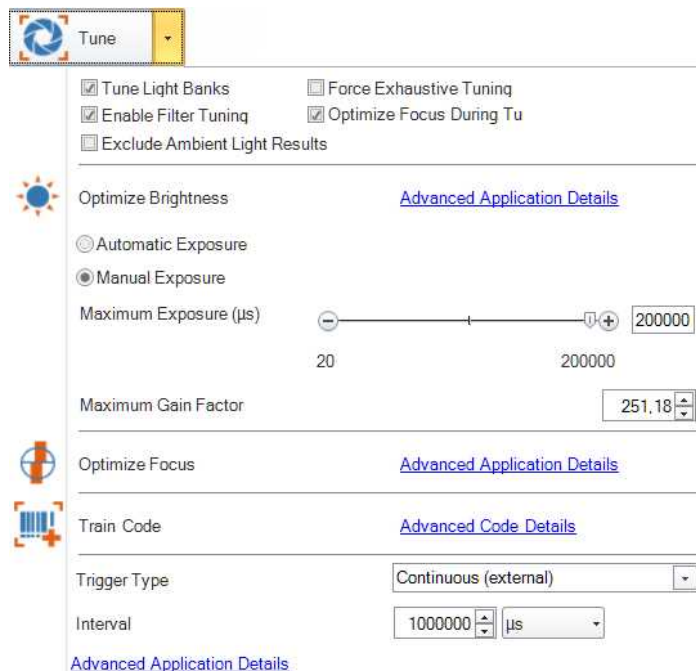

- Click **Optimize Brightness** to set the recommended brightness for your device automatically (only available if *Manual Exposure* is set), or, for advanced settings, click the link next to the button to navigate to the appropriate pane under **Application Details**. Alternatively, click the brightness icon under the image, or use the slider for manual brightness setup.



- Choose between **Automatic Exposure** or **Manual Exposure** as desired for your application. Camera gain can be controlled by a separate slider.
- Use the **Maximum Gain Factor** to set the target's maximum pixel brightness.
- Click **Optimize Focus** to set the recommended focus for your device automatically, or, for advanced settings, click the link next to the button to navigate to the **Advanced** tab under **Application Details** or the appropriate pane under **Light and Imager Settings**. Alternatively, click the focus icon under the image, or use the slider for manual focus setup.

**Note:** It only appears when using a liquid lens.

- Click **Train Code** to train codes, or click the link next to the button to navigate to advanced code training settings.
- You can configure the reader with any of the following **Trigger Types** if **Manual Exposure** is set (some trigger types are not available on all devices):
  - **Single** triggering acquires a single image and attempts to decode any symbol it might contain. This trigger mode supports a read timeout.
  - **Presentation** triggering continuously scans for a symbol and decodes it each time one is detected.
  - **Manual** triggering acquires images as long as the trigger signal remains active, and stops when a symbol is found and decoded or the trigger signal ends.
  - **Burst** triggering acquires a set number of images and decodes the first symbol it detects within the group. You can configure the number of images within each burst as well as the interval between each image acquisition. This trigger mode supports a read timeout.
  - **Self** triggering is similar to presentation triggering in that the reader continuously scans for a symbol and decodes it each time one is detected.
  - **Continuous** triggering acquires images as long as the trigger signal remains active, where the reader acquires images at a specific interval and attempts to scan any symbols each successive image contains.

The **Tuning Results** pane on the right shows a detailed tuning graph.

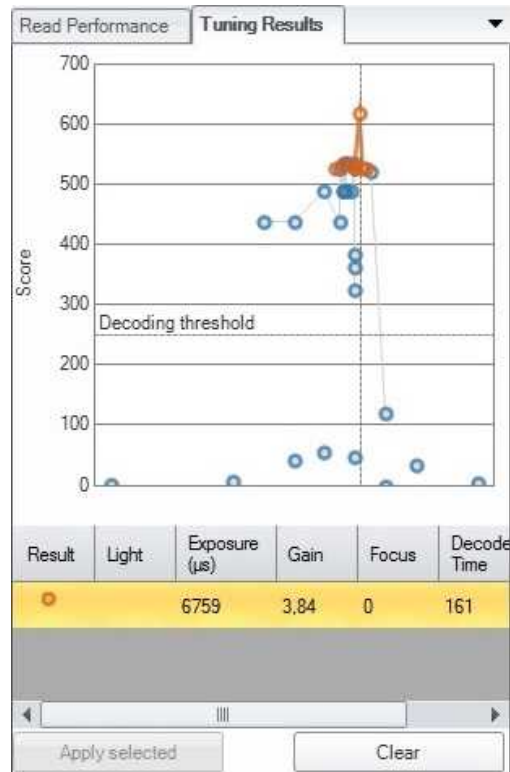

You can select a result other than the recommended one by clicking on it and then clicking **Apply selected** in the bottom row:

- If you set **Tune Light Banks**, the device tunes the light banks. If you know which light settings you want to use, disable it, so the tuning doesn't overrule your preset.
- Selecting **Exhaustive Tuning** will *force* tuning the light banks. When Exhaustive Tuning is disabled, and the reader succeeds to read the code with the primary light setting (1st one in the sequence), it will stop to try other light bank combinations. If Exhaustive Tuning is on, the reader will continue to try all combinations to look for the best one, no matter whether or not the first one succeeded.
- If **Enable Filter Tuning** is selected, the DataMan Setup Tool applies filters to the read image. The filter using which the code is successfully read is then shown in the Tuning Results pane under **Image Filter**.
- If you want the focus to be automatically optimized during tuning, check the **Optimize Focus During Tuning** option.
- Check **Exclude Ambient Light Results** if you do not want only ambient light results to be automatically selected for the tuning process (which would otherwise be the prevailing illumination type for fix mount readers).

## Test

Click the **Test** button to test your device with a configuration, without any disruption to production.

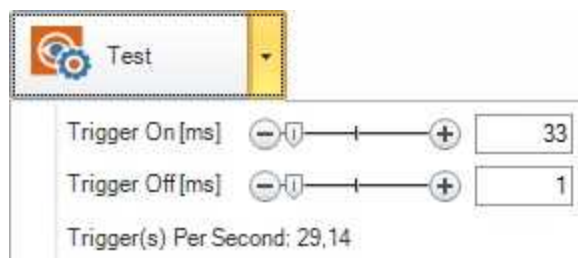

If you selected a trigger type that is external (that is, not Presentation or Self trigger mode) under the **Live** button, you can trigger the reader automatically using **Test mode** to validate and test your application. You can set up an appropriate duty cycle for the reader using the **Trigger On** and **Trigger Off** times. For your convenience, you can see the calculated trigger frequency.

You can either reduce *Trigger On* or *Trigger Off* times to reduce the cycle time, and thus increase trigger frequency.

**Note:** Depending on the read setup, code to read, and connection interface, there might be speed limitations, and at higher speeds, it can help to disable image transfer. For more information, see the QandA pane in the DataMan Setup Tool.

## Read Performance

With the graphs in the **Read Performance** pane on the right, you can monitor decode times and read rates in real time. Click the **Clear** button to reset the graph.

## Code Details

In this application step you can select the different types of symbologies to be used. On the **Basic** tab you can disable all or untrained symbologies and enable all of them. You also have the option to select 2D, 1D, Stacked and Postal symbologies separately and set the number of codes you need to read for each trigger.

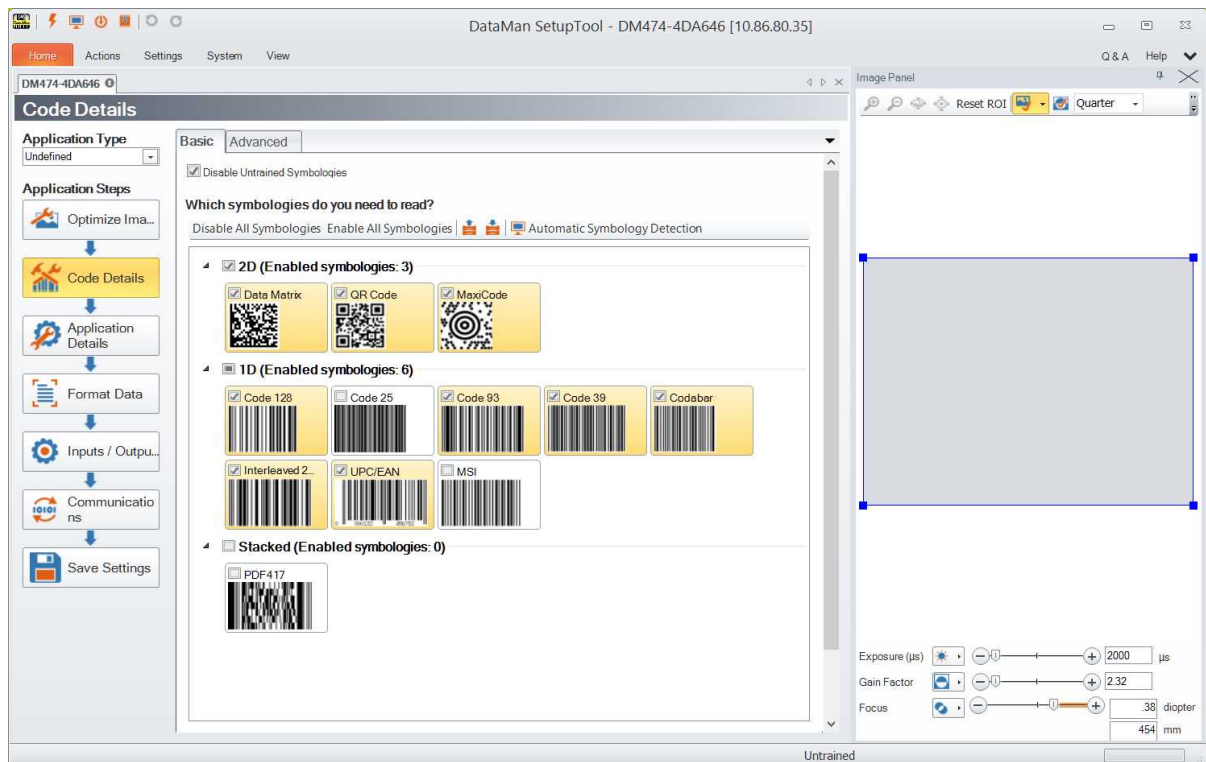

On the **Advanced** tab you can configure further data apart from the ones you can also set on the **Basic** tab.

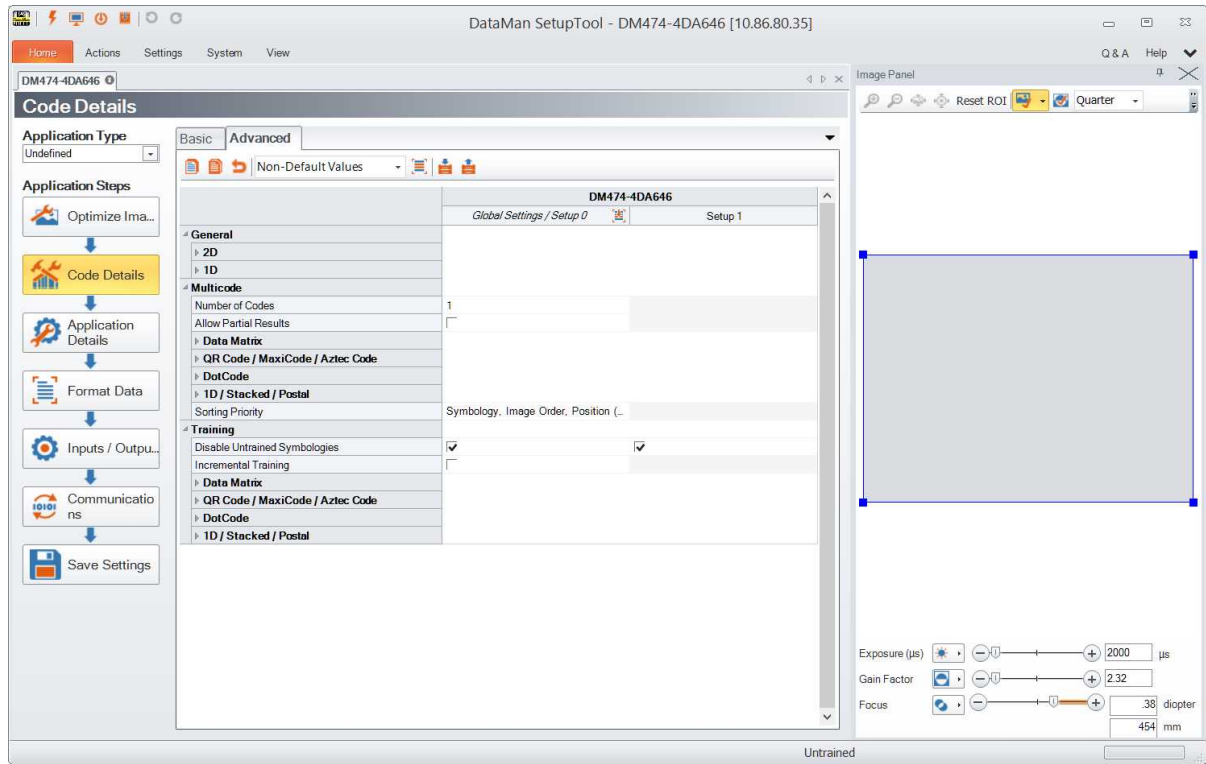

## Application Details

This step deals with the light and imager settings. The **Basic** tab gives you the opportunity to set the trigger types, its delay, timeout, interval and burst length. Exposure options and data can also be given.

The different assistants help you in configuring these settings.

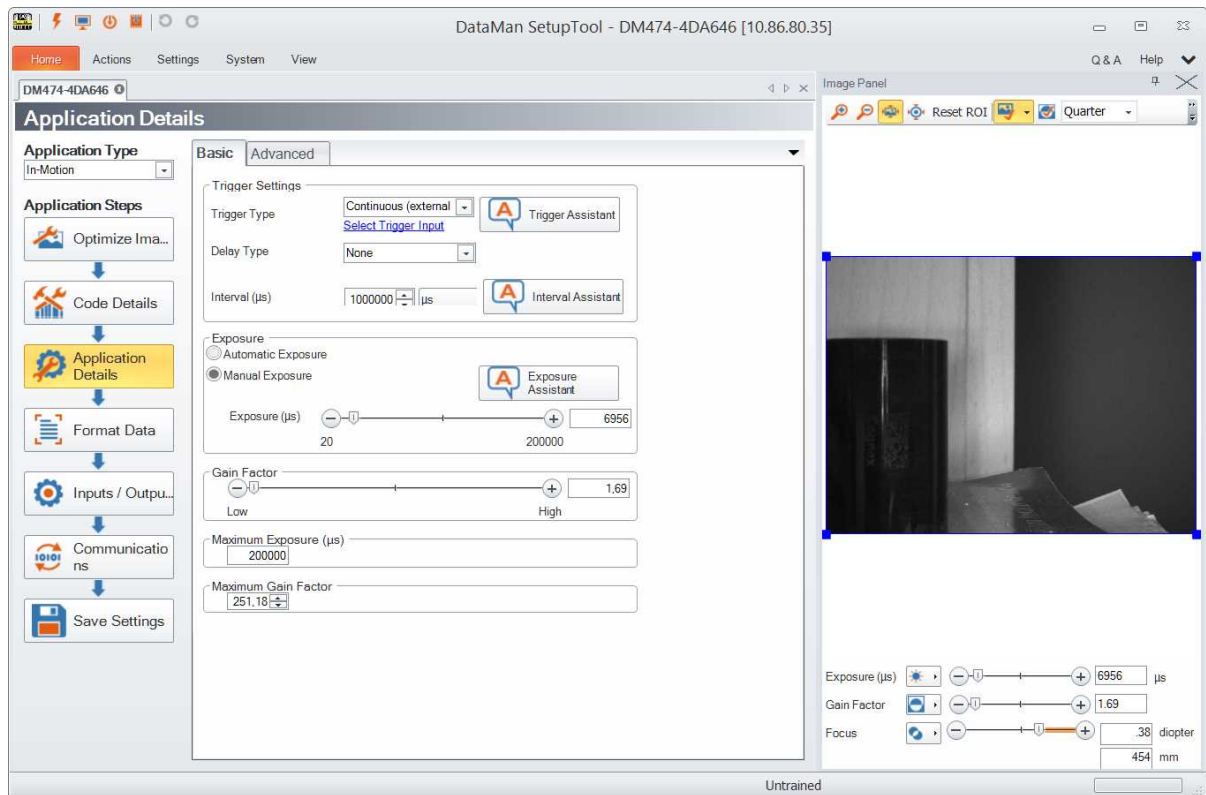

## Trigger Assistant

You need to select the trigger type first for this assistant to work. Select the trigger source from the drop-down: Undefined, None or External. You get a recommendation from the assistant for the trigger modes. Graphical presentations of the trigger types help you decide. Select the chosen trigger type and click **Save and Close**.

*Example:*

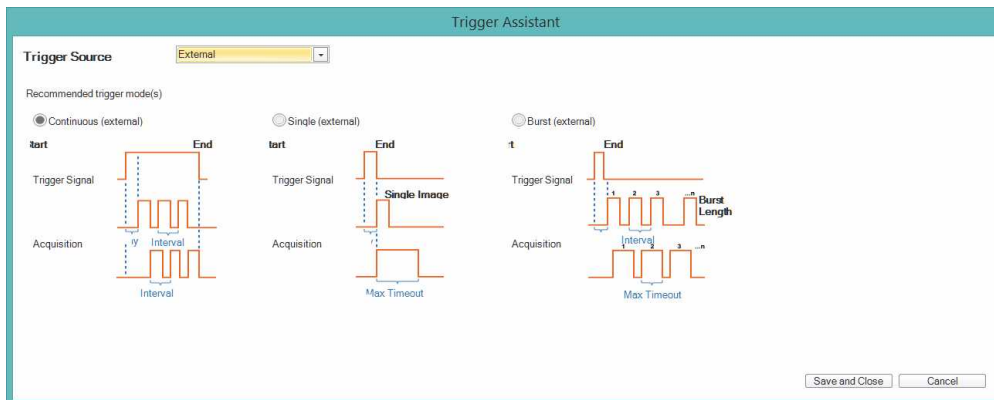

## Interval Assistant

In the case of Self and Continuous modes the Interval Assistant can help you make further settings. You can select three ways to calculate the necessary data. In the top right corner select the units (standard or metric) you wish to calculate in.

With the help of **Field of View** you can calculate the longest possible interval time by measuring the physical field of view and giving the maximum line speed and the size of the longest code.

Clicking **Lens / Distance to Code** is calculating with the distance of the code from the lens. Give the focal length from the drop-down and select the direction in which the code is travelling. Here you also need to give the maximum line speed and the size of the longest code.

**Code Element Size** calculates with the size of the most narrow code element. Enable **Test Mode** to read your code. You also need to give the direction your code is travelling in, the maximum line speed and the size of the longest code.

At the bottom of the Assistant you get the recommended maximum interval time.

*Example:*

Interval Assistant

1. Select one of the below application details to input!

Units: Metric

Field of View Size     Lens / Distance to Code     Code Element Size

2. Measure the field of view size in the direction of travel at the closest reading distance!

Live

mm

3. Enter your maximum line speed

m/s

4. Enter the length of the longest code (in the direction of travel)

mm

Recommended Maximum Interval time is: µs

Save and Close    Cancel

## Exposure Assistant

The Exposure Assistant is very similar to the Interval Assistant. You can select the same three ways for your calculations: Filed of view size, distance to code, and code element size.

Clicking **Field of View** helps you calculate the recommended maximum exposure time by measuring the physical field of view and giving the maximum line speed. You can enable **Test Mode** to read your smallest code.

Clicking **Lens / Distance to Code** is calculating with the distance of the code from the lens. Give the focal length from the drop-down and select the direction in which the code is travelling. Here you also need to give the maximum line speed.

**Code Element Size** calculates with the size of the most narrow code element. Enable **Test Mode** to read your code. You also need to give the direction your code is travelling in and the maximum line speed.

At the bottom of the Assistant you get the current and the recommended maximum exposure time.

*Example:*

Exposure Assistant

1. Select one of the below application details to input!



Field of View Size
  Lens / Distance to Code
  Code Element Size

Units:

2. Lens focal length:  mm

3. Enter distance from the closest reading point to front of light:  mm

4. Which direction is the code(s) travelling in the image?

5. Enter your maximum line speed:  m/s

6. Enable Test Mode to read your smallest code (at the closest reading distance)

Test Mode
 Code PPM is:

Current Exposure is:   $\mu$ s

Recommended Max Exposure is:   $\mu$ s

On the **Advanced** tab you can implement displayed image settings.

## Format Data

**Note:** Platforms: DataMan 50, DataMan 60, DataMan 70, DataMan 150, DataMan 260, DataMan 300, DataMan 360, DataMan 474, DataMan 503, DataMan 8050, DataMan 8600

In addition to standard formatting possibilities, you have the option to write a script inside the DataMan Setup Tool.

You can enable script-based formatting under the **Format Data** application step's **Basic** tab. Clicking **Data Formatting** in the **Settings** pane also navigates you to the **Format Data** application step:

The screenshot shows the DataMan SetupTool interface. At the top, there is a navigation bar with 'Home', 'Actions', 'Settings', 'System', and 'View'. Below this is a header for 'DM474-4DA646' and a 'Format Data' section. The 'Format Data' section has a sidebar with 'Application Type' (Undefined) and 'Application Steps' (Optimize Ima..., Code Details, Application Details, Format Data, Inputs / Outpu..., Communicatio ns, Save Settings). The 'Format Data' step is highlighted in yellow. The main content area has tabs for 'Basic', 'Standard', 'Perl Style', and 'Scripting'. Under the 'Basic' tab, there are radio buttons for 'Basic Formatting' (selected) and 'Script-Based Formatting' (highlighted with a red box). Below these are checkboxes for 'Standard' and 'Perl Style' for various barcode types: Universal, Data Matrix, 1D / Stacked / Postal, and QR Code / MaxiCode / Aztec Code. A text input field labeled 'No Read Output String' is also visible.

When script-based formatting is enabled, you can define a JavaScript module to format data according to your needs on the **Scripting** tab of the **Format Data** application step.

*Example:*



**Format Data**

Application Type: Undefined

Application Steps: Optimize Images, Code Details, Application Details, **Format Data**, Inputs / Outputs, Communications, Save Settings

Basic | Standard | Perl Style | **Scripting**

Data Formatting | **FTP Storage** | Communication

Enable [Script-Based Formatting](#) to configure settings on this pane

```
// Default script for data formatting
function onResult (decodeResults, readerProperties, output)
{
    if (decodeResults[0].decoded)
    {
        output.content = decodeResults[0].content;
    }
}
```

99 kbytes left Ln 9 Col 1

Test

To reach this document, click **Scripting** in the **Format Data** application step.

If your DataMan device, for instance, uploads its images to an FTP server, the images on the server get a certain file name. This file name can be customized with the help of the script that can be edited under the **FTP Storage** tab.

*Example:*

**Format Data**

Application Type: Undefined

Application Steps: Optimize Images, Code Details, Application Details, **Format Data**, Inputs / Outputs, Communications, Save Settings

Basic | Standard | Perl Style | Scripting

Data Formatting | **FTP Storage** | Communication

Enable [Script Generated File Name for FTP](#) to configure settings on this pane.

```
// Default script for FTP file name generation
function onGenerateFTPfilename(decodeResults, readerProperties, output)
{
    var ftp_filename = readerProperties.name + "-";
    ftp_filename += readerProperties.trigger.index + "-" + decodeResults[0].;
    return ftp_filename;
}

// Default script for FTP PCM report file name generation
function onGenerateFTPFCMReportFilename(decodeResults, readerProperties, output)
{
    var ftp_filename = readerProperties.name + "-";
    ftp_filename += readerProperties.trigger.index + "-" + decodeResults[0].;
    return ftp_filename;
}
```

On the **Communication** tab, you can edit your custom communication protocols.

*Example:*

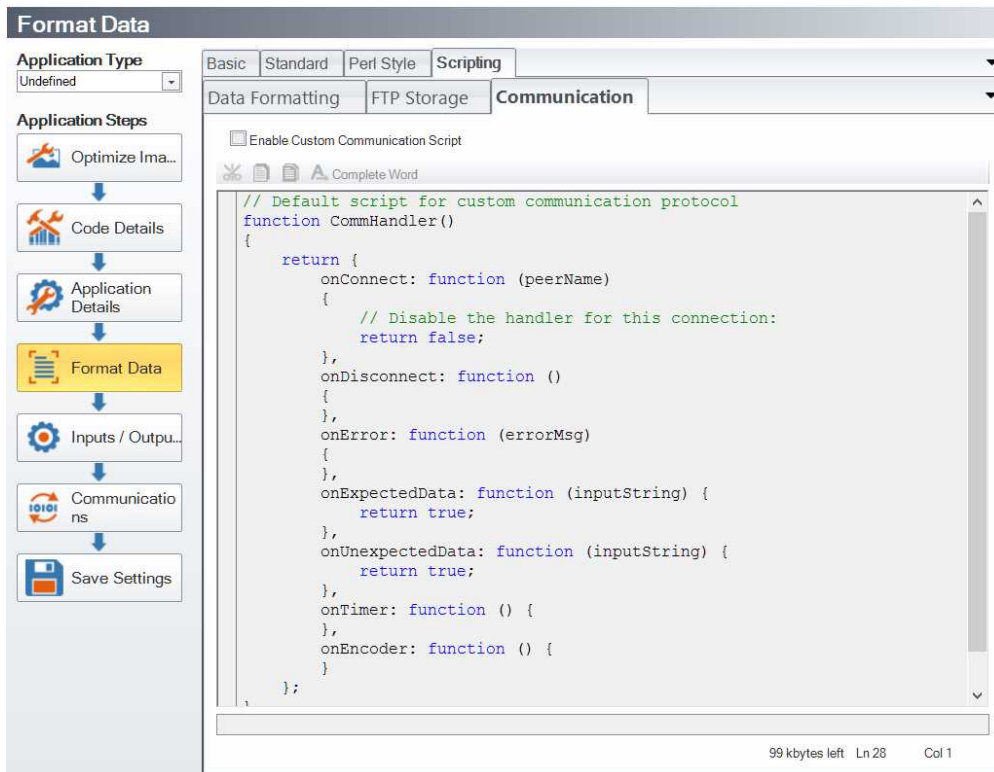

For more information on the custom communication protocols, see the ***DataMan Communications and Programming Guide***.

The script for data formatting not only allows you to have different data formatting combinations, but you can also perform operations on the output channel, for example, to *pull output 1 up*. You can *configure read results* flexibly and *configure reader events* before the result returns.

For the details of how to write the script and for scripting examples, please see the ***DataMan Communications and Programming Guide***. You can find scripting samples by clicking the arrow of the **Insert Snippet** drop-down menu or right-clicking within the text field and selecting **Insert Snippet** from the pop-up list.

You can open your own scripts through the DataMan Setup Tool's **Scripting -> Open Script...** option.

## Inputs / Outputs

This application step is the place to set all system settings regarding decode and device time settings, master/slave and wake-up message settings. You can configure the input and output data.

The **Basic** tab enables you to configure the behavior of the trigger and tune buttons, inputs, outputs and pulse encoder data. Height sensor data can also be set for devices that it is relevant.

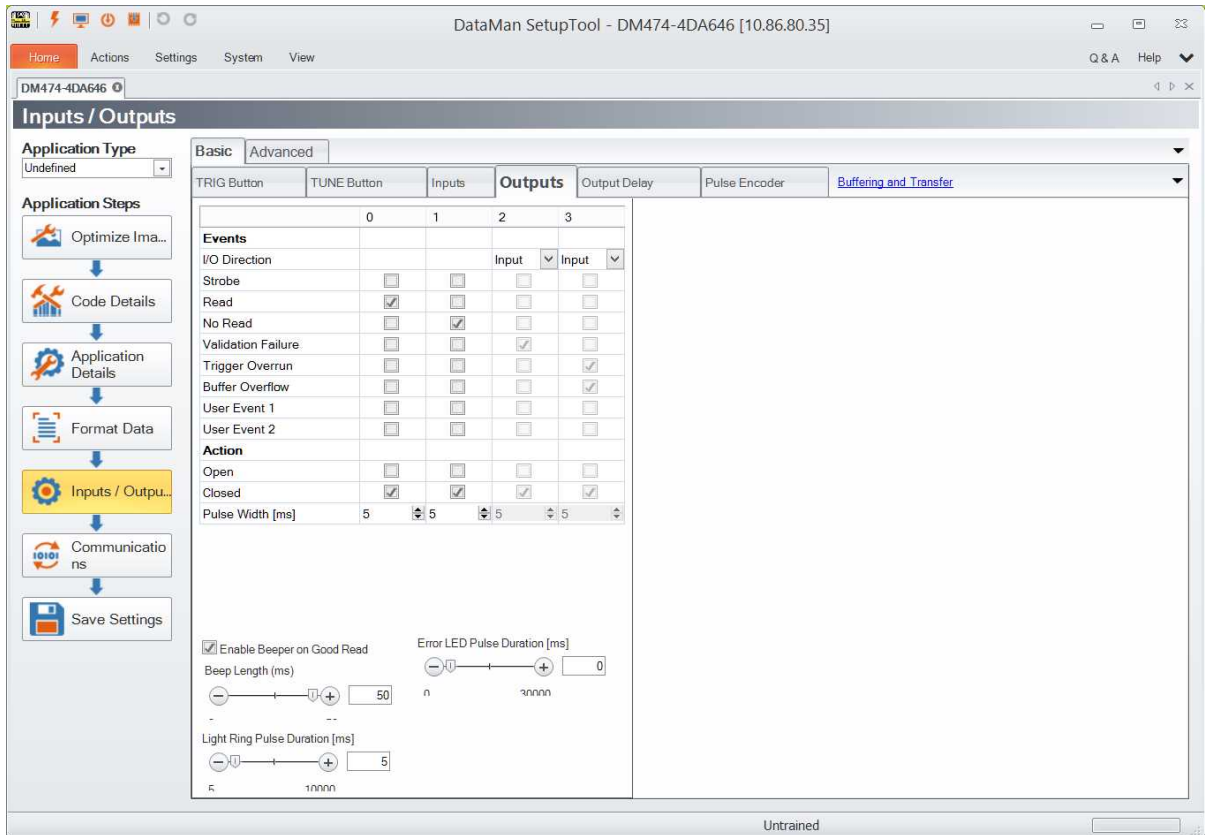

The **Advanced** tab provides you the following setting options:

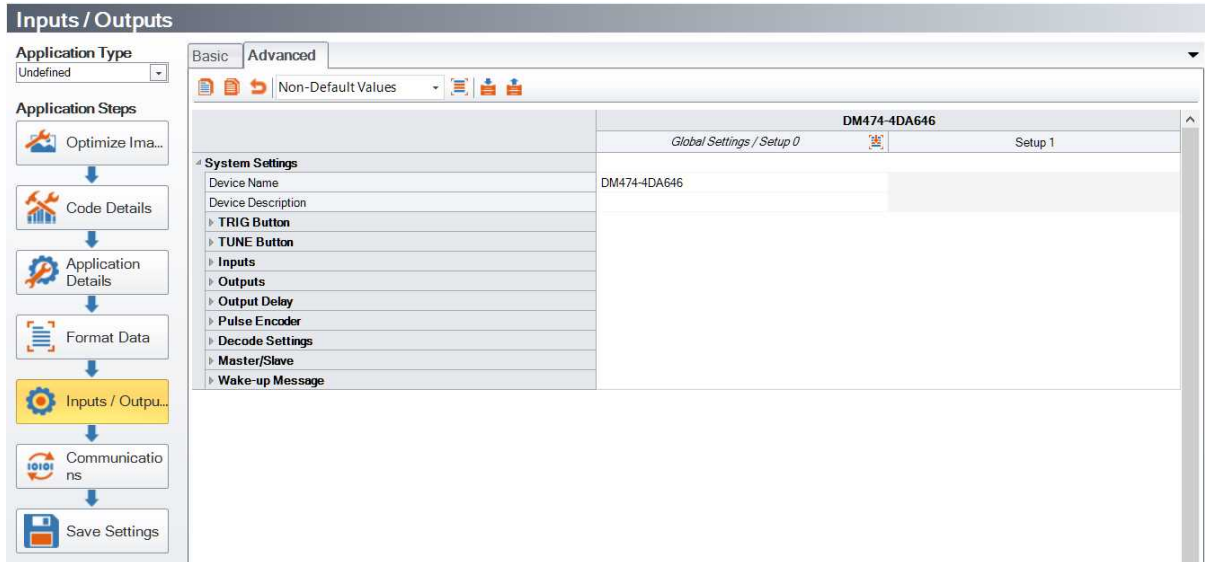

## Communications

All the communication ports data are set in this application step. Set the serial and ethernet data on the tabs with the same name.

**Communications**

Application Type: Undefined

Application Steps:

- Optimize Ima...
- Code Details
- Application Details
- Format Data
- Inputs / Outpu...
- Communications**
- Save Settings

Serial | Ethernet | **Advanced**

Serial Port Settings

Speed	115200
Parity	None
Data Bits	8
Stop Bits	1
RS 232 Inter-character Delay (ms)	0

**Communications**

Application Type: Undefined

Application Steps:

- Optimize Ima...
- Code Details
- Application Details
- Format Data
- Inputs / Outpu...
- Communications**
- Save Settings

Serial | Ethernet | **Advanced**

Use DHCP Server  
 Use Static IP Address

IP Address	10.86.80.0
Subnet Mask	255.255.255.0
Default Gateway	10.86.80.205

Copy PC Network Settings

Telnet

Telnet Port: 23

Industrial Protocols

EtherNet/IP™  
 PROFINET  
 SLMP Protoc  
 Modbus TCP

Only one protocol may be enabled.

Use Name of Station  
 Name of Station:

Status:

Network Client

Enabled  
 Host Address: : 1000

The **Advanced** tab provides you the following setting options:

The screenshot shows the 'Communications' window of the DataMan Setup Tool. On the left, a vertical sidebar contains 'Application Steps' with icons and labels: 'Optimize Ima...', 'Code Details', 'Application Details', 'Format Data', 'Inputs / Outpu...', 'Communications' (highlighted in yellow), and 'Save Settings'. The main area is divided into tabs: 'Serial', 'Ethernet', and 'Advanced'. The 'Advanced' tab is active, showing a table of settings for 'DM474-4DA646'. The table has columns for 'Global Settings / Setup 0' and 'Setup 1'. The 'Serial' section includes settings like Speed (115200), Parity (None), Data Bits (8), Stop Bits (1), and RS 232 Inter-character Delay (ms) (0). The 'Ethernet' section includes 'Use DHCP Server' (unchecked), IP Address (10.86.80.0), Subnet Mask (255.255.255.0), and Default Gateway (10.86.80.205). Other sections include 'Non-Printing Characters', 'Custom Commands', 'Network Settings', and 'Industrial Protocols'.

### Save Settings

This is an action button.

By clicking it, you can save all your configuration settings in one step.



## Settings

Under the **Settings** tab you can configure the following functions of the Setup Tool.

## Test Mode

**Note:** Platforms: DataMan 50, DataMan 60, DataMan 70, DataMan 150, DataMan 260, DataMan 300, DataMan 360, DataMan 474, DataMan 503

**Test Mode** lets you configure and test a reader that is connected to a production line without needing to slow down or stop your line. To enter **Test Mode**,

- Press the button (to which you previously assigned this function) on the device for 3 seconds
- Send a DataMan Control Command (DMCC)



- Click the **Enable Test Mode** button in the DataMan Setup Tool (**Actions** -> )

While in Test Mode, the reader by default ignores all external trigger sources and disables all input and output lines.

Check **Automatic Triggering Enabled**, and the reader will simulate external triggers at the interval that you specify.

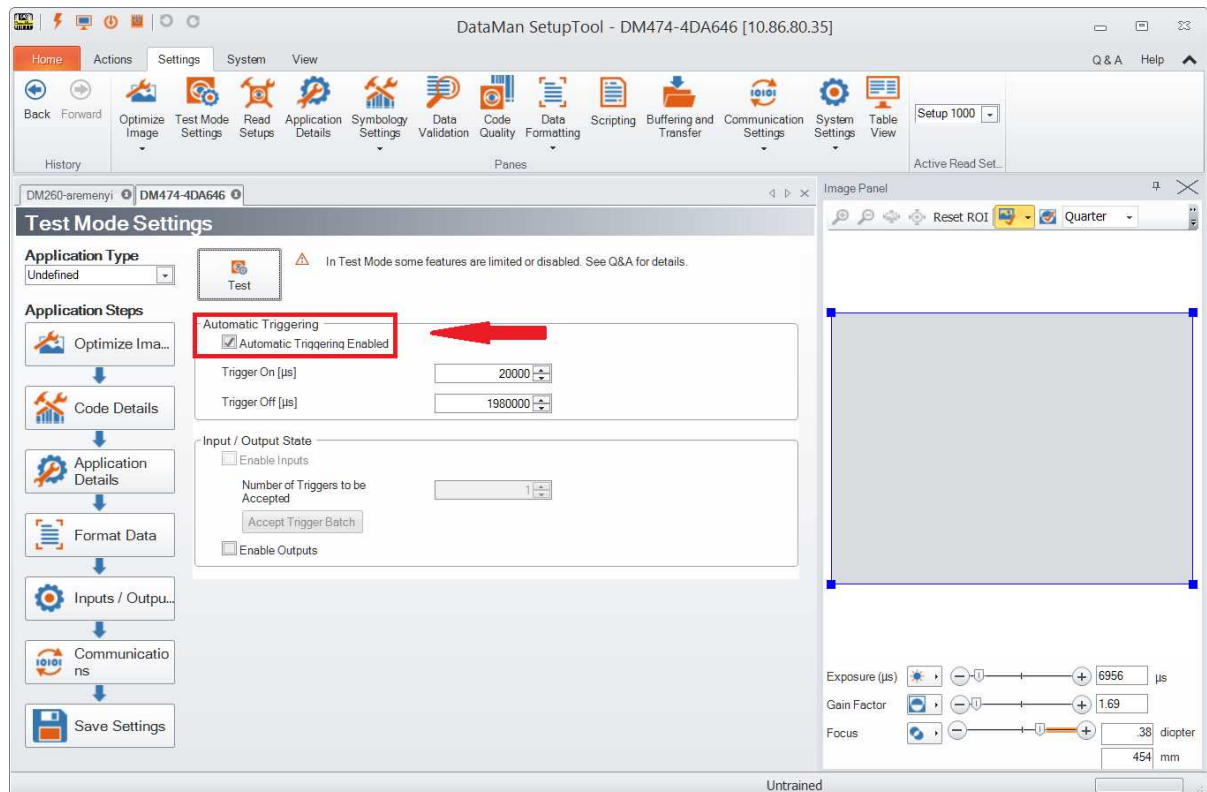

If Automatic Triggering is not enabled, click **Accept Trigger Batch** in the **Input / Output State** field, and the reader will accept and process a limited number of external triggers at production speed.

In both cases, you can view images and decodes using production settings, but at a slower rate and without sending output signals to your line.



DM474-4DA646	
Setup 0	Setup 1
Setup 10000000000000000000000000000...	Setup 0
<input checked="" type="checkbox"/>	<input checked="" type="checkbox"/>
2,000	2,000
200,000	5,000
251,18	251,18
2,000	3,489
2,32	5,37
<input checked="" type="checkbox"/>	<input checked="" type="checkbox"/>
15	15
(0, 0), (2048, 1536)	(0, 0), (2048, 1536)
No Filtering	No Filtering
Original	Original
Original	Original
Original	Original
Original	Original
0 (Fixed Focus)	0 (Fixed Focus)
8,74	15,00
0,38	1,97
<input checked="" type="checkbox"/>	<input checked="" type="checkbox"/>
IDMax	IDMax
<input checked="" type="checkbox"/>	<input type="checkbox"/>
<input checked="" type="checkbox"/>	<input type="checkbox"/>

The read setup process starts with either a specific setup, or the *Last Successful Decode* (as you choose).

The currently selected setup also gets represented on other panes. For example, you can check which is the active Read Setup in the Settings pane:



## Data Validation

**Data Validation** is used to confirm that the data encoded by a symbol is in the correct format for a particular company, industry or international standard.



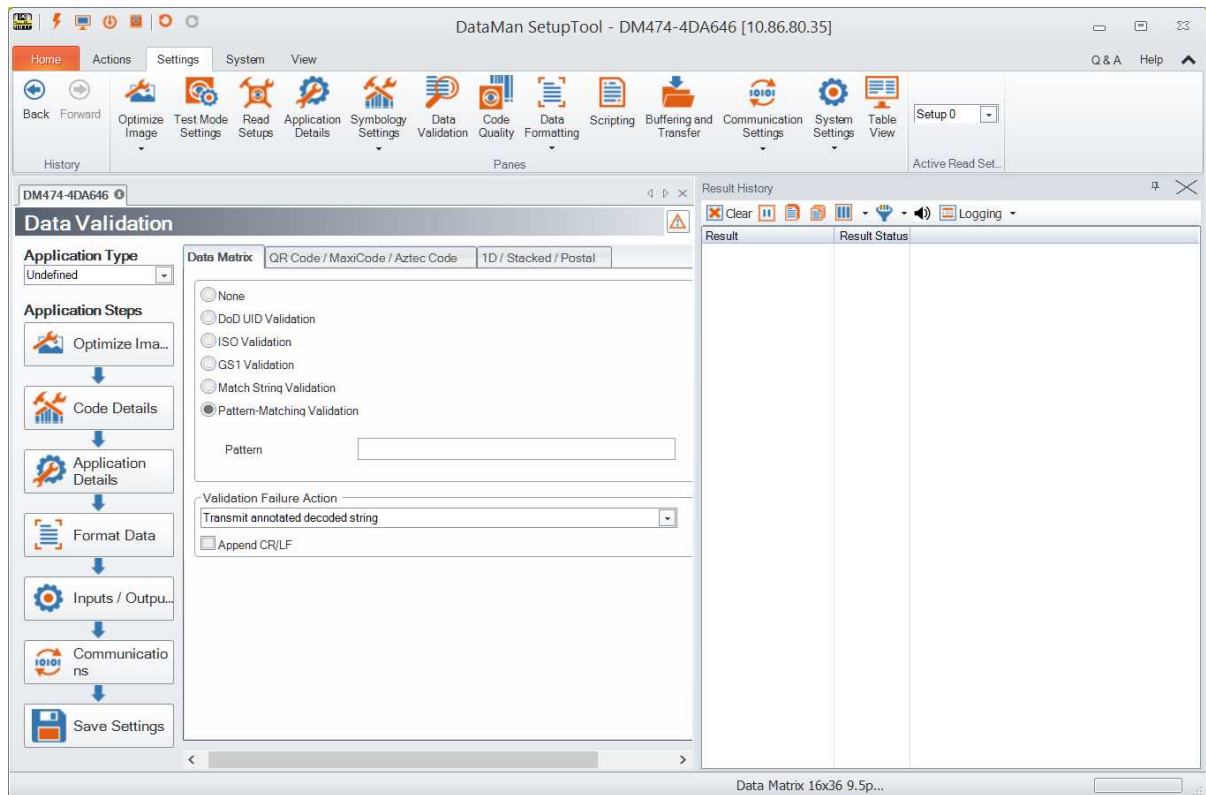

Data Matrix, QR Code/MaxiCode/Aztec Code and 1D/Stacked/Postal code categories can be validated against standards/well formedness.

## Code Quality

Under **Code Quality** you can set the desired code quality standard you want to use for quality assessment for your code type. Once you set this on the **General** tab, you can navigate to the appropriate code quality standard's sub-tab under the **1D Barcodes** or **2D Codes** tabs and customize for specific grades the grading thresholds, inclusion of specific grades in the overall grade and their display in the report.

**Note:** MicroQR is not supported for code quality grading.

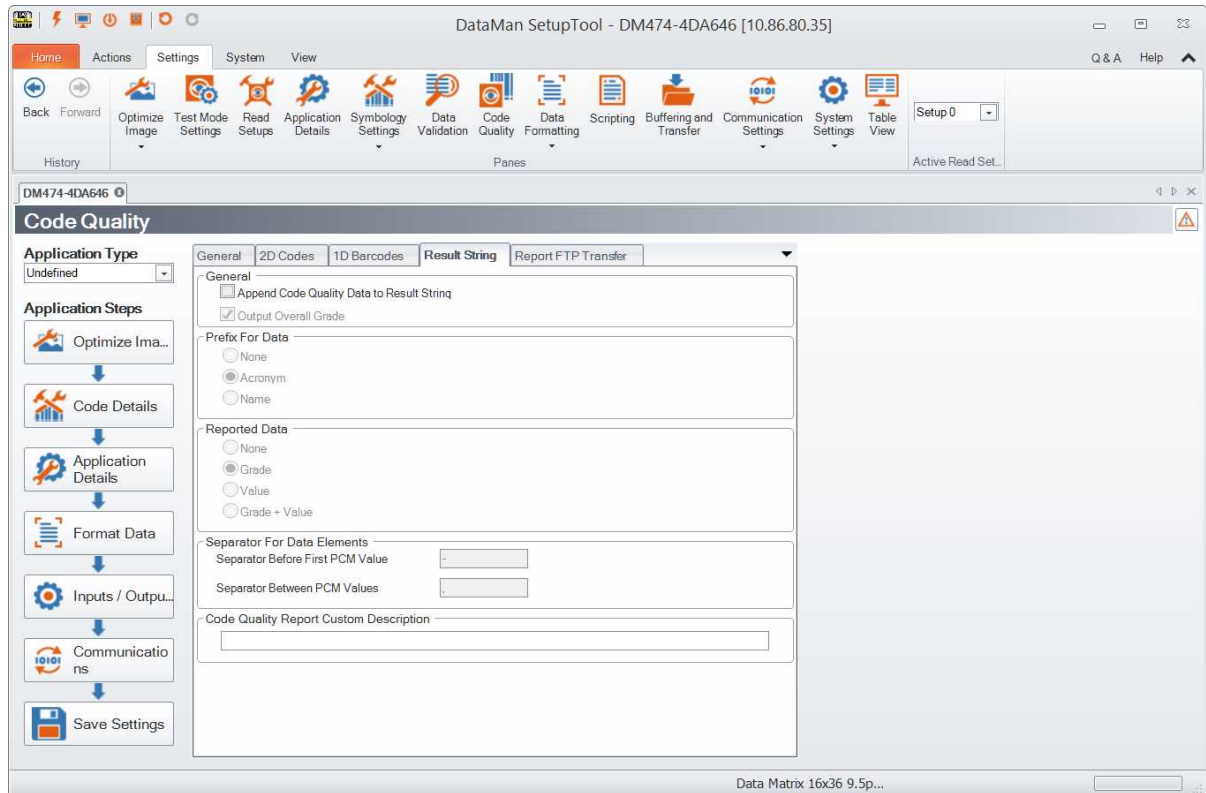

After you set up your device to compute **ISO/IEC 15415**, **AIM-DPM/ISO/IEC TR29158**, **SEMI T10**, or **DotCode for 2D Codes** (under the **General** tab in the **Code Quality** pane), the **2D Codes**, **1D Barcodes** tabs allow you to manage aspects of those types of code grading.

**Result String** tab: By ticking the checkbox **Append Code Quality Data to Result String**, you enable token based data formatting and allow code quality result data to be appended to result strings. If checked, the **Output Overall Grade** outputs the overall code quality grade (which is defined as the minimum grade of selected metrics) in the result string.

The **Report FTP Transfer** tab allows you to set up code quality results to be sent via FTP in form of an HTML report.

## Buffering and Transfer

**Buffering and Transfer** lets you control what images are recorded and saved on the reader, it lets you view images that are saved on the reader, and it lets you transfer those images to your PC.

- The **Image Buffering** tab lets you control what images to save to the reader.
- The **Image PC Transfer** tab lets you control how images are transferred from the reader to your PC.
- The **Image FTP Transfer** tab lets you set up automatic image transfers from the reader to your PC.
- The **Result FTP Transfer** tab lets you to configure the reader with the IP address and port number necessary to send decode results to an FTP server.

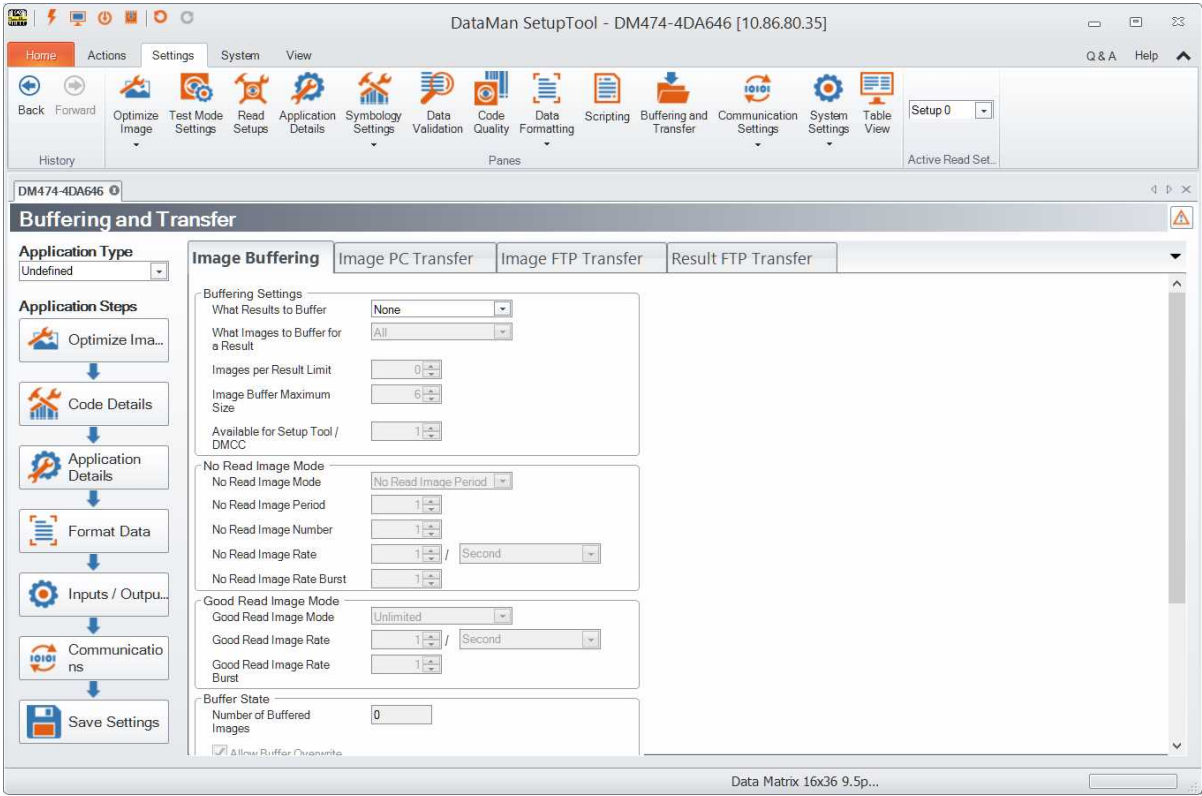

**Note:** The Buffering and Transfer function does not perform any decoding.

## Actions and System

After connecting to a device, the **Actions** and **System** tabs of the DataMan Setup Tool also become available.

On the Actions tab, you can set the input line and trigger the reader, enable live display, optimize brightness and focus, and tune the reader. You can also enable [Test Mode](#) here and show the device log or switch to the [Process Monitor](#). You can also load and train images and codes on this tab.

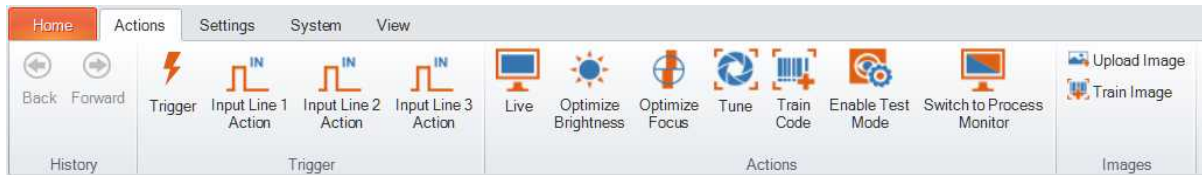

The System tab enables you to save and open configuration settings related to the device your Setup Tool is connected to. For more information on these options, see the **Qanda** document of the relevant device (or the **Q & A** pane in Setup Tool).

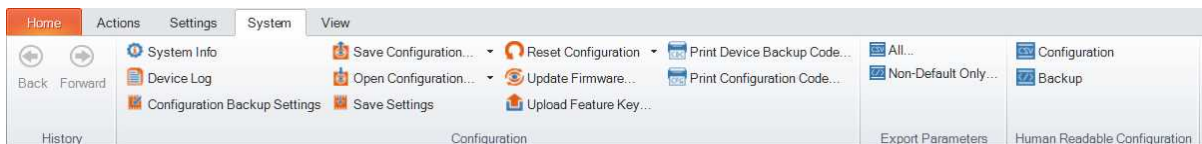

## View

The **View** tab helps you to display different views related to the data you want to check. The following options are available:

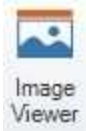

Opens the [Image Viewer](#) window.



Opens the **Image Panel** toolview where you can view the images read by the device.



Opens the **Result History** toolview in which you can view and log read results.

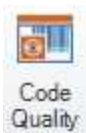

Displays the **Code Quality** toolview where you can do and view the necessary code quality settings.



Opens the [Q & A](#) pane in which you can see questions and answers related to the options appearing on the open document.

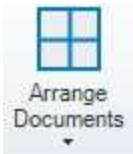

Clicking on the downward arrow belonging to this option, you can select the layout in which you want to display the panes you selected.



Clicking on this option results the same navigation steps you made occur in all open device documents.

## Image Viewer

The **Image Viewer** window can be docked in several places of the application, it can be pinned or set to auto-hide on mouse leave.

To open the Image viewer, select a reader in the [Connect](#) backstage page, connect to it, and go to the **View** tab. There,



click on the **Image Viewer** button to open the **Image Viewer** window:

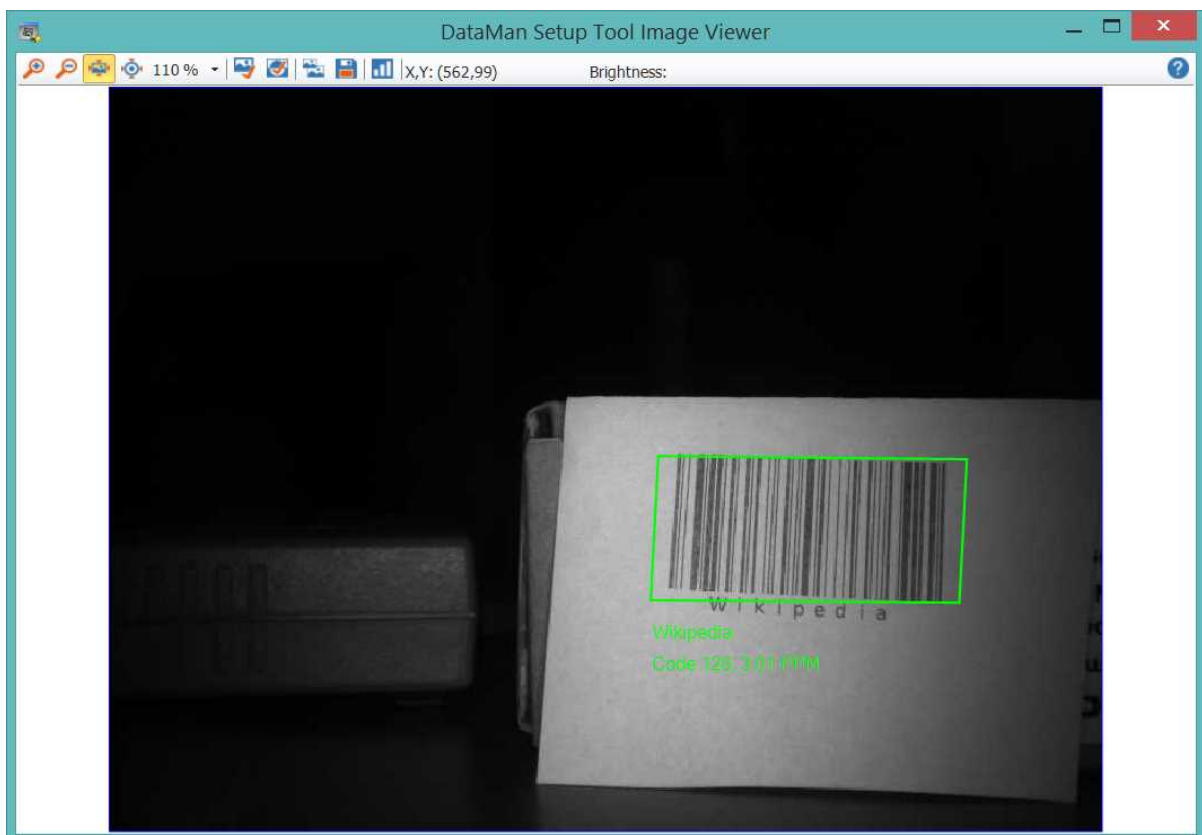

In this window, you can view the image read by your reader. The image is zoomable, it can be copied to the clipboard or saved to a selected folder. You can also select to check the histogram of the read image and the brightness data of a selected point in the image. Use the buttons on the toolbar ribbon of this window to carry out these tasks.

You can view the read image on the right hand side of the window: the Image Panel is always displayed by default. On



the **View** tab you can switch on and off by clicking the icon. This window can also be docked in different places of the application.

Example:

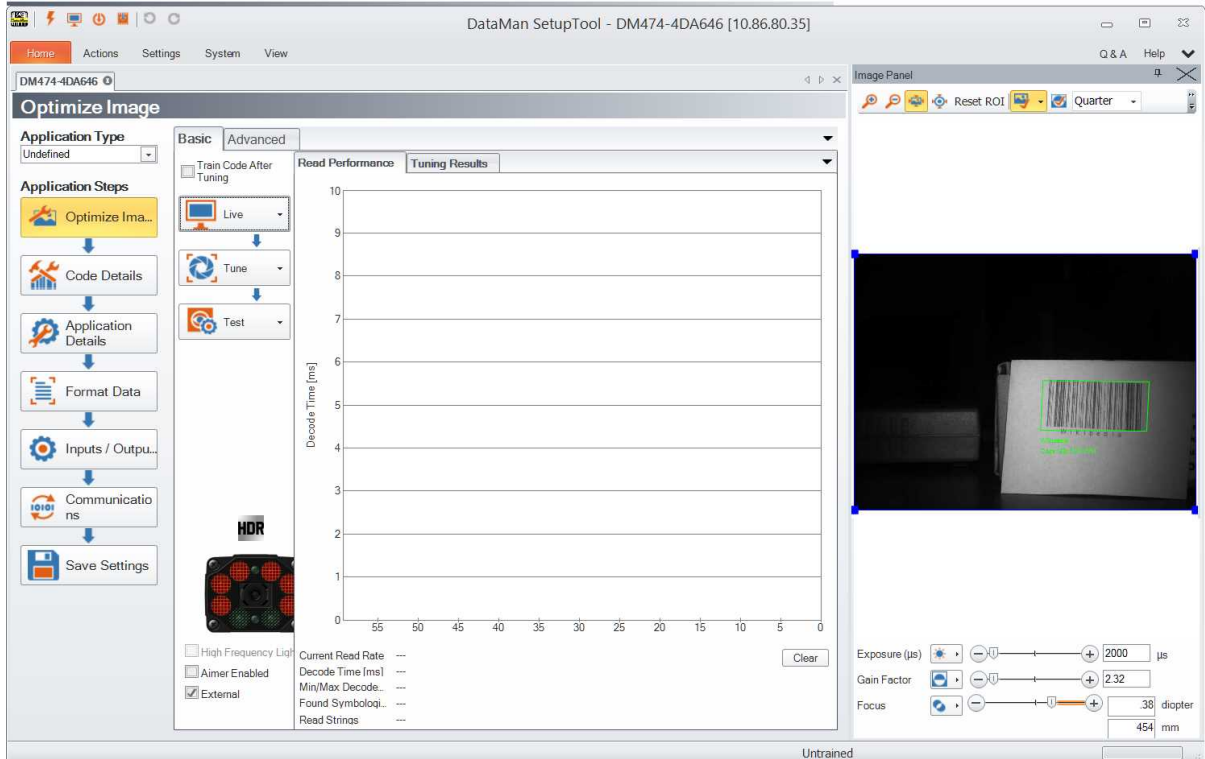

The same zooming options are available here as in the Image Viewer window, but you can also log no-read and decoded images to the file system from this pane using the Logging options (click the More Buttons drop-down arrow on the far right side of the Image Panel):

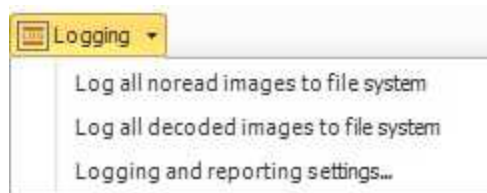

Clicking the last option here opens the [Setup Tool Options](#) window, in which you can set the default folder where logs of no-read and decoded images are to be saved.

Because of multi-reader support, several device document tabs can be open at a time, which means that there can be multiple image sources at the same time. Therefore, the **Image Viewer** receives image data only from the currently active device document. If the current document cannot provide image data (e.g. it is a [Reader Group Editor](#)), the content of the **Image Viewer** window will be empty.

## Results Viewer

Similarly to the [Image Viewer](#), the **Result History** pane can be configured in different layouts.

To open the Result History pane, select a reader in the [Connect](#) backstage page, connect to it, and go to the **View** tab.



There, click on the **Result History** button to open the **Result History** pane.

The result data comes from the currently active document if it can provide any. If not, then the **Result History** will be empty.

**Note:** Process Monitor and Reader Statistics provide *all* and not just the latest data, but in the case of the read images, only the latest ones are displayed.

The screenshot shows the DataMan Setup Tool interface. The main pane is titled "Optimize Image" and contains several sections: "Application Type" (Undefined), "Application Steps" (Optimize Image, Code Details, Application Details, Format Data, Inputs / Outputs, Communications, Save Settings), "Basic" and "Advanced" tabs, "Train Code After Tuning" checkbox, "Live", "Tune", and "Test" buttons, a camera icon, "Aimer Enabled" checkbox, and "External" checkbox. The "Read Performance" and "Tuning Results" graphs show Score vs. Brightness. The "Image Panel" shows a warning: "The reader is trained for Data Matrix 10x10 22.2ppm. Codes outside of these properties may not read." and a "Untrain Code" button. The "Result History" table is shown below.

Result	Result Status	Arrival T...	Tr
9:Z	Read	1:59:19.7...	22
9:Z	Read	1:59:18.1...	22
9:Z	Read	1:59:17.4...	22
	No read	1:59:06.5...	20
	No read	1:59:05.5...	20

At the bottom of the interface, the status bar shows "[1:59:19.704 PM] 9:Z" and "Data Matrix 10x10 22.2ppm".

You can customize the layout of this pane using the available options, that is, you can choose what data should be shown in the columns of the table.

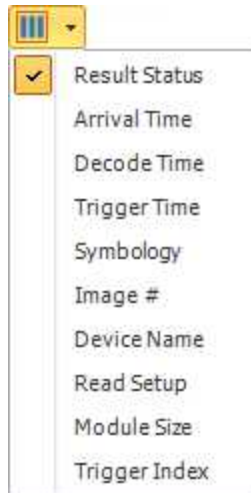

Select what you want to log from the Logging drop-down list:

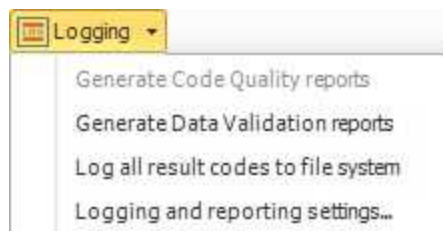

Clicking the last option here opens the [Setup Tool Options](#) window, in which you can set the default folder where reports and the logs of result codes are to be saved.



# Backstage Pages

The opening backstage page of the DataMan Setup Tool is [Connect](#), which was introduced earlier in this document. This section contains information about the other backstage pages: [Repair and Support](#), [Backup](#), [Restore](#), [Update Firmware](#), [Reader Groups](#) and [Image Playback](#).

## Maintenance

The **Maintenance** page can be used to set the network settings of a misconfigured network device or change the HID mode of a serial device to CDC, as well as for backing up and restoring device configurations, and updating firmware.

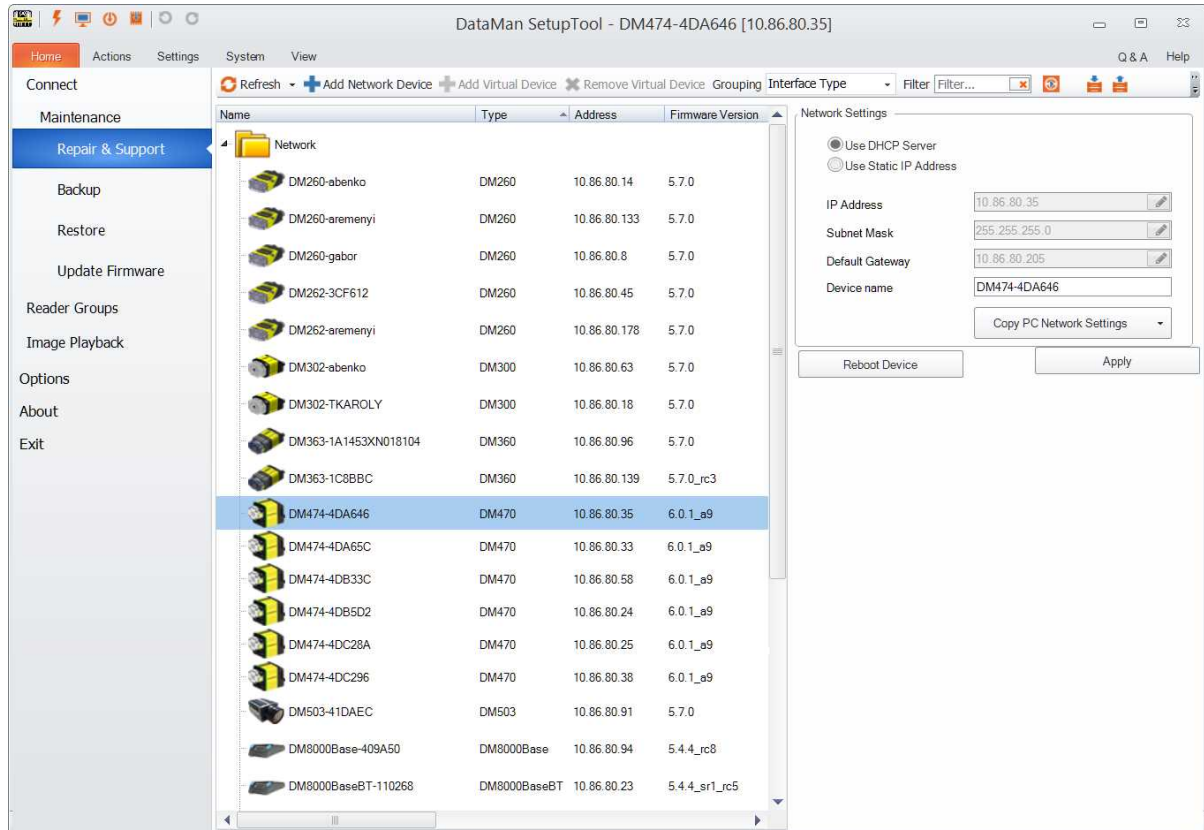

To be able to see the complete list of discovered devices, check the View Hidden option.

You can add a network device by clicking . The

**Add Network Device** dialog opens, where you can provide the necessary information (IP address of the device to be added). Click **OK** to save the changes and then **Refresh** to see the device added to the list.



## Virtual Devices

The **Add Virtual Device** function allows you to create a virtual device based on either a custom configuration file or a device with default configuration. This can be used to look at different panes in Setup Tool without the need of a device to connect to.

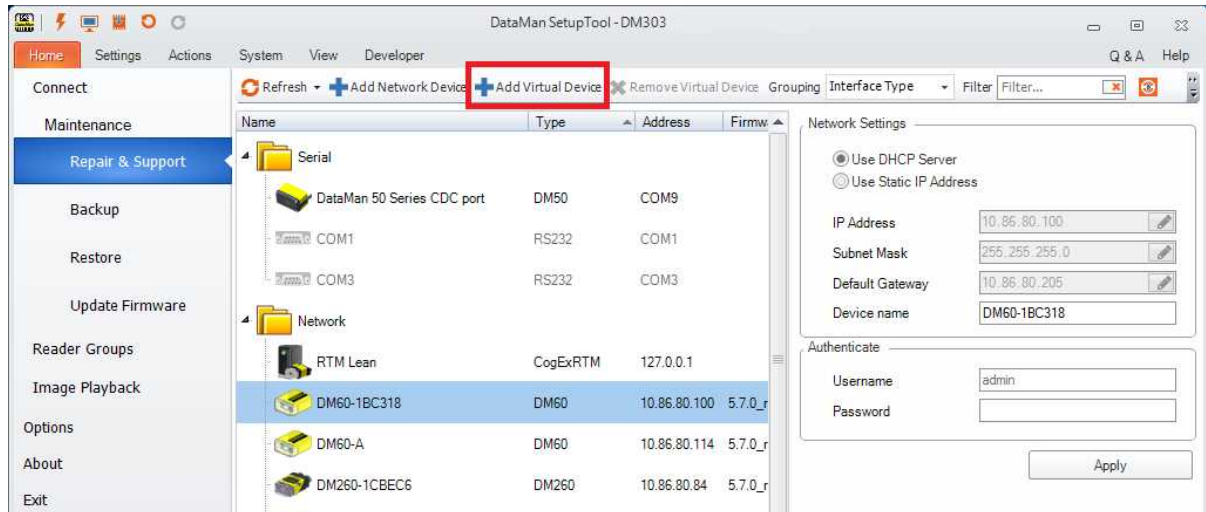

Pressing the button initiates a wizard that guides you through the steps of creating a virtual device. Initial options are to use a configuration/backup file for creation or use the factory default settings.

**Create Virtual Device**

**Device settings**  
Provide information about the virtual device.

Device name: DM303X-V0001

Device type: DM300 Series

Firmware version: 5.6.3

Device model: DM303X

< Back Finish Cancel

After the wizard is finished, a new virtual device is added to the list of discovered devices, indicated by a V icon as a

virtual device, for example . The created virtual device is not visible for other devices on the network. The virtual device persists during multiple Setup Tool instances.

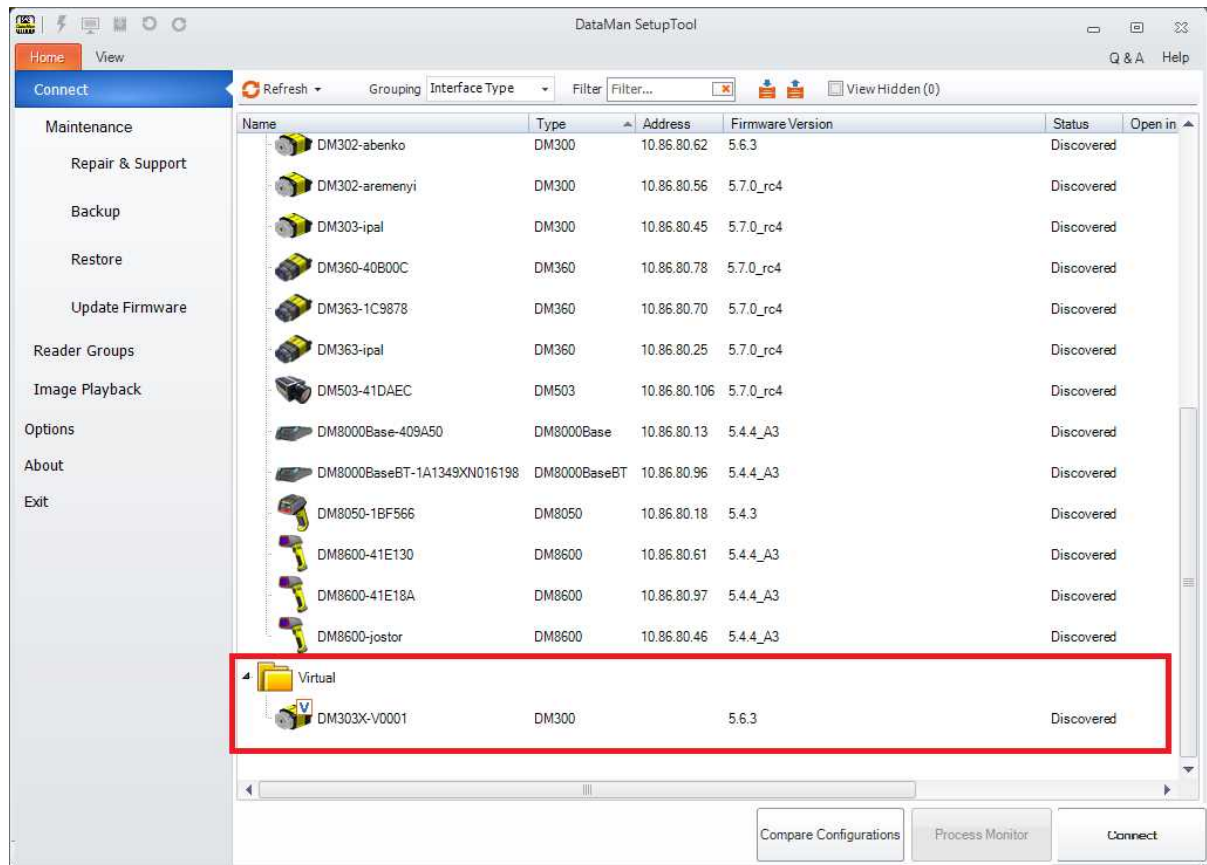

The created virtual device can be connected to the same way as a regular device, except that all configuration changes are rejected (everything is read-only) and no features, functions, and actions work on virtual devices.

## Backup

The **Backup** page can be used to generate a backup file containing the configuration and logs of one or more readers. To do so, highlight the device(s) you want to backup and click the **Backup** button on the lower right. You can find the backup files easily by clicking the **Open Backup Folder** button.

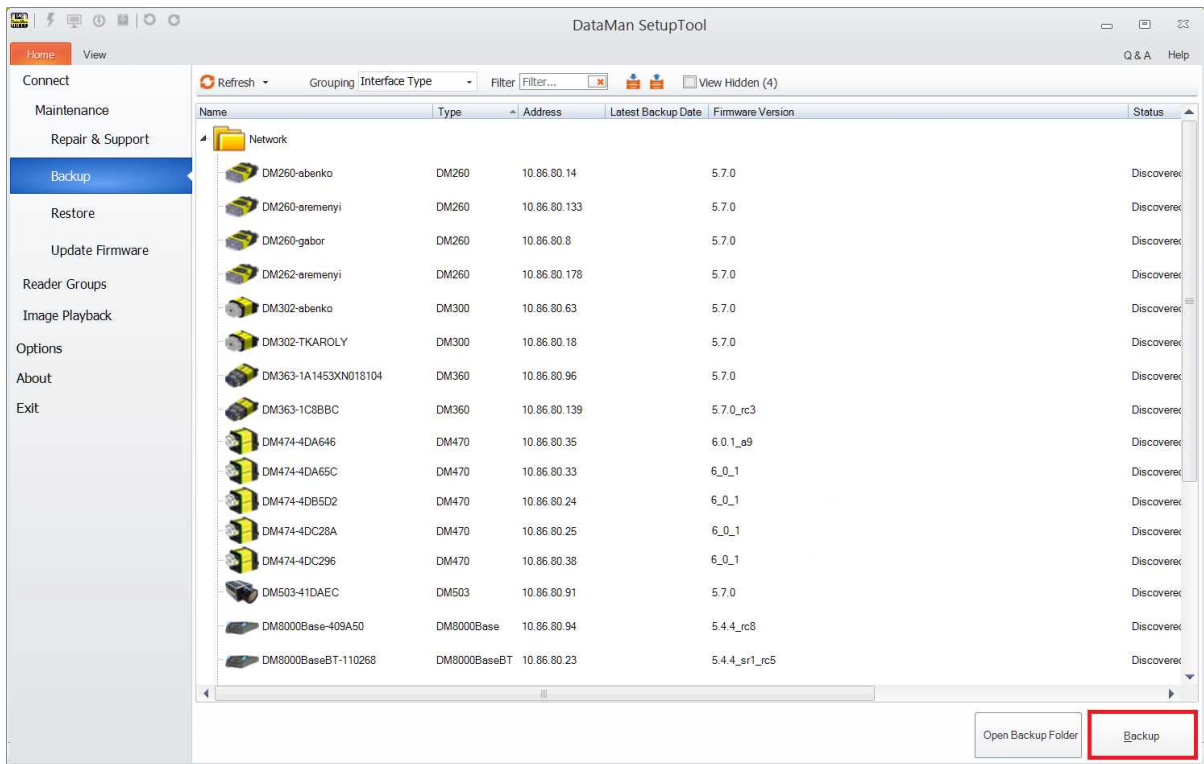

## Restore

The **Restore** page allows the restoration of backed up configuration files on one or more devices. This feature is only available if at least one device is selected and if a valid configuration source is specified. **Configuration Source** on top allows you to configure the source Setup Tool uses for restoration.

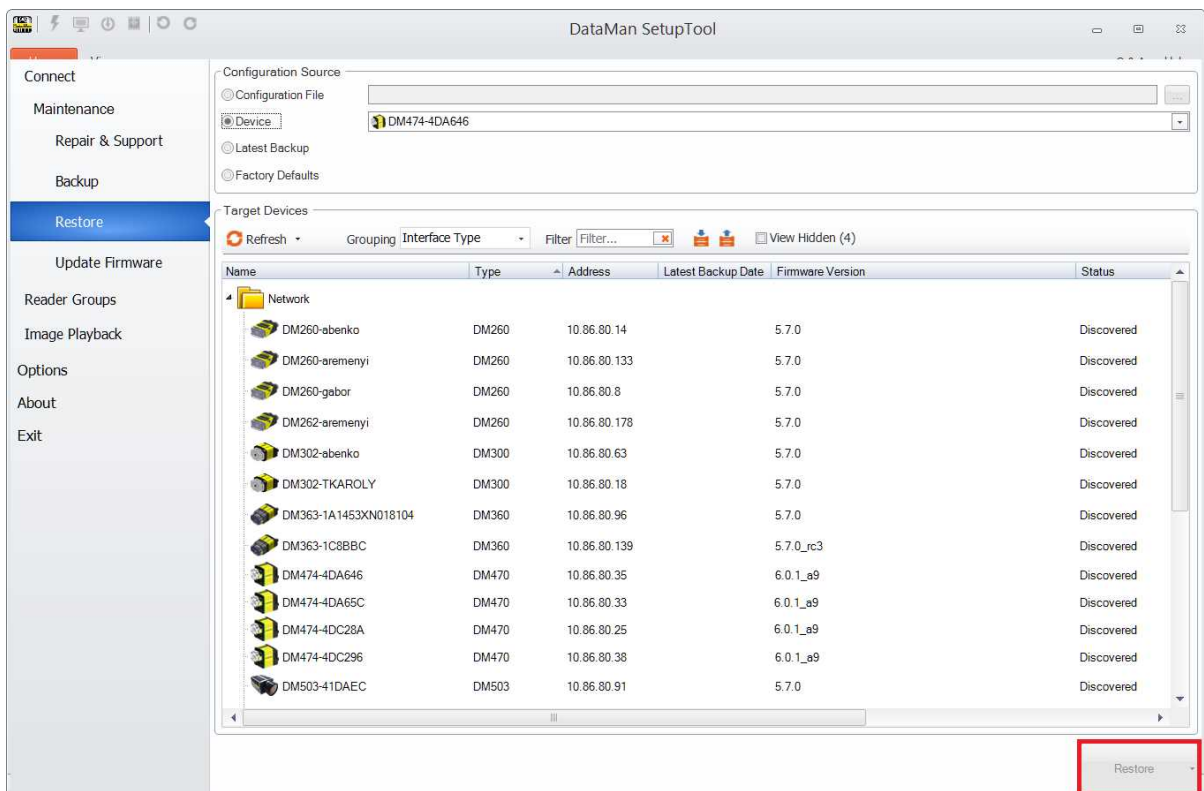

## Update Firmware

The **Update Firmware** page allows you to update the selected device or devices to the desired firmware version. Browse for firmware files by clicking the '...' icon, the pop-up window navigates to the right folder automatically. After selecting the firmware file, click the **Update Firmware** button to initiate the update.

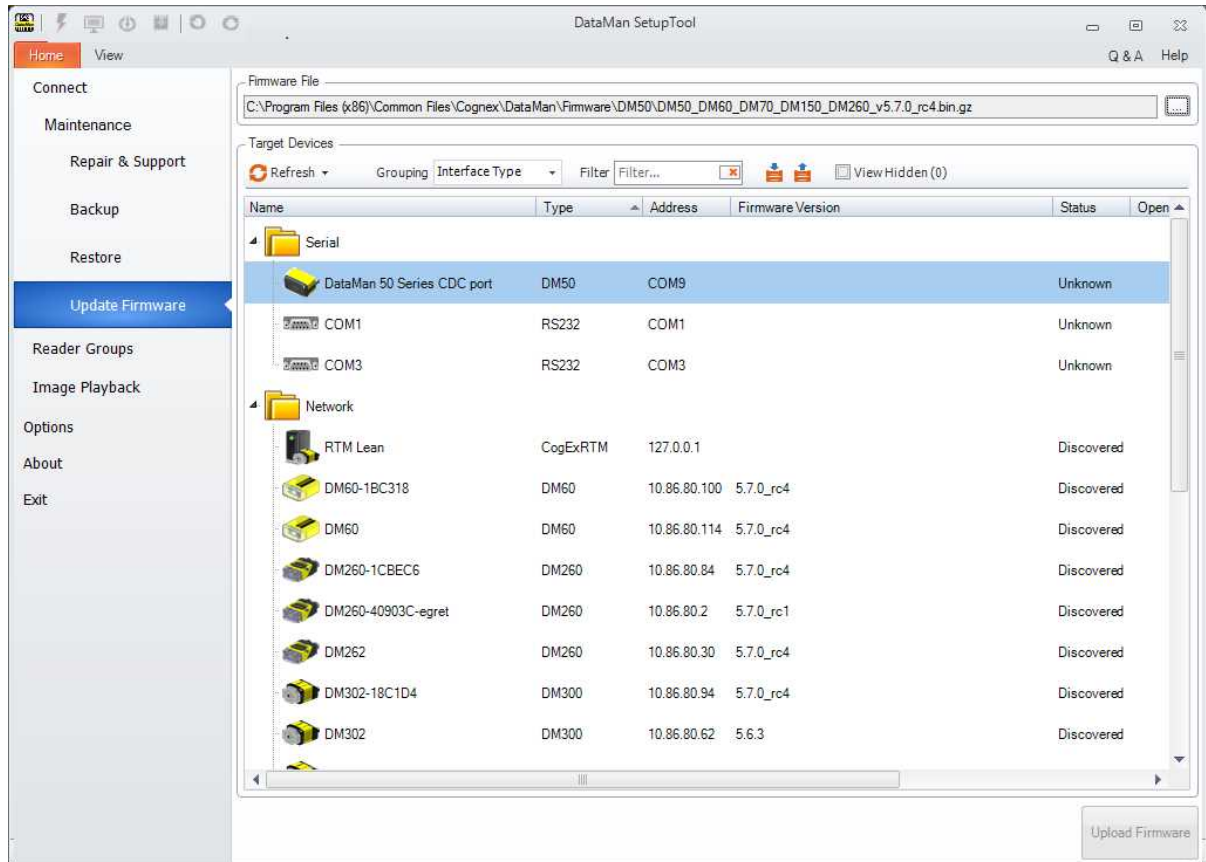

## Device Grouping

Device grouping helps you manage a larger number of devices, as well as define the Master-Slave groups in an easy way. The DataMan Setup Tool offers built-in groups on the device list page, (see the section on the [Connect](#) backstage page), and you can also specify your own custom groups. Creating a new user-defined group or editing an existing group can be started from the [Reader Groups](#) backstage page.

## Reader Groups

The available readers can be grouped on a custom basis and you can organize your readers in a custom tree. The list of already created custom groupings is shown on the left. When you select a custom group, it gets displayed on the right as a "preview".

*Example:*

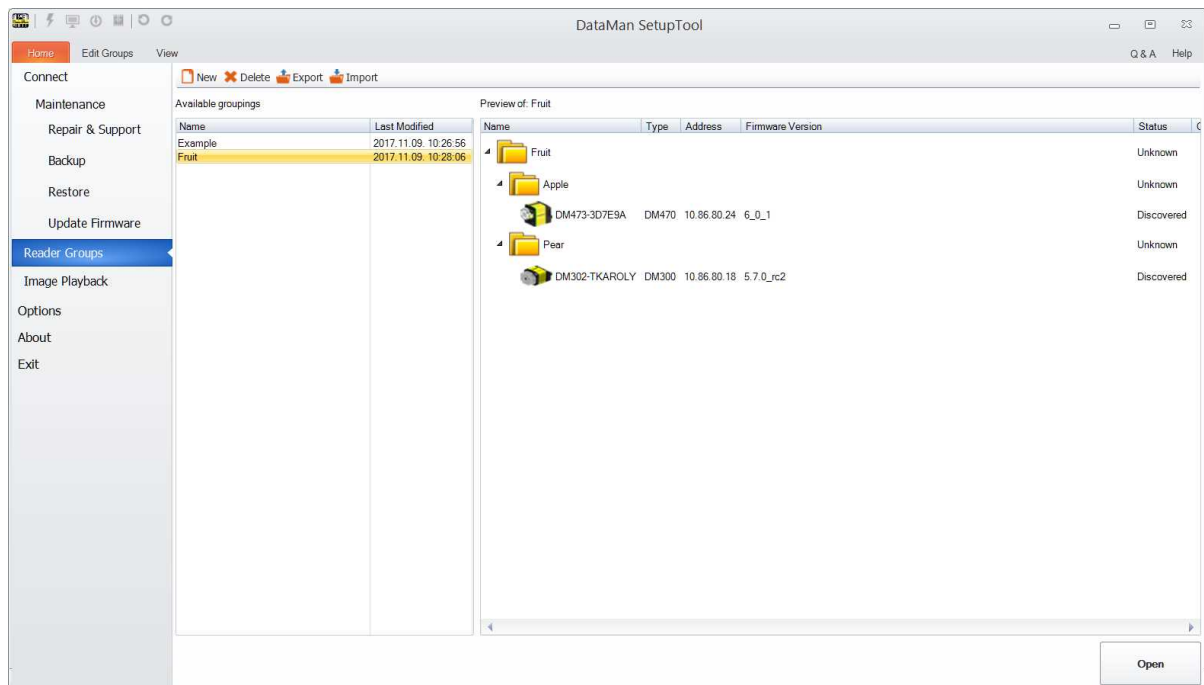

The following options are available on this page:



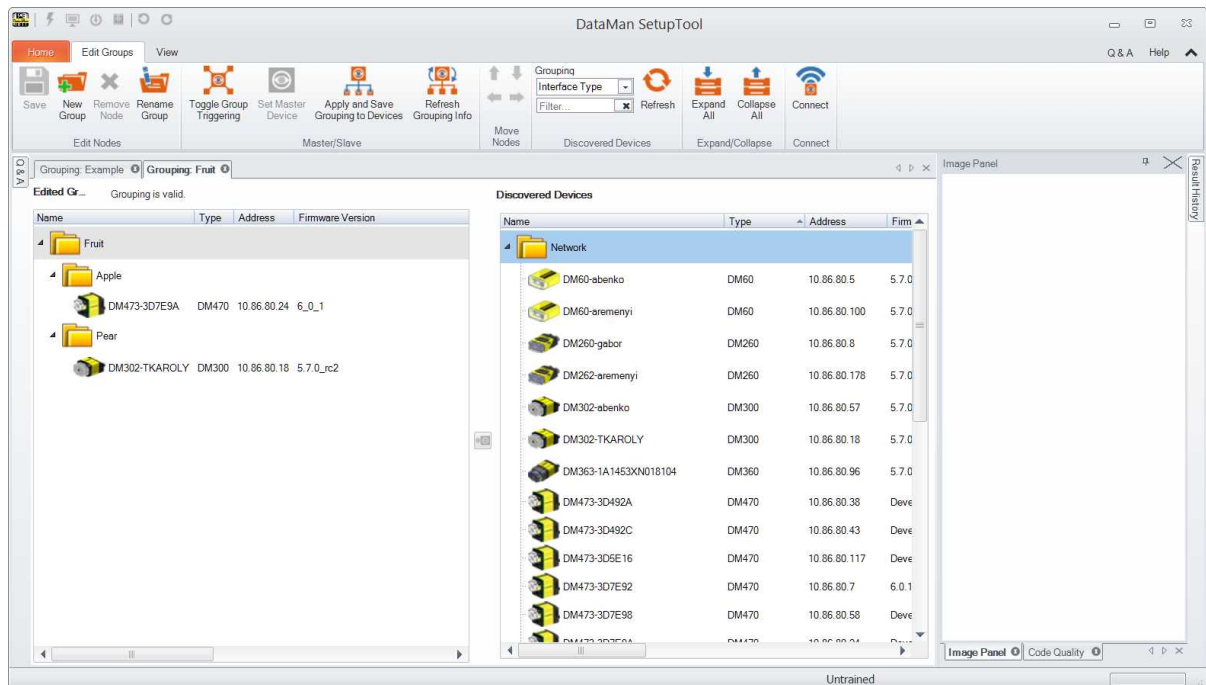

- Opening an existing group
- Creating a new group
- Deleting an existing group
- Exporting an existing group
- Importing saved groups to Setup Tool

## Custom Grouping

Custom groupings are displayed in a tree structure. You can select different nodes and start different operations on them with the buttons on the ribbon bar that belong to this type of document. The group editor tree supports drag and drop functionality, too. The group editor auto-hide ribbon appears by clicking the **Edit Groups** tab.







The group editor has two device tree controls: the one on the left is the tree of the currently edited group, whereas the one on the right is the list of discovered devices. Filtering, grouping and sorting is available on this device tree (see [Connect](#) for details). For group editing, the following options are available:

- Creating a new group node:** If a new group is created, it automatically gets a root node. The name of the root node is also the name of the custom group. For each group, there can be only one root node. To create a new group node, select the desired target node (which *must not* be a device node) and click the **New Group** button (  ).
- Adding a device to a group node:** Select one or more devices in the right-hand side device tree (Discovered Devices) and use the **Add Discovered Device(s)** (  ) button to add it to the currently selected group node on the left side (Edited Grouping). Alternatively, you can drag and drop a device from the right to the target grouping node on the left.
- Removing a device or group node:** Select the target node(s) on the left and click on the **Remove Node** (  ) button on the ribbon bar.
- Renaming a Group:** Click into the node's name, press F2 on the keyboard or click the **Rename Group** button (  ). In the case of a root node, the whole grouping gets renamed. After the renaming is initiated by one of these methods, the group name becomes editable in the tree.

- **Moving a node:** You can move a node in the edited tree. A node can be moved either up or down in its current



group, into the next group or out of the current one. After selecting the desired node to move, the option becomes available in the ribbon bar with the following arrows becoming green:

- Down : Move the node down among its siblings.
- Up : Move the node up among its siblings.
- Out of Current Group : Move the node up one level (out of the current group).
- Into Next group : Move the node down one level (into the next group).



Expand and collapse buttons (  ) are also available to expand or collapse the full tree, or you can expand or collapse specific nodes by clicking on the triangle left of the node.

## Managing Master-Slave Groups

In DataMan Setup Tool, master-slave configuration is part of the [grouping editor](#), but the ribbon bar also has tools to configure the master-slave trigger group. The following master-slave group management options are offered by Setup Tool:

- **Making a group to be a master-slave trigger (MST) group:** By selecting a valid group node (the name of the group is fit to be an MST group name) and pressing the **Toggle Group Triggering** button, the devices in the group are set to be part of the MST group with the name of the group node's name. This option is available only if *all* readers in the group support master-slave triggering.
- **Clearing a Master-Slave group triggering:** By selecting an MST group node and clicking the **Disable Group Triggering** button, the MST group entries are removed from all devices in the group.
- **Setting the Master device:** Some trigger modes may require to explicitly specify the master device. This can be achieved by selecting a device in a master-slave group and clicking on the **Set Master Device** button. This function is also available in the case of trigger types that do not require a specified master device, so it can be stored in the custom-edited grouping and be displayed at a later time.
- **Misconfigured MST groups:** It is possible that the data regarding master-slave group triggering becomes different in the device from what was stored in SetupTool II. Warnings appearing in such cases help you identify these issues. The warning messages are the following:
  - **Incompatible trigger types:** If the devices in the MST group have incompatible trigger types, the node of the MST group has a warning sub-node that displays this information. This is an error.

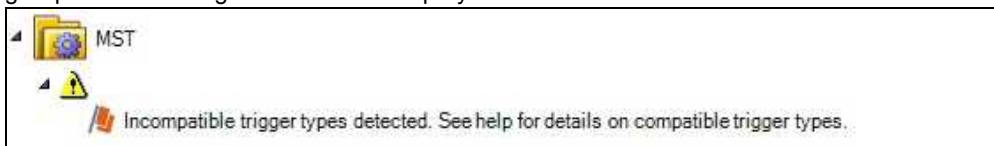



- **Master device not specified:** The MST group may not require a master device, but some trigger modes do require it, so this message is only shown as a warning.



- **MST group name mismatch:** It is possible that the MST group name stored in the device is different from what is stored in your own grouping. This is considered to be a major issue, so it is also shown as an error.



- **MST info not available:** Discovering exact information about master-slave trigger settings cannot be done without at least a "minimalist" connection. Until the valid information is retrieved by pressing the **Refresh** button, this information entry is shown for the device.

**Note:**

Icons:

-  error
-  warning
-  information

## Image Playback

For using the information in this backstage page, it is not necessary that a reader be connected to the DataMan Setup Tool. This page lets you control what images are recorded and saved on the PC, it lets you view images that were transferred to the computer as set in **Settings > Buffering & Transfer**.

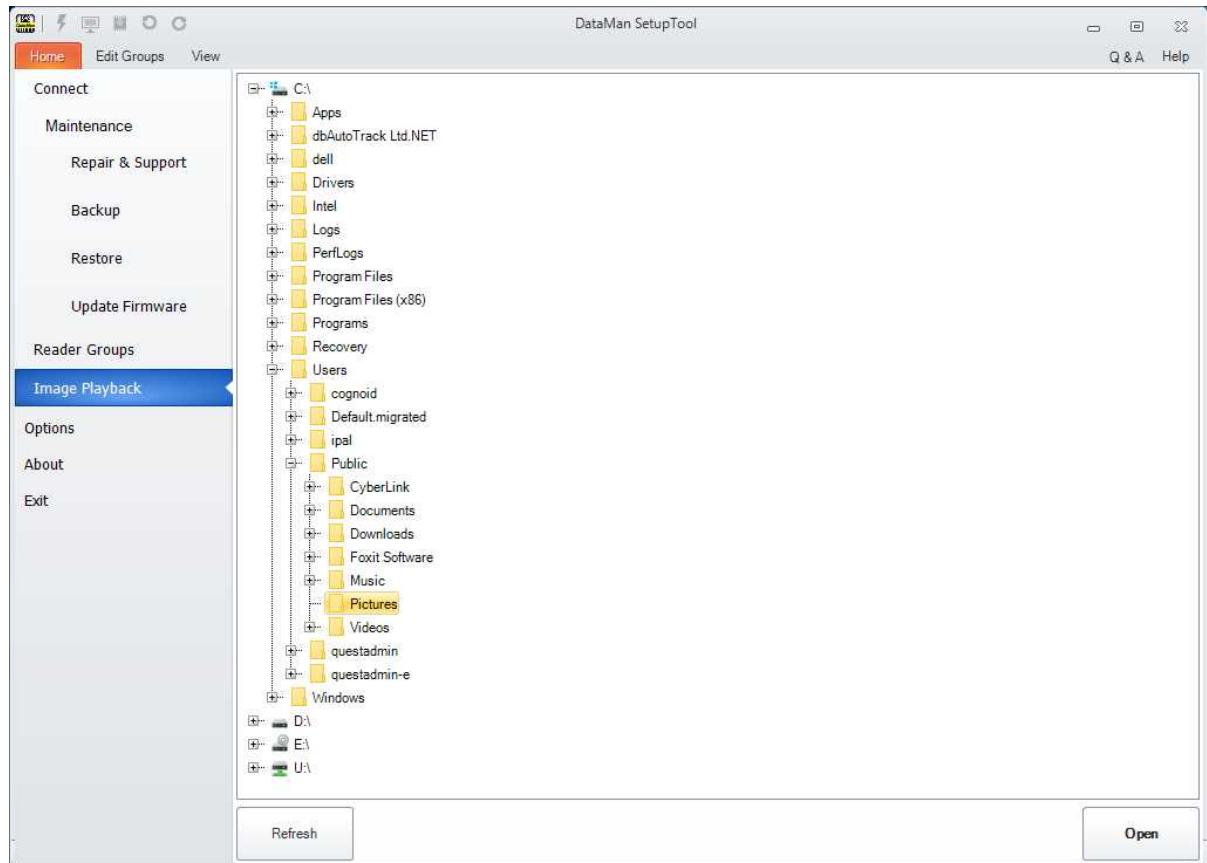

The images will be opened on the **Playback** tab:

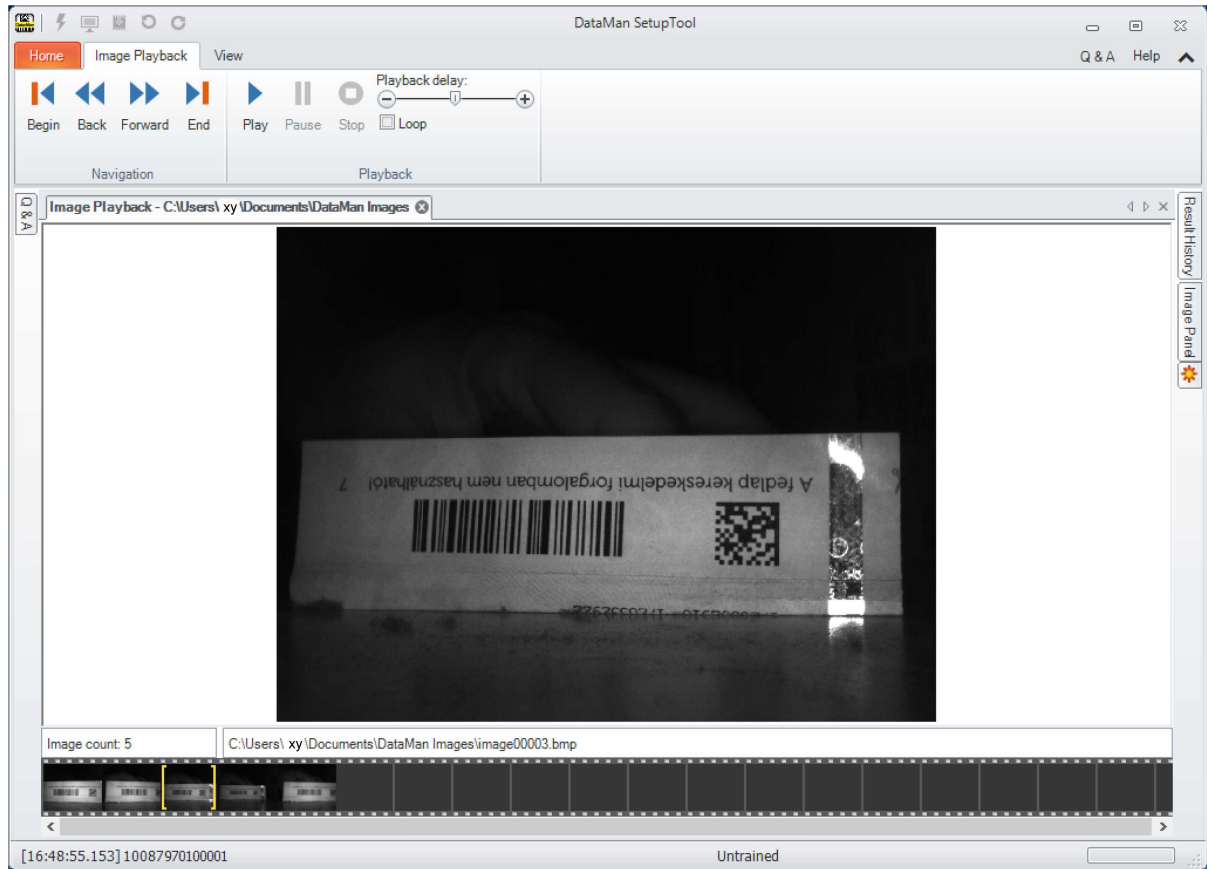

# Options

The **OptionsDialog** of the DataMan Setup Tool offers you to do settings in the application according to your preferences.

On the **General** tab, you can set the way according to which the read string will be decoded. Here, you can also select the color scheme (Silver, Blue or Black) of Setup Tool itself, and you can also select a category (Layout, Communication, Language, Codepage or Data logging) which you want to reset to defaults.

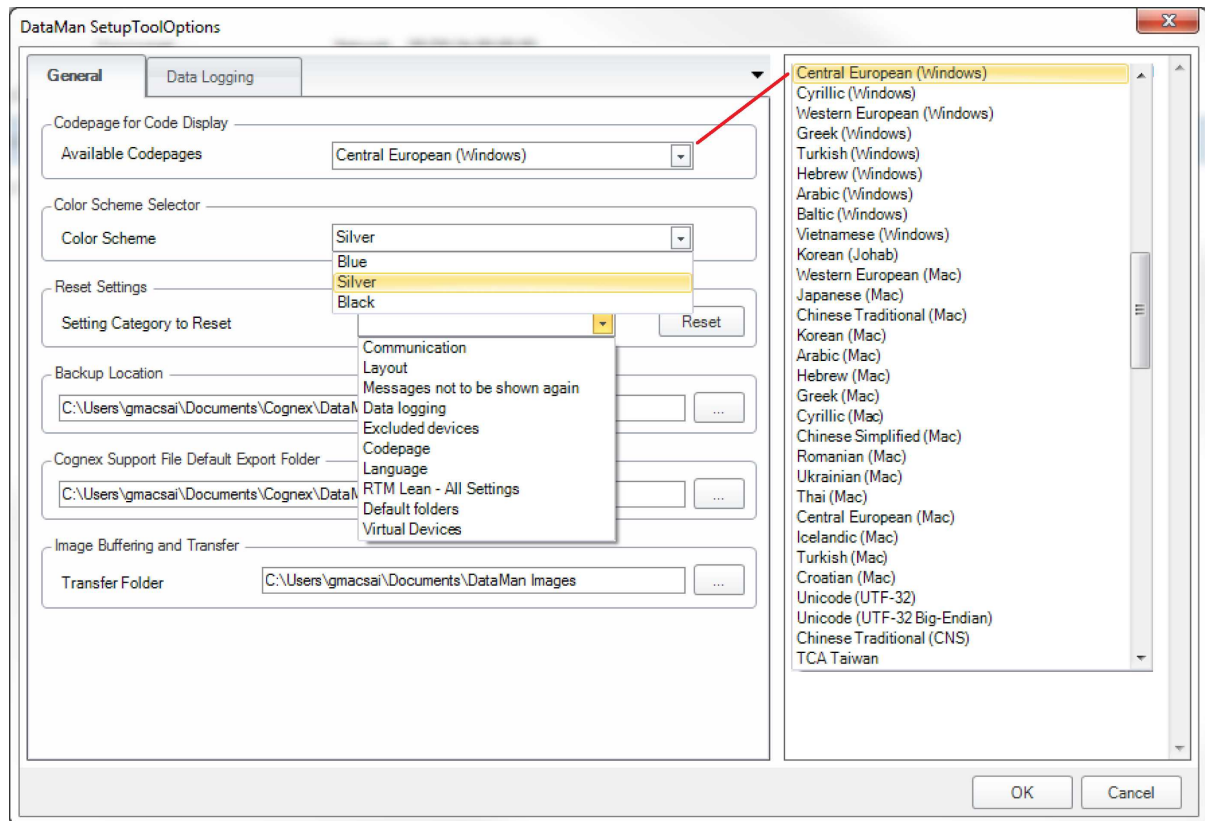

On the **Data Logging** tab, you can set the folders into which *result codes*, *decoded images*, *no-read images* and *reports* are to be saved.

DataMan SetupToolOptions

General | **Data Logging**

Result Code

Path: C:\Users\ xyz \Documents

File Name:

Decoded Images

Path: C:\Users\ xyz \Documents

Filename Prefix:

Include Overlay Graphics (SVG)

No Read Images

Path: C:\Users\ xyz \Documents

Filename Prefix:

Include Overlay Graphics (SVG)

Reporting

Path: C:\Users\ xyz \Documents

Filename Prefix:

Filename Structure: Include timestamp

Preferred File Extension: .pdf

Include Overlay Graphics (SVG)

**Options**

- What can I set in the Options page?
- What settings are available on the Data Logging tab?
- How can I enable the generation of data validation reports?

OK Cancel

# Help

When using the DataMan Setup Tool, a powerful help option helps you to find answers to your questions about the available options and settings.

Upon opening the DataMan Setup Tool, you will see a  button towards the top right corner of the window. By



clicking this, Setup Tool offers you the **About** option. Click on this button to view basic information on the Setup Tool version you currently use:



**Note:** This window is also available via the Home backstage by clicking **About**.

This option provides you with basic data about Setup Tool. However, you can also find information on the features and options provided in each tab, pane and document in Setup Tool.

Clicking the  button on a backstage page opens the Q & A related to that backstage page. For example, you will see the following questions when clicking this button on the [Reader Groups](#) backstage page:



Click on the little question mark icon in front of a question to see the relevant answer.

Or click  to open all the answers to the questions appearing in the Q & A pane.

After connecting to a device, you can access the Q & A pane related to each document and option if you navigate to the



**View** menu and click Q & A .

# Troubleshooting

## Image Acquisition

Symptom	Place	Solution
Image related properties cannot be changed.	Settings > Light and Imager Settings	Wait until the device finishes acquiring images or decoding, and try again.

## Communication

Symptom	Place	Solution
Setup Tool communications are corrupted.		Check the firewall or antivirus application installed on your computer. These can potentially interfere with Setup Tool communications. These communication issues can be fixed by allowing communication on the appropriate ports.
The reader does not appear in the list of <b>Discovered Devices</b> .	Connect Reader Maintenance	<ol style="list-style-type: none"> <li>1. Check your Ethernet connection with the reader and click <b>Refresh</b>.</li> <li>2. Scan the <i>Enable DHCP</i> code in the <b>Reader Configuration Codes</b> document available from the <b>Start</b> menu. This might allow the reader to acquire a suitable IP address from a DHCP server on your subnet.</li> <li>3. If the reader still does not appear, you can use the <i>Add Network Device</i> option in <b>Reader Maintenance</b>.</li> <li>4. You can also use the RS-232 connection to configure the reader with parameters that allow it to communicate over your Ethernet network.</li> </ol>



