

AG05

Actuator with RS485/SIKONETZ5 interface

User manual



Table of contents

1	General Information	4
1.1	Documentation	4
2	Block Diagram	4
3	Display and Control Keys.....	5
3.1	General	5
3.2	LCD display.....	5
3.3	LED displays	5
4	Functional Description	6
4.1	Control of the drive	6
4.1.1	Value input	6
4.1.2	Value selection	6
4.1.3	Operating modes.....	6
4.1.3.1	Positioning mode	6
4.1.3.1.1	Loop positioning.....	7
4.1.3.2	Inching operation.....	8
4.1.3.2.1	Inching mode 1	8
4.1.3.2.2	Inching mode2	8
4.1.3.3	Rotational speed mode.....	9
4.1.4	Current limiting	9
4.2	Manual control (stand-alone operation).....	10
4.2.1	Start inching mode 2.....	10
4.2.2	Specifying the set point and starting the travel order.....	10
4.2.2.1	Example: Starting positioning order to position 500	10
4.2.2.2	Example: Starting positioning order to position -500.....	10
4.3	Menu selection.....	12
4.3.1	Changeable parameters	13
4.3.1.1	Bus parameters	13
4.3.1.2	Positioning.....	14
4.3.1.3	Actuator.....	15
4.3.1.4	Limiting values	16
4.3.1.5	Visualization.....	16
4.3.1.6	Options.....	18
4.3.1.7	Controller parameters.....	19
4.3.2	Readable parameters	19
4.3.3	Error memory.....	20
5	Calibration	21
6	External gear.....	21
7	Warnings / Errors.....	22
7.1	Warnings.....	22

7.2	Errors.....	22
7.2.1	Error codes.....	22
7.3	Input errors.....	23
8	Parameter description.....	24
9	Service Protocol.....	33
9.1	General.....	33
9.2	System Status Word.....	33
9.2.1	Meaning of the bits.....	33
9.3	Service protocol commands list.....	35
9.4	Error number encoding.....	45
9.5	Flow chart: Operating mode: Positioning mode.....	46
9.6	Flow chart: Operating mode: Speed mode.....	47
10	Communication via SIKONETZ5.....	47
10.1	Interface.....	47
10.2	Data exchange.....	47
10.3	Telegram setup.....	48
10.3.1	Command.....	48
10.3.2	Node ID.....	48
10.3.3	Parameter address.....	48
10.3.4	Control word.....	48
10.3.5	Status word.....	48
10.3.6	Data.....	48
10.3.7	Check sum.....	49
10.4	Synchronization.....	49
10.5	Error telegram.....	49
10.5.1	SIKONETZ5 error codes.....	50
10.6	Errors.....	50
10.7	Communication monitoring.....	50
10.7.1	Bus Timeout.....	50
10.7.2	Locking the programming mode.....	51
10.8	Functional description of the control units.....	51
10.8.1	Control word: Positioning mode (master ⇒ slave).....	51
10.8.2	Status word: Positioning mode (slave ⇒ master).....	52
10.8.3	Flow chart: Positioning mode.....	53
10.8.4	Control word Operating mode: Speed mode.....	54
10.8.5	Status word: Speed mode.....	54
10.8.6	Flow chart: Operating mode: Speed mode.....	56
10.9	Parameterization via SIKONETZ5.....	56
10.9.1	Example: Read parameter.....	63
10.9.2	Example: Write parameter.....	64

1 General Information

1.1 Documentation

The following documents are associated with this document:

- The data sheet describes the technical data, the dimensions, the pin assignment, the accessories and the order key.
- The installation instructions describe the mechanical and electrical installation with all safety-relevant conditions and the associated technical specifications.
- The User manual for actuator commissioning and integration into a fieldbus system.

You can also download these documents at <http://www.siko-global.com/p/ag05>.

2 Block Diagram

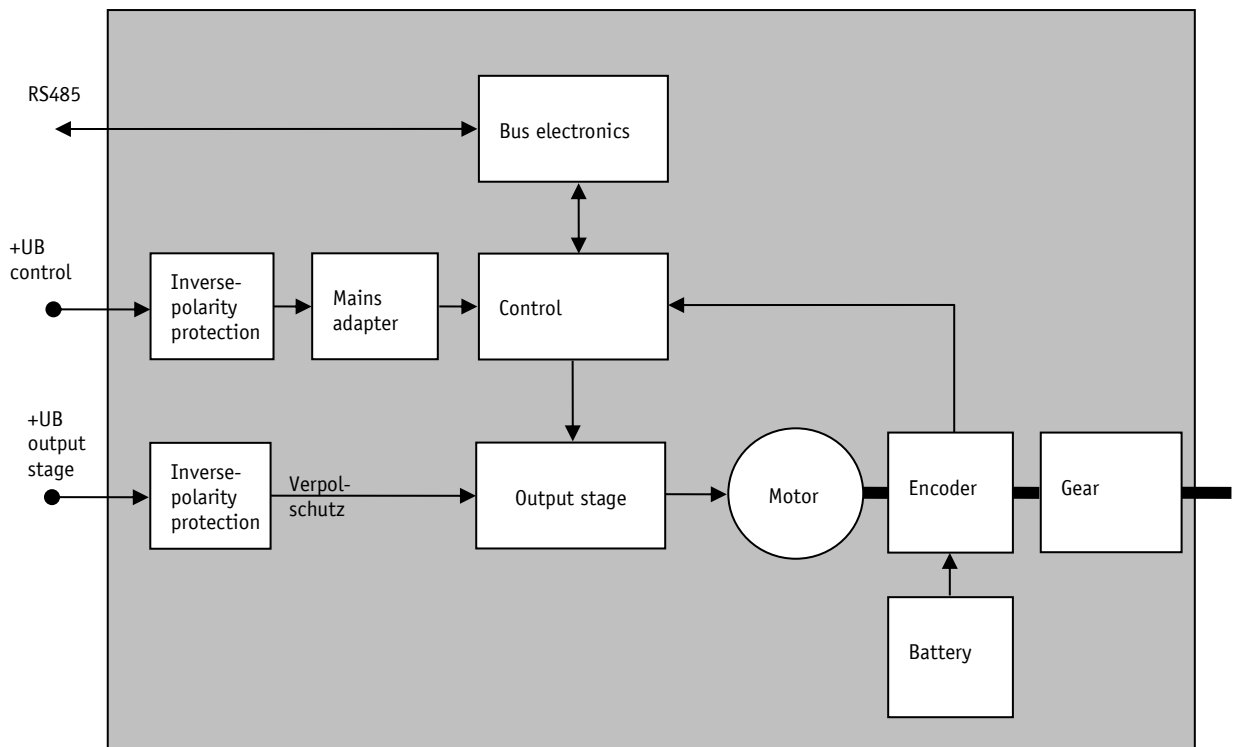

Fig. 1: Block diagram

3 Display and Control Keys

3.1 General

The actuator has a two-line display with special characters and three control keys. The keys serve for actuator parameterization and control. Two LEDs (1, 2) inform about the actuator's operating state.

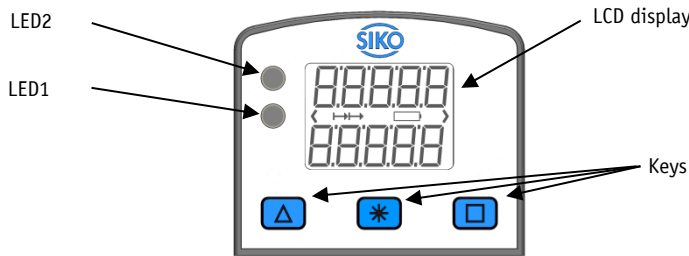

Fig. 2: Control elements

3.2 LCD display

With supply voltage applied to the control, the actual value is displayed in the first line and the set point value with factory settings in the second line.

The value displayed in the 2nd line can be adjusted via parameters.

3.3 LED displays

LED	Colour	State	Description
LED1	green	on	Actuator is within the programmed position window. Supply voltage of the output stage is applied.
		blinking	Actuator is within the programmed position window. Supply voltage of the output stage is missing.
		off	Actuator is outside the programmed position window.
	red	on	Actuator is outside the programmed position window. Supply voltage of the output stage is applied.
		blinking	Actuator is outside the programmed position window. Supply voltage of the output stage is missing.
		off	Actuator is within the programmed position window.
LED2	orange	on	Active bus operation
		off	No bus operation



Table 1: LED displays

4 Functional Description

4.1 Control of the drive

The drive can be controlled manually (stand-alone) and completely parameterized via the keys. In bus operation you can disable drive control via the keys.

4.1.1 Value input

Enter values via the  key and the  key. Confirm entered values by pressing the  key.

 - Decimal place selection key

 - Value input key

NOTICE	With value input via the keys, the display range is limited to -19999 ... 99999. When entering values beyond this range via SIKONETZ5 or the service protocol, "FULL" will be displayed when you select the parameter.
---------------	--

4.1.2 Value selection

For some parameters you can select values from a list. Direct value input is not possible.

You can select a value from the list via the  key. Confirm the value by pressing the  key.

4.1.3 Operating modes

The following operating modes are distinguished: positioning mode and speed mode. In the positioning mode there is the additional option of travelling in the inching mode.

4.1.3.1 Positioning mode

In the positioning mode, positioning to the specified set point is executed by means of a ramp function (see [Fig. 3](#)), calculated on the basis of the actual position as well as the programmed controller parameters P (proportional factor), I (integral factor), D (differential factor), acceleration and speed.

Upon activation of the travel order, the actuator accelerates to the specified speed with the acceleration programmed. The value of deceleration to the set point is defined by the parameter 'a-Pos' as well.

If the actual position is within the programmed window, this will be signalled by LED1, in the system status word and in the SIKONETZ5 status word. You can define the behaviour of the actuator upon reaching the programmed window.

Changing controller parameters during a positioning process does not influence the current positioning operation.

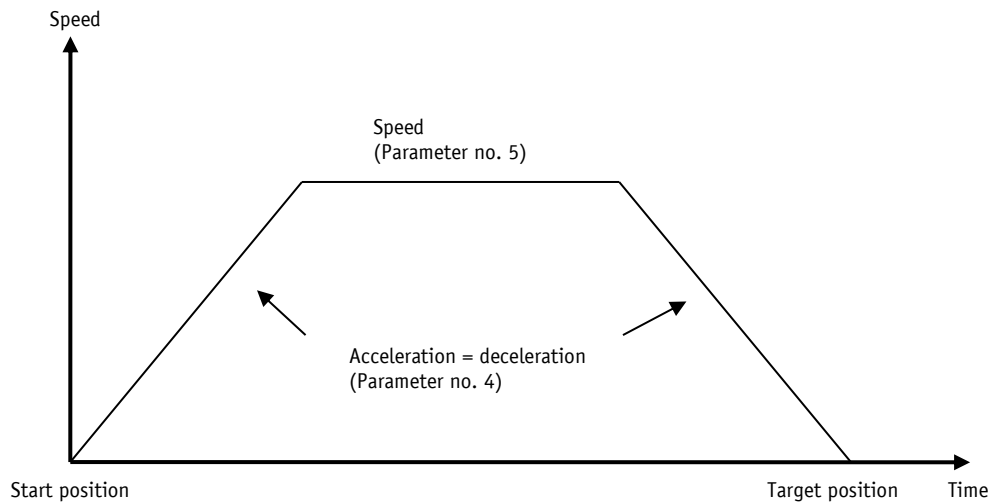

Fig. 3: Ramp travel, direct positioning mode

4.1.3.1.1 Loop positioning

If the actuator is operated on a spindle or an additional gear, the spindle or external gear backlash can be compensated by means of loop positioning. In this case, travelling to the target value is always from the same direction. This direction of approach can be defined.

Example:

The direction from which every target position shall be driven to is positive.

- Case 1 \Rightarrow new position is greater than actual position:
Direct travel to the target position
- Case 2 \Rightarrow new position is smaller than actual position:
The actuator drives beyond the target position by the loop length; afterwards, the set point is approached in positive direction.

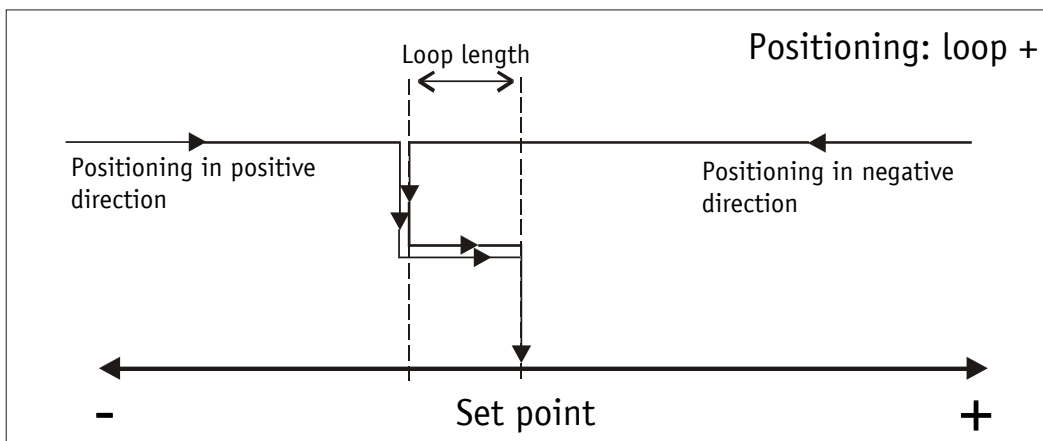

Fig. 4: Positioning Loop+

4.1.3.2 Inching operation

Inching operation is enabled in the 'positioning mode' only. You can program via parameters acceleration as well as speed in the inching mode.

NOTICE	There is no compensation for spindle play (loop positioning) in this operating mode.
---------------	--

4.1.3.2.1 Inching mode 1

The drive travels once from the current actual position by the position 'Delta Tipp' depending on the mathematical sign of the value entered.

'Delta Tipp' <0: negative travel direction

'Delta Tipp' >0: positive travel direction

NOTICE	If the 'Spindle pitch' parameter is programmed to zero, then the travelling way occurs by increments. If 'Spindle pitch' is unequal zero, then the information of the 'Delta Tipp' parameter refers to the travel distance in 1/100 mm.
---------------	---

Reaching of the target position will be signalled accordingly.

The following conditions must be met for enabling the start of inching modes 1 and 2:

- The actuator must not be switched to error
- No active travel job
- Supply voltage of the output stage is applied

NOTICE	If the actual position is outside the programmed limiting values, then travelling from this position in the respective direction is possible by means of inching mode 1 or 2!
---------------	---

4.1.3.2.2 Inching mode2

The actuator travels from the current position as long as the relevant command is active. You can influence the inching speed via two parameters and it will be calculated in the actuator as illustrated in the example below:

$v - \text{Tipp}$ (Parameter no. 9) = 10 rpm (can only be changed in the idle state)

Offset inching 2 (Parameter no. 30) = 85 % (can be changed during inching operation)

The resulting inching speed in this example will be:

Inching speed = $v - \text{Tipp} * \text{Offset inching 2} = 10 \text{ rpm} * 85 \% = 9 \text{ rpm}$

The results are always rounded to integers. The minimum speed is 1 rpm.

4.1.3.3 Rotational speed mode

With the set point enabled, the actuator when in the rotational speed mode accelerates to the target speed and maintains this speed until the set point is disabled or a different target speed specified.

The speed is adjusted immediately to the new value when the rotational target speed is changed.

The arithmetical sign of the set point determines the travel direction in the rotational speed mode.

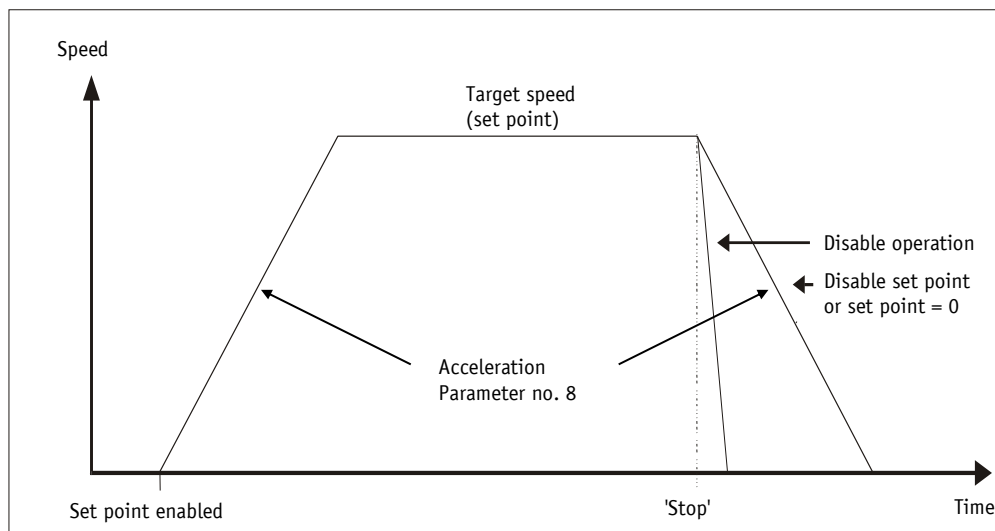

Fig. 5: Ramp rotational speed mode

The following conditions must be met for enabling the start of the rotational speed mode:

- The actuator must not be switched to error
- No active travel job
- Supply voltage of the output stage is applied

NOTICE

Limits 1 + 2 are inactivated in this operational mode.

4.1.4 Current limiting

The actuator is equipped with adjustable current limiting, which serves primarily for protecting the actuator against overload.

With the default value set, the nominal speed indicated on the data sheet is achieved.

Actuator overload results in limiting the motor current to the set value.

As a consequence, the actuator cannot maintain the speed set, the contouring error increases. With the contouring error exceeding the contouring error limit the actuator will enter the state of error: contouring error.

NOTICE

The actual motor current cannot be stated by measuring the supply current. With cycled output stages, the supply current does not correspond to the motor current. The actual motor current can be read out via the interface or indicated on the display.

4.2 Manual control (stand-alone operation)

4.2.1 Start inching mode 2

After applying supply voltage, the actuator will be on the uppermost level of the menu structure (default/delivery state). Positioning mode is active.

Pressing the  key starts left-hand motion (inching operation 2).

Pressing the  key starts right-hand motion (inching operation 2).

Releasing the respective key stops travel movement.











Pressing the  key starts the parameterization/programming mode.

4.2.2 Specifying the set point and starting the travel order

4.2.2.1 Example: Starting positioning order to position 500

Preconditions:

- The display is at the uppermost level of the menu structure (basic state).
- Operating mode: Positioning mode
- Key functions: enabled







	Initial state: normal display First press the  key, then the  key and hold down together.
	The key enable time is counted down.
	After expiry of the key enable time, the input field is released. The first decimal place is active. Press the  key twice to change the active decimal place.
	The third decimal place is active. Press the  key 5 times.
	Value 500 will be displayed. Confirm by pressing the  key to start positioning.

4.2.2.2 Example: Starting positioning order to position -500

Preconditions:

- The display is at the uppermost level of the menu structure (basic state).
- Operating mode: Positioning mode
- Key functions: enabled

NOTICE	For negative values to be entered, set first the value and only afterwards the arithmetical sign. The value 0 cannot be entered.
---------------	--

0 0	Initial state: normal display First press the  key, then the  key and hold down together.
⌚⌚⌚⌚ 3	The key enable time is counted down.
⌚⌚⌚⌚ 00000	After expiry of the key enable time, the input field is released The first decimal place is active and blinks. Press the  key twice to change the active decimal place.
⌚⌚⌚⌚ 00000	The third decimal place is active and blinks. Press the  key 5 times for entering the value.
⌚⌚⌚⌚ 00500	Value 500 will be displayed. Press the  key twice to change the active decimal place.
⌚⌚⌚⌚ 00500	The fifth decimal place is active and blinks. Press the  key 11 times for setting the arithmetical sign.
⌚⌚⌚⌚ -0500	Value -500 will be displayed. Confirm by pressing the  key to start positioning.

4.3 Menu selection

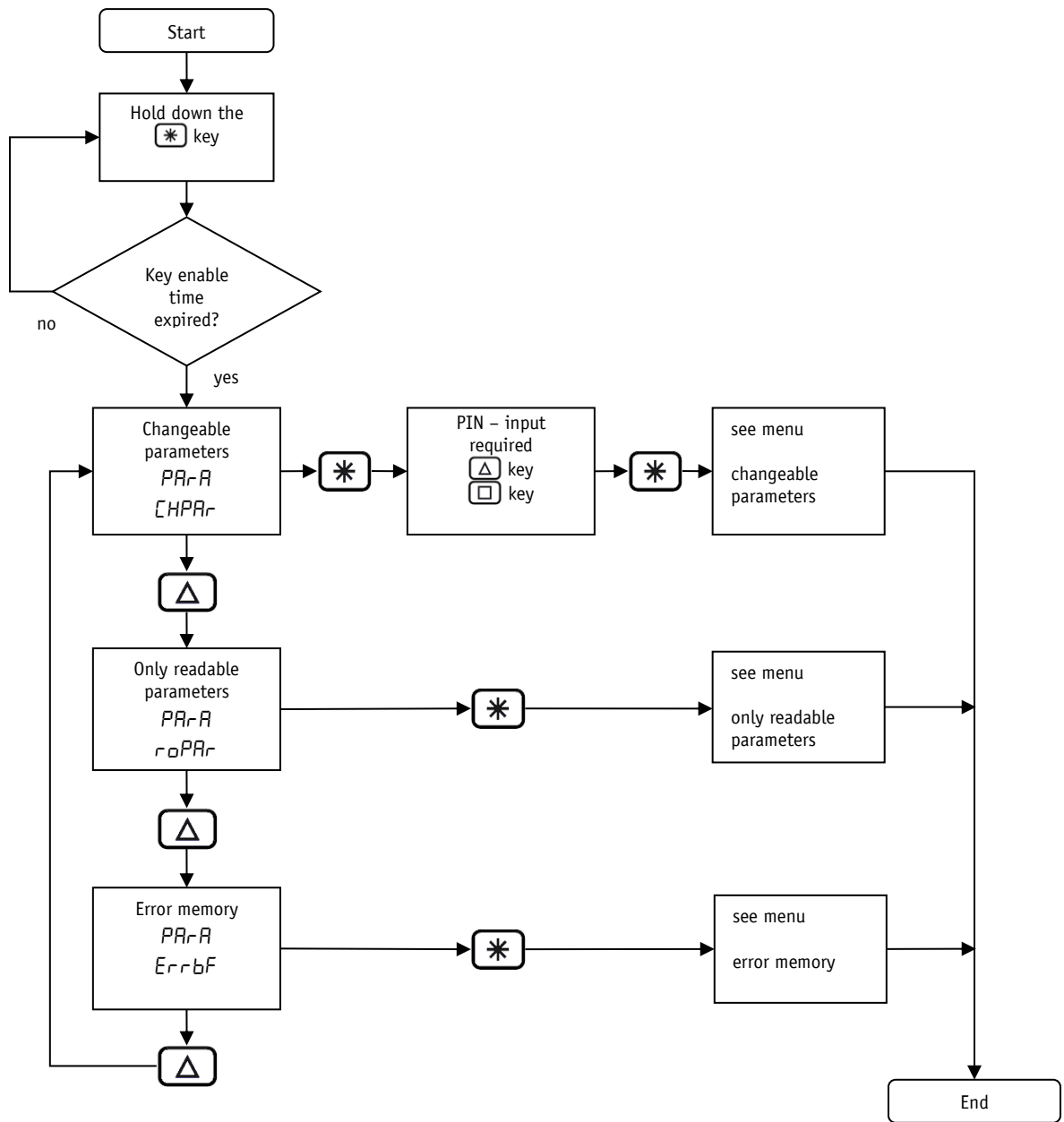

Fig. 6: Menu selection

4.3.1 Changeable parameters

The Changeable parameters menu is subdivided into further sub-menus:

Menu	Sub-menu	Description
PARA [HPAR	PARA BUS	Bus parameters
	PARA POSIT	Positioning
	PARA DRU	Actuator
	PARA BOUND	Limiting values
	PARA VISID	Visualization
	PARA OPTID	Options
	PARA CONTR	Controller parameter
	PARA QUIT	Exit menu

Table 2: Changeable parameters menu overview

4.3.1.1 Bus parameters

Menu	PARA [HPAR	Sub-menu	PARA BUS

Parameter	Description
Id	Node address Value range: 0 - 31 (see chapter 8: Parameter description ⇒ Parameter no. 22)
BAUD	Baud rate Selection: 575: 57600 baud 1152: 115200 baud 192: 19200 baud (see chapter 8: Parameter description ⇒ Parameter no. 33)
PRTEL	Protocol Selection: 505: SIKONETZ5 SERUC: Service protocol (see chapter 8: Parameter description ⇒ Parameter no. 34)

Parameter	Description
<code>bUS t o</code>	Bus Timeout Value range: 0 – 20 (see chapter 8: Parameter description ⇒ Parameter no. 35)

Table 3: Bus parameter menu

4.3.1.2 Positioning

Menu	<code>PARA</code> <code>CHPAR</code>	Sub-menu	<code>PARA</code> <code>POS It</code>
------	---	----------	--

Parameter	Description
<code>EA r g t</code>	Pos window Value range: 0 - 1000 (see chapter 8: Parameter description ⇒ Parameter no. 10)
<code>P I t C H</code>	Spindle pitch Value range: 0 - 99999 (see chapter 8: Parameter description ⇒ Parameter no. 13)
<code>d I U</code>	Display divisor Selection: <code>I</code> : 1 <code>I0</code> : 10 <code>I00</code> : 100 <code>I000</code> : 1000 (see chapter 8: Parameter description ⇒ Parameter no. 43)
<code>EA L I b</code>	Calibration value Value range: -19999 ... 99999 (see chapter 8: Parameter description ⇒ Parameter no. 14)
<code>LO A d P</code>	Selection: <code>n o</code> : no calibration <code>EA L I b</code> : Execute calibration
<code>O F F S e t</code>	Offset Value range: -19999 ... 99999 (see chapter 8: Parameter description ⇒ Parameter no. 32)
<code>r o t A t e</code>	Sense of rotation Selection: <code>EA r</code> : i sense of rotation (cw) <code>EA EA r</code> : e sense of rotation (ccw) (see chapter 8: Parameter description ⇒ Parameter no. 18)

Parameter	Description
<i>POtYP</i>	Pos Type Selection: <i>dIr</i> : direct <i>POS</i> : loop+ <i>nES</i> : loop- (see chapter 8: Parameter description ⇒ Parameter no. 19)
<i>LOOP</i>	Loop length Value range: 0 – 30000 (see chapter 8: Parameter description ⇒ Parameter no. 27)

Table 4: Positioning menu

4.3.1.3 Actuator

Menu	<i>PARA</i> <i>CHPAR</i>	Sub-menu	<i>PARA</i> <i>dru</i>
------	-----------------------------	----------	---------------------------

Parameter	Description
<i>A POS</i>	Acceleration in the positioning mode Value range: 1 – 100 (see chapter 8: Parameter description ⇒ Parameter no. 4)
<i>U POS</i>	Maximum speed in the positioning mode Gear 66:1 ⇒ value range: 1 - 75 Gear 98:1 ⇒ value range: 1 - 50 (see chapter 8: Parameter description ⇒ Parameter no. 5)
<i>A rot</i>	Acceleration in rotational speed mode Value range: 1 - 100 (see chapter 8: Parameter description ⇒ Parameter no. 6)
<i>A InC</i>	Acceleration in inching mode 1/2 Value range: 1 - 100 (see chapter 8: Parameter description ⇒ Parameter no. 8)
<i>U InC</i>	Maximum speed in inching mode 1/2 Gear 66:1 ⇒ value range: 1 - 75 Gear 98:1 ⇒ value range: 1 - 50 (see chapter 8: Parameter description ⇒ Parameter no. 9)
<i>gtrnu</i>	Numerator gear ratio Value range: 1 - 10000 (see chapter 8: Parameter description ⇒ Parameter no. 11)
<i>gtrdE</i>	Denominator gear ratio Value range: 1 - 10000 (see chapter 8: Parameter description ⇒ Parameter no. 12)

Table 5: Actuator menu

4.3.1.4 Limiting values

Menu	PARA [HPAR	Sub-menu	PARA bound
------	---------------	----------	---------------

Parameter	Description
EndP1	Limit 1 Value range: -19999 ... 99999 (see chapter 8: Parameter description ⇒ Parameter no. 15)
EndP2	Limit 2 Value range: -19999 ... 99999 (see chapter 8: Parameter description ⇒ Parameter no. 16)
torqE	Current limiting Value range: 25 - 110 (see chapter 8: Parameter description ⇒ Parameter no. 29)
Cont	Contouring error limit Value range: 1 - 30000 (see chapter 8: Parameter description ⇒ Parameter no. 28)

Table 6: Limiting values menu

4.3.1.5 Visualization

Menu	PARA [HPAR	Sub-menu	PARA U1510
------	---------------	----------	---------------

Parameter	Description
d15PL	Display orientation Selection: 0: 0° 180: 180° (see chapter 8: Parameter description ⇒ Parameter no. 45)
ORA2	LED 2 orange function Selection: on: Bus operation display OFF: Off (see chapter 8: Parameter description ⇒ Parameter no. 39)
red1	Red LED 1 function Selection: on: Indication of the operating status OFF: Off (see chapter 8: Parameter description ⇒ Parameter no. 40)

Parameter	Description
Grn 1	Green LED 1 function Selection: on: Indication of the operating status OFF: Off (see chapter 8: Parameter description ⇒ Parameter no. 41)
dEC 1	Decimal places Selection: 0: 0 0 1: 0.0 002: 0.00 0003: 0.000 00004: 0.0000 (see chapter 8: Parameter description ⇒ Parameter no. 42)
Ind IC	Direction indication function Selection: on: On InUrs: inverted OFF: Off (see chapter 8: Parameter description ⇒ Parameter no. 44)
L InE2	Displayed value of 2 nd display line Selection: tArSt: Set point dE9: Output stage temperature CUoLk: Control voltage PUoLk: Output stage voltage UbaLk: Battery voltage I dru: Motor current POS: Actual position VELD: Actual rotational speed (see chapter 8: Parameter description ⇒ Parameter no. 49)
tESt	Display test Selection: no: no display test YES: Start display test, pressing the  key stops display test.

Table 7: Visualization menu

4.3.1.6 Options

Menu	PARA [HPAR	Sub-menu	PARA OPT 10
------	---------------	----------	----------------

Parameter	Description
<i>cdELA</i>	Key enable time Value range: 1 - 60 (see chapter 8: Parameter description ⇒ Parameter no. 37)
<i>bWtEn</i>	Key function enable Selection: <i>on</i> : Enable all key functions <i>OFF</i> : All key functions disabled (see chapter 8: Parameter description ⇒ Parameter no. 38)
<i>OPtYP</i>	Operating mode Selection: <i>POS</i> : Positioning mode <i>VELD</i> : Rotational speed mode (see chapter 8: Parameter description ⇒ Parameter no. 20)
<i>d InCH</i>	Delta Inch Value range: -19999 ... 99999 (see chapter 8: Parameter description ⇒ Parameter no. 17)
<i>InPOS</i>	Inpos mode Selection: <i>EntRL</i> : Position control to set point <i>SHorT</i> : Position control Off and short circuit of all motor windings <i>FrEE</i> : Position control Off and drive enable (see chapter 8: Parameter description ⇒ Parameter no. 26)
<i>A tYP</i>	Inching mode 2 acceleration type Selection: <i>StAt</i> : static acceleration <i>dYn</i> : incremental acceleration (see chapter 8: Parameter description ⇒ Parameter no. 31)
<i>StoP2</i>	Stop mode inching 2 Selection: <i>Har-d</i> : stop with maximum deceleration <i>SOFE</i> : stop with programmed deceleration (see chapter 8: Parameter description ⇒ Parameter no. 25)
<i>0 InC2</i>	Inching 2 Offset Value range: 10 - 100 (see chapter 8: Parameter description ⇒ Parameter no. 30)
<i>P In</i>	PIN change Value range: 0 - 99999 (see chapter 8: Parameter description ⇒ Parameter no. 48)

Parameter	Description
<i>LOADP</i>	S commands Selection: <i>no</i> : execute no S command <i>ALL</i> : Set all parameters to default <i>StAnd</i> : Set standard parameters to default <i>dr lUE</i> : Set controller parameters to default <i>d ISPL</i> : Set display parameters to default <i>bUS</i> : Set bus parameters to default <i>CAL Ib</i> : Calibration <i>dLErr</i> : Delete error memory

Table 8: Options menu

4.3.1.7 Controller parameters

Menu	<i>PARA</i> <i>CHPAR</i>	Sub-menu	<i>PARA</i> <i>Contr</i>
------	-----------------------------	----------	-----------------------------

Parameter	Description
<i>CPAR P</i>	Controller parameter P Value range: 1 - 500 (see chapter 8: Parameter description ⇒ Parameter no. 1)
<i>CPAR I</i>	Controller parameter I Value range: 0 - 500 (see chapter 8: Parameter description ⇒ Parameter no. 2)
<i>CPAR d</i>	Controller parameter D Value range: 0 - 500 (see chapter 8: Parameter description ⇒ Parameter no. 3)

Table 9: Controller parameters menu

4.3.2 Readable parameters

Menu	<i>PARA</i> <i>roPAR</i>
------	-----------------------------

Parameter	Description
<i>dEG</i>	Current output stage temperature
<i>CUoLt</i>	Current control voltage
<i>PUoLt</i>	Current output stage voltage
<i>UbaLt</i>	Current battery voltage

Parameter	Description
<i>i dru</i>	Current motor current
<i>POS</i>	Current actual position
<i>VELD</i>	Current actual speed
<i>rEdUC</i>	Gear reduction
<i>P dru</i>	Motor rated power
<i>EnCrE</i>	Encoder resolution
<i>U LLD</i>	Display controller software version
<i>U dru</i>	Motor controller software version
<i>SErno</i>	Serial number
<i>dPProd</i>	Production date

Table 10: Readable parameters menu

4.3.3 Error memory

Menu	<i>PARA</i> <i>ErrbF</i>
------	-----------------------------

Parameter	Description
<i>Errno</i> 0	Number of errors in the error memory (see chapter 8: Parameter description ⇒ Parameter no. 61)
<i>Err 1</i> xxxxx	Error 1 (see chapter 8: Parameter description ⇒ Parameter no. 62)
<i>Err 2</i> xxxxx	Error 2 (see chapter 8: Parameter description ⇒ Parameter no. 63)
<i>Err 3</i> xxxxx	Error 3 (see chapter 8: Parameter description ⇒ Parameter no. 64)
<i>Err 4</i> xxxxx	Error 4 (see chapter 8: Parameter description ⇒ Parameter no. 65)
<i>Err 5</i> xxxxx	Error 5 (see chapter 8: Parameter description ⇒ Parameter no. 66)
<i>Err 6</i> xxxxx	Error 6 (see chapter 8: Parameter description ⇒ Parameter no. 67)
<i>Err 7</i> xxxxx	Error 7 (see chapter 8: Parameter description ⇒ Parameter no. 68)
<i>Err 8</i> xxxxx	Error 8 (see chapter 8: Parameter description ⇒ Parameter no. 69)
<i>Err 9</i> xxxxx	Error 9 (see chapter 8: Parameter description ⇒ Parameter no. 70)

Parameter	Description
Err 10 xxxxx	Error 10 (see chapter 8: Parameter description ⇒ Parameter no. 71)

Table 11: Error memory menu

xxxxx = Plain text display of error codes (see chapter 7.2.1: [Error codes](#))

5 Calibration

Two steps are required for executing calibration:

1. Write the calibration value
2. Execute calibration

Since the measuring system is an absolute system, calibration is necessary only once with commissioning. With calibration, the calibration value is adopted for calculation of the position value. The following equation is applied in case of calibration:

Position value = 0 + calibration value + offset value

Calibration value (see chapter 8: [Parameter description](#) ⇒ [Parameter no.14](#))

Offset value (see chapter 8: [Parameter description](#) ⇒ [Parameter no. 32](#))

NOTICE

Calibration is only possible when no travel job is active!

6 External gear

If an external gear is used, a factor can be programmed via the parameters no. 11 'ü – numerator' and parameter no. 12 'ü – denominator' in order to include the gear ratio in position sensing.

Example (see [Fig. 7](#)):

The actuator is operated on a gear with transmission reduction of 5:1. For this purpose, the parameters 'ü-numerator' and 'ü-denominator' must be programmed as follows:

- Parameter 'ü – numerator': 5
- Parameter 'ü – denominator': 1

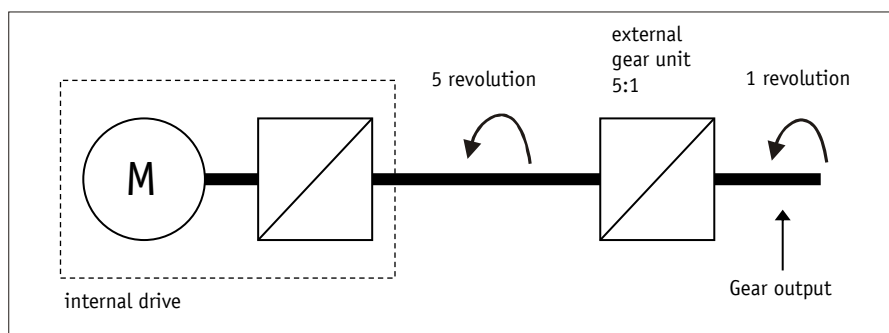

Fig. 7: External gear

Input of an odd gear transmission reduction value is possible according to the following example:

Transmission reduction = 3.78

- Parameter 'ü – numerator': 378
- Parameter 'ü – denominator': 100

7 Warnings / Errors

7.1 Warnings

Warnings do not influence the operation of the positioning drive. Warnings disappear after removing the cause.

Possible warnings:

- Battery voltage for absolute encoder is below limit \Rightarrow exchange battery within the next 6 months.
- Current limiting active.

7.2 Errors

Errors cause an immediate stop of the positioning drive. Error states are signalled via display.

Via interface errors can also be detected:

- The error messages are entered in the error memory in the order of their detection. The last 10 error messages are displayed when the error memory is full.
- The cause of error can be tracked down with the help of the error codes.

7.2.1 Error codes

Display	Error codes	Error
<i>noErr</i>	0x00	No error
<i>toCLI</i>	0x01	Timeout client
<i>toHDS</i>	0x02	Timeout host
<i>c5CLI</i>	0x03	Check sum client
<i>c5HDS</i>	0x04	Check sum host
<i>defIn</i>	0x05	Define mismatch
<i>bAtt</i>	0x06	Low battery voltage
<i>CUuLt</i>	0x07	Low control electronics voltage
<i>CoUuLt</i>	0x08	Excess control electronics voltage
<i>POuUuLt</i>	0x09	Excess power electronics voltage
<i>ouErT</i>	0x0A	Output stage excess temperature

Display	Error codes	Error
L A 9	0x0B	Contouring error
b L o c	0x0C	Shaft blocked
n o S U P	0x0D	Power electronics: not supplied
b t Y P E	0x0E	Unknown bus type
S i n C O	0x0F	SIN COS monitoring error
q 1 o v e r	0x10	Queue 1 overrun
q 2 o v e r	0x11	Queue 2 overrun
q U E S t	0x12	Response doesn't match question
C S E E P	0x13	Check sum EEPROM
C S b u s	0x80	Check sum SIKONETZ5
t o b u s	0x81	Timeout SIKONETZ5

Table 12: Error codes

7.3 Input errors

Input errors inform the user about errors that occurred during menu entries. Entries that produce errors are not adopted. Input errors are not saved in the error memory.

Display	Description
U A L U E	Value range exceeded / inappropriate
L I U P	Input value exceeds upper limit
L I L O	Input value exceeds lower limit
A C C E S	Access not supported
P r 2 r o	Write on read only
r d 2 P O	Read on write only
S t A t E	Error caused by device status
b u s y	Input disabled due to ongoing EEPROM write access
d J A c t	Input disabled due to active travelling job
n o P r g	Programming lock activated

8 Parameter description

Column	Explanation
S	"S" = Parameter transferred is saved in the device non-volatilely "- " = Parameter transferred is saved in the device volatilely
C	Parameter class 1 = Standard parameter 2 = Controller parameter 3 = Display parameter 4 = Bus parameter 5 = general parameter

No.	Name	Selection / value	Default	Description	S	C
1	Controller parameter P	1 - 500	300	P gain of controller: valid for all operating modes (positioning mode, speed mode, inching mode)	S	2
2	Controller parameter I	0 - 500	2	I gain of controller: valid for all operating modes (positioning mode, speed mode, inching mode)	S	2
3	Controller parameter D	0 - 500	0	D gain of controller: valid for all operating modes (positioning mode, speed mode, inching mode)	S	2
4	a - pos	1 - 100	50	Acceleration in the positioning mode: values in % 100 % correspond to: Gear 66:1 \Rightarrow 3.04 rps ² Gear 98:1 \Rightarrow 2.05 rps ²	S	2
5	v - pos	see Description column	10	Maximum speed in the positioning mode: values in rpm Gear 66:1 \Rightarrow 1 - 75 rpm Gear 98:1 \Rightarrow 1 - 50 rpm	S	2
6	a - rot	1 - 100	50	Acceleration in rotational speed mode: values in % 100 % correspond to: Gear 66:1 \Rightarrow 3.04 rps ² Gear 98:1 \Rightarrow 2.05 rps ²	S	2
7				reserved		
8	a - inch	1 - 100	50	Acceleration in inching mode 1/2: values in % 100 % correspond to: Gear 66:1 \Rightarrow 3.04 rps ² Gear 98:1 \Rightarrow 2.05 rps ²	S	2
9	v - inch	see Description column	10	Maximum speed in inching mode 1/2: values in rpm Gear66:1 \Rightarrow 1 - 75 rpm Gear98:1 \Rightarrow 1 - 50 rpm	S	2

No.	Name	Selection / value	Default	Description	S	C
10	Pos window	0 - 1000	10	<p>Operating mode: Positioning mode: Positioning window If the actual position of the actuator is within the programmed set point \pm this window, this is signalled by setting bit 3 in the status word of the actuator. Spindle pitch = 0: Values refer to increments Spindle pitch > 0: Values refer to travel distance in 1/100 mm</p> <p>Operating mode: Speed mode: If the actual rotational speed is within the target rotational speed \pm this window, this is signalled by setting bit 3 in the system status word of the actuator.</p>	S	1
11	ü - numerator	1 - 10000	1	<p>Numerator gear ratio: a gear factor can be programmed here when a gear is used.</p>	S	1
12	ü - denominator	1 - 10000	1	<p>Denominator gear ratio: a gear factor can be programmed here when a gear is used.</p>	S	1
13	Spindle pitch	0 - 1000000	0	<p>Spindle pitch: Spindle pitch parameter = 0: Position value is output in increments (720 increments per revolution of the driving shaft). Spindle pitch parameter > 0: (when operating the actuator on a spindle) The position value is output as travelling distance in 1/100 mm, not in increments. Input of target position is now in 1/100 mm as well. e. g. spindle with a pitch of 2 mm \Rightarrow Spindle pitch parameter = 200.</p>	S	1
14	Calibration value	-999999 to 999999	0	<p>Calibration value: Changes to the calibration value are adopted for calculation of the position value via S command only after calibration. Position value = 0 + calibration value + offset value</p>	S	1

No.	Name	Selection / value	Default	Description	S	C
15	Limit 1	-9999999 to 9999999	99999	<p>Operating mode: Positioning mode: Limit 1</p> <p>Spindle pitch = 0: Values refer to increments Spindle pitch > 0: Values refer to travelling distance in 1/100 mm</p> <p>If actuator's position is beyond the range defined by limit 1 and limit 2 (travel range), travelling will only be possible in inching mode in the direction of the travel range.</p> <p>Notice! Limit monitoring is deactivated if 'limit 1' is equal 'limit 2'. Please note that there is a jump of the actual position if the resolution of the absolute encoder is exceeded!</p> <p>Operating mode: Speed mode: irrelevant</p>	S	1
16	Limit 2	-9999999 to 9999999	-19999	<p>Operating mode: Positioning mode: Limit 2</p> <p>Spindle pitch = 0: Values refer to increments Spindle pitch > 0: Information refers to travel distance in 1/100 mm</p> <p>If actuator's position is beyond the range defined by limit 1 and limit 2 (travel range), travelling will only be possible in inching mode in the direction of the travel range.</p> <p>Notice! Limit monitoring is deactivated if 'limit 1' is equal 'limit 2'. Please note that there is a jump of the actual position if the resolution of the absolute encoder is exceeded!</p> <p>Operating mode: Speed mode: irrelevant</p>	S	1
17	Delta inch	-1000000 to 1000000	720	<p>Delta travelling distance with inching operation 1:</p> <p>Indicates the relative travelling distance. positive value ⇒ positive travelling direction negative value ⇒ negative travelling direction</p> <p>Spindle pitch = 0: Values refer to increments Spindle pitch > 0: Information refers to travel distance in 1/100 mm</p>	S	1

No.	Name	Selection / value	Default	Description	S	C
18	Sense of rotation	i, e	i	Counting direction of the measuring system: With shaft rotating counter-clockwise (view on the clamping ring of the actuator) i sense of rotation (cw): ⇒ positive counting direction e sense of rotation (ccw): ⇒ negative counting direction	S	1
19	Pos Type	direct loop + loop -	direct	Operating mode: Positioning mode: Type of positioning direct: direct travelling from actual position to set point loop +: travelling to the set point occurs always in positive direction to compensate for spindle play loop -: travelling to the set point occurs always in negative direction to compensate for spindle play Notice! Loop positioning in positioning mode only. Operating mode: Speed mode: irrelevant	S	1
20	Operating mode	positioning mode / speed mode	positioning mode	Operating mode: Positioning mode: (see chapter 4.1.3.1: Positioning mode) Operating mode: Speed mode: (see chapter 4.1.3.3: Rotational speed mode)	S	1
21				reserved		
22	Node address	0 - 31	1	SIKONETZ5: Setting the SIKONETZ5 node address Parameter changes become active only after cold start or software reset. Service protocol: no function	S	5
23				reserved		
24	Set point	see Description column	0	Operating mode: Positioning mode: Indicates absolute target position. Spindle pitch = 0: Values refer to increments Spindle pitch > 0: Information refers to travel distance in 1/100 mm Value range: depends on the preprogrammed target values (parameters 15/16) Operating mode: Speed mode: indicates the target rotational speed in rpm Value range: Gear 66:1 ⇒ max. ±75 rpm Gear 98:1 ⇒ max. ±50 rpm	-	1

No.	Name	Selection / value	Default	Description	S	C
25	Stop mode Inch 2	0 - 1	0	Stop mode inching mode 2 / inching key operation Stopping behaviour of inching mode 2 or inching key mode, resp., can be parameterized differently. Stop mode = 0 stop with maximum deceleration Stop mode = 1 stop with programmed deceleration (Parameter no. 8)	S	1
26	Inpos mode	0 - 2	0	Operating mode: Positioning mode: With this parameter you can define the behaviour of the actuator upon reaching the position window: Inpos mode = 0 Position control to set point Inpos mode = 1 Position control OFF and short circuit of the motor windings Inpos mode = 2 Position control OFF and drive enable Operating mode: Speed mode: irrelevant	S	1
27	Loop length	0 - 30000	360	Operating mode: Positioning mode: Spindle pitch = 0: Values refer to increments Spindle pitch > 0: values refer to travel distance in 1/100 mm Operating mode: Speed mode: irrelevant	S	1
28	Contouring error limit	1 - 30000	400	Contouring error limit: Exceeding the contouring error limit during ongoing positioning results in a "Contouring error" fault.	S	1
29	Current limiting	25 - 110	110	Current limiting: Limiting of surge current. Figures indicate percentage of nominal current	S	1
30	Inching 2 Offset	10 - 100	100	Inching operation 2: The inching speed in Inching operation 2 can be influenced via this parameter Values in percentage of parameter no. 9.	-	1

No.	Name	Selection / value	Default	Description	S	C
31	Type of acceleration Inching mode 2	0 - 1	0	Inching operation 2: The type of acceleration can be set with this parameter. 0 = static acceleration Acceleration to final speed in one step as defined under parameter no. 8. 1 = incremental acceleration Acceleration to final speed as defined under parameter no. 8 with the following increments: 4 s to 20 % of final speed 2 s to 50 % of final speed 1 s to 100 % of final speed	S	1
32	Offset	-999999 to 999999	0	Offset value Changes to the offset value are immediately entered in the calculation of the position value. The following equation is applied in case of calibration: Position value = 0 + calibration value + offset value	S	1
33	Baud rate RS485	0 - 2	1	Baud rate of the RS485 interface: 0 = 19200 1 = 57600 2 = 115200 Parameter changes become active only after cold start or software reset.	S	5
34	Protocol	0 - 1	0	Protocol of the RS485 interface: 0 = SIKONETZ5 1 = Service protocol Parameter changes become active only after cold start or software reset.	S	5
35	Bus Timeout	0 - 20	20	SIKONETZ5: Notice! Unplanned device reactions. Unplanned device reactions can occur with time monitoring disabled ("0"= disabled) and simultaneous cable break. In the delivery state, time monitoring is enabled. Mode: Time monitoring "disabled=0" is only admissible for test purposes. Enable time monitoring after leaving the test mode. 1-20 = Bus Timeout values in x100 ms Service protocol: no function	S	4

No.	Name	Selection / value	Default	Description	S	C
36	Write reply parameter to set point	0 - 8	1	SIKONETZ5: This parameter defines the reply to the Write set point command 0 = Set point 1 = Actual value 2 = Output stage temperature 3 = Control voltage 4 = Output stage voltage 5 = Battery voltage 6 = Motor current 7 = Actual position 8 = Actual rotational speed Service protocol: no function	S	4
37	Key enable time	1 - 60	3	Display / key control: Time in seconds the asterisk key must be held down until menu can be entered or the set point specification is enabled via display.	S	3
38	Key function enable	0 - 1	0	Display / key control: The access to inching mode 2, positioning mode and rotational speed mode functions via keys can be set with this parameter. 0 = all functions via key enabled 1 = all functions via key disabled	S	3
39	LED 2 orange	0 - 1	1	LED 2 orange function: 0 = Off 1 = Bus operation indication	S	3
40	LED 1 red	0 - 1	1	Red LED 1 function: 0 = Off 1 = Indication of the operating status	S	3
41	LED 1 green	0 - 1	1	Green LED 1 function: 0 = Off 1 = Indication of the operating status	S	3
42	Decimal places	0 - 4	0	Display: Input of decimal places 0 = 0 1 = 0.0 2 = 0.00 3 = 0.000 4 = 0.0000	S	3
43	Display divisor	0 - 3	0	Display: Divisor by which the display accuracy is reduced compared with the measurement resolution. 0 = 1 1 = 10 2 = 100 3 = 1000	S	3

No.	Name	Selection / value	Default	Description	S	C
44	Direction indication function	0 - 2	0	Display: The direction indicators show the key to be pressed to arrive at the set position window. 0 = On 1 = Inverted 2 = Off	S	3
45	Display orientation	0 - 1	0	Display: Display orientation 0 = 0° 1 = rotated by 180°	S	3
46	Programming mode configuration	0 - 1	0	SIKONETZ5: 0 = no programming mode 1 = apply programming mode Service protocol: no function	S	5
47	Programming mode	0 - 1	0	SIKONETZ5: 0 = Programming mode Off 1 = Programming mode On Service protocol: no function	-	1
48	PIN Change	0 - 99999	0	Display: Required PIN to be able to change parameters via keys and display.	S	3
49	Displayed value 2 nd display line	0 - 7	0	Display: Parameter to be displayed in the 2 nd line of the display. 0 = Set point 1 = Output stage temperature 2 = Control voltage 3 = Output stage voltage 4 = Battery voltage 5 = Motor current 6 = Actual position 7 = Actual rotational speed	S	3
50	Output stage temperature	Read only	-	Output stage temperature: Values in 1/10 °C	-	-
51	Voltage of control	Read only	-	Control voltage: Values in 1/10 V	-	-
52	Voltage of output stage	Read only	-	Output stage voltage: Values in 1/10 V	-	-
53	Voltage of battery	Read only	-	Battery voltage: Values in 1/100 V	-	-
54	Motor current	Read only	-	Motor current: Values in mA	-	-

No.	Name	Selection / value	Default	Description	S	C
55	Actual position	Read only	-	Actual position: Spindle pitch = 0: values in increments Spindle pitch > 0: values in 1/100 mm	-	-
56	Actual rotational speed	Read only	-	Actual rotational speed: Values in rpm	-	-
57	Serial number	Read only	-	Serial number	S	-
58	Production date	Read only	-	Production date: Format: DDMMJJJJ	S	-
59	Software version motor controller	Read only	-	Motor controller software version	S	-
60	Software version display controller	Read only	-	Display controller software version	S	-
61	Number of errors	Read only	-	Number of errors in the error memory	S	-
62	Error 1	Read only	-	Error 1	S	-
63	Error 2	Read only	-	Error 2	S	-
64	Error 3	Read only	-	Error 3	S	-
65	Error 4	Read only	-	Error 4	S	-
66	Error 5	Read only	-	Error 5	S	-
67	Error 6	Read only	-	Error 6	S	-
68	Error 7	Read only	-	Error 7	S	-
69	Error 8	Read only	-	Error 8	S	-
70	Error 9	Read only	-	Error 9	S	-
71	Error 10	Read only	-	Error 10	S	-
72	Gear reduction	Read only	-	Gear reduction	S	-
73	System Status Word	Read only	-	System status word	-	-
74	Display divisor application	0 - 1	0	Positioning mode only: 0 = The display divisor will be applied to the interface's target and actual positions and to the display. 1 = The display divisor will be applied to the display only.	S	3

Table 13: Parameter description

9 Service Protocol

9.1 General

The service protocol enables drive configuration and control via ASCII commands. No additional devices must be connected to the RS485 interface since this protocol is not bus-compatible.

This user manual is valid with Motor controller firmware version V1.11!

The PC sends a letter and additional parameters if required (ASCII).

Subsequently, the AG05 sends a reply with a concluding <CR>.

Parameters: 19200 / 57600 / 115200 baud, no parity, 8 data bits, 1 stop bit, no handshake

9.2 System Status Word

The system status word consists of 2 bytes and reflects the state of the actuator (see chapter 8: [Parameter description](#) ⇒ [Parameter no. 73](#)).

High Byte								Low Byte							
Bit Nummer															
15	14	13	12	11	10	9	8	7	6	5	4	3	2	1	0
0	0	1	0	1	0	0	1	0	1	0	0	1	0	0	0
2				9				4				8			

Table 14: Structure of system status word

Example (grey background):

binary: ⇒ 0010 1001 0100 1000

hex: ⇒ 2 9 4 8

9.2.1 Meaning of the bits

The table below informs about the meaning of the individual bits of the status word:

Bit	State	Description
Bit 0	'0'	irrelevant
Bit 1	'0'	irrelevant
Bit 2	'0'	irrelevant
Bit 3		Operating mode: Positioning mode In Position
	'1'	Actual position is within the positioning window of the programmed set point.
	'0'	Actual position is beyond the positioning window of the programmed set point.
		Operating mode: Speed mode: In Position
	'1'	Actual rotational speed is within the specified tolerance window of the target speed.

Bit	State	Description
	'0'	Actual speed is outside the specified tolerance window.
Bit 4		Actuator travels:
	'1'	Actuator travels.
	'0'	Drive stands still (rotational speed <2 rpm).
Bit 5		Operating mode: Positioning mode, upper limit
	'1'	Actual position is above the programmed limiting value. Travelling is possible only in negative direction in inching mode.
	'0'	Actual position is below the programmed limiting value.
	'0'	Operating mode: Speed mode: irrelevant
Bit 6		Operating mode: Positioning mode, lower limit
	'1'	Actual position is below the programmed limiting value. Travelling is possible only in positive direction in inching mode.
	'0'	Actual position is above the programmed limiting value.
	'0'	Operating mode: Speed mode: irrelevant
Bit 7		Driver state:
	'1'	Motor is enabled.
	'0'	Motor in control.
Bit 8		Error:
	'1'	Actuator has switched to error. The cause of the error must be removed and acknowledged.
	'0'	No error present.
Bit 9		Operating mode: Positioning mode: Loop travel
	'1'	If travel direction unequal start direction (with loop travel).
	'0'	If travel direction equal start direction.
	'0'	Operating mode: Speed mode: irrelevant
Bit 10		Output stage supply voltage:
	'1'	No voltage, no travelling possible.
	'0'	Voltage applied.
Bit 11		Ready for travel:
	'1'	Not ready for travel
	'0'	Ready for travel: - Actuator not in error state - No active positioning - Supply voltage of the output stage is applied - Actual position within limits (only positioning mode)
Bit 12		Battery voltage:
	'1'	Battery voltage <2.6 V
	'0'	Battery voltage OK
Bit 13		Current limiting:
	'1'	Current limiting active.
	'0'	Current limiting not active.

Bit	State	Description
Bit 14		Operating mode: Positioning mode Status
	'1'	Positioning active in positioning mode.
	'0'	Positioning inactive.
		Operating mode: Speed mode: Status
	'1'	Enable target speed.
	'0'	Target speed disabled.
Bit 15		Contouring error:
	'1'	Contouring error ⇒ the actuator cannot reach the pre-set speed due to too high load. The actuator switches the contouring error fault. Remedy: reduce programmed speed!
	'0'	No contouring error ⇒ actual speed corresponds to target speed

Table 15: System Status Word

9.3 Service protocol commands list

Command	Length	Reply	Description
Ay	2/10	"xxxxxxxx>"	Device type / software version
			y = 0: hardware version
			y = 1: Motor controller software version (see chapter 8: Parameter description ⇒ Parameter no. 59)
			y = 2: Display controller software version (see chapter 8: Parameter description ⇒ Parameter no. 60)
			y = 3: Bus version
			y = 4: Gear reduction (see chapter 8: Parameter description ⇒ Parameter no. 72)
			y = 5: Serial number (see chapter 8: Parameter description ⇒ Parameter no. 57)
Byy	3/10 dec	"±xxxxxxxx>"	Diagnosis
			yy = 0: Output stage temperature [1/10 °C] (see chapter 8: Parameter description ⇒ Parameter no. 50)
			yy = 1: Control unit voltage [1/10 V] (see chapter 8: Parameter description ⇒ Parameter no. 51)
			yy = 2: Output stage voltage [1/10 V] (see chapter 8: Parameter description ⇒ Parameter no. 52)
			yy = 3: Battery voltage [1/100 V] (see chapter 8: Parameter description ⇒ Parameter no. 53)
			yy = 4: Motor current [mA] (see chapter 8: Parameter description ⇒ Parameter no. 54)

Command	Length	Reply	Description
Ey	2/10	"±xxxxxxx>"	Output values with spindle pitch = 0: ±xxxxxxx = decimal value in increments with spindle pitch > 0 ±xxxxxxx = decimal value 1/100 mm
			y = 0: Current set point (see chapter 8: Parameter description ⇒ Parameter no. 24)
			y = 1: Limit 1 (see chapter 8: Parameter description ⇒ Parameter no. 15)
			y = 2: Limit 2 (see chapter 8: Parameter description ⇒ Parameter no. 16)
			y = 3: Calibration value (see chapter 8: Parameter description ⇒ Parameter no. 14)
			y = 4: Delta travelling distance with inching operation 1 (see chapter 8: Parameter description ⇒ Parameter no. 17)
			y = 5: Offset (siehe Kapitel 8: Parameter description ⇒ Parameter no. 32)
Fy±xxxxxxx	10/2	">"	Enter values with spindle pitch = 0: ±xxxxxxx decimal value in increments with spindle pitch > 0 ±xxxxxxx decimal value 1/100 mm
			y = 0: Positioning mode: target position (volatile) with spindle pitch = 0 Values refer to increments with spindle pitch > 0 Values refer to travel distance in 1/100 mm Speed mode: target speed (volatile)
			y = 1: Limit 1 (see chapter 8: Parameter description ⇒ Parameter no. 15)
			y = 2: Limit 2 (see chapter 8: Parameter description ⇒ Parameter no. 16)
			y = 3: Calibration value (see chapter 8: Parameter description ⇒ Parameter Nr. 14)
			y = 4: Delta travelling distance with inching operation 1 (see chapter 8: Parameter description ⇒ Parameter no. 17)
			y = 5: Offset (see chapter 8: Parameter description ⇒ Parameter no. 32)
Gyy	3/7	"xxxxx>"	Output 2-byte value yy = address xxxxx = decimal value
			yy = 00: Controller parameter P (see chapter 8: Parameter description ⇒ Parameter no. 1)
			yy = 01: Controller parameter I (see chapter 8: Parameter description ⇒ Parameter no. 2)

Command	Length	Reply	Description
			yy = 02: Controller parameter D (see chapter 8: Parameter description ⇒ Parameter no. 3)
			yy = 03: a-Pos (see chapter 8: Parameter description ⇒ Parameter no. 4)
			yy = 04: v-Pos (see chapter 8: Parameter description ⇒ Parameter no. 5)
			yy = 05: a-rot (see chapter 8: Parameter description ⇒ Parameter no. 6)
			yy = 06: reserved
			yy = 07: a-inch (see chapter 8: Parameter description ⇒ Parameter no. 8)
			yy = 08: v-inch (see chapter 8: Parameter description ⇒ Parameter no. 9)
			yy = 09: Pos window Spindle pitch = 0 -> increments Spindle pitch > 0 -> 1/100 mm (see chapter 8: Parameter description ⇒ Parameter no. 10)
			yy = 10: ü-numerator (see chapter 8: Parameter description ⇒ Parameter no. 11)
			yy = 11: ü-denominator (see chapter 8: Parameter description ⇒ Parameter no. 12)
			yy = 12: reserved
			yy = 13: Spindle pitch in 1/100 mm (see chapter 8: Parameter description ⇒ Parameter no. 13)
			yy = 14: Node address (see chapter 8: Parameter description ⇒ Parameter no. 22)
			yy = 15: Stop mode inching 2 0 = Hard Stop 1 = Soft Stop (see chapter 8: Parameter description ⇒ Parameter no. 25)
			yy = 16: Inpos mode 0 = Position control 1 = Emf brake 2 = Enable (see chapter 8: Parameter description ⇒ Parameter no. 26)
			yy = 17: Loop length Spindle pitch = 0 -> increments Spindle pitch > 0 -> 1/100 mm (see chapter 8: Parameter description ⇒ Parameter no. 27)
			yy = 18: Contouring error limit (see chapter 8: Parameter description ⇒ Parameter no. 28)
			yy = 19: reserved
			yy = 20: reserved

Command	Length	Reply	Description
			yy = 21: reserved
			yy = 22: reserved
			yy = 23: reserved
			yy = 24: Current limiting [%] Range 25 – 110 % of nominal torque (see chapter 8: Parameter description ⇒ Parameter no. 29)
			yy = 25: Baud rate RS485 0 = 19200 1 = 57600 2 = 115200 (see chapter 8: Parameter description ⇒ Parameter no. 33)
			yy = 26: Bus Timeout Range 0 - 20 x100 ms (see chapter 8: Parameter description ⇒ Parameter no. 35)
			yy = 27: Inching 2 Offset Range 10 – 100 % der of inching speed (see chapter 8: Parameter description ⇒ Parameter no. 30)
			yy = 28: Key function enable 0 = all functions via key enabled 1 = all functions via key disabled (see chapter 8: Parameter description ⇒ Parameter no. 38)
			yy = 29: Key enable time Range 1 - 60 seconds (see chapter 8: Parameter description ⇒ Parameter no. 37)
			yy = 30: Display orientation 0 = 0° 1 = rotated by 180° (see chapter 8: Parameter description ⇒ Parameter no. 45)
			yy = 31: Display divisor 0 = 1 1 = 10 2 = 100 3 = 1000 (see chapter 8: Parameter description ⇒ Parameter no. 43)

Command	Length	Reply	Description
			yy = 32: Decimal places 0 = 0 1 = 0.0 2 = 0.00 3 = 0.000 4 = 0.0000 (see chapter 8: Parameter description ⇒ Parameter no. 42)
			yy = 33: Direction indication function 0 = On 1 = inverted 2 = Off (see chapter 8: Parameter description ⇒ Parameter no. 44)
			yy = 34: Encoder resolution (see chapter 8: Parameter description ⇒ Parameter no. 72)
			yy = 35: reserved
			yy = 36: LED 2 orange 0 = Off 1 = On (see chapter 8: Parameter description ⇒ Parameter no. 39)
			yy = 37: LED1 red 0 = Off 1 = On (see chapter 8: Parameter description ⇒ Parameter no. 40)
			yy = 38: LED1 green 0 = Off 1 = On (see chapter 8: Parameter description ⇒ Parameter no. 41)
			yy = 39: Inching mode 2 acceleration type 0 = static acceleration 1 = incremental acceleration (see chapter 8: Parameter description ⇒ Parameter no. 31)
			yy = 40: Protocol 0 = SIKONETZ5 1 = Service protocol (see chapter 8: Parameter description ⇒ Parameter no. 34)
			yy = 41: PIN change (see chapter 8: Parameter description ⇒ Parameter no. 48)
			yy = 42: Temporary key function enable 0 = Access as defined under Key function enable 1 = Access inverted as defined under Key function enable

Command	Length	Reply	Description
			yy = 43: Displayed value of 2 nd display line 0 = Set point 1 = Output stage temperature 2 = Control voltage 3 = Output stage voltage 4 = Battery voltage 5 = Motor current 6 = Actual position 7 = Actual rotational speed (see chapter 8: Parameter description ⇒ Parameter no. 49)
			yy = 44: Display divisor application (see chapter 8: Parameter description ⇒ Parameter no. 74)
Hyyxxxxx	8/2	">"	Enter 2-byte value yy = address xxxxx = decimal value
			yy = 00: Controller parameter P (see chapter 8: Parameter description ⇒ Parameter no. 1)
			yy = 01: Controller parameter I (see chapter 8: Parameter description ⇒ Parameter no. 2)
			yy = 02: Controller parameter D (see chapter 8: Parameter description ⇒ Parameter no. 3)
			yy = 03: a-Pos (see chapter 8: Parameter description ⇒ Parameter no. 4)
			yy = 04: v-Pos (see chapter 8: Parameter description ⇒ Parameter no. 5)
			yy = 05: a-rot (see chapter 8: Parameter description ⇒ Parameter no. 6)
			yy = 06: reserved
			yy = 07: a-Inch (see chapter 8: Parameter description ⇒ Parameter no. 8)
			yy = 08: v-Inch (see chapter 8: Parameter description ⇒ Parameter no. 9)
			yy = 09: Enter positioning window Spindle pitch = 0 -> increments Spindle pitch > 0 -> 1/100 mm (see chapter 8: Parameter description ⇒ Parameter no. 10)
			yy = 10: ü-numerator (see chapter 8: Parameter description ⇒ Parameter no. 11)
			yy = 11: ü-denominator (see chapter 8: Parameter description ⇒ Parameter no. 12)
			yy = 12: reserved
			yy = 13: Enter spindle pitch in 1/100 mm (see chapter 8: Parameter description ⇒ Parameter no. 13)
			yy = 14: Node address (see chapter 8: Parameter description ⇒ Parameter no. 22)

Command	Length	Reply	Description
			yy = 15: Stop mode inching 2 (see chapter 8: Parameter description ⇒ Parameter no. 25)
			yy = 16: Inpos mode (see chapter 8: Parameter description ⇒ Parameter no. 26)
			yy = 17: Loop length Spindle pitch = 0 -> increments Spindle pitch > 0 -> 1/100 mm (see chapter 8: Parameter description ⇒ Parameter no. 27)
			yy = 18: Contouring error limit (see chapter 8: Parameter description ⇒ Parameter no. 28)
			yy = 19: reserved
			yy = 20: reserved
			yy = 21: reserved
			yy = 22: reserved
			yy = 23: reserved
			yy = 24: Current limiting [%] (see chapter 8: Parameter description ⇒ Parameter no. 29)
			yy = 25: Baud rate RS485 (see chapter 8: Parameter description ⇒ Parameter no. 33)
			yy = 26: Bus Timeout (see chapter 8: Parameter description ⇒ Parameter no. 35)
			yy = 27: Inching 2 Offset (see chapter 8: Parameter description ⇒ Parameter no. 30)
			yy = 28: Key function enable 0 = all functions via key enabled 1 = all functions via key disabled (see chapter 8: Parameter description ⇒ Parameter no. 38)
			yy = 29: Key enable time (see chapter 8: Parameter description ⇒ Parameter no. 37)
			yy = 30: Display orientation (see chapter 8: Parameter description ⇒ Parameter no. 45)
			yy = 31: Display divisor (see chapter 8: Parameter description ⇒ Parameter no. 43)
			yy = 32: Display: Decimal places (see chapter 8: Parameter description ⇒ Parameter no. 42)
			yy = 33: Display: Direction indication function (see chapter 8: Parameter description ⇒ Parameter no. 44)
			yy = 34: reserved
			yy = 35: reserved
			yy = 36: LED 2 orange 0 = Off 1 = On (see chapter 8: Parameter description ⇒ Parameter no. 39)

Command	Length	Reply	Description
			yy = 37: LED 1 red 0 = Off 1 = On (see chapter 8: Parameter description ⇒ Parameter no. 40)
			yy = 38: LED 1 green 0 = Off 1 = On (see chapter 8: Parameter description ⇒ Parameter no. 41)
			yy = 39: Inching mode 2 acceleration type 0 = constant acceleration to final speed value 1 = incremental acceleration to final speed value (see chapter 8: Parameter description ⇒ Parameter no. 31)
			yy = 40: Protocol 0 = SIKONETZ5 1 = Service protocol (see chapter 8: Parameter description ⇒ Parameter no. 34)
			yy = 41: PIN change (see chapter 8: Parameter description ⇒ Parameter no. 48)
			yy = 42: Temporary key function enable 0 = Access as defined under Key function enable 1 = Access inverted as defined under Key function enable
			yy = 43: Displayed value of 2 nd display line 0 = Set point 1 = Output stage temperature 2 = Control voltage 3 = Output stage voltage 4 = Battery voltage 5 = Motor current 6 = Actual position 7 = Actual rotational speed (see chapter 8: Parameter description ⇒ Parameter no. 49)
			yy = 44: Display divisor application (see chapter 8: Parameter description ⇒ Parameter no. 74)
I	1/2	">"	Cancel current travel job in positioning mode Motor remains in control state
Jyy	3/6	"0xhh>"	Read out error memory
			yy = 00 number of errors in the error memory (see chapter 8: Parameter description ⇒ Parameter no. 61)
			yy = 01 Error 1 (see chapter 8: Parameter description ⇒ Parameter no. 62)
			yy = 02 Error 2 (see chapter 8: Parameter description ⇒ Parameter no. 63)

Command	Length	Reply	Description
			yy = 03 Error 3 (see chapter 8: Parameter description ⇒ Parameter no. 64)
			yy = 04 Error 4 (see chapter 8: Parameter description ⇒ Parameter no. 65)
			yy = 05 Error 5 (see chapter 8: Parameter description ⇒ Parameter no. 66)
			yy = 06 Error 6 (see chapter 8: Parameter description ⇒ Parameter no. 67)
			yy = 07 Error 7 (see chapter 8: Parameter description ⇒ Parameter no. 68)
			yy = 08 Error 8 (see chapter 8: Parameter description ⇒ Parameter no. 69)
			yy = 09 Error 9 (see chapter 8: Parameter description ⇒ Parameter no. 70)
			yy = 10 Error 10 (see chapter 8: Parameter description ⇒ Parameter no. 71)
			hh = value represented as hex
K	1/0		Software reset
Ly	2/2	">"	Enter positioning type y = 0: Direct positioning y = 1: Positioning with loop positive y = 2: Positioning with loop negative (see chapter 8: Parameter description ⇒ Parameter no. 19)
M	1/2	">"	Start of travel job Positioning mode: - start positioning process to programmed set point Rotational speed mode: - start of speed mode
N	1/2	">"	Motor stop fast Motor brakes with maximum deceleration. Motor remains in control state! Notice! If a contouring error is pending at the time of the 'N' command, the motor will be enabled.
O	1/2	">"	Motor stop Motor brakes with programmed deceleration. Motor remains in control state! Notice! If a contouring error is pending at the time of the 'O' command, the motor will be enabled.
P	1/2	">"	Enable motor

Command	Length	Reply	Description
Q	1/6	"0xhh>"	Output flag register hh = value (hex) x x x x x x x = binary representation of hh 7 6 5 4 3 2 1 0 Bit Bit 0: Sense of rotation: '0' = i (cw) '1' = e (ccw) Bit 1+2: Type of positioning: '00' = direct '01' = loop + '10' = loop - Bit 3: not assigned Bit 4: Operating mode: '0' = positioning mode '1' = speed mode Bit 5+6+7: not assigned
R	1/8	"0xhhll>"	Output system status word (hex) for the meaning of the individual bits see the Status word table hh = High Byte ll = Low Byte
Sxxxxx	6/2	">"	Reset device to basic state / system data x=11100: all parameters into basic state Notice! All parameter classes will be reset. After restart, the factory settings will be active, this applies to protocol and baud rate as well. x=11101: only standard parameters into basic state x=11102: only controller parameters into basic state x=11003: only display parameters into basic state x=11103: reset error x=11104: calibrate AG05 x=11105: delete primary error memory
Ty	2/2	">"	Enter sense of rotation y = 0: i sense of rotation (cw) y = 1: e sense of rotation (ccw) (see chapter 8: Parameter description ⇒ Parameter no. 18)
V	1/7	"±xxxx>"	Output actual rotational speed Unit rpm (see chapter 8: Parameter description ⇒ Parameter no. 56)
W	1/4	"xxxx"	Binary position value xxxx = 4 bytes in 2-complement MSB ... LSB (see chapter 8: Parameter description ⇒ Parameter no. 55)

Command	Length	Reply	Description
Xy	2/2	">"	Enter operation mode y = 0 Positioning mode y = 1 Speed mode (see chapter 8: Parameter description ⇒ Parameter no. 20)
Y	1/2	">"	Start of inching mode 1 (only in positioning mode)
Z	1/10	"±xxxxxxx>"	Output position value (see chapter 8: Parameter description ⇒ Parameter no. 55)
, (2C _{hex})	1/0		Travelling in inching mode 2 positive Actuator travels in positive direction as long as ',' sign is permanently sent (only in positioning mode).
. (2E _{hex})	1/0		Travelling in inching mode 2 negative Actuator travels in negative direction as long as '.' sign is permanently sent (only in positioning mode).

Table 16: Service protocol commands list

9.4 Error number encoding

Code	Description
?01	Input of illegal parameter number
?02	Illegal value range
?03	No authorization (active control via Profibus/CAN-Bus)
?04	Input disabled due to operating state
?07	Upper software limit exceeded
?08	Lower software limit exceeded
?09	Set point entered exceeds limiting value
?10	Error
?11	EEPROM write access active
?12	Set point < range limit
?13	Set point > range limit

Table 17: Error number encoding

9.5 Flow chart: Operating mode: Positioning mode

The flow chart below shows the control of positioning in the positioning mode via service protocol (see chapter 9: Service Protocol).

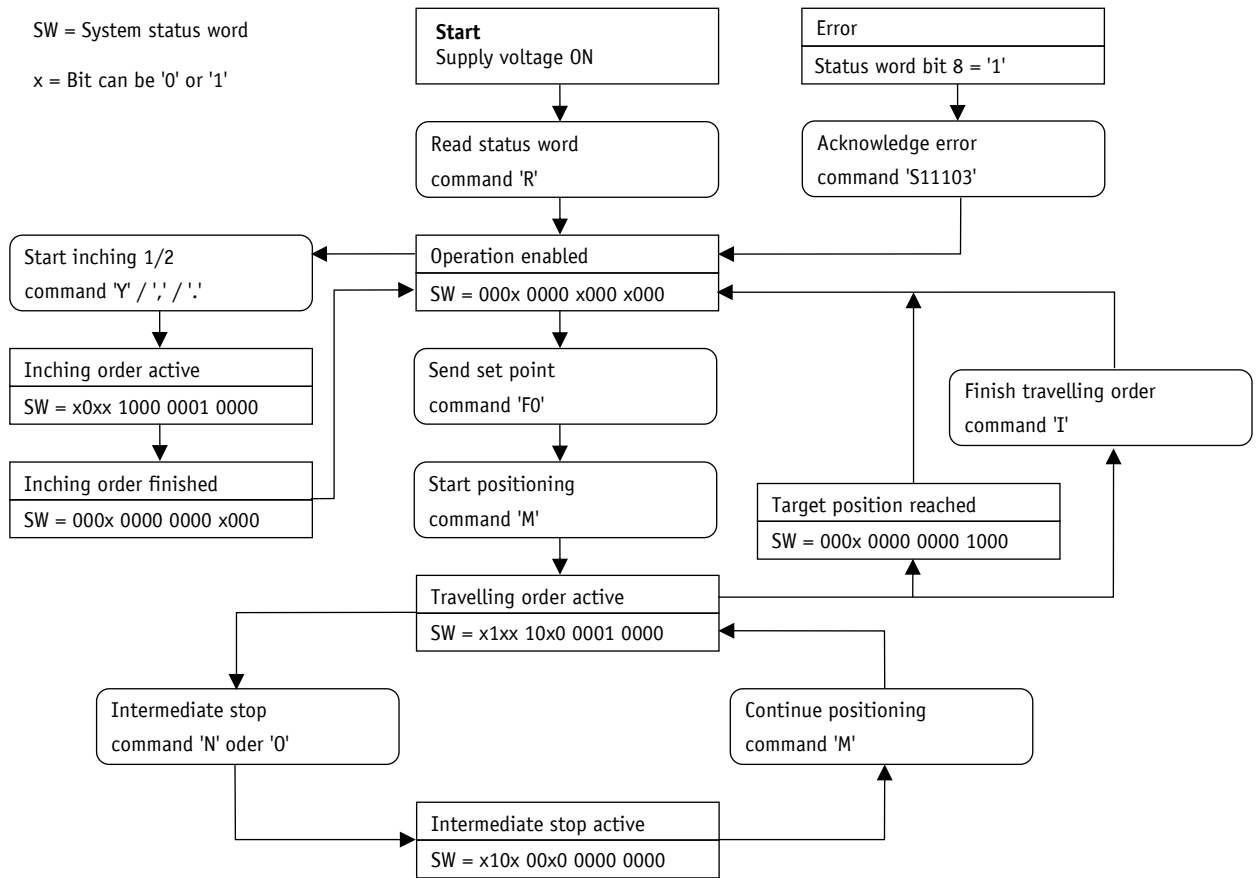

Fig. 8: Flow chart positioning mode service protocol

9.6 Flow chart: Operating mode: Speed mode

The flow chart below illustrates the control in the rotational speed mode via service protocol (see chapter 9: Service Protocol).

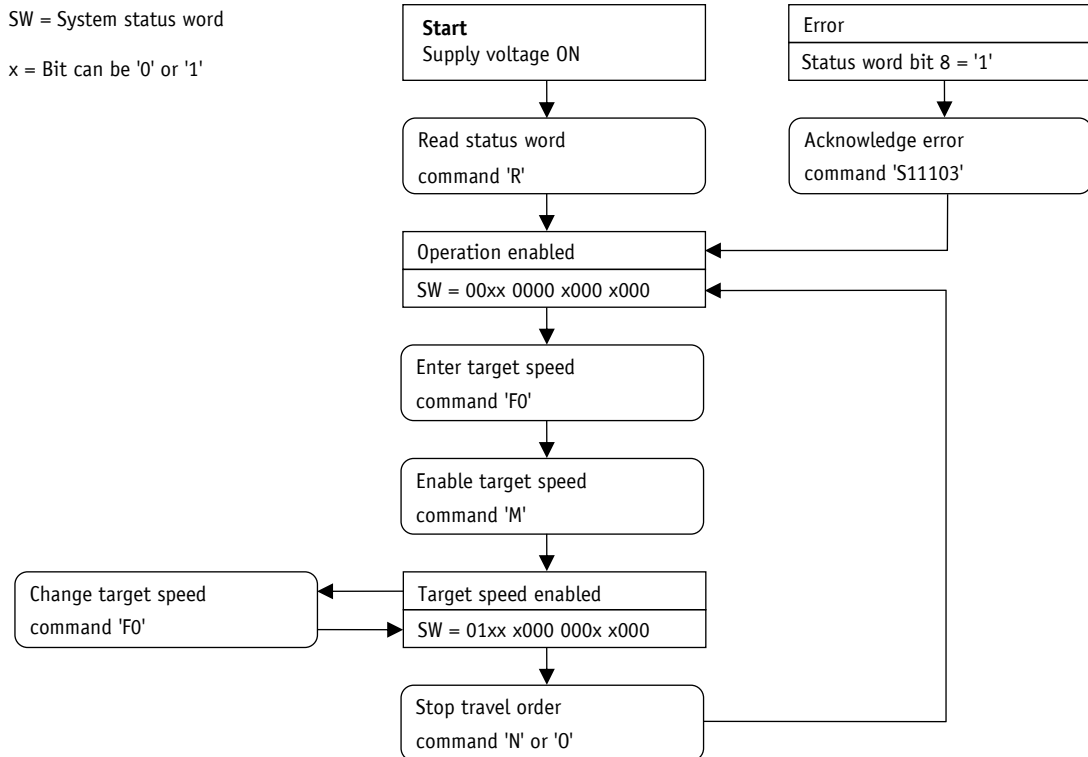

Fig. 9: Flow chart Rotational speed mode service protocol

10 Communication via SIKONETZ5

10.1 Interface

Schnittstelle RS485

Available baud rates: 19.2 kBit / 57.6 kBit / 115.2 kBit

No parity, 8 data bits, 1 stop bit, no handshake

10.2 Data exchange

The protocol functions according to the master – slave principle.

The actuator acts as a slave. Every instance of communication must be initiated by the master. When the master has sent a command telegram, the slave sends a reply telegram. Broadcast commands are an exception, they remain always unanswered by the slave.

The protocol is optimized for cyclical data exchange. The relevant data such as set point and actual value can be transferred between master and slave by a single telegram exchange.

The parameter to be returned by the slave as a reply to the master's Write set point command can be defined via the "Write set point reply parameter".

10.3 Telegram setup

CW, SW and data are transferred in the Big-Endian format.

Command telegram (from master)

1 st byte	2 nd byte	3 rd byte	4 th byte	5 th byte	6 th byte	7 th byte	8 th byte	9 th byte	10 th byte
Command	Node ID	Parameter address	CW		Data				Check sum

Reply telegramm (from slave)

1 st byte	2 nd byte	3 rd byte	4 th byte	5 th byte	6 th byte	7 th byte	8 th byte	9 th byte	10 th byte
Reply	Node ID	Parameter address	SW		Data				Check sum

10.3.1 Command

0x00 = read

0x01 = write

0x02 = broadcast

10.3.2 Node ID

Node address (see chapter 8: [Parameter description](#) ⇒ [Parameter no. 22](#)).

10.3.3 Parameter address

Description, see chapter 10.9: [Parameterization via SIKONETZ5](#).

10.3.4 Control word

Control word (CW) master to slave.

10.3.5 Status word

Status word (SW) slave to master.

10.3.6 Data

Range for data exchange. Size: 4 bytes.

10.3.7 Check sum

For checking error-free data transfer, a check sum is formed at the end of the telegram. The check sum is the exclusive-OR-link of bytes 1 – 9:

Check sum [Byte10] =

[Byte1] XOR [Byte2] XOR [Byte3] XOR [Byte4] XOR [Byte5] XOR [Byte6] XOR [Byte7] XOR [Byte8] XOR [Byte9]

The following applies for checking the telegram received:

[Byte1] XOR [Byte2] XOR [Byte3] XOR [Byte4] XOR [Byte5] XOR [Byte6] XOR [Byte7] XOR [Byte8] XOR [Byte9] XOR [Byte 10] = 0

With a result unequal 0 a transmission error is to be assumed.

10.4 Synchronization

Byte/telegram synchronization is via "Timeout". The intervals between the individual bytes of a telegram must not exceed the value of 10 ms. If an addressed device does not respond, the master must not send another telegram earlier than after 30 ms.

10.5 Error telegram

Illegal entries are replied with an error telegram.

An error telegram consists of parameter address 0xFD and an error code.

The error code is in the data section of the reply telegram. The error code is divided in two bytes. Code 1 describes the error proper and code 2 contains additional information if available.

In the following example an attempt was made at writing a value of 1000 to the v-Pos parameter address.

However, a maximum value of only 30 is admissible for this parameter.

Telegram from master to slave

1 st byte	2 nd byte	3 rd byte	4 th byte	5 th byte	6 th byte	7 th byte	8 th byte	9 th byte	10 th byte
Command	Node ID	Parameter address	CW		Data				Check sum
0x01	0x01	0x14	0x00	0x00	0x00	0x00	0x03	0xE8	0xFF

Reply telegram from slave

1 st byte	2 nd byte	3 rd byte	4 th byte	5 th byte	6 th byte	7 th byte	8 th byte	9 th byte	10 th byte	
Command	Node ID	Parameter address	SW		Data			Code2	Code1	Check sum
0x01	0x01	0xFD	0x00	0x21	0x00	0x00	0x02	0x82	0x5C	

10.5.1 SIKONETZ5 error codes

Code 1	Description	Code 2	Description
0x80	Check sum SIKONETZ5	0x00	no further information available
0x81	Timeout SIKONETZ5	0x00	no further information available
0x82	Value range exceeded / inadequate	0x00	no further information available
		0x01	Value < MIN
		0x02	Value > MAX
0x83	Unknown parameter	0x00	no further information available
0x84	Access is not supported	0x00	no further information available
		0x01	write attempt to read only
		0x02	read attempt to write only
0x85	Error due to device status	0x00	no further information available
		0x01	EEPROM write access active
		0x02	Positioning active
		0x03	Programming locked

Table 18: SIKONETZ5 error codes

10.6 Errors

If a slave is in the error state the slave signals this state with SW.7 = 1.

Errors must be acknowledged by CW.5 = 0/1. If the cause of the error has not been resolved at the time of acknowledgement, the error will not be reset.

After acknowledgement of an error, the slave is in the switch-lock state. The switch-lock can be released via a negative flank on CW.0 or CW.1 or CW.2.

Errors are stored in the error memory and can be read out.

In order to receive the last error occurring the number of errors must first be read in parameter address 0x80.

With 0x80 + number of errors the parameter address with the latest error is received. Under this address the error code is found (see chapter 7.2.1: [Error codes](#)).

10.7 Communication monitoring

10.7.1 Bus Timeout

The first telegram received by the slave starts time monitoring.

Every new telegram recognized as valid by the slave (correct check sum) triggers time monitoring.

If timeout occurs during an active travel job, this will result in the Timeout error, i. e. the current travel job is cancelled. Thus, a broken cable can be detected for instance and the actuator set into a defined state.

For this purpose the master must address all slaves cyclically (see chapter 8: [Parameter description](#) ⇒ [Parameter no. 35](#)).

10.7.2 Locking the programming mode

Locking of programming is controlled via parameter "Programming mode: Configuration" (see chapter 8: [Parameter description](#) ⇒ [Parameter no. 46](#)). If it is activated, locking must be disabled by a write command on parameter "Programming mode" (see chapter 8: [Parameter description](#) ⇒ [Parameter no. 47](#)) prior to write access to a parameter which is stored non-volatily in the device. Correspondingly, locking should be re-enabled immediately after write access. This approach enhances protection from unwanted configuration. Write access to locked parameters is answered with "Error due to device status" (see chapter 10.5.1: [SIKONETZ5 error codes](#)).

10.8 Functional description of the control units

10.8.1 Control word: Positioning mode (master ⇒ slave)

Bit	Description
Bit 0 OFF1 (enable)	0 = OFF1 active Current travel job is cancelled. The actuator is activated.
	1 = OFF1 inactive
Bit 1 OFF2 (max. deceleration)	0 = OFF2 active Current travel job is cancelled. The actuator is decelerated with max. deceleration, the actuator continues to be controlled.
	1 = OFF2 inactive
Bit 2 OFF3 (program. deceleration)	0 = OFF3 active Current travel job is cancelled. The actuator is decelerated with progr. deceleration, the actuator continues to be controlled.
	1 = OFF3 inactive
Bit 3 Intermediate stop	0 = no intermediate stop
	1 = intermediate stop active
Bit 4 Start travel job	Positive flank starts a travel job.
Bit 5 Acknowledge error	Positive flank acknowledges an error. Afterwards, the actuator changes to the switch-lock state.
Bit 6 Inching mode 1	0 = no inching mode1 If the travel job is not completed yet it will be cancelled.
	1 = inching operation 1 As soon as this bit is set, the actuator travels the distance specified in parameter Delta Tipp.

Bit	Description
Bit 7 Inching mode 2 positive	0 = no inching mode 2 positive 1 = inching mode 2 positive The actuator travels in positive direction.
Bit 8 Inching mode 2 negative	0 = no inching mode 2 negative 1 = inching mode 2 negative The actuator travels in negative direction.
Bit 9 Key enable	0 = key enable as defined by parameter 0x05 1 = key enable inverted as defined by parameter 0x05
Bit 10 -15	Reserved, always 0

Table 19: Control word positioning mode SIKONETZ5

10.8.2 Status word: Positioning mode (slave ⇒ master)

Bit	Description
Bit 0 Supply	0 = Output stage voltage missing 1 = Supply voltage of the output stage is applied
Bit 1 Readiness to travel	0 = not ready to travel 1 = ready to travel
Bit 2 Upper limit	0 = no violation of limit 1 = upper limit exceeded
Bit 3 Lower limit	0 = no violation of limit 1 = lower limit undercut
Bit 4 Actuator travels / stands still	0 = actuator stands still 1 = actuator travels
Bit 5 Inpos	0 = Actuator is outside the positioning window 1 = Actuator is inside the positioning window
Bit 6 Active travel job	0 = no active travel job 1 = active travel job
Bit 7 Error	0 = no error 1 = Error Acknowledgement with positive flank on control word bit 5.
Bit 8 Operation enabled	0 = operation not enabled 1 = operation enabled
Bit 9 Switch-lock	0 = no switch-lock 1 = switch-lock
Bit 10 Travel job acknowledgement	0 = no acknowledgement 1 = acknowledgement The bit is set after the travel job was adopted. If bit 4 is reset in the control word, this bit will be reset as well.

Bit	Description
Bit 11 Battery warning	0 = no warning, battery loading state is OK 1 = Battery warning Battery voltage is below 2.6 V. Battery change is required.
Bit 12 Current limiting	0 = current limiting inactive 1 = current limiting active Motor current exceeds the value set under parameter 0x2C.

Table 20: Status word positioning mode SIKONETZ5

10.8.3 Flow chart: Positioning mode

CW = Control word SIKONETZ5
 SW = Status word SIKONETZ5
 x = Bit can be '0' or '1'

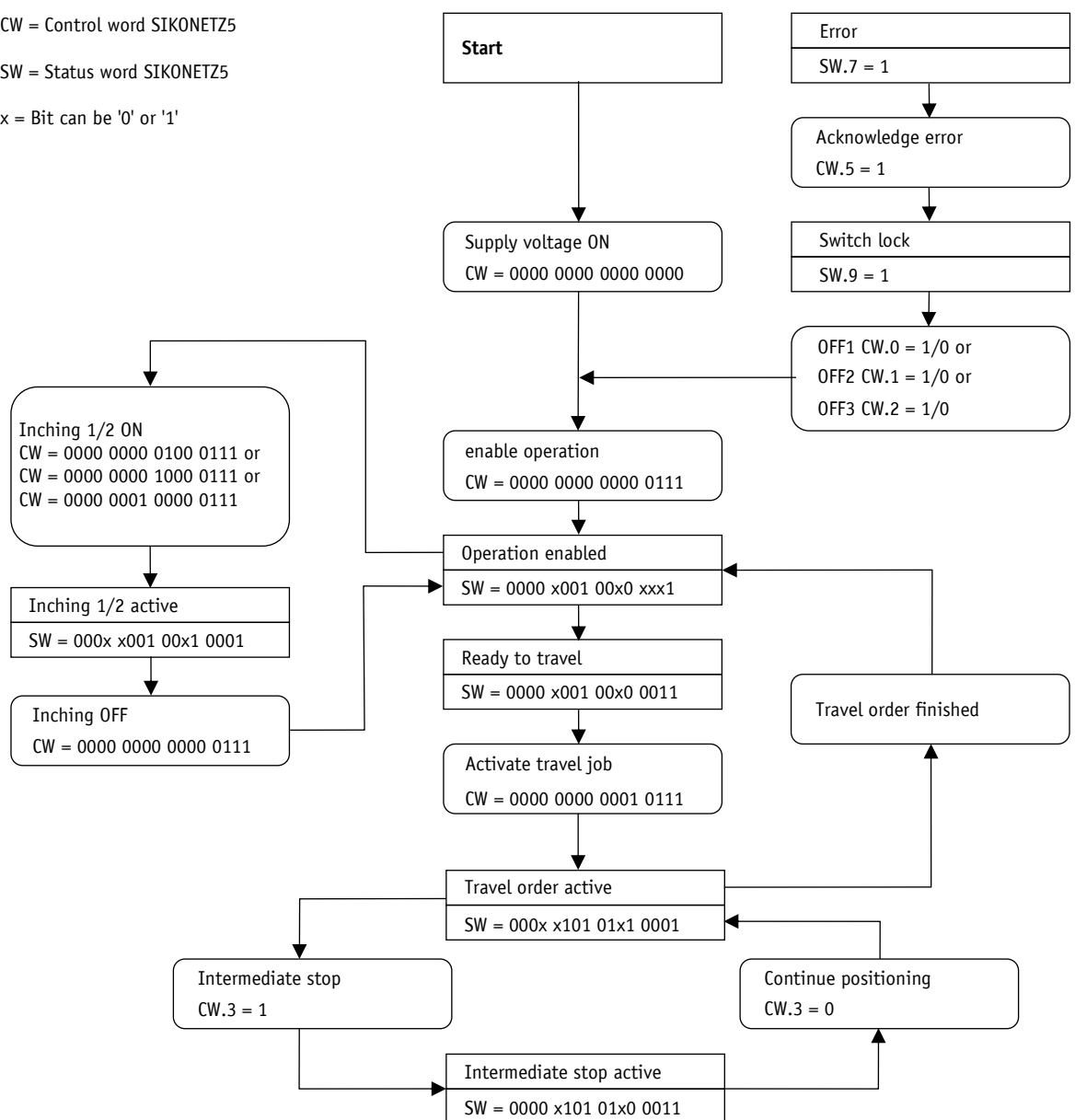

Fig. 10: Flow chart positioning mode SIKONETZ5

10.8.4 Control word Operating mode: Speed mode

Bit	Description
Bit 0 OFF1 (enable)	0 = OFF1 active Current travel job is cancelled. The actuator is activated.
	1 = OFF1 inactive
Bit 1 OFF2 (max. deceleration)	0 = OFF2 active Current travel job is cancelled. The actuator is decelerated with max. deceleration, the actuator continues to be controlled.
	1 = OFF2 inactive
Bit 2 OFF3 (progr. deceleration)	0 = OFF3 active Current travel job is cancelled. The actuator is decelerated with progr. deceleration, the actuator continues to be controlled.
	1 = OFF3 inactive
Bit 3	Reserved, always 0
Bit 4 Start travel job	Positive flank starts a travel job.
Bit 5 Acknowledge error	Positive flank acknowledges an error. Afterwards, the actuator changes to the switch-lock state.
Bit 6	Reserved, always 0
Bit 7	Reserved, always 0
Bit 8	Reserved, always 0
Bit 9 Key enable	0 = key enable as defined by parameter 0x05
	1 = key enable inverted as defined by parameter 0x05
Bit 10 -15	Reserved, always 0

Table 21: Control word speed mode SIKONETZ5

10.8.5 Status word: Speed mode

Bit	Description
Bit 0 Supply	0 = Output stage voltage missing
	1 = Supply voltage of the output stage is applied
Bit 1 Readiness to travel	0 = not ready to travel
	1 = ready to travel
Bit 2	no function
Bit 3	no function
Bit 4 Actuator travels / stands still	0 = actuator stands still
	1 = actuator travels
Bit 5 Inpos	0 = Actuator is outside the position window
	1 = Actuator is inside the position window

Bit	Description
Bit 6 Active travel job	0 = no active travel job
	1 = active travel job
Bit 7 Error	0 = no error
	1 = Error Acknowledgement with positive flank on control word bit 5.
Bit 8 Operation enabled	0 = operation not enabled
	1 = operation enabled
Bit 9 Switch-lock	0 = no switch-lock
	1 = switch-lock
Bit 10 Travel job acknowledgement	0 = no acknowledgement
	1 = acknowledgement The bit is set when the travel job was adopted. If bit 4 is reset in the control word, this bit will be reset as well.
Bit 11 Battery warning	0 = no warning, battery loading state is OK
	1 = Battery warning Battery voltage is below 2.6 V. Battery change is required.
Bit 12 Current limiting	0 = current limiting inactive
	1 = current limiting active Motor current exceeds the value set under parameter 0x2C.

Table 22: Status word speed mode SIKONETZ5

10.8.6 Flow chart: Operating mode: Speed mode

CW = Control word SIKONETZ5
 SW = Status word SIKONETZ5
 x = Bit can be '0' or '1'

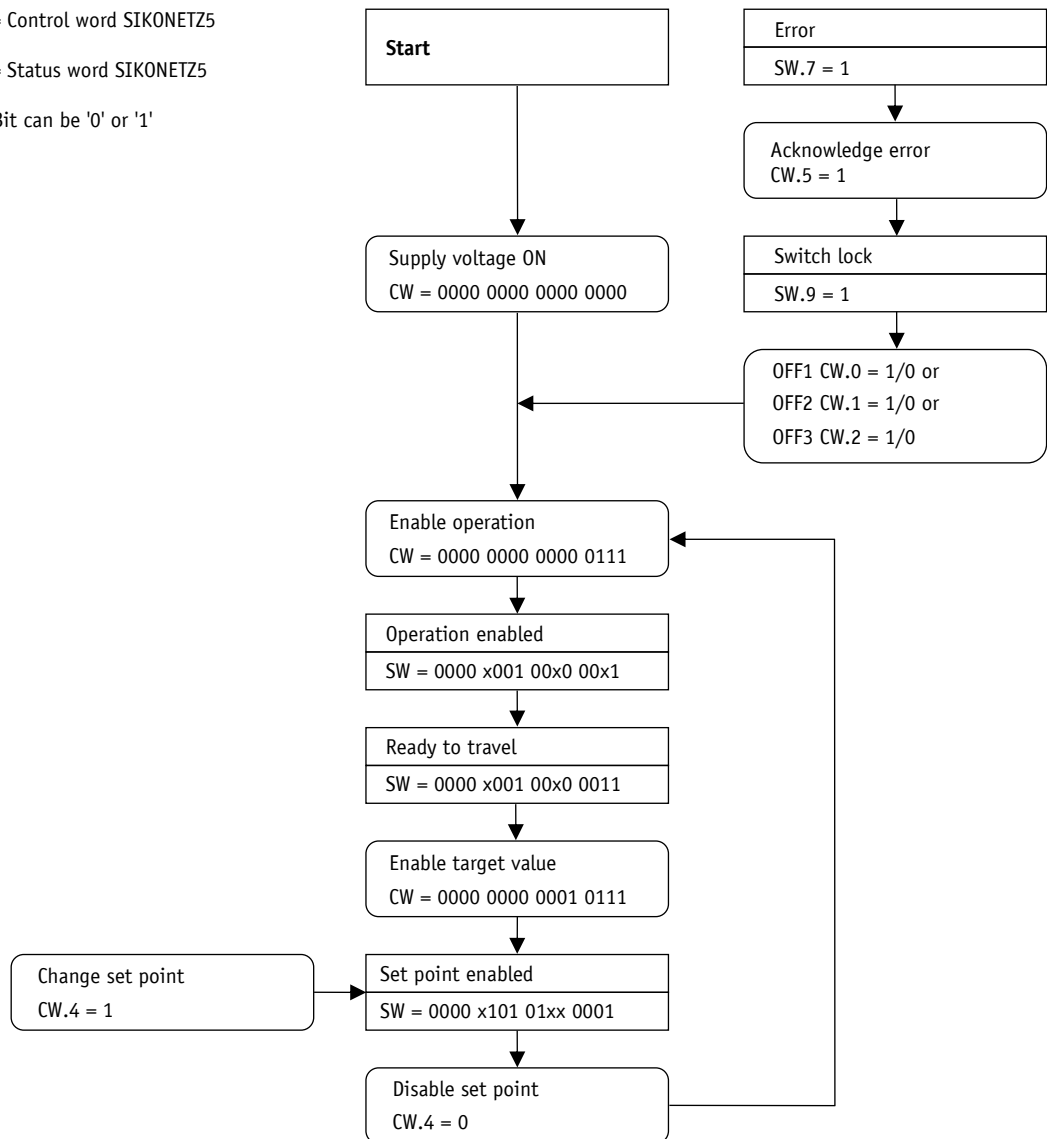

Fig. 11: Flow chart speed mode SIKONETZ5

10.9 Parameterization via SIKONETZ5

On principle, the actuator sends a telegram acknowledging write and read commands of the master. With the command executable the value adopted is in the reply telegram.

If the actuator was unable to execute the command, e. g. because it attempted to write a value beyond the admissible range, the actuator will send an error telegram in reply.

Access

rw = read write
 ro = read only
 wo = write only

Parameter no. [hex]	Name	Access	Format	Description
0x00	Node address	rw	Unsigned8	Value range 0 - 31 Setting of node address Parameter changes become active only after cold start or software reset. (see chapter 8: Parameter description ⇒ Parameter no. 22)
0x01	Baud rate	rw	Unsigned8	Setting the baud rate 0 = 19200 1 = 57600 2 = 115200 Parameter changes become active only after cold start or software reset. (see chapter 8: Parameter description ⇒ Parameter no. 33)
0x02	Bus Timeout	rw	Unsigned16	Value range 0 – 20 (see chapter 8: Parameter description ⇒ Parameter no. 35)
0x03	Reply parameter to write set point command	rw	Unsigned8	0 = Set point 1 = Actual value 2 = Output stage temperature 3 = Control voltage 4 = Output stage voltage 5 = Battery voltage 6 = Motor current 7 = Actual position 8 = Actual rotational speed (see chapter 8: Parameter description ⇒ Parameter no. 36)
0x04	Enable keys time	rw	Unsigned8	Value range 1 – 60 (see chapter 8: Parameter description ⇒ Parameter no. 37)
0x05	Key function enable	rw	Unsigned8	0 = key function free 1 = key function locked (see chapter 8: Parameter description ⇒ Parameter no. 38)
0x07	LED 2 orange	rw	Unsigned8	0 = LED 2 Off 1 = LED 2 On (see chapter 8: Parameter description ⇒ Parameter no. 39)
0x08	LED 1 red	rw	Unsigned8	0 = LED 1 red Off 1 = LED 1 red On (see chapter 8: Parameter description ⇒ Parameter no. 40)

Parameter no. [hex]	Name	Access	Format	Description
0x09	LED 1 green	rw	Unsigned8	0 = LED 1 green Off 1 = LED 1 green On (see chapter 8: Parameter description ⇒ Parameter no. 41)
0x0A	Decimal places	rw	Unsigned8	Value range 0 – 4 (see chapter 8: Parameter description ⇒ Parameter no. 42)
0x0B	Display divisor	rw	Unsigned8	Value range 0 – 3 (see chapter 8: Parameter description ⇒ Parameter no. 43)
0x0C	Direction indication function	rw	Unsigned8	Value range 0 – 2 (see chapter 8: Parameter description ⇒ Parameter no. 44)
0x0D	Display orientation	rw	Unsigned8	0 = normal 1 = rotated by 180° (see chapter 8: Parameter description ⇒ Parameter no. 45)
0x0E	Programming mode configuration	rw	Unsigned8	0 = no programming mode 1 = apply programming mode (see chapter 8: Parameter description ⇒ Parameter no. 46)
0x0F	PIN change	rw	Unsigned32	Value range 0 – 99999 (see chapter 8: Parameter description ⇒ Parameter no. 48)
0x10	Controller parameter P	rw	Unsigned16	Value range 1 – 500 (see chapter 8: Parameter description ⇒ Parameter no. 1)
0x11	Controller parameter I	rw	Unsigned16	Value range 0 – 500 (see chapter 8: Parameter description ⇒ Parameter no. 2)
0x12	Controller parameter D	rw	Unsigned16	Value range 0 – 500 (see chapter 8: Parameter description ⇒ Parameter no. 3)
0x13	a - Pos	rw	Unsigned8	Value range 1 – 100 (see chapter 8: Parameter description ⇒ Parameter no. 4)
0x14	v - Pos	rw	Unsigned8	Gear 66:1 ⇒ value range: 1 - 75 Gear 98:1 ⇒ value range: 1 - 50 (see chapter 8: Parameter description ⇒ Parameter no. 5)
0x15	a - rot	rw	Unsigned8	Value range 1 – 100 (see chapter 8: Parameter description ⇒ Parameter no. 6)

Parameter no. [hex]	Name	Access	Format	Description
0x16	a - inch	rw	Unsigned8	Value range 1 – 100 (see chapter 8: Parameter description ⇒ Parameter no. 8)
0x17	v - inch	rw	Unsigned8	Gear 66:1 ⇒ value range: 1 - 75 Gear 98:1 ⇒ value range: 1 – 50 (see chapter 8: Parameter description ⇒ Parameter no. 9)
0x18	ü - Numerator	rw	Unsigned16	Value range 1 – 10000 (see chapter 8: Parameter description ⇒ Parameter no. 11)
0x19	ü - Denominator	rw	Unsigned16	Value range 1 – 10000 (see chapter 8: Parameter description ⇒ Parameter no. 12)
0x1A	Encoder resolution	ro	Unsigned16	Constant Value 720
0x1B	Sense of rotation	rw	Unsigned8	0 = i sense of rotation (cw) 1 = e sense of rotation (ccw) (see chapter 8: Parameter description ⇒ Parameter no. 18)
0x1C	Spindle pitch	rw	Unsigned16	Value range 0 – 1000000 (see chapter 8: Parameter description ⇒ Parameter no. 13)
0x1E	Offset	rw	Integer32	Value range -999999 ... 999999 (see chapter 8: Parameter description ⇒ Parameter no. 32)
0x1F	Calibration value	rw	Integer32	Value range -999999 ... 999999 (see chapter 8: Parameter description ⇒ Parameter no. 14)
0x20	Pos- window	rw	Unsigned16	Value range 0 – 1000 (see chapter 8: Parameter description ⇒ Parameter no. 10)
0x21	Pos type	rw	Unsigned8	0 = direct 1 = loop + 2 = loop – (see chapter 8: Parameter description ⇒ Parameter no. 19)
0x22	Loop length	rw	Unsigned16	Value range 0 – 30000 (see chapter 8: Parameter description ⇒ Parameter no. 27)
0x23	Inpos mode	rw	Unsigned8	0 = position control 1 = short circuit of the motor windings 2 = motor activated (see chapter 8: Parameter description ⇒ Parameter no. 26)

Parameter no. [hex]	Name	Access	Format	Description
0x24	Delta Inch	rw	Integer32	Value range -1000000 ... 1000000 (see chapter 8: Parameter description ⇒ Parameter no. 17)
0x25	Acceleration type with Inching mode 2	rw	Unsigned8	0 = static acceleration 1 = incremental acceleration (see chapter 8: Parameter description ⇒ Parameter no. 31)
0x26	Inching 2 Offset	rw	Unsigned8	Value range 10 – 100 (see chapter 8: Parameter description ⇒ Parameter no. 30)
0x27	Stop mode inching 2	rw	Unsigned8	0 = maximum deceleration 1 = programmed deceleration (see chapter 8: Parameter description ⇒ Parameter no. 25)
0x28	Operating mode	rw	Unsigned8	0 = positioning mode 1 = speed mode (see chapter 8: Parameter description ⇒ Parameter no. 20)
0x29	Limit 1	rw	Integer32	Value range -9999999 ... 9999999 (see chapter 8: Parameter description ⇒ Parameter no. 15)
0x2A	Limit 2	rw	Integer32	Value range -9999999 ... 9999999 (see chapter 8: Parameter description ⇒ Parameter no. 16)
0x2C	Current limiting	rw	Unsigned8	Value range 25 – 110 (see chapter 8: Parameter description ⇒ Parameter no. 29)
0x2D	Contouring error limit	rw	Unsigned16	Value range 1 – 30000 (see chapter 8: Parameter description ⇒ Parameter no. 28)
0x30	Display value of 2 nd line	rw	Unsigned8	0 = Set point 1 = Output stage temperature 2 = Control voltage 3 = Output stage voltage 4 = Battery voltage 5 = Motor current 6 = Actual position 7 = Actual rotational speed (see chapter 8: Parameter description ⇒ Parameter no. 49)
0x33	Display divisor application	rw	Unsigned8	(see chapter 8: Parameter description ⇒ Parameter no. 74)
0x60	Output stage temperature	ro	Integer16	Temperature values in 1/10 °C (see chapter 8: Parameter description ⇒ Parameter no. 50)

Parameter no. [hex]	Name	Access	Format	Description
0x61	Voltage of control	ro	Integer16	Voltage values in 1/10 V (see chapter 8: Parameter description ⇒ Parameter no. 51)
0x62	Voltage of output stage	ro	Integer16	Voltage values in 1/10 V (see chapter 8: Parameter description ⇒ Parameter no. 52)
0x63	Voltage of battery	ro	Integer16	Voltage values in 1/100 V (see chapter 8: Parameter description ⇒ Parameter no. 53)
0x64	Motor current	ro	Integer16	Current values in mA (see chapter 8: Parameter description ⇒ Parameter no. 54)
0x65	Device code	ro	Unsigned8	0 = AG05
0x66	Display controller software version	ro	Unsigned16	Version number e. g. 103 corresponds to V1.03 (see chapter 8: Parameter description ⇒ Parameter no. 60)
0x67	Motor controller software version	ro	Unsigned16	Version number e. g. 108 corresponds to V1.08 (see chapter 8: Parameter description ⇒ Parameter no. 59)
0x68	Serial number	ro	Unsigned32	Serial number (see chapter 8: Parameter description ⇒ Parameter no. 57)
0x69	Production date	ro	Unsigned32	Production date in DDMMYYYY format (see chapter 8: Parameter description ⇒ Parameter no. 58)
0x6A	Gear reduction	ro	Unsigned16	66 = gear 66:1 98 = gear 98:1
0x6B	Actual position	ro	Integer32	Spindle pitch = 0 values in increments Spindle pitch > 0 values in 1/100 mm (see chapter 8: Parameter description ⇒ Parameter no. 55)
0x6C	Actual rotational speed	ro	Integer32	Actual speed in rpm (see chapter 8: Parameter description ⇒ Parameter no. 56)
0x80	Number of errors	ro	Unsigned8	Returns the number of errors in the error memory. (see chapter 8: Parameter description ⇒ Parameter no. 61)
0x81	Error 1	ro	Unsigned8	see chapter 7.2.1: Error codes (see chapter 8: Parameter description ⇒ Parameter no. 62)

Parameter no. [hex]	Name	Access	Format	Description
0x82	Error 2	ro	Unsigned8	see chapter 7.2.1: Error codes (see chapter 8: Parameter description ⇒ Parameter no. 63)
0x83	Error 3	ro	Unsigned8	see chapter 7.2.1: Error codes (see chapter 8: Parameter description ⇒ Parameter no. 64)
0x84	Error 4	ro	Unsigned8	see chapter 7.2.1: Error codes (see chapter 8: Parameter description ⇒ Parameter no. 65)
0x85	Error 5	ro	Unsigned8	see chapter 7.2.1: Error codes (see chapter 8: Parameter description ⇒ Parameter no. 66)
0x86	Error 6	ro	Unsigned8	see chapter 7.2.1: Error codes (see chapter 8: Parameter description ⇒ Parameter no. 67)
0x87	Error 7	ro	Unsigned8	see chapter 7.2.1: Error codes (see chapter 8: Parameter description ⇒ Parameter no. 68)
0x88	Error 8	ro	Unsigned8	see chapter 7.2.1: Error codes (see chapter 8: Parameter description ⇒ Parameter no. 69)
0x89	Error 9	ro	Unsigned8	see chapter 7.2.1: Error codes (see chapter 8: Parameter description ⇒ Parameter no. 70)
0x8A	Error 10	ro	Unsigned8	see chapter 7.2.1: Error codes (see chapter 8: Parameter description ⇒ Parameter no. 71)
0xA0	S command	wo	Unsigned16	1 = all parameters to default Notice! All parameter classes will be reset. After restart, the factory settings will be active, this applies to node address and baud rate as well. 2 = only standard parameters to default 3 = controller parameters to default 4 = display parameters to default 5 = bus parameters to default 6 = reset error 7 = calibration 8 = delete error memory 9 = software reset

Parameter no. [hex]	Name	Access	Format	Description
0xA8	Programming mode On / Off temporary	wo	Unsigned8	Depending on the programming mode configuration parameter Programming mode configuration = 0 no function Programming mode configuration = 1 0 = Programming mode Off Write parameter disabled. Write attempts are acknowledged with an error message. 1 = Programming mode On Write parameter enabled.
0xAA	Freeze actual value	wo	Unsigned8	1 = freeze actual value The current actual value is cached until next reading of actual value
0xFA	System status word	ro	Unsigned16	(see chapter 9.2: System Status Word)
0xFE	Actual value	ro	Integer32	Positioning mode Actual position Rotational speed mode Actual rotational speed
0xFF	Set point	rw	Integer32	Positioning mode Target position Rotational speed mode Target rotational speed

Table 23: Parameter description SIKONETZ5

10.9.1 Example: Read parameter

Reading the parameter Limit 1 of node address 1:

NOTICE	With read commands the data range shall be set to value 0.
---------------	--

Read command: 0x00

Node ID: 0x01

Parameter address: 0x29 Limit1

Data: 0x00 00 00 00

Telegram from master to slave

1 st byte	2 nd byte	3 rd byte	4 th byte	5 th byte	6 th byte	7 th byte	8 th byte	9 th byte	10 th byte
Command	Node ID	Parameter address	CW		Data				Check sum
0x00	0x01	0x29	0x00	0x00	0x00	0x00	0x00	0x00	0x28

Reply telegram from slave

1 st byte	2 nd byte	3 rd byte	4 th byte	5 th byte	6 th byte	7 th byte	8 th byte	9 th byte	10 th byte
Command / reply	Node ID	Parameter address	SW		Data				Check sum
0x00	0x01	0x29	0x00	0x01	0x00	0x01	0x86	0x9F	0x31

The reply telegram contains the current value of parameter limit 1.

Data: 0x00 01 86 9F \Rightarrow 99 999_{dec}

10.9.2 Example: Write parameter

Set parameter v-Pos of node address 1 to value 15:

Write command: 0x01

Node ID: 0x01

Parameter address: 0x14 v-Pos

Data: 0x00 00 00 0F

Telegram from master to slave

1 st byte	2 nd byte	3 rd byte	4 th byte	5 th byte	6 th byte	7 th byte	8 th byte	9 th byte	10 th byte
Command	Node ID	Parameter address	CW		Data				Check sum
0x01	0x01	0x14	0x00	0x00	0x00	0x00	0x00	0x0F	0x1B

Reply telegram from slave

1 st byte	2 nd byte	3 rd byte	4 th byte	5 th byte	6 th byte	7 th byte	8 th byte	9 th byte	10 th byte
Command / reply	Node ID	Parameter address	SW		Data				Check sum
0x01	0x01	0x14	0x00	0x01	0x00	0x00	0x00	0x0F	0x1A