

Selection diagram

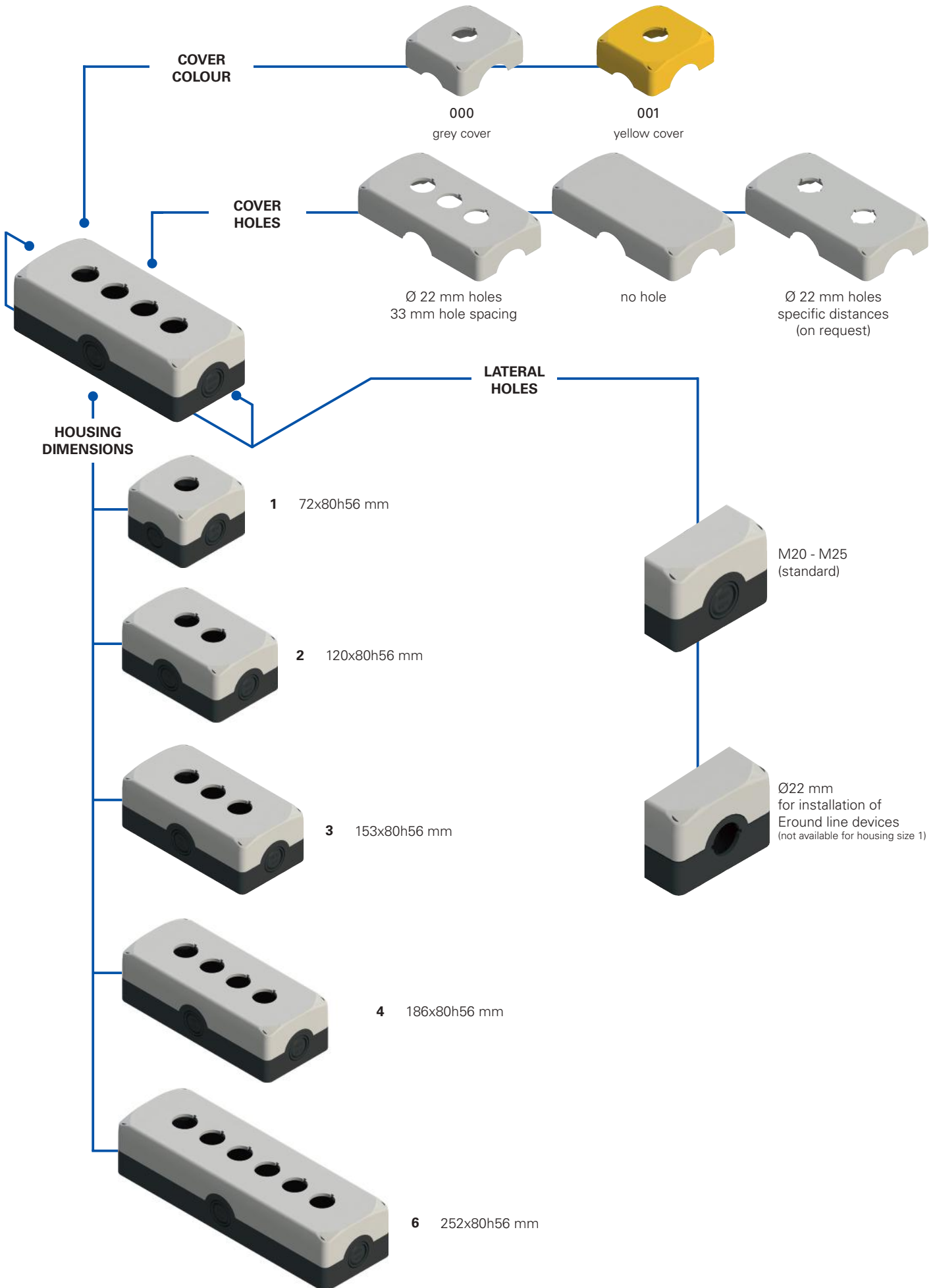

Code structure**Attention!** The feasibility of a code number does not mean the effective availability of a product. Please contact our sales office.

ES 31000

Body material**3** polycarbonate PC (standard)**Configuration****000** black base, grey cover**001** black base, yellow cover

... ..

Other combinations on request.

Housing dimensions**1** 72x80h56 mm**2** 120x80h56 mm**3** 153x80h56 mm**4** 186x80h56 mm**6** 252x80h56 mm

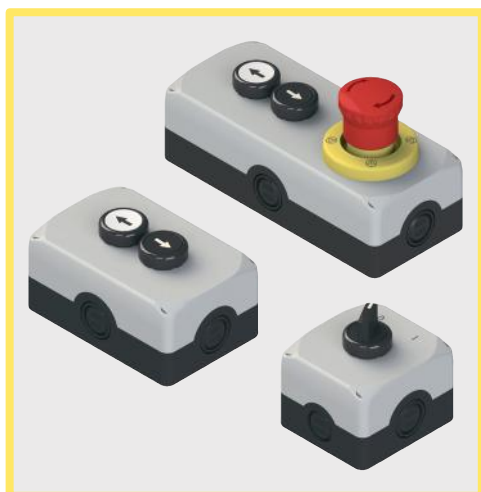

Main features

- Protection degrees IP67 and IP69K
- Stainless steel captive screws
- 4 side cable entries
- Screw caps included in the scope of supply

Quality marks:



EAC approval: RU C-IT.AQ35.B.00454

Technical data

Housing

Material:

Self-extinguishing shock-proof polycarbonate with double insulation, UV-resistant and glass fibre reinforced, high shock resistance.

Material of the screws:

Stainless steel

Protection degree:

IP67 acc. to EN 60529

IP69K acc. to ISO 20653 (cable gland of equal or higher protection degree)

Conduit entries:

Housing (1 hole):

4x knock-out side entries:

2x M20 - 1/2 NPT, 2x M20 - 1/2 NPT - M25

2x M16 knock-out base entries

Housings with 2-3-4-6 holes:

4x knock-out side entries:

4x M20 - 1/2 NPT - M25

2x M20 knock-out base entries

Device installation:

Suitable for the installation of Ø 22 mm control and signalling devices.

Ø 22 mm hole acc. to EN 60947-5-1

Utilization requirements:

see page 149

General data

Ambient temperature:

-40°C ... +80°C

Tightening torque of the cover screws: 1 ... 1.4 Nm

In compliance with standards:

IEC 60947-1, IEC 60947-5-1, IEC 60204-1, EN 60947-1, EN 60947-5-1, EN 60204-1, EN 50581, UL 508, CSA 22-2 N.14.

Compliance with the requirements of:

Low Voltage Directive 2014/35/EU,
EMC Directive 2014/30/EU,
RoHS Directive 2011/65/EU.

General data

Protection degrees IP67 and IP69K

IP69K
IP67

These devices are designed to be used in the toughest environmental conditions and they pass the IP67 immersion test acc. to EN 60529. They can therefore be used in all environments where maximum protection degree of the housing is required. Due to

their special design, these devices are suitable for use in equipment subjected to cleaning with high pressure hot water jets. These devices meet the IP69K test requirements according to ISO 20653 (water jets with 100 bar and 80°C).

Fixing of EROUND housings

The housings of the EROUND line by Pizzato Elettrica have 4 additional holes on the cover. The holes enable wall fixing from the outside by means of insertion of the screws, without the need to open the cover to access the holes.

The wall fixing screws and the ones for closing the housing cover can be sealed with 4 caps (supplied with the housing). The caps not only give the housing a more pleasant look, but they also prevent the accumulation of dirt inside the recesses of the screws besides making tampering more difficult.

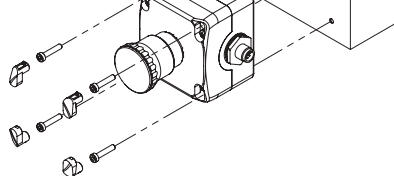

The external fixing of the housing is particularly valuable for already wired housings, since this simplifies the whole installation: you can simply fix the housing and connect the connector that, thanks to the presence of cable entries on the four sides of the housing, can be oriented in the preferred direction.

One housing, two solutions

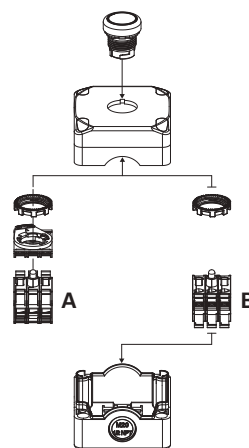

The housing can fit up to 3 contact blocks/LED units (E2 CP, E2 LP) for panel mounting by means of a mounting adapter (A) or up to 3 contact blocks/LED units (E2 CF, E2 LF) for base mounting directly on the bottom of the housing (B).

Wiring through the lower surface

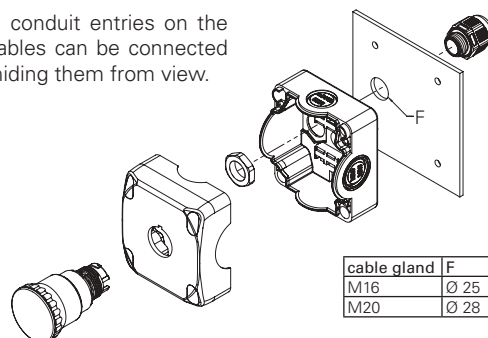

Housings have 2 conduit entries on the lower surface. Cables can be connected via this surface, hiding them from view.

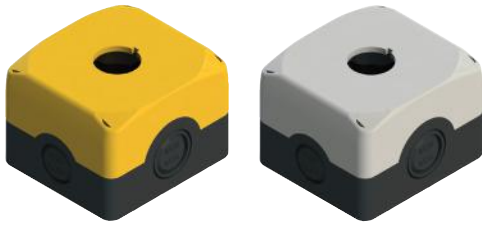

cable gland	F
M16	Ø 25
M20	Ø 28

Selection table for housings



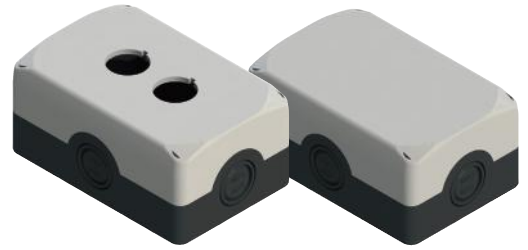

Cover colour	Article	Ø 22 mm hole
 yellow RAL 1003	ES 31001	1
 grey RAL 7035	ES 31000	1





Cover colour	Article	Ø 22 mm hole
 grey RAL 7035	ES 32000	2
 grey RAL 7035	ES 32002	0







Cover colour	Article	Ø 22 mm hole
 grey RAL 7035	ES 33000	3
 grey RAL 7035	ES 33002	0
 grey RAL 7035	ES 33003	2



Cover colour	Article	Ø 22 mm hole
 grey RAL 7035	ES 34000	4
 grey RAL 7035	ES 34002	0
 grey RAL 7035	ES 34003	3



Cover colour	Article	Ø 22 mm hole
 grey RAL 7035	ES 36000	6
 grey RAL 7035	ES 36002	0
 grey RAL 7035	ES 36003	5
 grey RAL 7035	ES 36012	5 equidistant

Note: Item ES 36012 compatible with panel-mounted contact blocks only.

Complete units with housings



Housing cover colour	Actuator colour and engraving	Contacts			Flush button black bezel	Projecting button black bezel
		pos. 2	pos. 3	pos. 1		
grey RAL 7035	green	-	1NO	-	ES AC31001 ES 31000 + E2 1PU2R421L2 + E2 CF10G2V1	-
grey RAL 7035	red	-	1NC	-	ES AC31002 ES 31000 + E2 1PU2R321L1 + E2 CF01G2V1	ES AC31017 ES 31000 + E2 1PU2S321L1 + E2 CF01G2V1
grey RAL 7035	green	-	1NO	-	ES AC31015 ES 31000 + E2 1PU2R421GB1 + E2 CF10G2V1	-
grey RAL 7035	red	-	1NC	-	ES AC31016 ES 31000 + E2 1PU2R321GB0 + E2 CF01G2V1	ES AC31018 ES 31000 + E2 1PU2S321GB0 + E2 CF01G2V1

Other combinations on request.

→ For data regarding contact blocks, please see the respective chapters.



Housing cover colour	Positions	Contacts			Black selector switch with 2 positions black bezel
		pos. 2	pos. 3	pos. 1	
grey RAL 7035	∨	-	1NO	-	ES AC31019 ES 31002 + E2 1SE12AVA11AB + E2 CF10G2V1

Housing cover colour	Positions	Contacts			Black key selector switch with 2 positions black bezel
		pos. 2	pos. 3	pos. 1	
grey RAL 7035	∨	-	1NO	-	ES AC31020 ES 31000 + E2 1SC2AVA11AE + E2 CF10G2V1

Other combinations on request.

→ For data regarding contact blocks, please see the respective chapters.

Other combinations on request.

Legend ∨ Maintained ∇ Spring-return ⌘ Key extraction position





Housing cover colour	Actuator design and colour	Contacts			Emergency stop button Push-Pull	Emergency stop button rotary release	Emergency stop button, key release
		pos. 2	pos. 3	pos. 1			
yellow RAL 1003	red	-	1NC	-	ES AC31004 ES 31001 + E2 1PEPZ4531 + E2 CF01G2V1	ES AC31003 ES 31001 + E2 1PERZ4531 + E2 CF01G2V1	ES AC31022 ES 31001 + E2 1PEBZ4531 + E2 CF01G2V1
yellow RAL 1003	red	-	1NC	-	ES AC31081 ES 31001 + E2 1PEPZ4531 + E2 CF01S2V1	ES AC31082 ES 31001 + E2 1PERZ4531 + E2 CF01S2V1	ES AC31083 ES 31001 + E2 1PEBZ4531 + E2 CF01S2V1
yellow RAL 1003	red	1NC	-	1NC	ES AC31009 ES 31001 + E2 1PEPZ4531 + E2 CF01G2V1 + E2 CF01G2V1	ES AC31005 ES 31001 + E2 1PERZ4531 + E2 CF01G2V1 + E2 CF01G2V1	ES AC31023 ES 31001 + E2 1PEBZ4531 + E2 CF01G2V1 + E2 CF01G2V1
yellow RAL 1003	red	1NC	-	1NO	ES AC31010 ES 31001 + E2 1PEPZ4531 + E2 CF01G2V1 + E2 CF10G2V1	ES AC31006 ES 31001 + E2 1PERZ4531 + E2 CF01G2V1 + E2 CF10G2V1	ES AC31011 ES 31001 + E2 1PEBZ4531 + E2 CF01G2V1 + E2 CF10G2V1
yellow RAL 1003	red	1NC	1NC	1NO	ES AC31146 ES 31001 + E2 1PEPZ4531 + E2 CF01G2V1 + E2 CF01G2V1 + E2 CF10G2V1	ES AC31021 ES 31001 + E2 1PERZ4531 + E2 CF01G2V1 + E2 CF10G2V1	ES AC31024 ES 31001 + E2 1PEBZ4531 + E2 CF01G2V1 + E2 CF01G2V1 + E2 CF10G2V1

Other combinations on request.

→ For data regarding contact blocks, please see the respective chapters.

Complete units with housings



















Housing cover colour	Actuator design and colour	Contacts			Emergency stop button Push-Pull Yellow luminous disc, blinking Ø 60 mm, 24 Vac/dc	Emergency stop button rotary release Yellow luminous disc, blinking Ø 60 mm, 24 Vac/dc	Emergency stop button, key release Yellow luminous disc, blinking Ø 60 mm, 24 Vac/dc
		pos. 2	pos. 3	pos. 1			
 grey RAL 7035	 red	1NO	1NC 	CONNECTION BLOCK	ES AC31430 ES 31000 + E2 1PEPZ4531 + VE DL1A5L13 + E2 CP10G2V1 + E2 CP01G2V1 + VE BC2PV1	ES AC31433 ES 31000 + E2 1PERZ4531 + VE DL1A5L13 + E2 CP10G2V1 + E2 CP01G2V1 + VE BC2PV1	ES AC31436 ES 31000 + E2 1PEBZ4531 + VE DL1A5L13 + E2 CP10G2V1 + E2 CP01G2V1 + VE BC2PV1
 grey RAL 7035	 red	1NO	1NC  SELF-MONITORED	CONNECTION BLOCK	ES AC31431 ES 31000 + E2 1PEPZ4531 + VE DL1A5L13 + E2 CP10G2V1 + E2 CP01S2V1 + VE BC2PV1	ES AC31434 ES 31000 + E2 1PERZ4531 + VE DL1A5L13 + E2 CP10G2V1 + E2 CP01S2V1 + VE BC2PV1	ES AC31437 ES 31000 + E2 1PEBZ4531 + VE DL1A5L13 + E2 CP10G2V1 + E2 CP01S2V1 + VE BC2PV1
 grey RAL 7035	 red	1NO	2NC 	CONNECTION BLOCK	ES AC31432 ES 31000 + E2 1PEPZ4531 + VE DL1A5L13 + E2 CP10G2V1 + E2 CP02G2V1 + VE BC2PV1	ES AC31435 ES 31000 + E2 1PERZ4531 + VE DL1A5L13 + E2 CP10G2V1 + E2 CP02G2V1 + VE BC2PV1	ES AC31438 ES 31000 + E2 1PEBZ4531 + VE DL1A5L13 + E2 CP10G2V1 + E2 CP02G2V1 + VE BC2PV1

Other combinations on request.
 → For data regarding contact blocks and luminous discs, please see the respective chapters.

Complete units with housings and wired M12 connector



Housing cover colour	Actuator design and colour	Contacts			Emergency stop button rotary release with plastic M12 connector
		pos. 2	pos. 3	pos. 1	
 yellow RAL 1003	 red	-	1NC 	-	ES AC31025
 yellow RAL 1003	 red	-	1NC  SELF-MONITORED	-	ES AC31084
 yellow RAL 1003	 red	1NC 	-	1NC 	ES AC31026
 yellow RAL 1003	 red	1NC 	-	1NO	ES AC31027
 yellow RAL 1003	 red	1NC 	1NC 	1NO	ES AC31028

Other combinations on request.
 Wiring diagram for assembled M12 connectors, see page 166.
 → For data regarding contact blocks, please see the respective chapters.

Spare caps

Article	Description
 VETS35RA1	4 spare caps for ES series housing cover. Colour: yellow
 VETS39RA1	4 spare caps for ES series housing cover. Colour: grey

Accessories

→ More ACCESSORIES on page 143

→ The 2D and 3D files are available at www.pizzato.com



ES AC32012

Description	Features	Diagram
Button - 1NO E2 1PU2R221L9 Contacts 1x E2 CF10G2V1	flush, spring-return, white pos. 2 / pos. 3 1NO pos. 1 /	
Button - 1NO E2 1PU2R121L10 Contacts 1x E2 CF10G2V1	flush, spring-return, black pos. 2 / pos. 3 1NO pos. 1 /	



ES AC32010

Description	Features	Diagram
Button - 1NO E2 1PU2R421L35 Contacts 1x E2 CF10G2V1	flush, spring-return, green pos. 2 / pos. 3 1NO pos. 1 /	
Button - 1NC E2 1PU2S321L1 Contacts 1x E2 CF01G2V1	projecting, spring-return, red pos. 2 / pos. 3 1NC ⊕ pos. 1 /	



ES AC33017

Description	Features	Diagram
Button - 1NO E2 1PU2R221L9 Contacts 1x E2 CF10G2V1	flush, spring-return, white pos. 2 / pos. 3 1NO pos. 1 /	
Button - 1NC E2 1PU2S321L1 Contacts 1x E2 CF01G2V1	projecting, spring-return, red pos. 2 / pos. 3 1NC ⊕ pos. 1 /	
Button - 1NO E2 1PU2R121L10 Contacts 1x E2 CF10G2V1	flush, spring-return, black pos. 2 / pos. 3 1NO pos. 1 /	



ES AC4035

Description	Features	Diagram
Button - 1NO E2 1PU2R221L9 Contacts 1x E2 CP10G2V1	flush, spring-return, white pos. 2 / pos. 3 1NO pos. 1 /	
Button - 1NO E2 1PU2R121L10 Contacts 1x E2 CP01G2V1	flush, spring-return, black pos. 2 / pos. 3 1NO pos. 1 /	
Emergency stop button E2 1PERZ4531 Contacts 1x E2 CP01G2V1+1x E2 CP10G2V1	rotary release, red pos. 2 1 NO pos. 3 / pos. 1 1NC ⊕	
Luminous disc VE DL1A6L13	Yellow, continuous light 24 Vac/dc	



ES AC36041

Description	Features	Diagram
Button - 1NO E2 1PU2F4410 Protection guard 1x VE GP32B1A Contacts 1x E2 CP10G2V1	mushroom, spring-return, green cylindrical, black pos. 2 / pos. 3 1NO pos. 1 /	
Emergency stop button - 1NC E2 1PERZ4531 Contacts 1x E2 CP01G2V1	rotary release, red pos. 2 / pos. 3 1NC ⊕ pos. 1 /	
Button - 1NO E2 1PU2F4410 Protection guard 1x VE GP32B1A Contacts 1x E2 CP10G2V1	mushroom, spring-return, green cylindrical, black pos. 2 / pos. 3 1NO pos. 1 /	

Other combinations on request.

Dimensions

All values in the drawings are in mm

Housings (72 x 80 h 56)

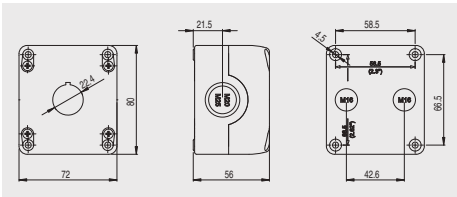

Housings (120 x 80 h 56)

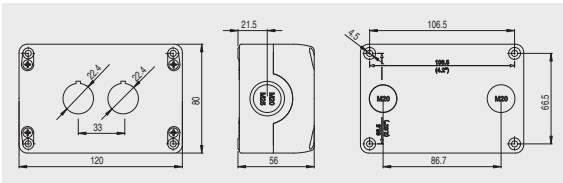

Housings (153 x 80 h 56)

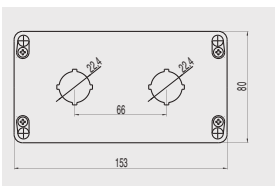
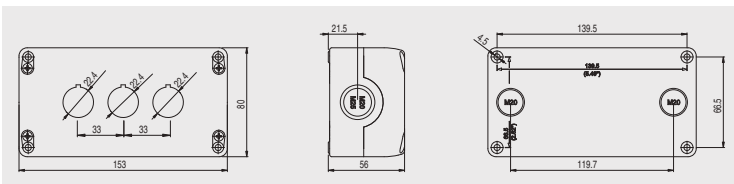

Housings (186 x 80 h 56)

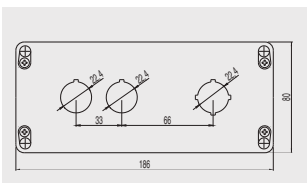
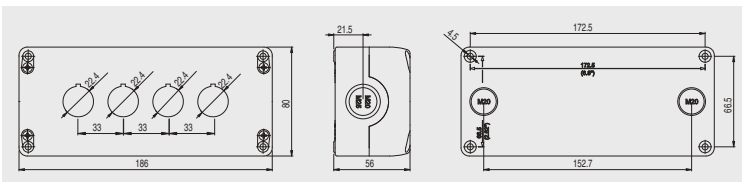

Housings (252 x 80 h 56)

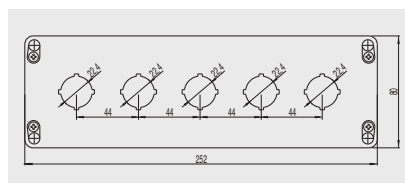
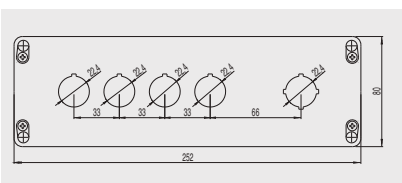
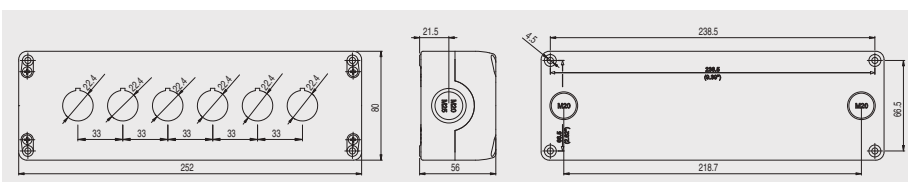

→ The 2D and 3D files are available at www.pizzato.com