

Selection diagram

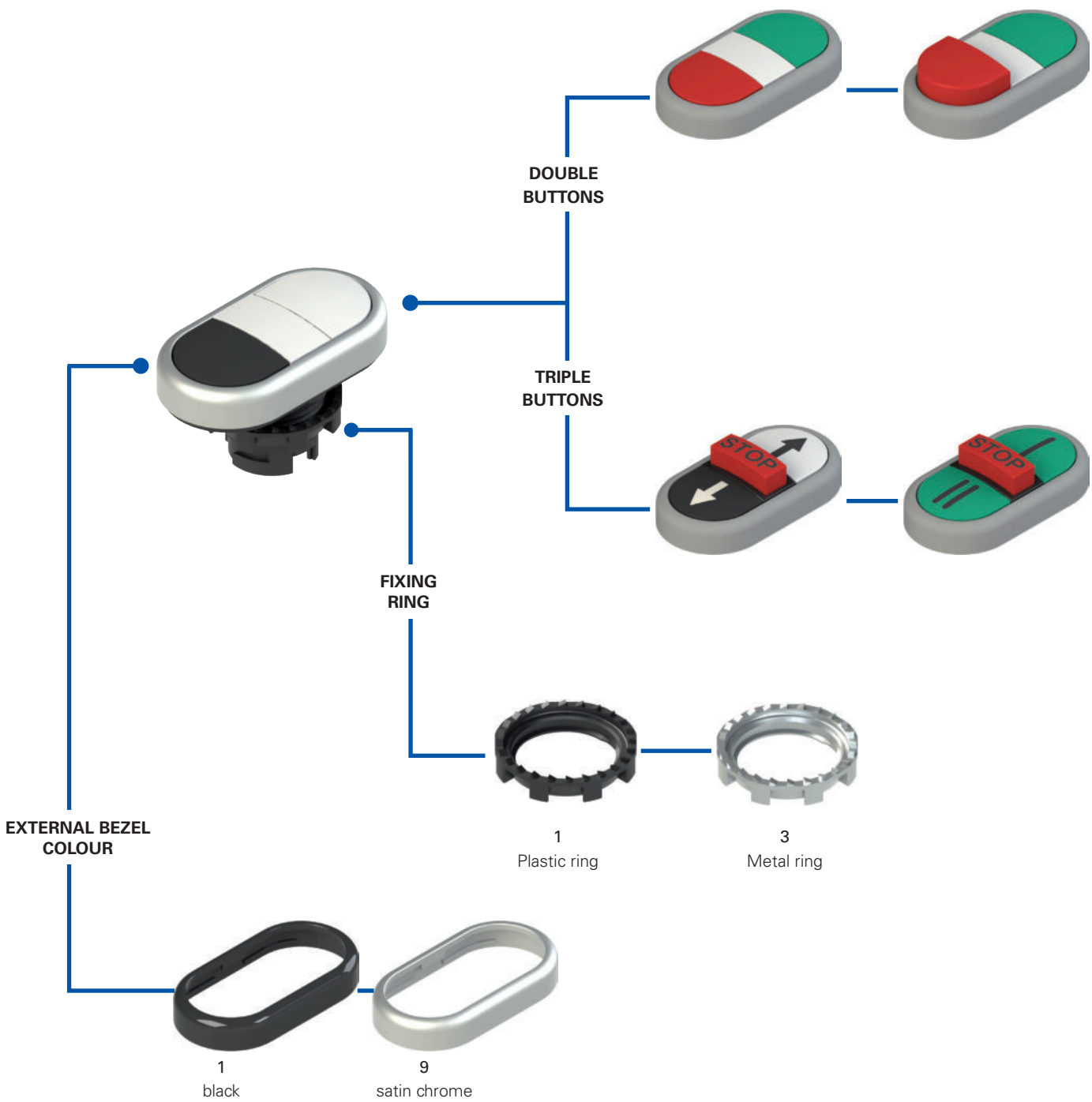

Code structure **Attention!** The feasibility of a code number does not mean the effective availability of a product. Please contact our sales office.

article options
E2 1PDRL10423-T6

Fixing ring and shaped ring	
1	Plastic ring (standard)
2	Plastic fixing ring and shaped ring
3	Metal ring
4	Metal fixing ring and shaped ring

Ambient temperature	
	-25°C ... +80°C (standard)
T6	-40°C ... +80°C

No. of functions	
D	Double button
T	triple button

Upper and lower button	
A	upper projecting, lower flush
B	upper projecting, lower projecting
R	upper flush, lower flush
S	upper flush, lower projecting

Intermediate element	
L	backlit cap (only double buttons)
S	projecting button (triple buttons only)
Q	cap and actuators for 4-slot base (double buttons only)

Bezel colour	
1	black (standard)
9	satin chrome (standard)

	upper button		central cap		lower button	
	colour	symbol	colour	symbol	colour	symbol
0423	green	-	white	-	red	-
0221	white	-	white	-	black	-
0222	white	-	white	-	white	-
0121	black	-	white	-	black	-

Other combinations on request.

	upper button		central cap		lower button	
	colour	symbol	colour	symbol	colour	symbol
AAAD	green	I	white	-	red	O
AAAP	green	START	white	-	red	STOP
AAAA	white	I	white	-	black	O
AAAN	white	START	white	-	black	STOP
AAAB	black	↑	white	-	black	↓
AAAC	black	+	white	-	black	-

Other combinations on request.

	upper button		central button projecting		lower button	
	colour	symbol	colour	symbol	colour	symbol
AAAY	green	I	red	STOP	green	II
AAAZ	green	←	red	STOP	green	→
AABD	white	→	red	STOP	black	←
AABA	green	↑	red	STOP	green	↓
AABE	white	↑	red	STOP	black	↓
AABF	black	↑	red	STOP	black	↓
AABB	green	+	red	STOP	green	-
AABC	white	+	red	STOP	white	-

Other combinations on request.



Main features

- Protection degrees IP67 and IP69K
- Version with 2 or 3 buttons
- - 40°C version
- Version with central backlit cap

Quality marks:



IMQ approval: CA02.04805
 UL approval: E131787
 EAC approval: RU C-IT.YT03.B.00035/19

General data

Protection degree:	IP67 acc. to EN 60529 IP69K acc. to ISO 20653
Ambient temperature:	-25°C ... +80°C (standard) -40°C ... +80°C (T6 option)
Safety parameter B_{10D} :	2,000,000
Mechanical endurance:	1 million operating cycles
Max. actuation frequency:	3600 operating cycles/hour
Actuating force at limit of travel:	4.4 N (without contacts)
Maximum travel:	5 mm
Tightening torque of the fixing ring:	2 ... 2.5 Nm
Utilization requirements:	see page 149

In compliance with standards:

IEC 60947-1, IEC 60947-5-1, IEC 60204-1, EN 60947-1, EN 60947-5-1, EN 60204-1, EN 50581, UL 508, CSA 22-2 n°14

⚠ Installation for safety applications:

Use only contact blocks marked with the symbol ⊕. The safety circuit must always be connected to **NC contacts** (normally closed contacts: .1-2).

Compliance with the requirements of:

Low Voltage Directive 2014/35/EU,
 EMC Directive 2014/30/EU,
 RoHS Directive 2011/65/EU.

Positive contact opening in conformity with standards:

IEC 60947-5-1, EN 60947-5-1.

Features approved by UL

For Use on a Flat Surface of a Type 1, 4X, 12 and 13
 Tightening torque 2.0 Nm

General data

Button profile

In order to be used in different types of application, the EROUND line double and triple buttons are now available in two shapes: projecting and flush. The possible choice of shapes, colours and symbols allows various code combinations for buttons.

Illuminated version

For double buttons, the version with central backlit cap is available.

Metal fixing ring



The fixing ring in metal is particularly suitable for those applications which require tighter fitting of the panel-mounted device, such as for example in metal panels having holes without reference notches.

Shaped ring

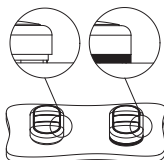

The shaped ring can be used when no label holder or other devices are applied; it prevents dirt and other residues from settling between the button and the panel or housing.

This turns out to be particularly useful in the sectors where high standards of cleanness and hygiene are required.

Customisable



In order to satisfy various customer requests and demands, Pizzato Elettrica offers the possibility to customize the control and signalling devices of the EROUND line: the bezels can be requested with different colours (black and satin chrome), whereas the lenses can be customized with a wide range of writings, symbols, and colours.

Protection degrees IP67 and IP69K

IP69K
IP67

These devices are designed to be used in the toughest environmental conditions and they pass the IP67 immersion test acc. to EN 60529. They can therefore be used in all environments where maximum protection degree of the housing is required. Due to their special design, these devices are suitable for use in equipment subjected to cleaning with high pressure hot water jets. These devices meet the IP69K test requirements according to ISO 20653 (water jets with 100 bar and 80°C).

Extended temperature range







-40°C

These devices are also available in a special version suitable for an ambient operating temperature range from -40°C up to +80°C.

They can therefore be used for applications in cold stores, sterilisers and other equipment with low temperature environments. The special materials used to produce these versions retain their characteristics even under these conditions, thereby expanding the installation possibilities.

Selection table for double buttons











Actuator colour and engraving	upper button flush central cap, flush lower button flush		upper button flush central cap, flush lower button projecting	
	black bezel	Satin chrome bezel	black bezel	Satin chrome bezel
 green button white cap, illuminated red button "I"	E2 1PDRL10423	E2 1PDRL90423	E2 1PDSL10423	E2 1PDSL90423
 green button white cap, illuminated "O" red button "START"	E2 1PDRL1AAAD	E2 1PDRL9AAAD	E2 1PDSL1AAAD	E2 1PDSL9AAAD
 green button white cap, illuminated "STOP" red button white button	E2 1PDRL1AAAP	E2 1PDRL9AAAP	E2 1PDSL1AAAP	E2 1PDSL9AAAP
 white button white cap, illuminated black button "I"	E2 1PDRL10221	E2 1PDRL90221	E2 1PDSL10221	E2 1PDSL90221
 white button white cap, illuminated "O" black button "START"	E2 1PDRL1AAAA	E2 1PDRL9AAAA	E2 1PDSL1AAAA	E2 1PDSL9AAAA
 white button white cap, illuminated "STOP" black button ↑	E2 1PDRL1AAAN	E2 1PDRL9AAAN	E2 1PDSL1AAAN	E2 1PDSL9AAAN
 black button white cap, illuminated "STOP" ↑ black button ↓	E2 1PDRL1AAAB	E2 1PDRL9AAAB	E2 1PDSL1AAAB	E2 1PDSL9AAAB

Other combinations on request.

Selection table for triple buttons



Actuator colour and engraving	upper button flush central button projecting lower button flush		Actuator colour and engraving	upper button flush central button projecting lower button flush	
	black bezel	Satin chrome bezel		black bezel	Satin chrome bezel
 "I" green button "STOP" red button "II"	E2 1PTRS1AAAY	E2 1PTRS9AAAY	 ↑ white button "STOP" red button ↓	E2 1PTRS1AABE	E2 1PTRS9AABE
 green button ← green button "STOP" red button →	E2 1PTRS1AAAZ	E2 1PTRS9AAAZ	 black button ↑ black button "STOP" red button ↓	E2 1PTRS1AABF	E2 1PTRS9AABF
 green button → white button "STOP" red button ←	E2 1PTRS1AABD	E2 1PTRS9AABD	 black button ↑ green button "STOP" red button ↓	E2 1PTRS1AABB	E2 1PTRS9AABB
 black button ↑ green button "STOP" red button ↓	E2 1PTRS1AABA	E2 1PTRS9AABA	 ↑ white button "STOP" red button ↓	E2 1PTRS1AABC	E2 1PTRS9AABC

Other combinations on request.

Other combinations on request.

Complete units with double buttons



Actuator colour and engraving		Contacts			upper button flush central cap, flush lower button projecting black bezel
		pos. 2	pos. 3	pos. 1	
	"I" green button	1NC ⊕	-	1NO	E2 AC-DXBC0625 E2 1PDSL1AAAD + E2 1BAC11 + E2 CP01G2V1 + E2 CP10G2V1
	white cap, illuminated				
	"O" red button				

Other combinations on request.

Complete units with triple buttons



Actuator colour and engraving		Contacts			upper button flush central button projecting lower button flush black bezel
		pos. 2	pos. 3	pos. 1	
	"I" green button	1NO	1NC ⊕	1NO	E2 AC-DXBC0801 E2 1PTRS1AAAY + E2 1BAC11 + E2 CP10G2V1 + E2 CP01G2V1 + E2 CP10G2V1
	"STOP" red button				
	"II" green button				

Other combinations on request.



Actuator colour and engraving		Contacts			upper button flush central cap, flush lower button projecting black bezel
		pos. 2	pos. 3	pos. 1	
	"I" green button	1NC ⊕	LED	1NO	E2 AC-DXBC0602 E2 1PDSL1AAAD + E2 1BAC11 + E2 CP01G2V1 + E2 LP1A2V1 + E2 CP10G2V1
	white cap, illuminated				
	"O" red button				

Other combinations on request.

→ For data regarding contact blocks and LED units, please see the respective chapters.

Protection cap

Packs of 10 pcs.

	Article	Description
	VE CA1C1	Protection cap for double and triple projecting buttons
	VE CA1D1	Protection cap for double flush button

With the protection cap it is not possible to apply the shaped ring

Shaped ring

Packs of 50 pcs.

	Article	Description
	VE GP12L1A	Shaped ring for double and triple button E2 •PD•••••••• E2 •PT••••••••

With the shaped ring it is not possible to apply the protection cap

Accessories

→ More ACCESSORIES on page 143

Dimensions

All values in the drawings are in mm

Flush double button

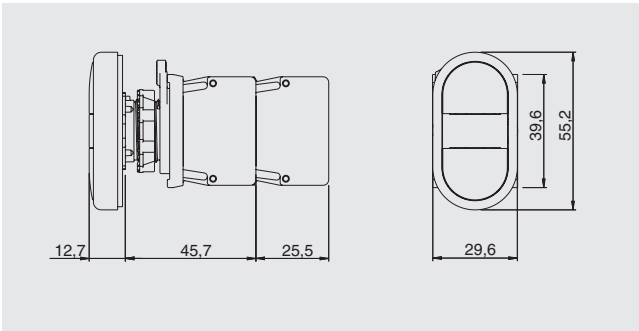

Projecting double button

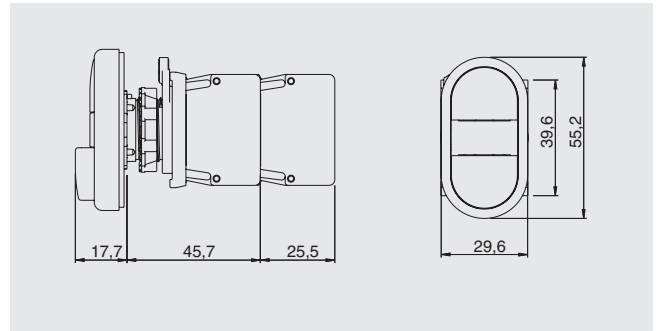

Triple button

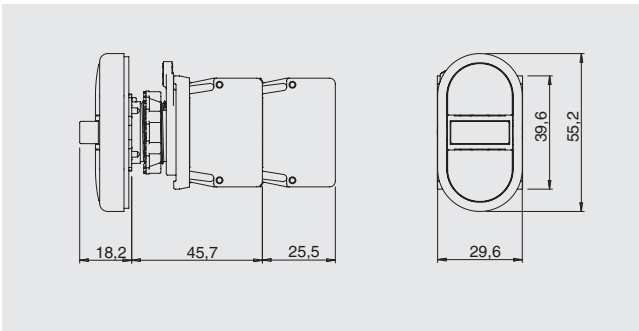

Minimum distances for installation

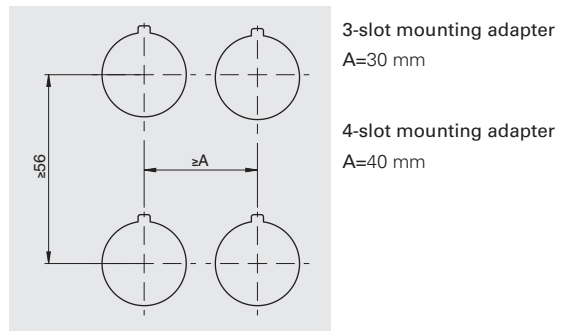

→ The 2D and 3D files are available at www.pizzato.com

Maximum number of contact blocks

3-slot mounting adapter

4-slot mounting adapter

Double buttons E2 •PD••••••••

Triple buttons E2 •PT••••••••

Double buttons E2 •PD•Q••••••

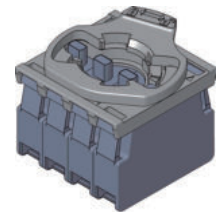
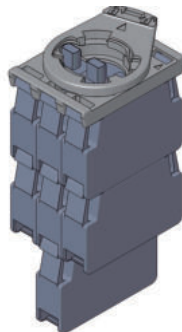
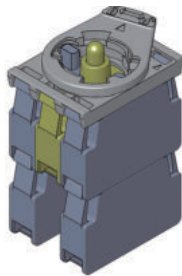

maximum number:
4 contact blocks
2 levels

maximum number:
7 contact blocks
3 levels

maximum number:
4 contact blocks
1 level

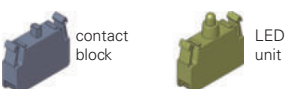
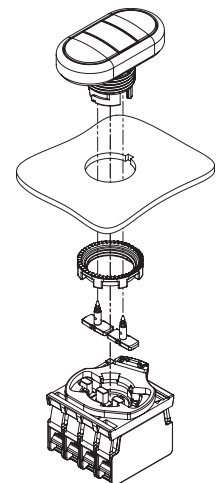
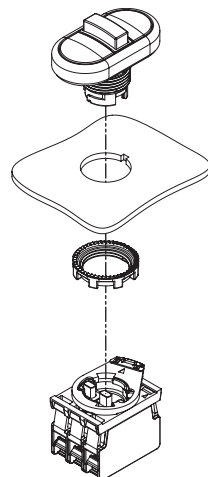

The actuators, with the specific button for 4-slot base, can be mounted only after fixing the button.