

COGNEX

Advanced machine vision made easy

All-purpose barcode reader powered by AI

DataMan 290 Series



Unmatched reliability and ease of use for every barcode reading challenge

DataMan 290 Series

Read any code, in any condition

Embedded AI, industry-proven decoding algorithms, and powerful lighting work together to deliver high read rates and optimize performance.

Simply unbox and deploy

Guided setup, AI tuning, and real-time feedback ensure successful scanning from the start.

Dedicated support at every step

Get the most out of your DataMan® 290 with end-to-end support, from training and deployment to ongoing management and optimization.



Key features

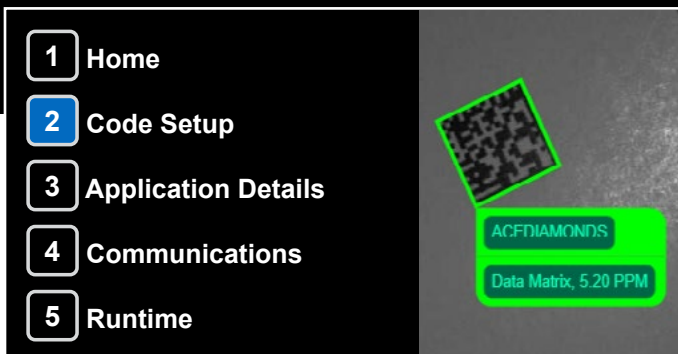

Web UI with guided setup

Follow guided setup to save time and reduce errors.



AI-enabled tuning

Get successful reads in a single click to minimize downtime.



AI-enhanced decoding

Read all code types, including damaged or low-quality codes, for guaranteed results.

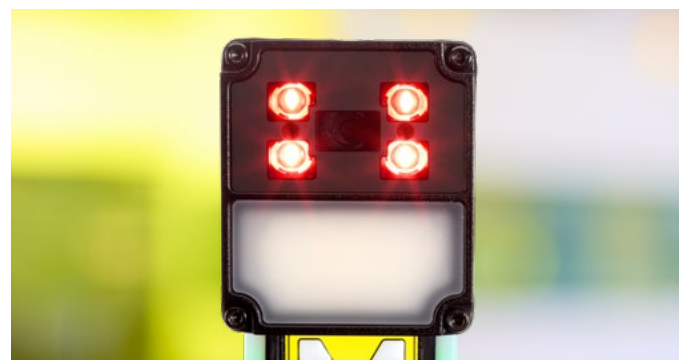

Fully integrated, all-in-one light

Illuminate every code, even in the hardest-to-see environments, for more reliable scanning.

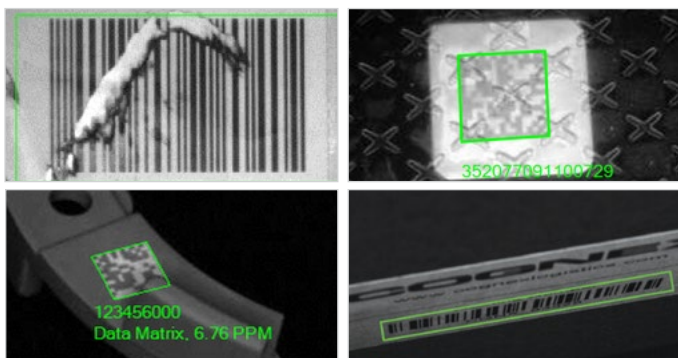

Proprietary image-based code reading technology

Achieve industry-leading read rates for all code types, maximizing efficiency and throughput.

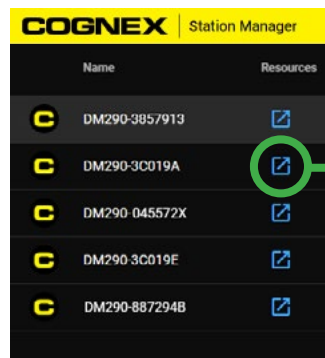

DataMan 290 Getting Started Resources



Built-in support gateway

Simplify setup with self-service support, directly accessible from the interface where you configure your device.

Application examples

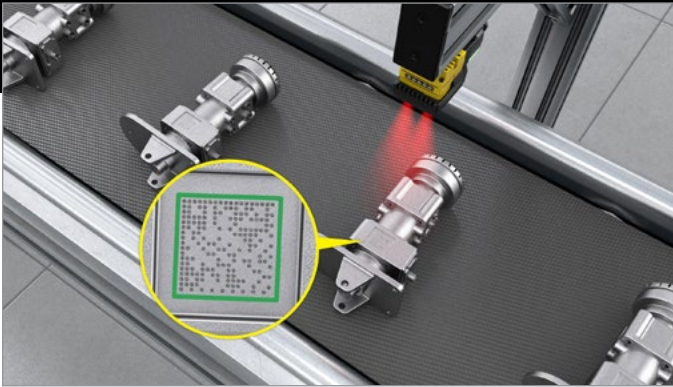

Automotive

Decode on reflective surfaces with accuracy, ease, and speed.

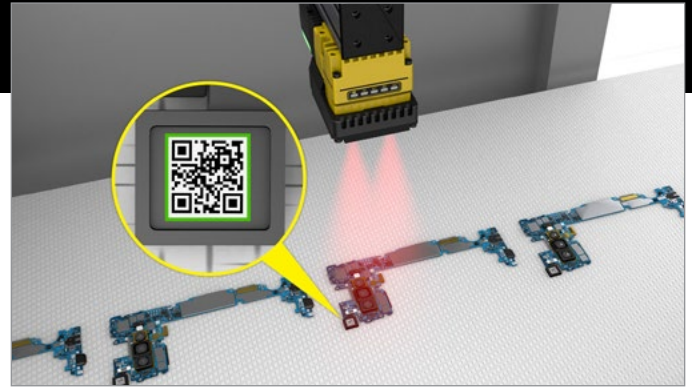

Electronics

Read barcodes on printed circuit boards (PCBs) for accurate tracking and traceability.

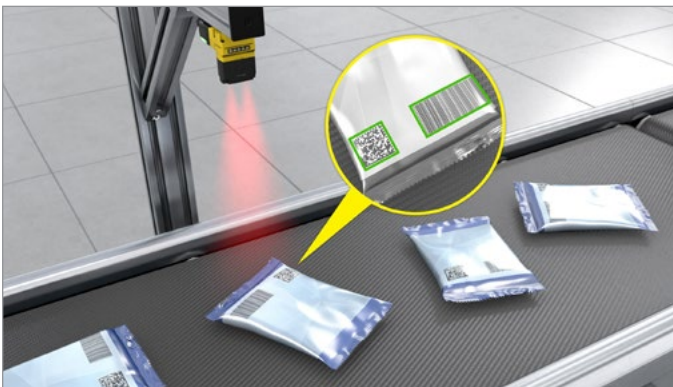

Consumer goods

Read multiple codes at the same time for fast and efficient track and trace operations.



Electric vehicle

Easily decode direct part marks (DPMs) on EV batteries.



Food and beverage

Reliably read barcodes at fast line speeds.

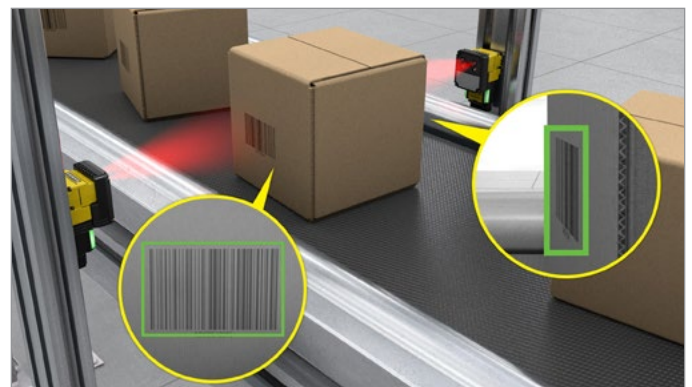

Logistics and warehouse operations

Accurately locate and read codes, even when placement is inconsistent or unpredictable.

Optimize your read rates with AI at every step

Find, enhance, and read barcodes with unmatched ease and accuracy.

1 Find

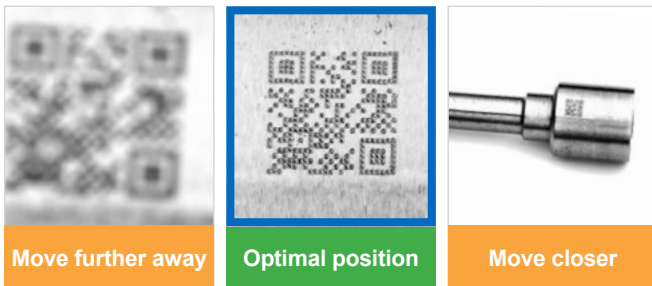

AI-guided positioning

Real-time positioning feedback ensures the code is at the optimal distance from the reader, maximizing accuracy and improving read rates.

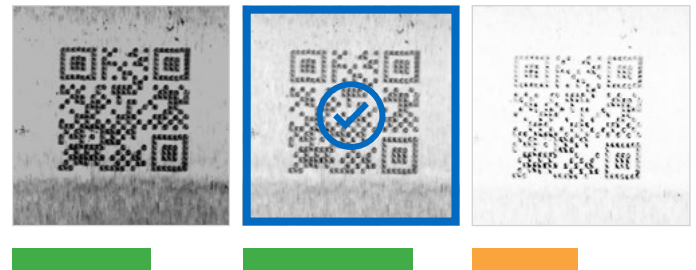

AI-enabled tuning

Find the right settings with automated tuning for easy setup and quickly locate barcodes for faster processing.

2 Enhance

AI-enhanced decoding

Increase image quality and detect clocking patterns in damaged or low-quality codes for more reliable code reading.

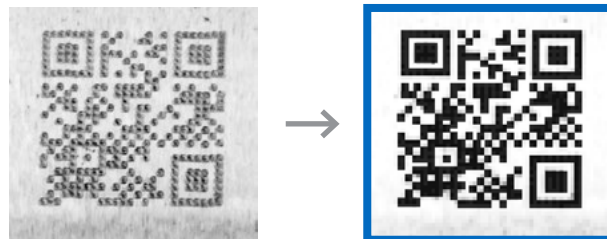

3 Read

AI-powered analysis

Read all code types, including occluded, distorted, or challenging codes with industry-proven decoding algorithms.



Go from unboxing to scanning in minutes with fast, simple setup

Web-based UI with guided workflow makes it easy

- 1** Find the device and open the home screen.
- 2** Adjust positioning and image acquisition with one-click tuning.
- 3** Set up trigger settings and data formatting.
- 4** Configure IO industrial communications.
- 5** Enter runtime monitoring view.

The screenshot displays the Cognex web-based UI. The top navigation bar includes the Cognex logo and five tabs: 1 Home, 2 Code Setup, 3 Application Details, 4 Communications, and 5 Runtime. The 'Code Setup' tab is selected. On the left, a sidebar lists steps: 1 Positioning, 2 Tuning, 3 Test, and 4 Review. The main area shows a video feed of a sensor with a QR code highlighted by a green box. The right sidebar contains 'Positioning' instructions, an 'Enable Aimer' toggle, a 'START LIVE MODE' button, and a 'Code not found?' status. The bottom of the screen shows 'Inputs' and 'Outputs' indicators, a 'Full' resolution dropdown, 'JPEG' format, and a 'TUNING >' button.

Support for advanced use cases and existing installations

For specialized applications, use the DataMan Setup Tool to customize the solution to your specific needs.

For existing users, maintain continuity with your current setup.



Handle a range of industrial barcode reading requirements

Unified design offers flexible performance

Fully integrated, all-in-one light

Illuminate every code, even in the hardest-to-see environments

Get three lights in one:



Direct

Polarized

Diffuse

Compact form factor

Multi and Mini Light options



1.6 MP sensor

Indicator lights for operator feedback

Neural processing unit enables AI acceleration

Powered by 24V

Multiple communication options for fast, easy integration with the factory floor

PowerGrid™ technology reads damaged or incomplete codes for more reliable scanning



2016600010
Data Matrix.

Empowering your success with end-to-end customer support

Cognex Customer Success

From personalized setup and training to expand your capabilities to continual learning and performance optimization, Cognex guides you at every step of your automation journey.

With Cognex Customer Success, you can focus on what matters most – delivering quality, innovation, and efficiency in your manufacturing process.

- **Plan & Deploy**
- **Run & Support**
- **Expand & Optimize**



Plan & Deploy

- **Targeted guidance** to choose the right products and validate your deployment
- **Tuning and positioning guidance** built in
- **Curated documentation and videos** for configuration and setup
- **Single-click registration** to access more customized support



Watch DataMan 290 tutorials:
cognex.com/dataman-290-support



Run & Support

- **Connected tech support** flows seamlessly across email, text, WhatsApp, phone, and chat
- **Expert help and guidance** via visual remote assistant and easy online scheduling
- **Self-service training** to take you from beginner to expert, in multiple languages
- **Cognex support community** provides answers, real-time status updates, and transparent case tracking
- **Reliable, resilient products** made to stay running consistently, tolerate harsh environments, and be easy to adjust if needed

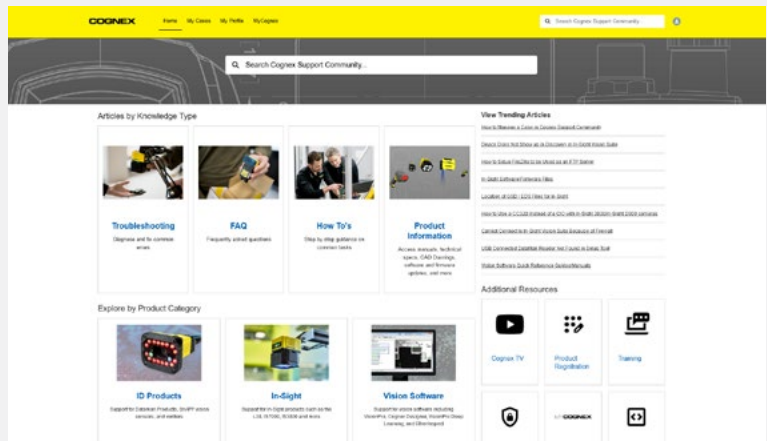

Cognex Support Community
community.cognex.com/support



Expand & Optimize

- **Broad portfolio of products** with common tools and software, plus easy upgrade paths
- **Pre-built dashboards** that help you find performance insights across your entire operation
- **Management tools** to control settings across devices, lines, and plants
- **Out-of-the-box data sharing** makes it easy to connect to enterprise systems
- **Coaching from experts** with decades of experience to help you grow quickly and smoothly

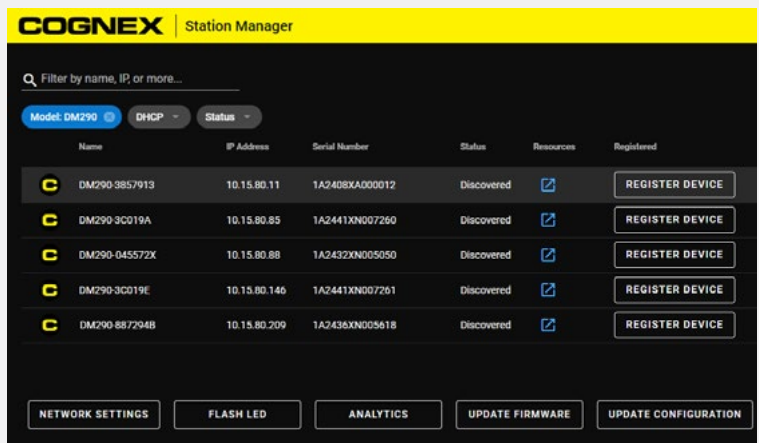

Station Manager

Connect and manage multiple devices, set up your application, and enhance your performance with direct access to support resources.

Specifications

DataMan 290

Image Sensor	1/3-inch CMOS, global shutter
Image Sensor Properties	Diagonal size: 6.21 mm Pixel size: 3.45 µm (H)
Image Resolution	1440 x 1080 pixels
Lens Options	6.2 mm or 16 mm High Speed Liquid Lens
Electronic Shutter Speed	Minimum exposure: 43 µs Maximum exposure: 200 ms (with external illumination)
Acquisition	Up to 45 Hz
Lighting	Multi-Purpose Integrated Light: 4 LED lights (red), and 1 Diffused light (white) for 6.2 mm and 16 mm lens Front cover options: (2) polarized, (2) direct and diffuse. Mini Light: 4 LED high-powered lights (red) for 6.2 mm and 16 mm lens Front cover options: polarized, half-polarized and clear.
Status Outputs	5 status LEDs, audible beeper, 2 visual indicator lights
Discrete Inputs	2 opto-isolated, 2 configurable
Discrete Outputs	2 opto-isolated, 2 configurable
Power	24 V DC +/- 10% ¹
Power Consumption	≤ 7.5 W
Weight	Multi-Purpose Integrated Light 6.2 mm Model: 214 g Multi-Purpose Integrated Light 16 mm Model: 234 g Mini Light 6.2 mm Model: 194 g Mini Light 16 mm Model: 169 g
Sensor Temperature	0-70 °C (32-158 °F) ²
Storage Temperature	-10-60 °C (14-140 °F)
Operating and Storage Humidity	<95% non-condensing
Shock	IEC 60068-2-27: 1000 shocks, semi-sinusoidal, 11 g, 10 ms ISTA-1A Standardized Testing - Packaged Products 150 lb or less
Vibration	IEC 60068-2-6: vibration test in each of the three main axis for 2 hours @ 10 Gs (10 to 500 Hz at 100m/s ² / 15 mm) FedEx Vibration Testing for packaged products 150 lbs or less
Environmental	Altitude: 2000 m, indoor use only, pollution degree II
Communications	Serial, Ethernet, USB-C ³ , and keyboard compatibility
Ethernet	10/100 BASE-T. Full duplex or half duplex. IEEE802.3
RS-232	RxD, TxD according to TIA/EIA-232-F
Protocols	TCP/IP, PROFINET (class B), EtherNet/IP™, SLMP, CC-Link, Modbus TCP, NTP, SFTP, FTP, MRS, (Java Scripting enabled for custom protocols)
Protection	IP67
RoHS Certified	Yes
Approvals	EU [CE], CB, NRTL, IEC 61010, Korea [KCC], TÜV, India [BIS]

¹ To comply with CSA No.61010-1/UL61010-1/IEC61010-1, use a power supply that provides Class 2 output as defined in the CEC and NEC OR has been evaluated as a Limited Power Source as defined in CAN/CSA-C22.2 No.60950-1/UL60950-1/IEC60950-1.

² To verify sensor temperature, use the temperature readout in the Web UI. Additional cooling measures are required if the sensor temperature cannot be kept below 70 °C. Examples of such measures include mounting the reader to a heat sink, reducing ambient temperature, and ensuring there is air flow over the reader.

³ The reader should not be powered by USB-C alone.

Field of view diagrams¹

Working distances
Units: mm (in)

6.2 mm lens

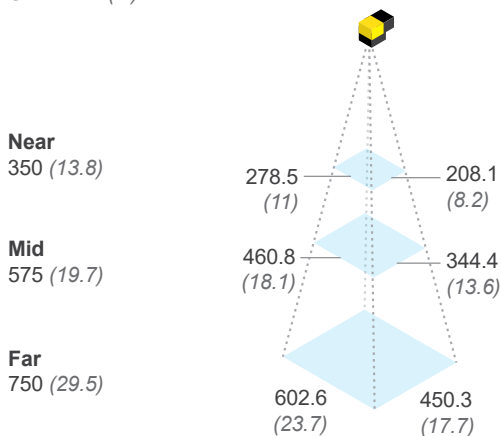

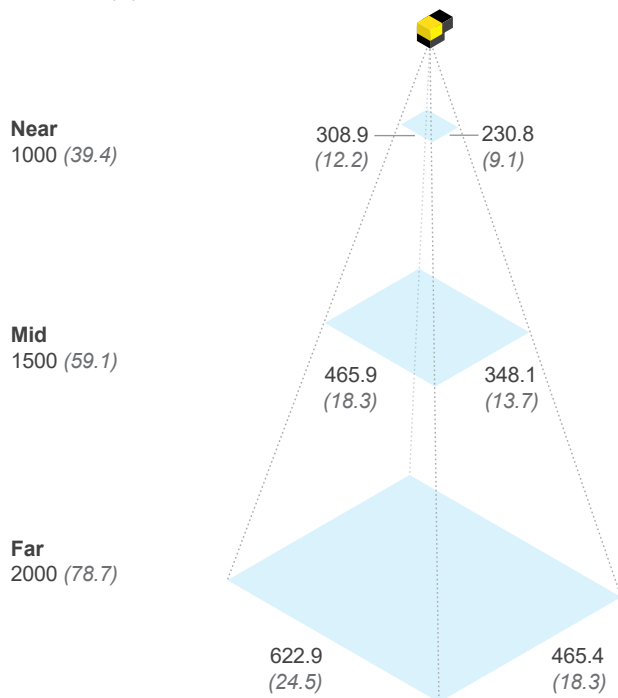

Working distances
Units: mm (in)

16 mm lens





Product IDs and Descriptions²



DataMan 290						
	Product ID including 5 m cables and bracket	Product ID, system only	Resolution	Light	Lens	Cover
	DM290X-16-LM-05	DM290X-16-LM	1.6MP	Multi-Purpose Integrated Light	16 mm HSSL	—
	DM290X-06-LM-05	DM290X-06-LM	1.6MP	Multi-Purpose Integrated Light	6.2 mm HSSL	—
	DM290X-16-SP-05	DM290X-16-SP	1.6MP	Mini Light	16 mm HSSL	Half Polarized
	DM290X-06-SC-05	DM290X-06-SC	1.6MP	Mini Light	6.2 mm HSSL	Clear



¹ These values are not exact minimum and maximum working distances, which are dependent on code size. Please see the DataMan 290 Reference Manual for more information.

² This table includes only the most common product models. To get information on other available models, please contact Cognex Sales at cognex.com/contact-sales.

Components and accessories

Power and I/O			
	Product ID	Length	Description
	CCB-PWRIO-05	5M	M12-12 to flying lead, straight
	CCB-PWRIO-10	10M	
	CCB-PWRIO-15	15M	
	CCB-PWRIO-05R	5M	M12-12 to flying lead, right-angled
	CCB-PWRIO-10R	10M	
CCB-PWRIO-15R	15M		
	CCB-CIO-40517-100	1M	Right Angle Shielded Secondary Cable
	CCB-CIO-40517-200	2M	
	DMA-CCM-1-US		Single cam I/O box

Ethernet Cables			
	Product ID	Length	Description
	CCB-84901-2001-02	2M	X-coded M12-8 to RJ-45, straight
	CCB-84901-2001-05	5M	
	CCB-84901-2001-10	10M	
	CCB-84901-2001-15	15M	
	CCB-84901-2001-30	30M	
	CCB-84901-2002-02	2M	X-coded M12-8 to RJ-45, right-angled
	CCB-84901-2002-05	5M	
	CCB-84901-2002-10	10M	
	CCB-84901-2RBT-02	2M	Robotic X-coded M12-8 to RJ-45, straight
CCB-84901-2RBT-05	5M		
CCB-84901-2RBT-10	10M		
	CCB-M12X8MS-XCAC	0.5M	X-coded to A-coded Ethernet cable adapter
	CCB-CIO-51016-100	1M	Right Angle Ethernet Chain Cable
	CCB-CIO-51016-200	2M	

Mounting Brackets		
	Product ID	Description
	DM290-UBRK-01	DM290 universal mounting bracket
	DM100-PIVOTM-01	Pivot mounting bracket

Cognex: Your Single Supplier for All Barcode Reading Applications

Need to read smaller codes or scan a wider area? Check out the DataMan 390.



With the same user interface, transitioning to this reader is easy for applications that require higher resolution, multi-code reading, or a larger field of view.

cognex.com/dataman390



Dimensions

DataMan 290 with Multi-Purpose Integrated Light and 6.2 mm Lens

[Download CAD files](#)

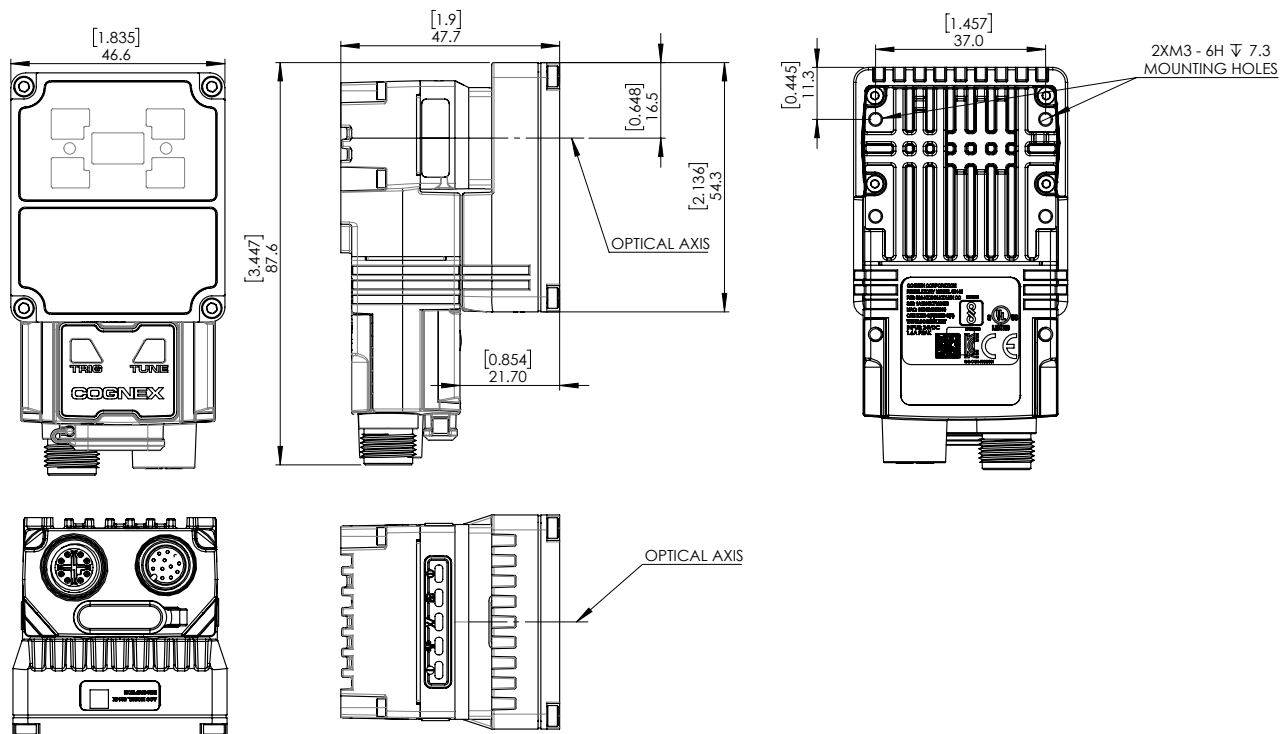

DataMan 290 with Multi-Purpose Integrated Light and 16 mm Lens

[Download CAD files](#)

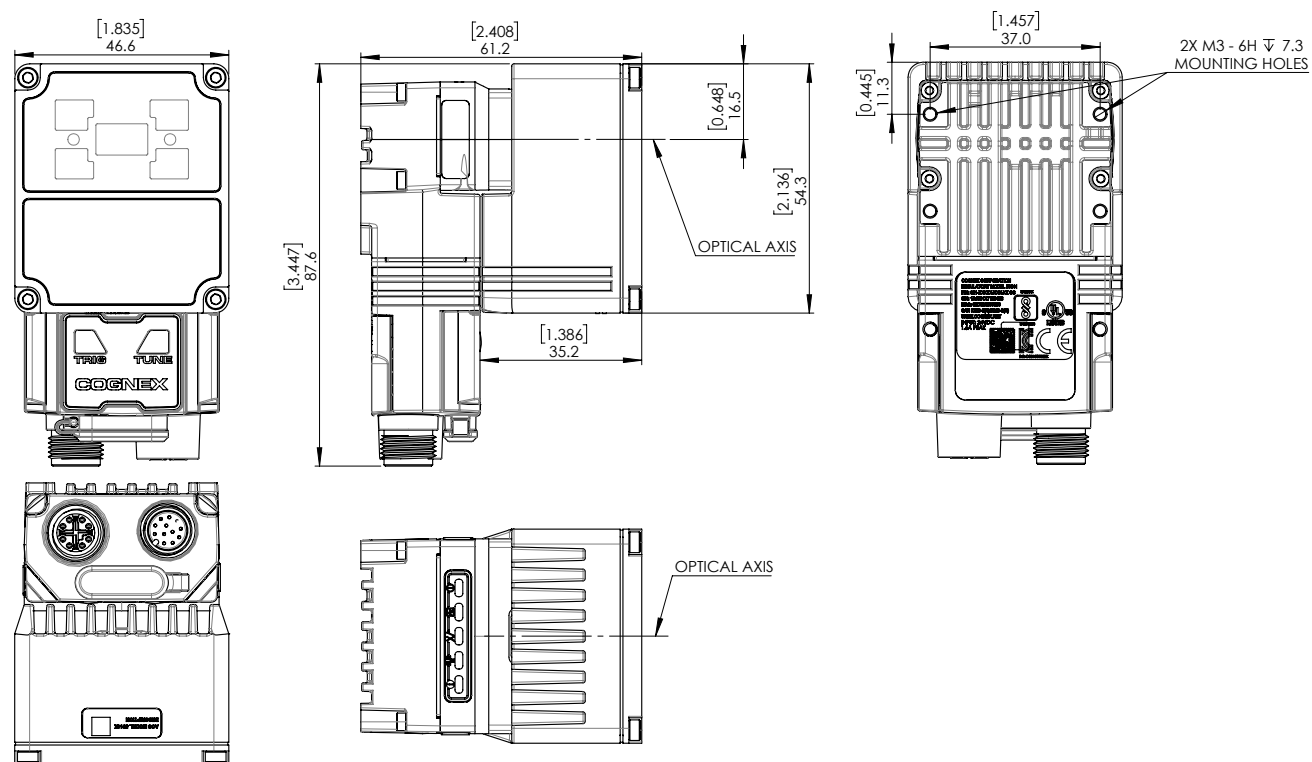

DataMan 290 with Mini Light and 6.2 mm Lens

[Download CAD files](#)

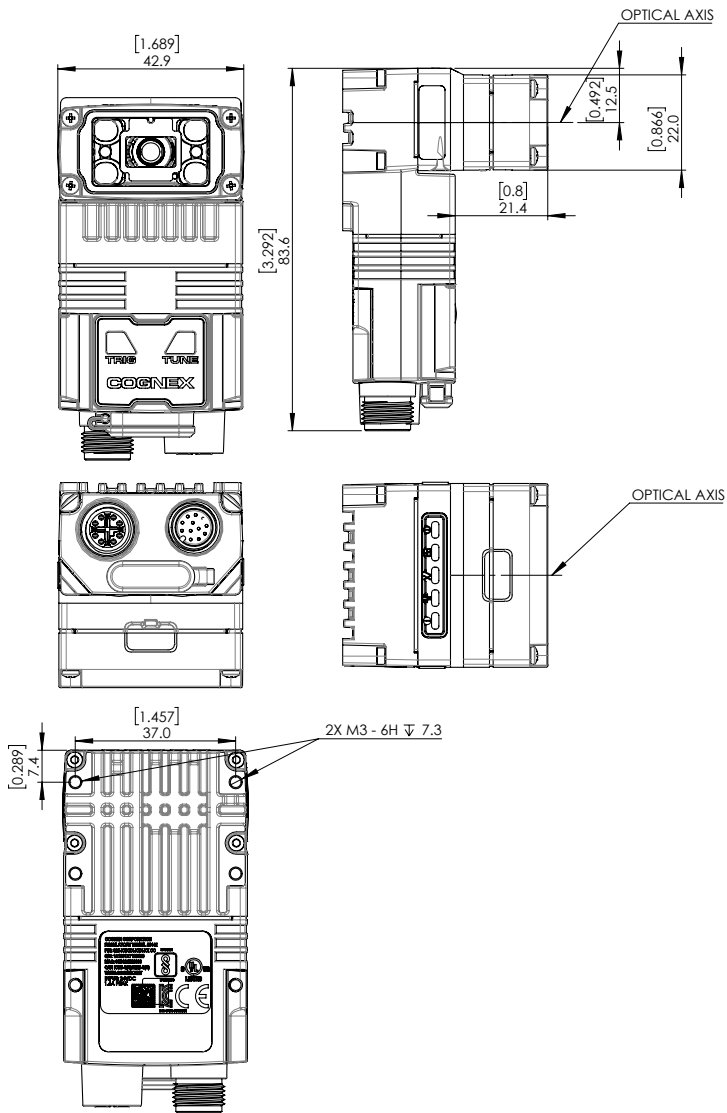

DataMan 290 with Mini Light and 16 mm Lens

[Download CAD files](#)

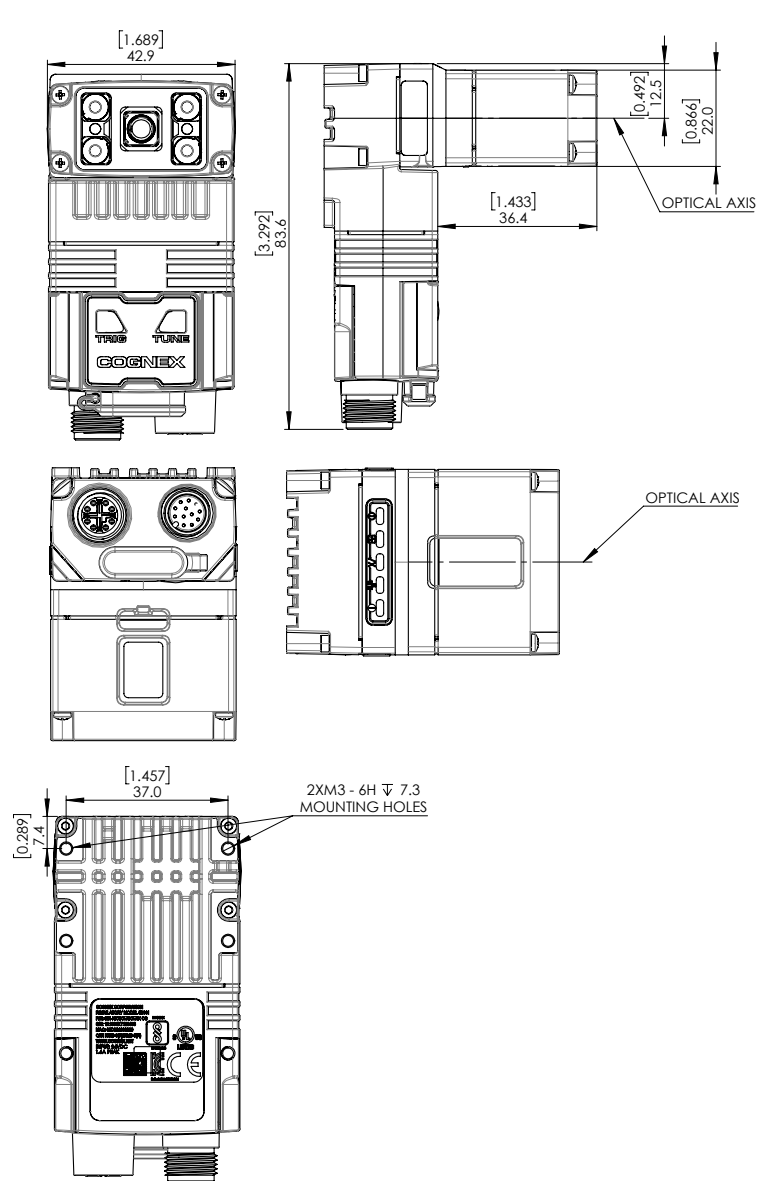

DataMan 290 Universal Mounting Bracket

[Download CAD files](#)

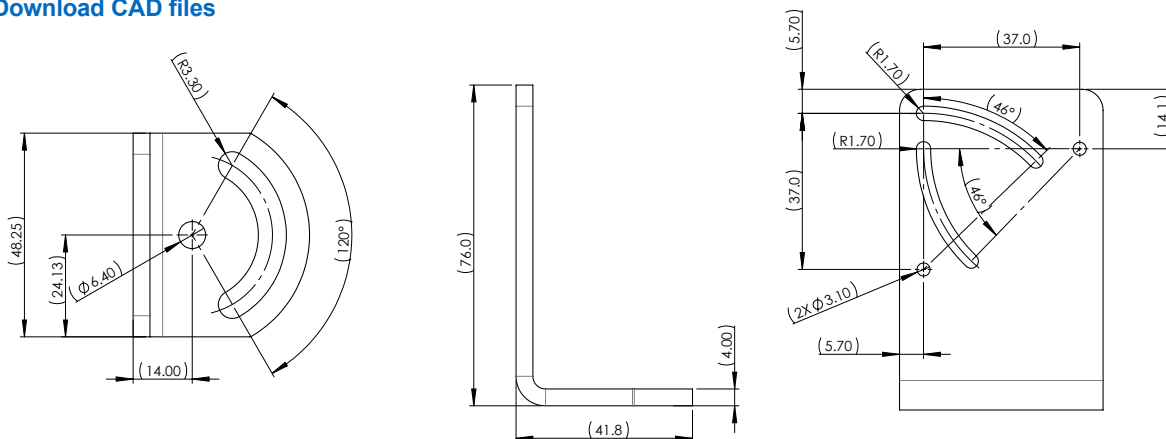

Cable bend radius

*R MIN = 10 X CABLE DIAMETER

TYPICAL:

POWER CABLE: Ø7.1 (.28)

ETHERNET CABLE: Ø7.1 (.28)

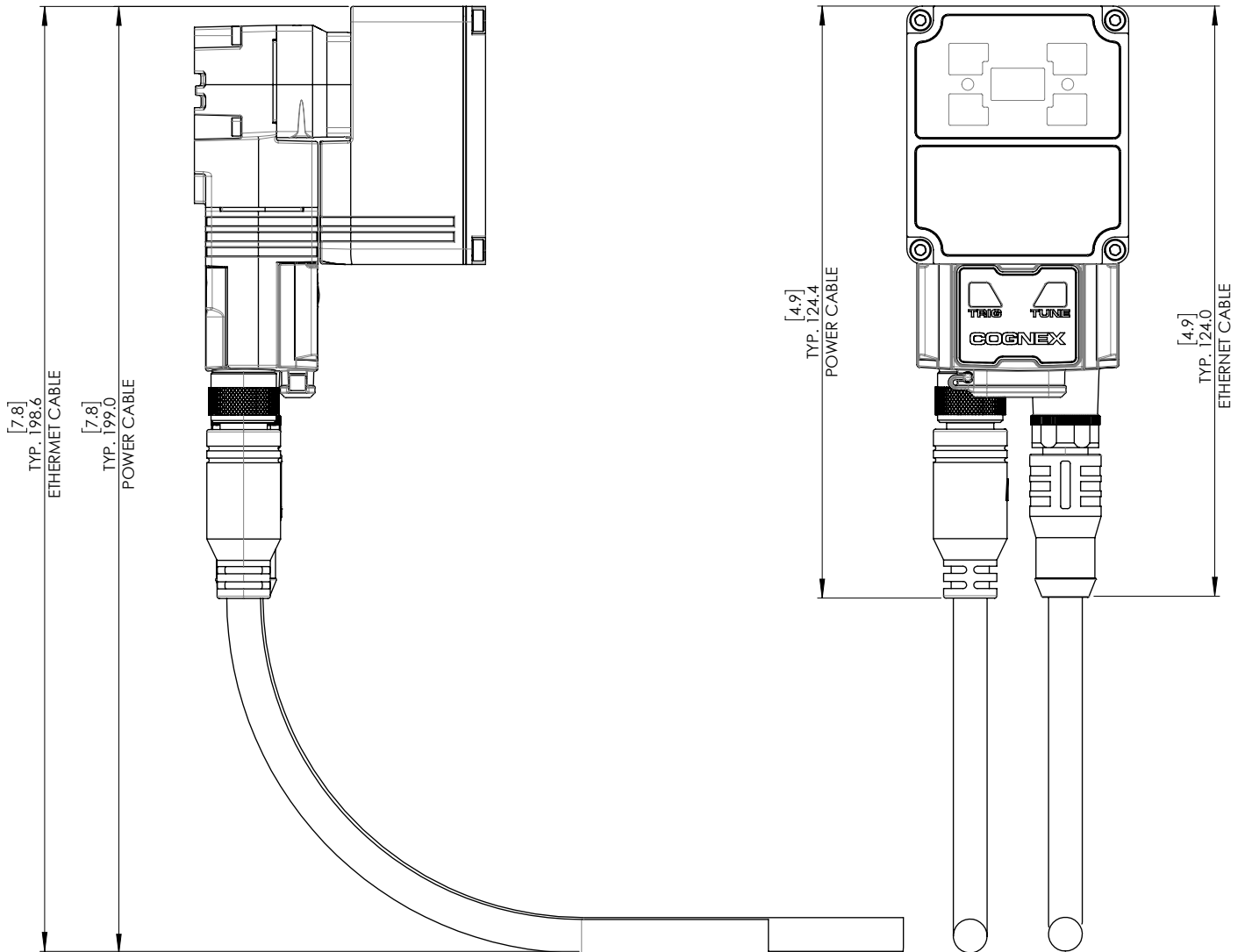

Build Your Vision

Vision Systems

Advanced AI makes it easy to deploy vision systems for automating inspection tasks, from defect detection to assembly verification and text reading.

www.cognex.com/machine-vision



Barcode Readers

Track and trace from the floor to dock door, with flexible readers and verifiers designed for ease of use and reliability.

www.cognex.com/barcodereaders



Industry Solutions

Tackle complex applications across a wide range of industries with powerful machine vision solutions that simplify today's manufacturing and logistics challenges.

www.cognex.com/solutions



COGNEX

Companies around the world rely on Cognex vision and barcode reading solutions to optimize quality, drive down costs, and control traceability.

Corporate Headquarters One Vision Drive Natick, MA 01760 USA

Contact us or find your regional sales office:
www.cognex.com/sales

Americas

North America +1 855 426 4639
Brazil +1 855 426 4639
Mexico +52 552 789 5444

Europe

Austria +49 721 958 8052
Belgium (FR) +33 176 549 318
France +33 176 549 318
Germany +49 721 958 8052
Ireland +353 21 601 9005
Italy +39 02 9475 4345
Spain +34 93 220 6237
Switzerland (DE) +49 721 958 8052
Switzerland (FR) +33 176 549 318
United Kingdom +353 21 601 9005
Other Europe +353 21 601 9005

Asia-Pacific

China +86 218 036 5424
India +91 7305 040397
Japan +81 345 790 266
Korea +82 704 784 4038
Singapore +65 3158 2511
Taiwan +886 0801-863-159
Other Asia-Pacific +65 3158 2511

© Copyright 2025, Cognex Corporation.
All information in this document is subject to change without notice. All Rights Reserved. Cognex and DataMan are registered trademarks of Cognex Corporation. PowerGrid is a trademark of Cognex Corporation. All other trademarks are property of their respective owners.

Lit. No. DM290DS-EN-01-2025

www.cognex.com