

This guide provides basic installation information for specific UniStream® PLC models with built-in I/O. Technical specifications may be downloaded from the Unitronics website.

General Features

Unitronics' UniStream® PLCs are DIN-rail mounted Programmable Logic Controllers (PLCs) with a built-in I/O configuration.

The series is available in three versions: Pro, Standard, and Basic.

Note that a model number that includes:

- **B10/C10** refers to Pro version (e.g. USC-B10-T24)
- **B5/C5** refers to Standard version (e.g. USC-B5-RA28)
- **B3/C3** refers to Basic version (e.g. only for USC-B3-T20)

Page 2 contains a comparison table detailing the features offered by the different models. Exact features are detailed in the product specification sheets.

Power Features	<ul style="list-style-type: none">▪ Built-in Trends and Gauges, auto-tuned PID, data tables, data sampling, and Recipes▪ UniApps™: Access & edit data, monitor, troubleshoot & debug and more▪ Security: Multi-level password protection▪ Alarms: Built-in system, ANSI/ISA standards
COM Options	<ul style="list-style-type: none">▪ Built-in ports: 2 Ethernet, 1 USB host, 1 USB device port▪ Add-on ports (UAC-CB), available by separate order:<ul style="list-style-type: none">➢ 1 CANbus port may be added to all models➢ RS232/485 ports: according to model technical specifications
COM Protocols	<ul style="list-style-type: none">▪ Fieldbus: CANopen, CAN Layer2, MODBUS, EtherNetIP and more. Implement any serial RS232/485, TCP/IP, or CANbus third-party protocols via Message Composer▪ Advanced: SNMP Agent/Trap, e-mail, SMS, modems, GPRS/GSM, FTP Server/Client, Web Server, SQL, and MQTT.▪ Remote Access via any device that supports VNC.
Programming Software	All-in-One UniLogic software for hardware configuration, communications, PLC and HMI applications; free download.
HMI	All UniStream® PLCs can display HMI screens on the following devices: <ul style="list-style-type: none">• UniStream Display (USL)• UniStream Modular HMI panel (USP)• UniStream Built-in (on the panels integral to the device)• Any device screen that supports VNC

HMI	<p>HMI screens are designed in UniLogic. In addition to the HMI screens, UniStream® PLCs offer built-in HMI features, including:</p> <ul style="list-style-type: none"> • UniApps™: Access & edit data, monitor, troubleshoot, debug, and more • Security: Multi-level password protection • Alarms: Built-in system, ANSI/ISA standards
------------	---

USB Action files	<p>Programmers can create files in UniLogic and save them to a USB mass storage device, such as a flash drive. This enables the end user to implement certain actions such as to update firmware, update network settings, download applications, extract log files and more.</p>
-------------------------	---

Comparison table	Feature	B10/C10 Pro	B5/C5 Standard	B3/C3 Basic
	I/O Expansion via Uni-I/O	Yes		No
	Remote I/O Expansion via Ethernet I/O Adapter (URB)	Up to 8		1
	VFD	32		2
	MicroSD	Yes		No*
	Add-on COM modules	3		2
	System Memory	6GB	3GB	3GB
	MODBUS Slaves	Unlimited		Up to 8
	Ethernet/IP Scanners	16		1
	Ethernet/IP Adapters	32		8
	Web Server	Yes	No	No
	SQL Client	Yes	No	No
	MQTT	Yes		
	PID Loops	64		2
	Data Sampler/Trends	Yes		No
	CSV files: creating/ reading	Yes		No
	FTP, server/client	Yes		No
	Saving Data Tables to SD	Yes		No*
	Screenshots	Yes		No
	Sending email attachments	Yes		No
	USB device (programming port)	Yes		No**

* Note that B3/C3 models do not support features requiring SD cards. In addition, Alarm History is not retained after PLC reset.

** Note that B3/C3 models may be programmed only via Ethernet cable.



Before You Begin

Before installing the device, the user must:

- Read and understand this document.
- Verify the Kit Contents.

Alert Symbols and General Restrictions

When any of the following symbols appear, read the associated information carefully.

Symbol	Meaning	Description
	Danger	The identified danger causes physical and property damage.
	Warning	The identified danger could cause physical and property damage.
Caution	Caution	Use caution.

- All examples and diagrams are intended to aid understanding, and do not guarantee operation. Unitronics accepts no responsibility for actual use of this product based on these examples.
- Please dispose of this product according to local and national standards and regulations.
- This product should be installed only by qualified personnel.

-  Failure to comply with appropriate safety guidelines can cause severe injury or property damage.
 - Do not attempt to use this device with parameters that exceed permissible levels.
 - Do not connect/disconnect the device when power is on.

Environmental Considerations

-  Ventilation: 10mm space is required between the device top/bottom edges and the enclosure's walls
 - Do not install in areas with: excessive or conductive dust, corrosive or flammable gas, moisture or rain, excessive heat, regular impact shocks or excessive vibration, in accordance with the standards and limitations given in the product's technical specification sheet.
 - Do not place in water or let water leak onto the unit.
 - Do not allow debris to fall inside the unit during installation.
 - Install at maximum distance from high-voltage cables and power equipment.

Kit Contents

- 1 UniStream PLC
- 1 power terminal block
- 3 I/O terminal blocks (provided only with models comprising built-in I/Os)
- 1 Battery

Product Diagram

1	Output LEDs	Green / Red LEDs
2	Status LEDs	Tricolor LEDs, Green/Red/Orange From top to bottom: RUN, ERROR, USB, BATT. LOW, and FORCE. Note that LED indications are listed in the product's technical specifications.
3	DIN-rail clips	Clips at top and bottom physically support the device
4	Input LEDs	Green / Red LEDs
5	Top Door, Closed	Covers the Confirm button and the USB Host port
6	Bottom Door, Closed	Covers the internal door protecting the battery and microSD slot.

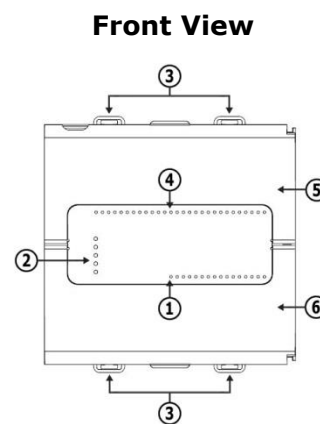

7	Uni-COM™ Jack	Connection port for Uni-COM CB modules*. Shipped covered; leave cover in place when not in use.
8	Ethernet ports	Two ports for Ethernet communications.
9	Input/Output connection points	Model-dependent. Present in models with built-in I/O configurations.
10	I/O Bus connector	(Not shown) Connection point for Uni-I/O™ modules and I/O expansion adapters, shipped covered. Leave covered when not in use.
11	CONFIRM Button	Used to implement and confirm USB Actions.
12	USB Host port	Provides the interface for external USB devices.

Top View

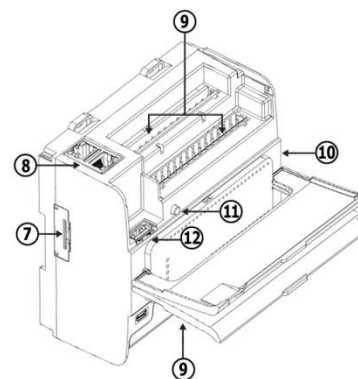

13	Internal Door, open	Open this to access the battery + microSD slot.
14	Power Supply Input	Connection point for the controller power source. Connect the Terminal Block supplied with the kit to the power cable.
15	USB Device port	Use for application download and direct PC-UniStream communication.
16	microSD Slot	Supports standard microSD cards.
17	Battery Holder	The battery is supplied installed; the user must remove the pull tab during installation.

Bottom View

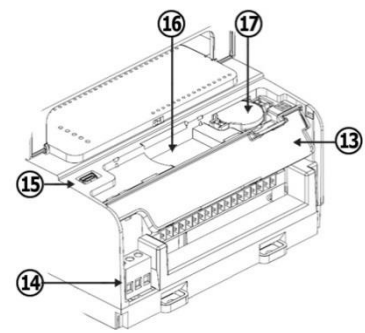

* These are available by separate order.

Installation Space Considerations

Allocate space for:

- The controller
 - I/O wiring
 - Access to ports, jacks, and the microSD card slot
 - Any modules that will be installed; ensure you allow space to install/uninstall modules
Module dimensions and installation instructions are in the modules' specifications.
- For exact dimensions, please refer to the Mechanical Dimensions shown below.

Mechanical Dimensions

Front View

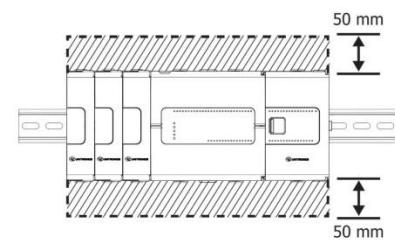
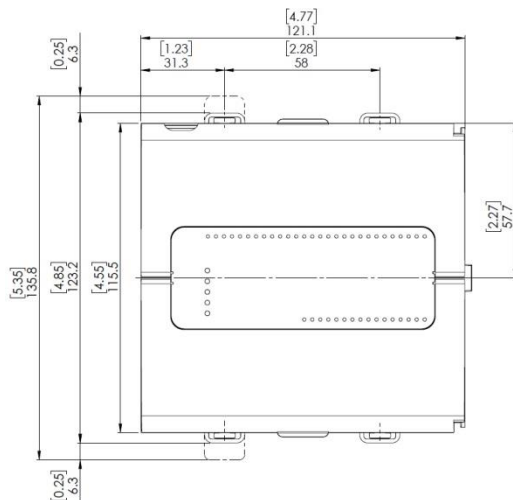

Bottom View

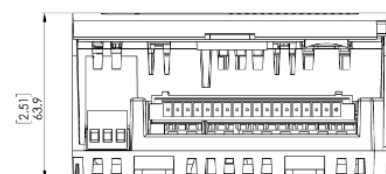

Mounting

- Note
- Mount on a standard DIN-rail.
 - Ensure that there is sufficient room on the sides of the device to allow for any I/O or COM modules.

1. Push the device onto the DIN-rail until the clips located at the top and bottom of the unit have snapped onto the DIN-rail.
2. When properly mounted, the device is squarely situated on the DIN-rail as shown below.

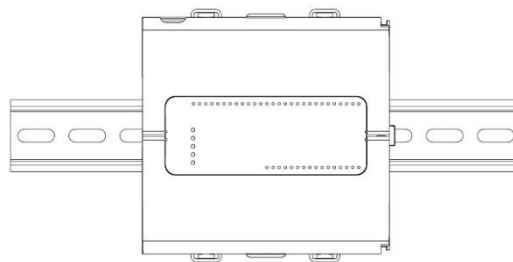

Battery: Back-up, First Use, Installation, and Replacement

Back-up

In order to preserve back-up values for RTC and system data in the event of power off, the battery must be connected.

First Use

The battery is protected by the PLC's bottom and inner door.

The battery is supplied installed inside the unit, with a plastic tab preventing contact.

Pull out this tab before using the device.

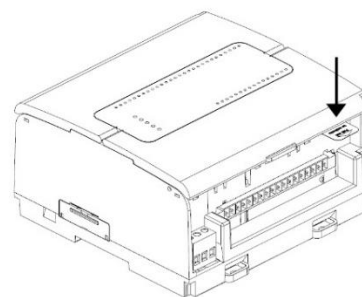

Battery Installation and Replacement

- ⚠ ▪ Use proper precautions to prevent Electro-Static Discharge (ESD) while servicing the battery.

- Caution
- To preserve back-up values for RTC and system data during battery replacement, the controller must be powered.
 - Note that disconnecting the battery halts the preservation of back-up values and causes them to be deleted.

1. Open the bottom and inner doors.
2. If there is a battery present, remove it.
3. Slide the battery into place.

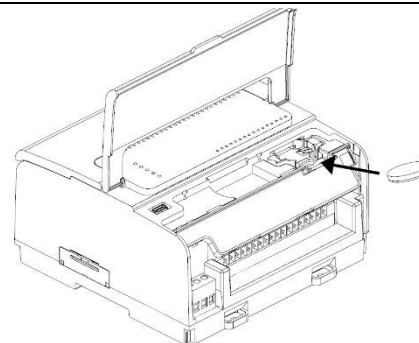

microSD Card Installation and Removal

- ⚠ Use proper precautions to prevent Electro-Static Discharge (ESD) while servicing the microSD card.

1. To install the microSD card slide it into the slot as shown in the accompanying figure, until the card clicks into place.
2. To remove the card, press it into its slot lightly, the spring ejects it.

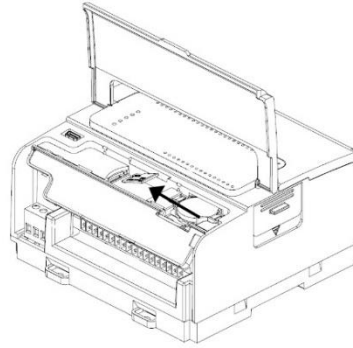

Wiring

- ⚠ This equipment is designed to operate only at SELV/PELV/Class 2/Limited Power environments.
 - All power supplies in the system must include double insulation. Power supply outputs must be rated as SELV/PELV/Class 2/Limited Power.
 - Do not connect either the 'Neutral' or 'Line' signal of the 110/220VAC to device's 0V point.
 - Do not touch live wires.
 - All wiring activities should be performed while power is OFF.
 - Use over-current protection, such as a fuse or circuit breaker, to avoid excessive currents into the power supply connection point.
 - Unused points should not be connected (unless otherwise specified). Ignoring this directive may damage the device.
 - Double-check all wiring before turning on the power supply.

- Caution
- To avoid damaging the wire, use a maximum torque of 0.5 N·m (4.4 in-lb).
 - Do not use tin, solder, or any substance on stripped wire that might cause the wire strand to break.
 - Install at maximum distance from high-voltage cables and power equipment.

Wiring Procedure

Use crimp terminals for wiring; use 26-12 AWG wire (0.13 mm² –3.31 mm²)

1. Strip the wire to a length of 7±0.5mm (0.250–0.300 inches).
2. Unscrew the terminal to its widest position before inserting a wire.
3. Insert the wire completely into the terminal to ensure a proper connection.
4. Tighten enough to keep the wire from pulling free.

Wiring Guidelines

In order to ensure that the device will operate properly and to avoid electromagnetic interference:

- Use a metal cabinet. Make sure the cabinet and its doors are properly earthed.
- Use wires that are properly sized for the load.
- Use shielded twisted pair cables for wiring High Speed and Analog I/O signals.
Use shielded cables for wiring thermocouple and RTD signals.
In either case, do not use the cable shield as a signal common / return path.
- Route each I/O signal with its own dedicated common wire. Connect common wires at their respective common (CM) points at the controller.

- Individually connect each 0V point and each common (CM) point in the system to the power supply 0V terminal, unless otherwise specified.
- Individually connect each functional ground point (⏏) to the earth of the system (preferably to the metal cabinet chassis).
Use the shortest and thickest wires possible: less than 1m (3.3') in length, minimum thickness 14 AWG (2 mm²).
- Connect the power supply 0V to the earth of the system.
- Earthing the cables' shield:
 - Connect the cable shield to the earth of the system (preferably to the metal cabinet chassis). Note that the shield must be connected only at one end of the cable; it is recommended to earth the shield at the PLC-side.
 - Keep shield connections as short as possible.
 - Ensure shield continuity when extending shielded cables.

NOTE For detailed information, refer to the document System Wiring Guidelines, located in the Technical Library in the Unitronics' website.

Wiring the Power Supply

The controller requires an external power supply.

- ⚠ ▪ In the event of voltage fluctuations or non-conformity to voltage power supply specifications, connect the device to a regulated power supply.

Connect the +V and 0V terminals as shown in the accompanying figure.

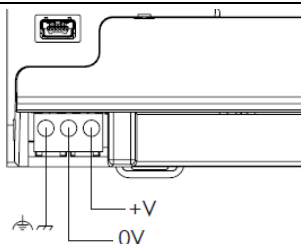

Connecting Ports

- Ethernet **CAT-5e shielded cable with RJ45 connector**
- USB Device **Use a standard USB cable, Type mini-B**
- USB Host **Standard USB Type-A plug**

Note that below, the letters “xx” that is used in the model numbers means that the section refers both to B5/C5 and B10/C10 models.

I/O Connection Points

The IOs for these models are arranged in three groups of fifteen points each, as shown in the figure to the right.

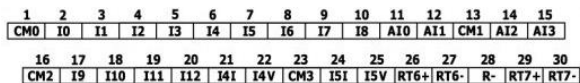

Top groups

Input connection points

Bottom group

Output connection points

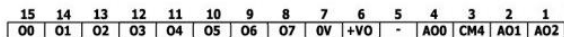

The function of certain I/Os may be adapted via wiring and software settings.

Wiring the Digital Inputs

The digital inputs are arranged in two isolated groups:

- I0-I8 share common CM0
- I9-I12 share common CM2

Each group may be wired together as sink or source.

Inputs I9, I10, I11 and I12 can be configured as either normal digital inputs or as high speed inputs that can receive high speed pulse signals from sensors or shaft encoders.

High Speed Input Modes

Following are the different pin assignments for the high speed channels:

	Channel 1		Channel 2	
	I9	I10	I11	I12
Quadrature	Phase A	Phase B	Phase A	Phase B
Pulse+Direction	Pulse	Direction	Pulse	Direction
Pulse	Pulse	Normal digital	Pulse	Normal digital

NOTE ▪ Input modes are set both by wiring and software.

Input wiring, sink

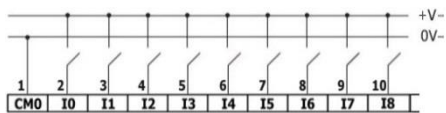

Input wiring, source

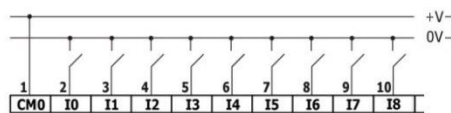

High Speed Input wiring, sink

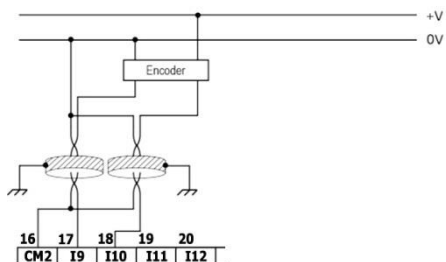

High Speed Input wiring, source

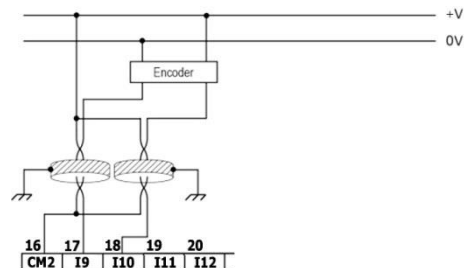

NOTE Use sink input wiring to connect a sourcing (pnp) device.
Use source input wiring to connect a sinking (npn) device.

Wiring Analog Inputs 0 to 3

All four inputs share the common point CM1.

- NOTE**
- The inputs are not isolated.
 - Each input offers two modes: voltage or current. You can set each input independently.
 - The mode is determined by the hardware configuration within the software application.
 - Note that if, for example, you wire the input to current, you must also set it to current in the software application.

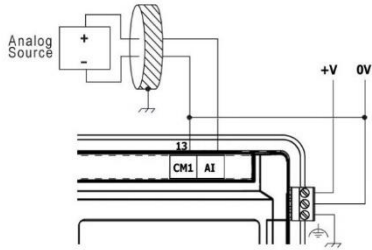
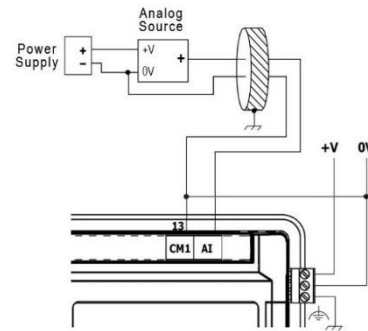
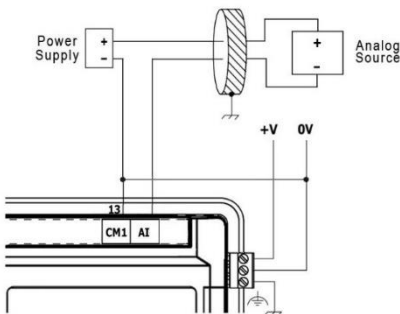
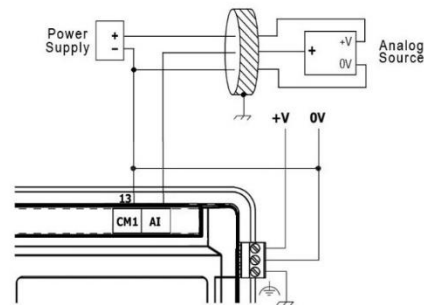
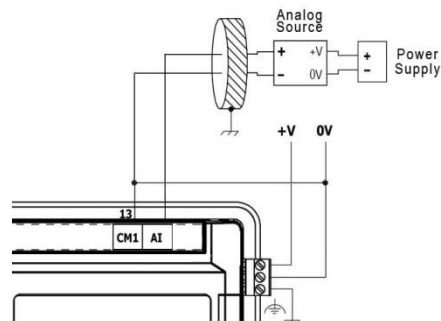
Voltage**Differential****Single-ended****Current****2-wire****3-wire****4-wire**

Wiring Analog Inputs 4 to 5

Both inputs share the common point CM3.

- NOTE**
- Each input offers two modes: voltage or current. You can set each input independently. The mode is determined both by wiring and by the hardware configuration within the software application.
 - Voltage and current modes use distinct points. Connect only the point associated with the selected mode; leave the other point unconnected.

Voltage

Differential

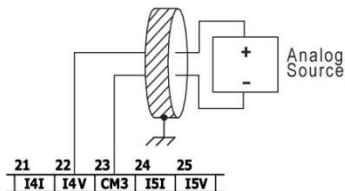

Single-ended

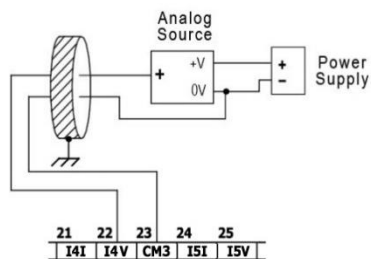

Current

2-wire

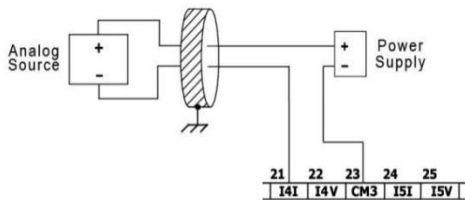

3-wire

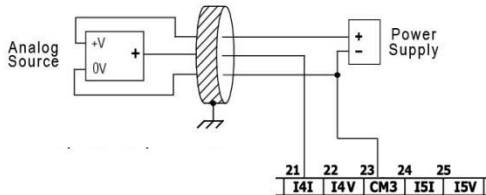

4-wire

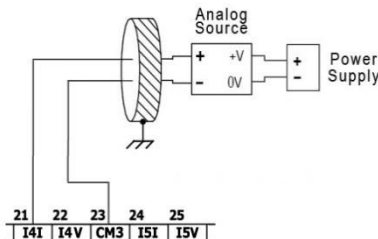

Wiring the Temperature Inputs

NOTE Each input offers three modes: thermocouple, mV or RTD. You can set each input independently. The mode is determined both by wiring and by the hardware configuration within the software application.

In order to ensure that the temperature inputs operate correctly, connect the points RTn+ and RTn- of unused temperature inputs together. Note that 'n' designates input number).

Thermocouple and mV

Thermocouple

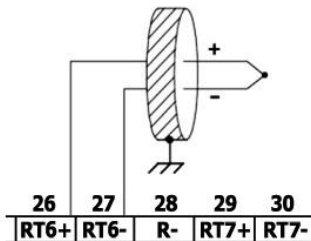

mV

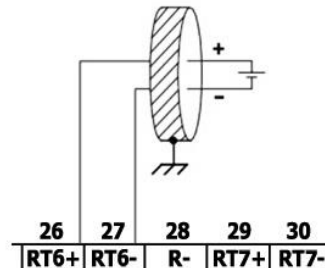

About Thermocouple Isolation

Although the temperature inputs are isolated from the bus and the controller's power-supply port, they are neither isolated from each other nor from the analog inputs. Therefore, temperature inputs isolation may be bypassed when using an exposed-junction (non-isolated) thermocouple in conjunction with analog inputs or another exposed-junction thermocouple, which can lead to flow of unwanted currents through the thermocouple wires that might interfere with thermocouple voltage reading.

In order to maintain temperature inputs isolation when using one or more of the analog inputs or when using more than one thermocouple, either:

- Use isolated-junction thermocouples, or, if you are not using the analog inputs, you may use up to one exposed-junction thermocouple;
- Electrically isolate exposed-junction thermocouples from other electrically-conductive parts of the system.

RTD

- NOTE**
- When connecting 3- or 4-wire RTDs, make sure to use conductors of the same type, width, and length for all RTD wires, otherwise the accuracy will degrade.
 - When connecting 4-wire RTDs, use 3-wire cable and leave the unused wire unconnected and of minimal length.

2-wire

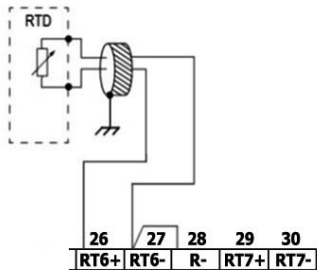

3-wire

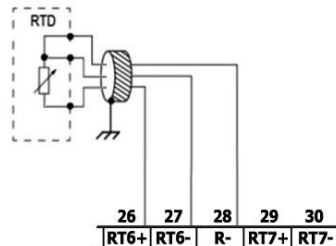

4-wire

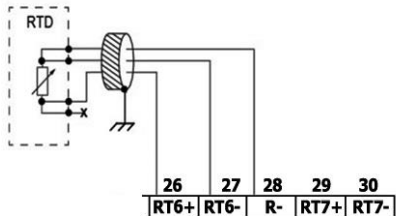

Wiring the Source Transistor Outputs

Output's power supply

The use of any of the outputs requires an external 24VDC power supply as shown in the accompanying figure.

Outputs

Connect the +VO and 0V terminals as shown in the accompanying figure.

00-07 share common return 0V.

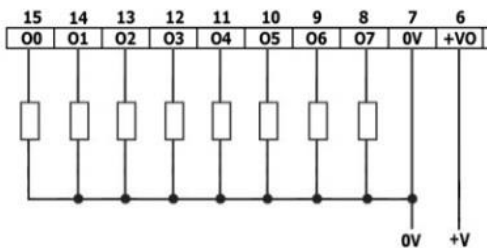

Wiring the Analog Outputs

- NOTE**
- The outputs are not isolated.
 - Each output offers two modes: voltage or current. You can set each output independently.
 - The mode is determined by the hardware configuration within the software application.
 - Note that if, for example, you wire the output to current input, you must also set it to current in the software application.

CM4 is internally connected to the 0V point. To minimize EMI pickup by analog signals' wiring, do not externally connect CM4 to the system 0V.

- ⚠
- Do not use point CM4 for any purpose other than connecting the analog output load. Using it for any other purpose may damage the controller.

Voltage / Current

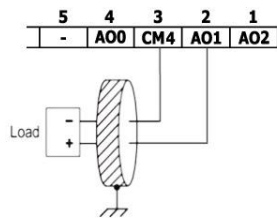

Installing Uni-I/O™ & Uni-COM™ Modules

Refer to the Installation Guides provided with these modules.

- ⚠
- Turn off system power before connecting or disconnecting any modules or devices.
 - Use proper precautions to prevent Electro-Static Discharge (ESD).

Uninstalling the Controller

1. Disconnect the power supply.
2. Remove all wiring and disconnect any installed devices according to the device's installation guide.
3. Unscrew and remove the mounting brackets, taking care to support the device to prevent it from falling during this procedure.

UniStream[®] PLC

Technical Specifications

**USC-B5-TA32, USC-B10-TA32,
USC-C5-TA32, USC-C10-TA32**

Unitronics' UniStream[®] PLCs are DIN-rail mounted Programmable Logic Controllers (PLCs) with a built-in I/O configuration.

UniStream connects directly to UniCloud, Unitronics' IIoT cloud platform using built-in UniCloud connectivity. More information about UniCloud is available at www.unitronics.cloud.

Model numbers in this document

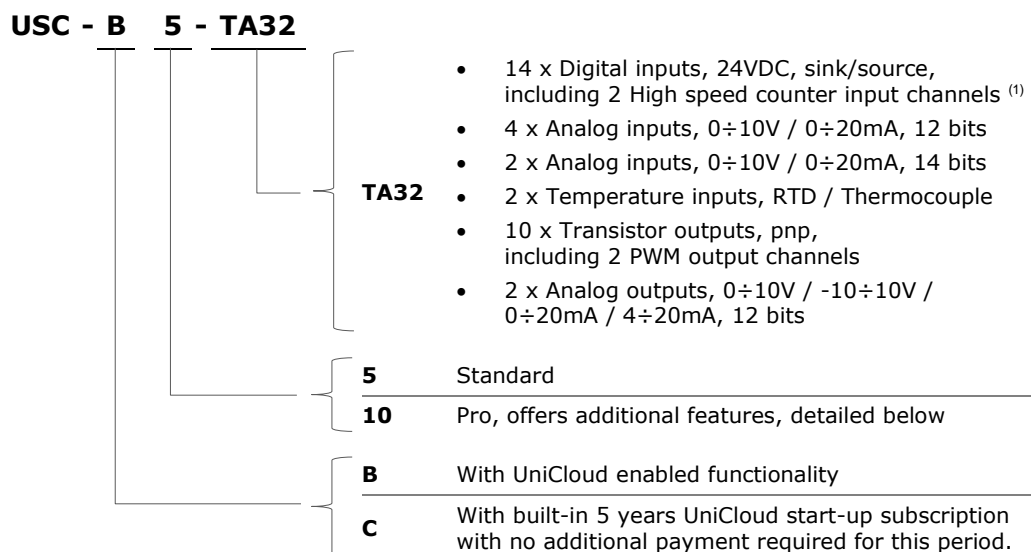

Installation Guides are available in the Unitronics Technical Library at www.unitronicsplc.com.

Power Supply	
Input voltage	24VDC
Permissible range	20.4VDC to 28.8VDC
Max. current consumption	0.42A@24VDC
Isolation	None

General		
I/O support	Up to 2,048 I/O points	
Built-in I/O	According to model	
Local Uni-I/O™ support	Up to 8 I/O modules can be connected directly to the controller. You can connect up to 88 I/O modules to a single controller using Local I/O Expansion adapters ⁽²⁾ . For complete details refer to Local I/O Expansion adapters technical specification.	
Remote I/O	Up to 8 UniStream Remote I/O Adapters (URB)	
Communication ports		
Built-in COM ports	Specifications are provided below in the section Communications	
Add-on Ports	Add up to 3 ports to a single controller using Uni-COM™ UAC-CB Modules ⁽³⁾ .	
Internal memory	Standard (B5/C5)	Pro (B10/C10)
	RAM: 512MB ROM: 3GB system memory 1GB user memory	RAM: 1GB ROM: 6GB system memory 2GB user memory
Ladder memory	1 MB	
External memory	microSD or microSDHC card Size: up to 32GB, Data Speed: up to 200Mbps	
Bit operation	0.13 μs	
Battery	Model: 3V CR2032 Lithium battery ⁽⁴⁾ Battery lifetime: 4 years typical, at 25°C Battery Low detection and indication (via BATT. LOW indicator and via System Tag).	

Communication (Built-in Ports)	
Ethernet port	
Number of ports	2
Port type	10/100 Base-T (RJ45)
Auto crossover	Yes
Auto negotiation	Yes
Isolation voltage	500VAC for 1 minute
Cable	Shielded CAT5e cable, up to 100 m (328 ft)
USB device ⁽⁵⁾	
Number of ports	1
Port type	Mini-B
Data rate	USB 2.0 (480Mbps)
Isolation	None
Cable	USB 2.0 compliant; < 3 m (9.84 ft)
USB host	
Number of ports	1
Port type	Type A
Data rate	USB 2.0 (480Mbps)
Isolation	None
Cable	USB 2.0 compliant; < 3 m (9.84 ft)
Over current protection	Yes

Digital Inputs	
Number of inputs	13
Type	Sink or Source
Isolation voltage	
Input to bus	500VAC for 1 minute
Input to input	None
Nominal voltage	I0-I8: 24VDC @ 6mA I9-I12: 24VDC @ 8mA
Input voltage	
Sink/Source	On state: 15-30VDC, 4mA min. Off state: 0-5VDC, 1mA max.
Nominal impedance	I0-I8: 4k Ω I9-I12: 3k Ω
Filter	I0-I8: 6ms typical I9-I12: 5.5 μ s, 50 μ s, 0.5ms, 6ms, 12ms
High speed inputs ⁽¹⁾	
Frequency / Period	Pulse/Direction mode: 90kHz max. / 11.1 μ s min (t_p in the Pulse/Dir Mode figure below). Quadrature mode: 80kHz max. / 12.5 μ s min (t_p in the Quadrature Mode figure below).
Pulse width	Pulse/Direction mode: 5.1 μ s min. for each state (t_w in Pulse/Dir Mode figure below). Quadrature mode: 2.5 μ s min. for each state (t_w in Quadrature Mode figure below).
Cable	Shielded twisted pair

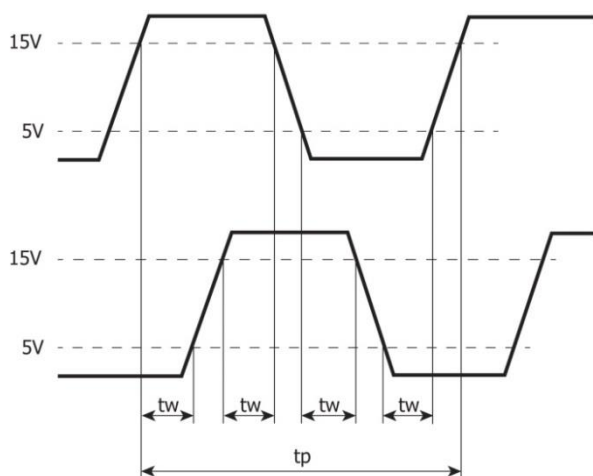

Quadrature Mode

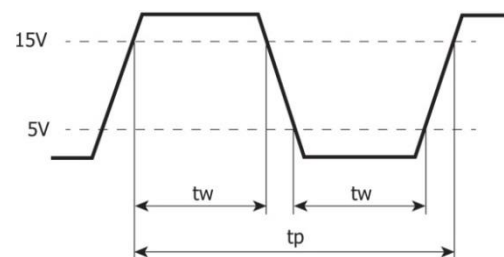

Pulse/Direction mode

Analog Inputs 0 to 3					
Number of inputs	4				
Input range ^{(6) (7)}	Input Type	Nominal Values		Over-range Values *	
	0 ÷ 10VDC	0 ≤ Vin ≤ 10VDC		10 < Vin ≤ 10.15VDC	
	0 ÷ 20mA	0 ≤ Iin ≤ 20mA		20 < Iin ≤ 20.3mA	
	* Overflow ⁽⁸⁾ is declared when an input value exceeds the Over-range boundary.				
Absolute maximum rating	±30V (Voltage), ±30mA (Current)				
Isolation	None				
Conversion method	Successive approximation				
Resolution	12 bits				
Accuracy (25°C / -20°C to 55°C)	±0.3% / ±0.9% of full scale				
Input impedance	541kΩ (Voltage), 248Ω (Current)				
Noise rejection	10Hz, 50Hz, 60Hz, 400Hz				
Step response ⁽⁹⁾ (0 to 100% of final value)	Smoothing	Noise Rejection Frequency			
		400Hz	60Hz	50Hz	10Hz
	None	2.7ms	16.86ms	20.2ms	100.2ms
	Weak	10.2ms	66.86ms	80.2ms	400.2ms
	Medium	20.2ms	133.53ms	160.2ms	800.2ms
	Strong	40.2ms	266.86ms	320.2ms	1600.2ms
Update time ⁽⁹⁾	Noise Rejection Frequency		Update Time		
	400Hz		5ms		
	60Hz		4.17ms		
	50Hz		5ms		
	10Hz		10ms		
Operational signal range (signal + common mode)	Voltage mode – AIX: -1V ÷ 10.5V ; CM1: -1V ÷ 0.5V Current mode – AIX: -1V ÷ 5.5V ; CM1: -1V ÷ 0.5V (x=0 to 3)				
Cable	Shielded twisted pair				
Diagnostics ⁽⁸⁾	Analog input overflow				

Analog Inputs 4 to 5					
Number of inputs	2				
Input range ^{(6) (7)}	Input Type	Nominal Values		Over-range Values *	
	0 ÷ 10VDC	0 ≤ Vin ≤ 10VDC		10 < Vin ≤ 10.15VDC	
	0 ÷ 20mA	0 ≤ Iin ≤ 20mA		20 < Iin ≤ 20.3mA	
	* Overflow ⁽⁸⁾ is declared when an input value exceeds the Over-range boundary.				
Absolute maximum rating	±30V (Voltage), ±30V (Current)				
RTD Maximum excitation current	0.26mA				
Isolation voltage					
Input to bus	500VAC for 1 minute				
Input to input	None				
Input to temperature inputs	None				
Conversion method	Delta-sigma				
Resolution	14 bits				
Accuracy (25°C / -20°C to 55°C)	±0.2% / ±0.5% of full scale (Voltage) ±0.2% / ±0.3% of full scale (Current)				
Input impedance	527kΩ (Voltage), 60.4Ω (Current)				
Noise rejection	10Hz, 50Hz, 60Hz, 400Hz				
Step response ⁽⁹⁾ (0 to 100% of final value)	Smoothing	Noise Rejection Frequency			
		400Hz	60Hz	50Hz	10Hz
	None	162.4ms	249.5ms	249.5ms	1242.4ms
	Weak	317.3ms	491.5ms	491.5ms	2477.3ms
	Medium	627.2ms	975.4ms	975.4ms	4947ms
	Strong	1246.9ms	1943.3ms	1943.3ms	9886.5ms
Update time ⁽⁹⁾	Noise Rejection Frequency		Update Time		
	400Hz		154.9ms		
	60Hz		242ms		
	50Hz		242ms		
	10Hz		1234.9ms		
Cable	Shielded twisted pair				
Diagnostics ⁽⁸⁾	Analog input overflow				

Temperature Inputs			
Number of inputs	2		
Sensor Type	RTD (4, 3 and 2 wire ⁽¹⁰⁾), Thermocouple		
Input range ⁽¹¹⁾	Input type	Nominal values	Over/Under-range Values *
	RTD PT100 0.00385 0.00392 0.00391	-200°C ≤ T ≤ 850°C (-328°F ≤ T ≤ 1,562°F)	Under-range: -220°C ≤ T < -200°C (-364°F ≤ T < -328°F) Over-range: 850°C < T ≤ 860°C (1,562°F < T ≤ 1,580°F)
	PT1000 0.00385 0.00392		
	RTD NI100 0.00618	-100°C ≤ T ≤ 260°C (-148°F ≤ T ≤ 500°F)	Under-range: -150°C ≤ T < -100°C (-238°F ≤ T < -148°F) Over-range: 260°C < T ≤ 270°C (500°F < T ≤ 518°F)
	NI1000 0.00618		
	RTD NI120 0.00672	-80°C ≤ T ≤ 260°C (-112°F ≤ T ≤ 500°F)	Under-range: -130°C ≤ T < -80°C (-202°F ≤ T < -112°F) Over-range: 260°C < T ≤ 270°C (500°F < T ≤ 518°F)
	RTD NI100 0.00617	-60°C ≤ T ≤ 180°C (-76°F ≤ T ≤ 356°F)	Under-range: -104°C ≤ T < -60°C (-219°F ≤ T < -76°F) Over-range: 180°C < T ≤ 210°C (356°F < T ≤ 410°F)
	RTD NI1000 LG	-50°C ≤ T ≤ 190°C (-58°F ≤ T ≤ 374°F)	Under-range: -60°C ≤ T < -50°C (-76°F ≤ T < -58°F) Over-range: 190°C < T ≤ 200°C (374°F < T ≤ 392°F)
Thermocouple type J	-200°C ≤ T ≤ 1,200°C (-328°F ≤ T ≤ 2,192°F)	Under-range: -210°C ≤ T < -200°C (-346°F ≤ T < -328°F) Over-range: 1,200°C < T ≤ 1,250°C (2,192°F < T ≤ 2,282°F)	
Thermocouple type K	-200°C ≤ T ≤ 1,372°C (-328°F ≤ T ≤ 2,501.6°F)	Under-range: -270°C ≤ T < -200°C (-454°F ≤ T < -328°F) Over-range: 1,372°C < T ≤ 1,400°C (2,501.6°F < T ≤ 2,552°F)	

Thermocouple type T	$-200^{\circ}\text{C} \leq T \leq 400^{\circ}\text{C}$ ($-328^{\circ}\text{F} \leq T \leq 752^{\circ}\text{F}$)	Under-range: $-270^{\circ}\text{C} \leq T < -200^{\circ}\text{C}$ ($-454^{\circ}\text{F} \leq T < -328^{\circ}\text{F}$) Over-range: $400^{\circ}\text{C} < T \leq 430^{\circ}\text{C}$ ($752^{\circ}\text{F} < T \leq 806^{\circ}\text{F}$)
Thermocouple type E	$-200^{\circ}\text{C} \leq T \leq 1,000^{\circ}\text{C}$ ($-328^{\circ}\text{F} \leq T \leq 1,832^{\circ}\text{F}$)	Under-range: $-270^{\circ}\text{C} \leq T < -200^{\circ}\text{C}$ ($-454^{\circ}\text{F} \leq T < -328^{\circ}\text{F}$) Over-range: $1,000^{\circ}\text{C} < T \leq 1,010^{\circ}\text{C}$ ($1,832^{\circ}\text{F} < T \leq 1,850^{\circ}\text{F}$)
Thermocouple type R	$0^{\circ}\text{C} \leq T \leq 1,768^{\circ}\text{C}$ ($32^{\circ}\text{F} \leq T \leq 3,214.4^{\circ}\text{F}$)	Under-range: $-50^{\circ}\text{C} \leq T < 0^{\circ}\text{C}$ ($-58^{\circ}\text{F} \leq T < 32^{\circ}\text{F}$) Over-range: $1,768^{\circ}\text{C} < T \leq 1,800^{\circ}\text{C}$ ($3,214.4^{\circ}\text{F} < T \leq 3,272^{\circ}\text{F}$)
Thermocouple type S	$0^{\circ}\text{C} \leq T \leq 1,768^{\circ}\text{C}$ ($32^{\circ}\text{F} \leq T \leq 3,214.4^{\circ}\text{F}$)	Under-range: $-50^{\circ}\text{C} \leq T < 0^{\circ}\text{C}$ ($-58^{\circ}\text{F} \leq T < 32^{\circ}\text{F}$) Over-range: $1,768^{\circ}\text{C} < T \leq 1,800^{\circ}\text{C}$ ($3,214.4^{\circ}\text{F} < T \leq 3,272^{\circ}\text{F}$)
Thermocouple type B	$200^{\circ}\text{C} \leq T \leq 1,820^{\circ}\text{C}$ ($392^{\circ}\text{F} \leq T \leq 3,308^{\circ}\text{F}$)	Under-range: $100^{\circ}\text{C} \leq T < 200^{\circ}\text{C}$ ($212^{\circ}\text{F} \leq T < 392^{\circ}\text{F}$) Over-range: $1,820^{\circ}\text{C} < T \leq 1,870^{\circ}\text{C}$ ($3,308^{\circ}\text{F} < T \leq 3,398^{\circ}\text{F}$)
Thermocouple type N	$-210^{\circ}\text{C} \leq T \leq 1,300^{\circ}\text{C}$ ($-346^{\circ}\text{F} \leq T \leq 2,372^{\circ}\text{F}$)	Under range: $-270^{\circ}\text{C} \leq T < -210^{\circ}\text{C}$ ($-454^{\circ}\text{F} \leq T < -346^{\circ}\text{F}$) Over-range: $1,300^{\circ}\text{C} < T \leq 1,350^{\circ}\text{C}$ ($2,372^{\circ}\text{F} < T \leq 2,462^{\circ}\text{F}$)
Thermocouple type C	$10^{\circ}\text{C} \leq T \leq 2,315^{\circ}\text{C}$ ($50^{\circ}\text{F} \leq T \leq 4,199^{\circ}\text{F}$)	Under-range: $0^{\circ}\text{C} \leq T < 10^{\circ}\text{C}$ ($32^{\circ}\text{F} \leq T < 50^{\circ}\text{F}$) Over-range: $2,315^{\circ}\text{C} < T \leq 2,370^{\circ}\text{C}$ ($4,199^{\circ}\text{F} < T \leq 4,298^{\circ}\text{F}$)
Resistance	$0\Omega \leq R \leq 390\Omega$	$390\Omega < R \leq 395.85\Omega$
mV	$-70\text{mV} \leq V \leq 70\text{mV}$	Under-range: $-71.05\text{mV} \leq V < -70\text{mV}$ Over-range: $70\text{mV} \leq V < 71.05\text{mV}$
* Overflow or Underflow ⁽⁸⁾ is declared when an input value exceeds the Over-range or Under-range boundaries respectively.		

Absolute maximum rating	±9 V				
Isolation voltage					
Input to bus	500 VAC for 1 minute				
Input to input	None				
Input to analog inputs	None				
Conversion method	Delta-sigma				
Resolution	Temperature – 0.1°C (0.1°F) ⁽¹²⁾ Resistance – 14 bits mV – 13 bits plus sign				
Accuracy (25°C / -20°C to 55°C)	Input type	Accuracy			
	RTD, all types	± 0.5°C / ± 1.0°C (± 0.9°F / ± 1.8°F)			
	Thermocouple type J ⁽¹³⁾	± 0.4°C / ± 0.7°C (± 0.72°F / ± 1.26°F)			
	Thermocouple type K ⁽¹³⁾	± 0.5°C / ± 1.0°C (± 0.9°F / ± 1.8°F)			
	Thermocouple type T ⁽¹³⁾	± 0.6°C / ± 1.2°C (± 1.08°F / ± 2.16°F)			
	Thermocouple type E ⁽¹³⁾	± 0.4°C / ± 0.8°C (± 0.72°F / ± 1.44°F)			
	Thermocouple type R ⁽¹³⁾	± 1.2°C / ± 2.4°C (± 2.16°F / ± 4.32°F)			
	Thermocouple type S ⁽¹³⁾	± 1.2°C / ± 2.4°C (± 2.16°F / ± 4.32°F)			
	Thermocouple type B ⁽¹³⁾	± 2.0°C / ± 3.8°C (± 3.46°F / ± 6.84°F)			
	Thermocouple type N ⁽¹³⁾	± 1.0°C / ± 1.5°C (± 1.8°F / ± 2.7°F)			
	Thermocouple type C ⁽¹³⁾	± 0.8°C / ± 2.0°C (± 1.44°F / ± 3.46°F)			
	Resistance	± 0.05% / ± 0.1% of full scale			
mV	± 0.05% / ± 0.1% of full scale				
Noise rejection	10Hz, 50Hz, 60Hz, 400Hz				
Step response ⁽⁹⁾ (0 to 100% of final value)	Smoothing	Noise Rejection Frequency			
		400Hz	60Hz	50Hz	10Hz
	None	162.4ms	249.5ms	249.5ms	1242.4ms
	Weak	317.3ms	491.5ms	491.5ms	2477.3ms
	Medium	627.2ms	975.4ms	975.4ms	4947ms
Strong	1246.9ms	1943.3ms	1943.3ms	9886.5ms	
Update time ⁽⁹⁾	Noise Rejection Frequency			Update Time	
	400Hz			154.9ms	
	60Hz			242ms	
	50Hz			242ms	
10Hz			1234.9ms		
Thermocouple Cold junction error ⁽¹³⁾	±1.5°C (±2.7°F)				
Cable	Shielded, see installation guide for details				
Diagnostics ⁽⁸⁾	Input Overflow or Underflow, sensor connection fault ⁽¹⁴⁾				

Source Transistor Outputs	
Number of outputs	8
Output type	Transistor, Source (pnp)
Isolation voltage	
Output to bus	500VAC for 1 minute
Output to output	None
Outputs power supply to bus	500VAC for 1 minute
Outputs power supply to output	None
Current	0.5A maximum per output
Voltage	See Source Transistor Outputs Power Supply specification below
ON state voltage drop	0.5V maximum
OFF state leakage current	10 μ A maximum
Switching times	Turn-on/off: 80 μ s maximum, Turn-off: 155 μ s maximum (Load resistance < 4k Ω)
PWM Frequency ⁽¹⁶⁾	O0, O1: 3kHz max. (Load resistance < 4k Ω)
Short-circuit protection	Yes

Source Transistor Outputs Power Supply	
Nominal operating voltage	24VDC
Operating voltage	20.4 – 28.8VDC
Maximum current consumption	30mA@24VDC Current consumption does not include load current

Analog Outputs			
Number of outputs	3		
Output range ⁽¹⁷⁾	Output Type	Nominal Values	Over/Under-range Values *
	0 ÷ 10VDC	$0 \leq V_{out} \leq 10VDC$	$10 < V_{out} \leq 10.15VDC$
	-10 ÷ 10VDC	$-10 \leq V_{out} \leq 10VDC$	$-10.15 \leq V_{out} < -10VDC$ $10 < V_{out} \leq 10.15VDC$
	0 ÷ 20mA	$0 \leq I_{out} \leq 20mA$	$20 \leq I_{out} \leq 20.3mA$
	4 ÷ 20mA	$4 \leq I_{out} \leq 20mA$	$20 \leq I_{out} \leq 20.3mA$
	* Overflow or Underflow is declared when an output value exceeds the Over-range or Under-range boundaries respectively.		
Isolation	None		
Resolution	0 ÷ 10VDC – 12 bit -10 ÷ 10VDC – 11 bit + sign 0 ÷ 20mA – 12 bit 4 ÷ 20mA – 12 bit		
Accuracy (25°C / -20°C to 55°C)	±0.3% / ±0.5% of full scale (Voltage) ±0.5% / ±0.7% of full scale (Current)		
Load impedance	Voltage – 1kΩ minimum Current – 600Ω maximum		
Settling time (95% of new value)	0 ÷ 10VDC – 1.8ms (2kΩ resistive load), 3.7ms (2kΩ + 1uF load) -10 ÷ 10VDC – 3ms (2kΩ resistive load), 5.5ms (2kΩ + 1uF load) 0 ÷ 20mA and 4 ÷ 20mA – 1.7ms (600Ω load), 1.7ms (600Ω + 10mH load)		
Short circuit protection (voltage mode)	Yes (no indication)		
Cable	Shielded twisted pair		
Diagnostics ⁽⁸⁾	Current – Open circuit indication Supply level – Normal / Low or missing		

LED Indications				
I/O LEDs	Color	Indication		
Digital Input	Green	Input state		
Analog Input	Red	On: Input value is in Overflow		
Temperature Input	Red	On: Input value is in Overflow, Underflow, or a connection fault occurs		
Relay and Transistor Output	Green	Output state		
Analog Output	Red	On: Open Circuit (when set to Current mode)		
Status LEDs	Color & State		Indication	
RUN	Green	On	Run mode	
		Blink	This indication is in conjunction with the USB LED. See table below, USB Actions Indications, for details	
	Orange	On	Start-up mode	
		Blink	Stop mode	
ERROR	Red	On/Blink	The Error LED can give indications in conjunction with the RUN and/or USB LED. See the next tables Error Indications and USB Actions Indications for details	
USB	Green	On	A USB drive is detected that contains valid action file(s). See table below, USB Actions Indications, for details	
		Blink	USB Action in progress	
BATT. LOW	Red	On	Battery is low or missing	
FORCE	Red	On	I/O Force on	
Error Indications	LED, Color & State			Indication
	RUN	ERROR	USB	Indication
		Red blink	Off	USB Action has failed – disconnect the USB drive to dismiss the error
		Red blink		HW Configuration Mismatch – the HWC in the UniLogic application does not match the Uni-I/O modules physically connected to the PLC
	Orange blink	Red blink		Application Invalid or Version Mismatch (UniLogic version is not supported by device firmware)
		Red On		Uni-I/O Error (check wiring connections)
	Orange blink	Red On		OS/Application error

USB Actions Indications	LED, Color & State			Indication
	RUN	ERROR	USB	
			Green On	USB drive detected with valid Action file(s) - press CONFIRM ⁽¹⁸⁾ to start Action or USB Action finished successfully.
			Green blink	USB Action in progress.
	Green blink		Green On	USB Action requires reset; press CONFIRM to restart system
		Red blink	Green Off	USB drive detected, but contains corrupt Action file(s)
		Red blink	Green ON	USB Action ran with error – disconnect the USB drive to dismiss the error.

Environmental	
Protection	IP20, NEMA1
Operating temperature	-20°C to 55°C (-4°F to 131°F)
Storage temperature	-30°C to 70°C (-22°F to 158°F)
Relative Humidity (RH)	5% to 95% (non-condensing)
Operating Altitude	2,000 m (6,562 ft)
Shock	IEC 60068-2-27, 15G, 11ms duration
Vibration	IEC 60068-2-6, 5Hz to 8.4Hz, 3.5mm constant amplitude, 8.4Hz to 150Hz, 1G acceleration

Dimensions		
	Weight	Size
USC-xx-TA32	0.38 Kg (0.84 lb)	As shown in the images next page

Mechanical Dimensions

Front View

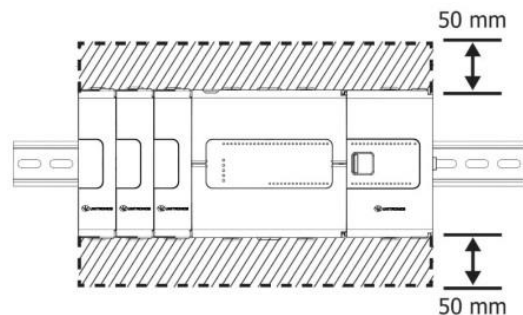
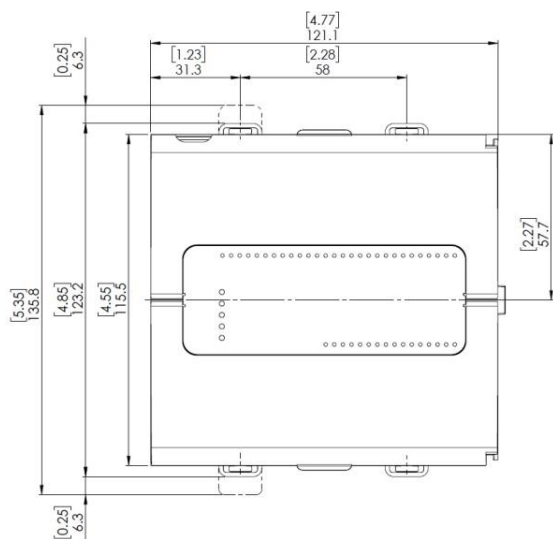

Bottom View

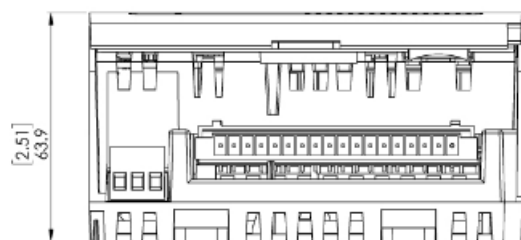

Notes:

- Four of the digital inputs (I9-I12) may be configured to function either as normal, or as high speed digital inputs, that can receive high speed pulse signals from up to two sensors or shaft encoders.
- The Local Expansion Kits comprise a Base unit, an End unit, and a connecting cable. You must plug the Base Unit into the last Uni-I/O™ module plugged into the controller.
If no module is present, plug the Base unit into the I/O Bus connector.
- Uni-COM™ CB modules plug directly into the Uni-COM Jack on the side of the controller. Uni-COM modules may be installed in the following configurations:
 - If a module comprising a serial port is plugged directly into the controller, it may be followed only by another serial module, for a total of 2.
 - If your configuration includes a CANbus module, it must be plugged directly into the controller. The CANbus module may be followed by up to two serial modules, for a total of 3.
 For more information, refer to the product's installation guide.
- When replacing the unit's battery, make sure that the new one has environmental specifications that are similar or better than the one specified in this document.
- The USB device port is used to connect the device to a PC.
- The 4-20mA input option is implemented using 0-20mA input range.
- The analog inputs measure values that are slightly higher than the nominal input range (Input Over-range).

Note that when the input overflow occurs, it is indicated in the corresponding I/O Status tag as well as by the respective input LED (see LED Indications), while the input value is registered as the maximum permissible value. For example, if the specified input range is 0 ÷ 10V, the Over-range values can reach up to 10.15V, and any input voltage higher than that will still register as 10.15V while the Overflow system tag is turned on.

- See LED Indications Table for description of the relevant indications. Note that the diagnostics results are also indicated in the system tags and can be observed through the UniApps™ or the online state of the UniLogic®.
- Step response and update time are independent of the number of channels that are used.
- The controller inherently supports 3-wire sensors.
4-wire sensors may be connected by utilizing 3 of the sensor wires; in-order to achieve the

specified performance, all sensor wires shall be of identical type and length just as with a 3-wire sensor connection.

2-wire sensors may also be connected; performance in this case will degrade because of the wires` resistance.

Refer to the controller installation guide for detailed installation instructions.

11. The controller temperature inputs measure values that are slightly higher or lower than the nominal input range (Input Over/Under-range respectively).

Note that when input Overflow, Underflow or a connection fault occurs, it is indicated in the corresponding I/O Status tag (refer to the UniLogic® help for details) as well as by the respective input LED (see LED Indications), while the input value is registered as follows:

Fault Type	Registered Value in the Input Tag
Overflow	32,767
Underflow	-32,767
Connection fault	-32,768

12. For temperature measurement, the value is represented in 0.1° units. For example, a temperature of 12.3° is represented as 123 at the Value tag.
13. The overall accuracy for thermocouples is a combination of the per-sensor specified accuracy and the thermocouple cold junction error specification.
14. Sensor connection fault check is active by default for temperature, resistance and mV measurements. This may interfere with some test equipment like RTD, thermocouple, resistance and voltage simulators and thus may induce reading errors or cause malfunction of the test equipment and/or the controller.
- In order to interoperate correctly with such equipment, you may set the Disable Fault Detection I/O tag. This will disable connection fault check for all inputs.
- Note that when this tag is set, the controller will not check, or report, connection faults; thus, the reading in such case is unpredictable.
15. Life expectancy of the relay contacts depends on the application that they are used in. The product's installation guide provides procedures for using the contacts with long cables or with inductive loads.
16. Outputs O0 and O1 can be configured as either normal digital outputs or as PWM outputs. PWM outputs specifications apply only when outputs are configured as PWM outputs.
17. The controller analog outputs are able to output values that are slightly higher or lower (if applicable) than the nominal output range (Output Over/Under-range respectively).
18. This refers to the CONFIRM button on the controller USB Actions; press it if the indication requires.

The information in this document reflects products at the date of printing. Unitronics reserves the right, subject to all applicable laws, at any time, at its sole discretion, and without notice, to discontinue or change the features, designs, materials and other specifications of its products, and to either permanently or temporarily withdraw any of the forgoing from the market.

All information in this document is provided "as is" without warranty of any kind, either expressed or implied, including but not limited to any implied warranties of merchantability, fitness for a particular purpose, or non-infringement. Unitronics assumes no responsibility for errors or omissions in the information presented in this document. In no event shall Unitronics be liable for any special, incidental, indirect or consequential damages of any kind, or any damages whatsoever arising out of or in connection with the use or performance of this information.

The tradenames, trademarks, logos and service marks presented in this document, including their design, are the property of Unitronics (1989) (R"G) Ltd. or other third parties and you are not permitted to use them without the prior written consent of Unitronics or such third party as may own them.