

Lead with Speed

Setting the pace of machine vision

IN-SIGHT 3800 SERIES



COGNEX

IN-SIGHT 3800 SERIES

All-in-one vision system meets all your vision needs

High speed, high resolution, high flexibility.
The In-Sight® 3800 has it all.

This advanced vision system provides a powerful, yet easy-to-use, solution for automated inspections. Embedded with a full set of robust rule-based tools and innovative edge learning technology, In-Sight 3800 solves a range of manufacturing applications, from defect detection and assembly verification to character reading and more.

- Run more inspections in less time.
- Improve the accuracy of your results.
- Seamlessly scale your solution.



Run more inspections in less time

Maximize throughput with high-speed processing and quick setup.

Tools running 2X faster than previous generation vision systems offer ultimate power and performance for any job

➔ PAGE 4

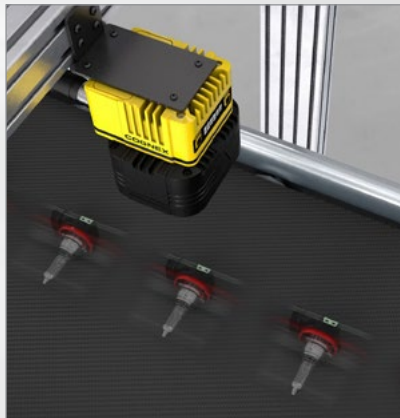

Advanced classification and OCR functionality automates a variety of tasks, from simple to complex

➔ PAGE 4

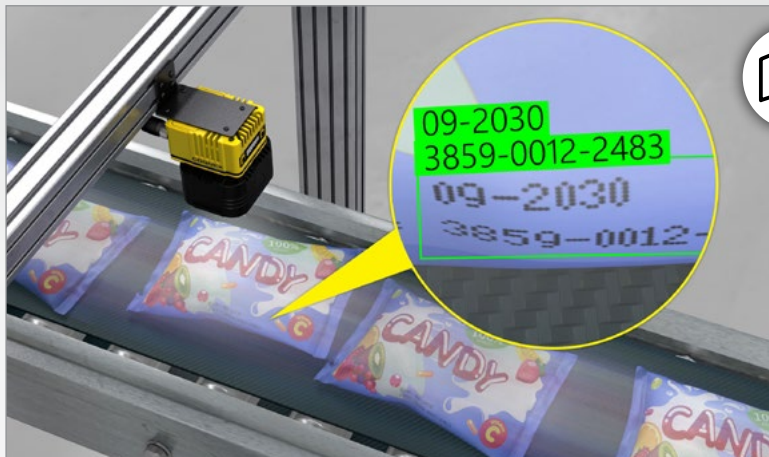

Improve the accuracy of your results

Generate high-resolution, high-contrast images that detect even the most subtle defects.

Integrated multi-color lighting accommodates a range of application requirements and operating conditions

➔ PAGE 11

Unique high-dynamic range plus (HDR+) technology optimizes image formation in a single acquisition

➔ PAGE 12

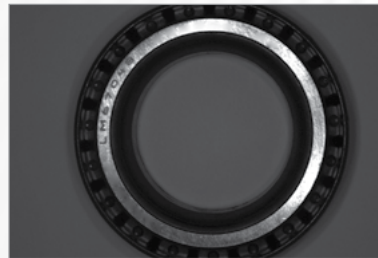

Without HDR

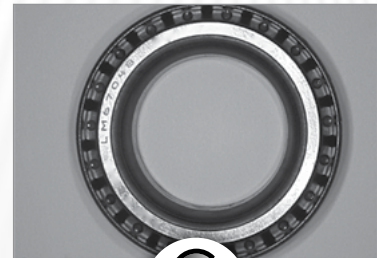

Seamlessly scale your solution

Create jobs in a common software platform that supports scalability across In-Sight products and offers both point-and-click and advanced setup options.

Robust spreadsheet-based job creation enables more control over tool parameters for complex tasks

➔ PAGE 8

Intuitive EasyBuilder® interface simplifies the training workflow for quick deployment

➔ PAGE 9

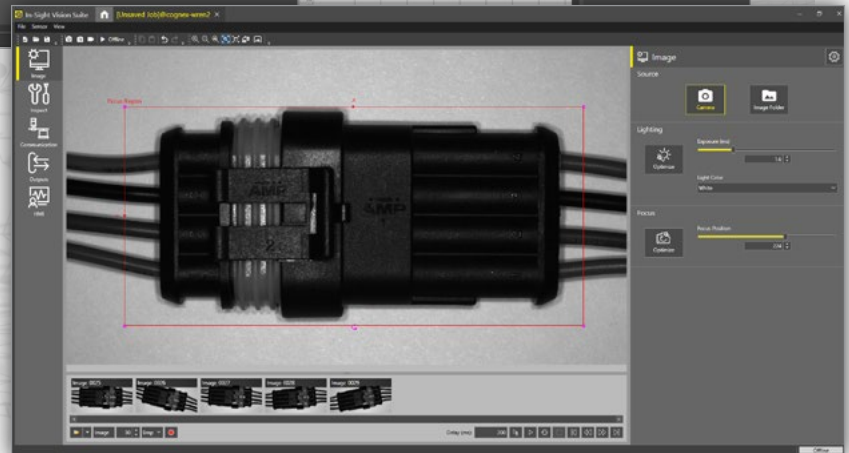
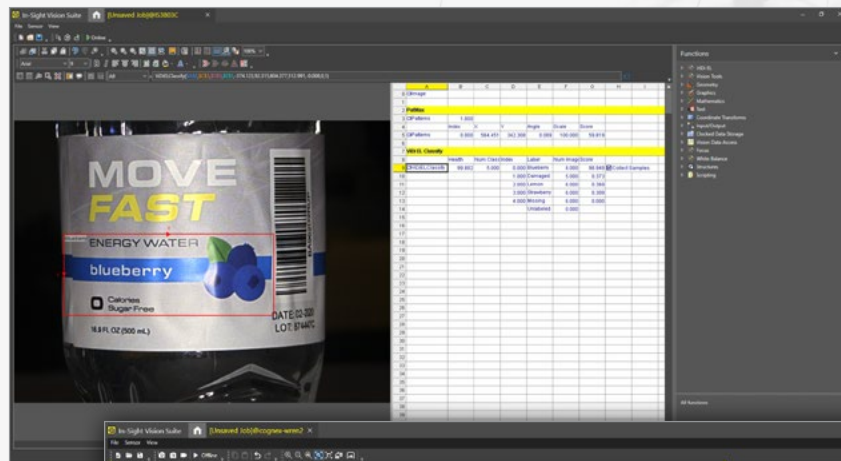

Comprehensive toolset solves tasks of varying complexity

Integrating AI and rule-based tools in a single vision system, the In-Sight 3800 addresses a wide range of error-proofing applications. The tools can be used individually for simple jobs or combined to automate more challenging problems.



2-4X FASTER
tool processing speeds than previous systems*



UP TO 2,500 PARTS/MINUTE
can be inspected with the In-Sight 3800



AI tools

The In-Sight 3800 is embedded with powerful edge learning tools that leverage AI technology to process images on device, or “at the edge” of where the data is collected, to deliver accurate results in real time.

Edge learning tools are easy-to-use and simple to deploy with example-based training and no experience needed.

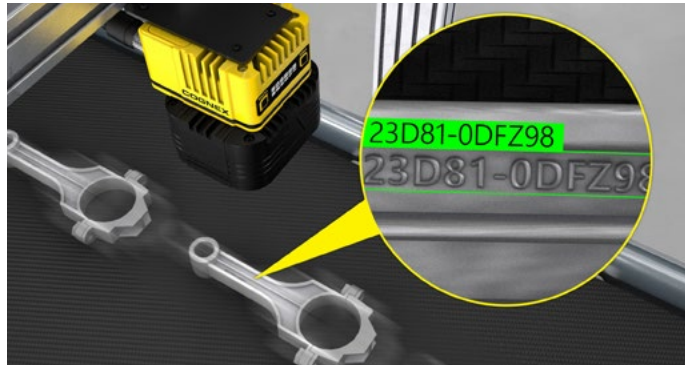
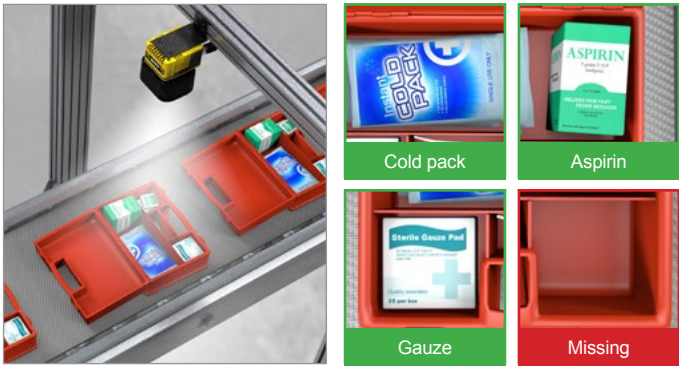

ViDi EL Classify

Go beyond the standard OK/NG output with ViDi™ EL Classify. The tool identifies and sorts parts based on multiple features or characteristics. This enables users to classify defects into different categories and correctly identify parts with variation, allowing you to automate a wider range of tasks.



ViDi EL Read

Read characters on reflective, low-contrast, and non-flat surfaces with ease. The ViDi EL Read tool deciphers a range of text, including multi-line text, using advanced optical character recognition (OCR) technology.



Training

ViDi EL tools can be trained in minutes, using as few as five to ten example images of the relevant classes or characters.

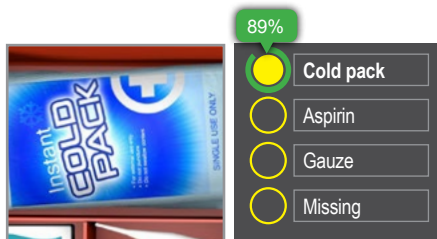
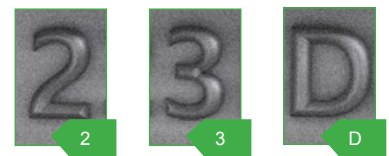

Confidence score

Get real-time, visual feedback on the accuracy of your results. The confidence score verifies whether the ViDi EL tool correctly predicted the output, leading to less manual intervention and more reliable inspections.



*Rule-based tool performance is 2x faster than In-Sight 7800/7900 series. AI tool performance is 3–4x faster than In-Sight 2800 series.



Classification examples

Consumer products: Detect presence/absence in kitted products and run multi-ROI classification

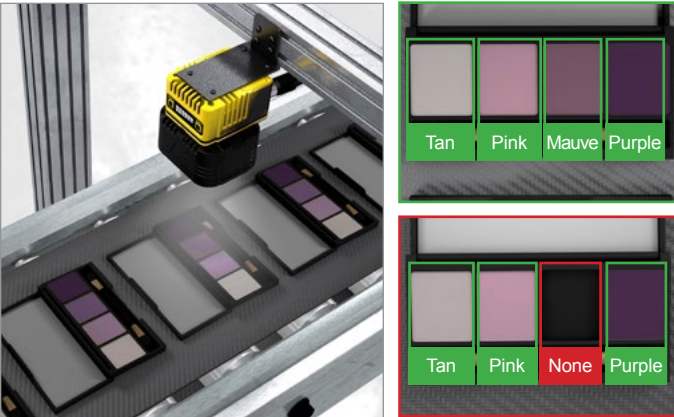

Electric vehicle (EV) batteries: Check parts for surface-level defects

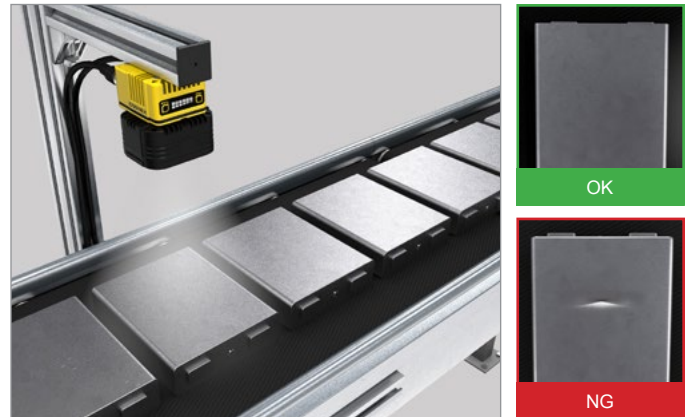

Automotive electronics: Detect presence/absence of components and classify defects

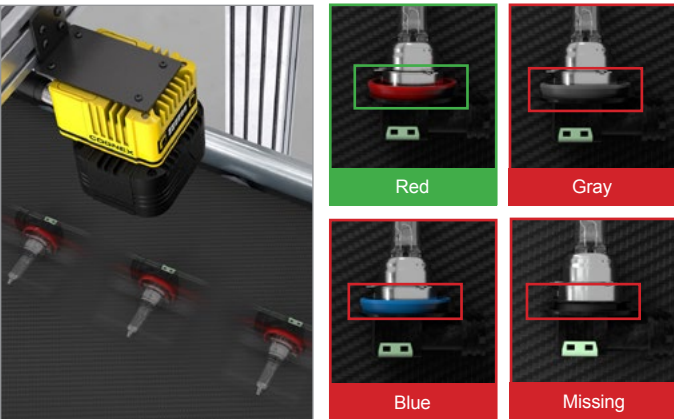

Automotive parts: Inspect for mechanical flaws

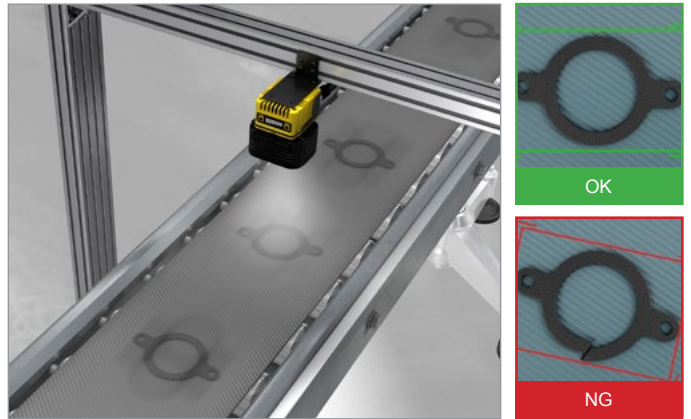

Consumer products: Classify scents or flavors on packaging

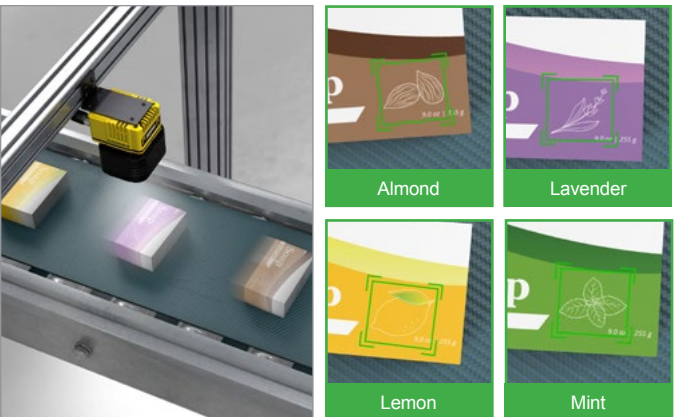

Food & beverage: Identify damaged or missing components





OCR examples

Logistics: Read multiple lines of text on different package types



Consumer product: Decipher lot codes against variable backgrounds



Automotive: Read codes on low-contrast and reflective surfaces



Pharmaceutical: Perform on-line verification at high speeds



Automotive: Decipher hard-to-read text etched on metallic surfaces

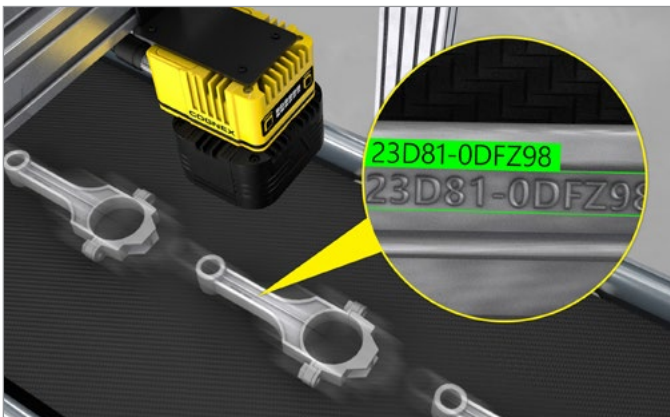

Food & beverage: Read lot codes and expiration dates on uneven surfaces

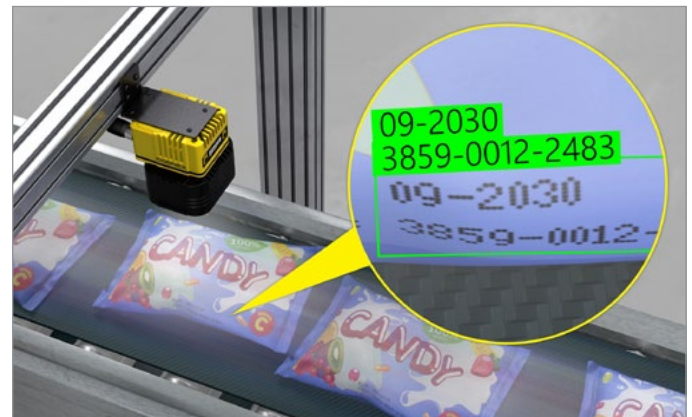



Rule-based vision tools

In-Sight 3800 is also equipped with an extensive library of industry-proven traditional vision tools that allow you to measure distance and blobs, count pixels, and patterns, read codes, guide robots, perform math and logic, and more. These tools run 2X faster on In-Sight 3800 than previous generation products, so you can solve applications more quickly and accommodate faster line speeds.

Barcode reading: Read codes on curved surfaces



Brightness: Detect presence/absence of components based on varying brightness levels

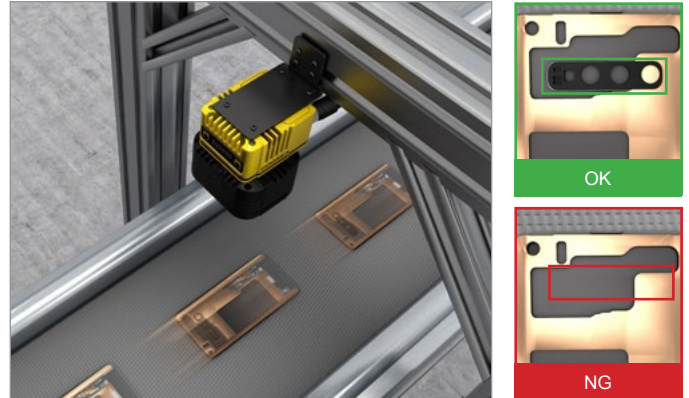

Gauging: Measure the distance between components

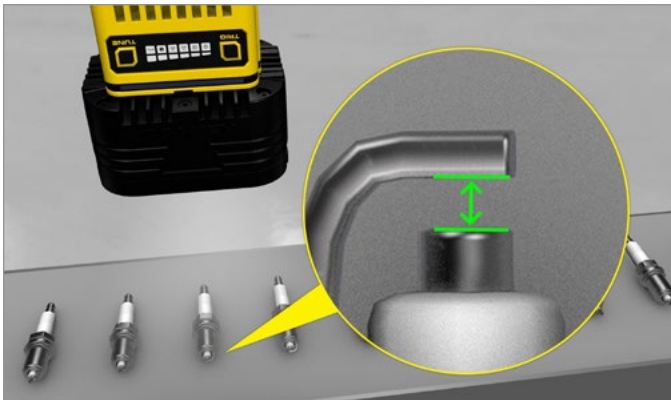

Robotic guidance: Pick and place finished products into bins



Counting: Count components to verify completeness



Code reading and OCR: Read 2D codes and text simultaneously



Common software platform offers flexible development options

In-Sight Vision Suite software is common across all In-Sight products and includes two programming environments — spreadsheet and EasyBuilder — which allows you to seamlessly scale your solution as your business needs evolve.

Spreadsheet guides users through advanced applications

The In-Sight spreadsheet interface allows you to quickly set up and run jobs without the need for programming. This robust development environment provides you with the flexibility to make critical adjustments to job parameters, so you can adapt your applications as your requirements change.

Powerful **spreadsheet** interface allows users to solve complex applications

	A	B	C	D	E	F	G	H	I
0	Image								
1									
2	PatMax								
3	Patterns	1.000							
4		Index	X	Y	Angle	Scale	Score		
5	Patterns	0.000	564.451	342.308	0.069	100.000	59.819		
6									
7	VIDI EL Classify								
8		Health	Num Class	Index	Label	Num Image	Score		
9	VIDI EL Classify	99.882	5.000	0.000	Blueberry	8.000	98.949	<input checked="" type="checkbox"/>	Collect Samples
10				1.000	Damaged	5.000	0.373		
11				2.000	Lemon	6.000	0.369		
12				3.000	Strawberry	6.000	0.309		
13				4.000	Missing	6.000	0.000		
14					Unlabeled	0.000			
15									

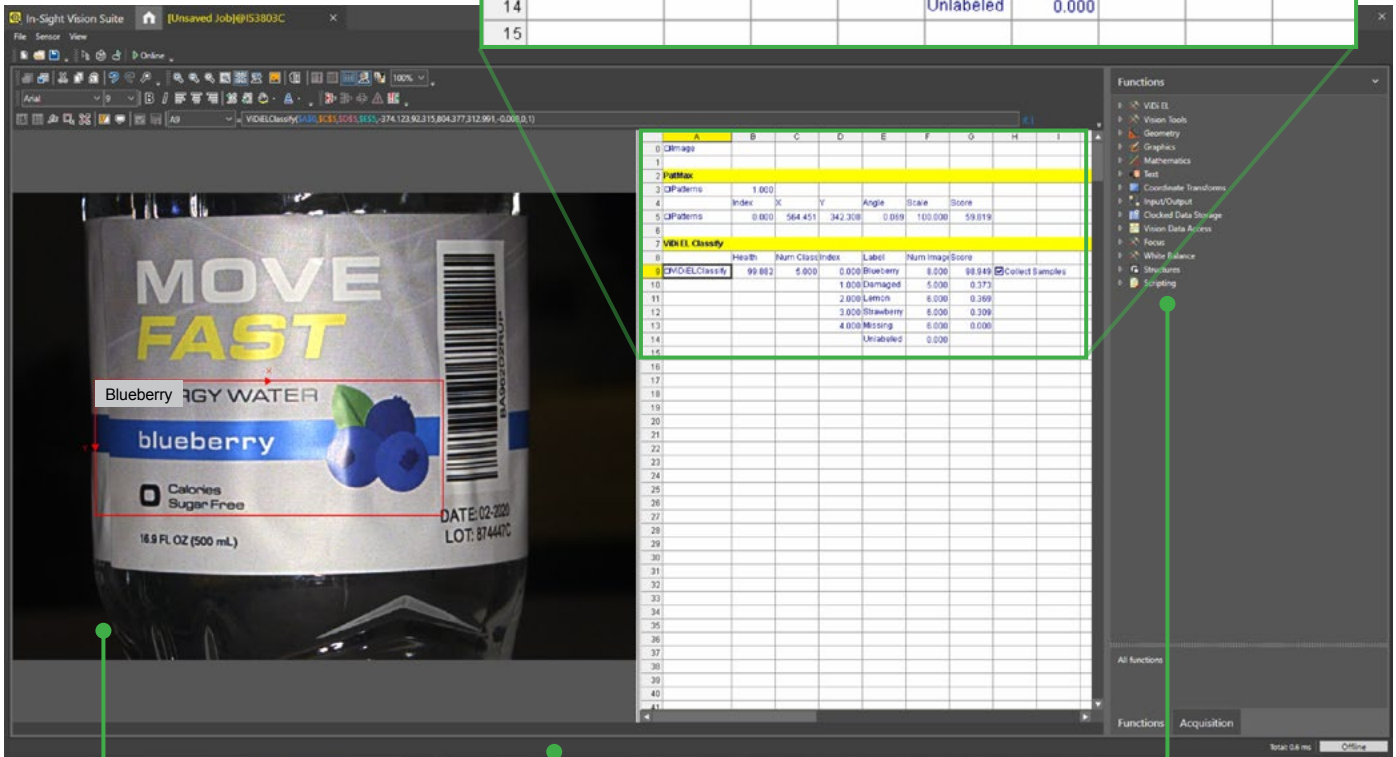

Easily review and recall files with image playback

Full I/O and communications function set streamlines factory integration

Full suite of AI- and rule-based vision tools

EasyBuilder development environment simplifies setup and delivers rapid turnaround

With its point-and-click programming, the EasyBuilder interface within In-Sight Vision Suite is ideal for developing simple or common jobs. The intuitive process guides developers step-by-step through setup — from image capture to the final result and beyond — allowing both new and experienced users to configure vision applications.

Easy **step-by-step** application setup

Image-centric **point-and-click** functionality allows users to quickly set up tools

Capture images live or upload existing libraries

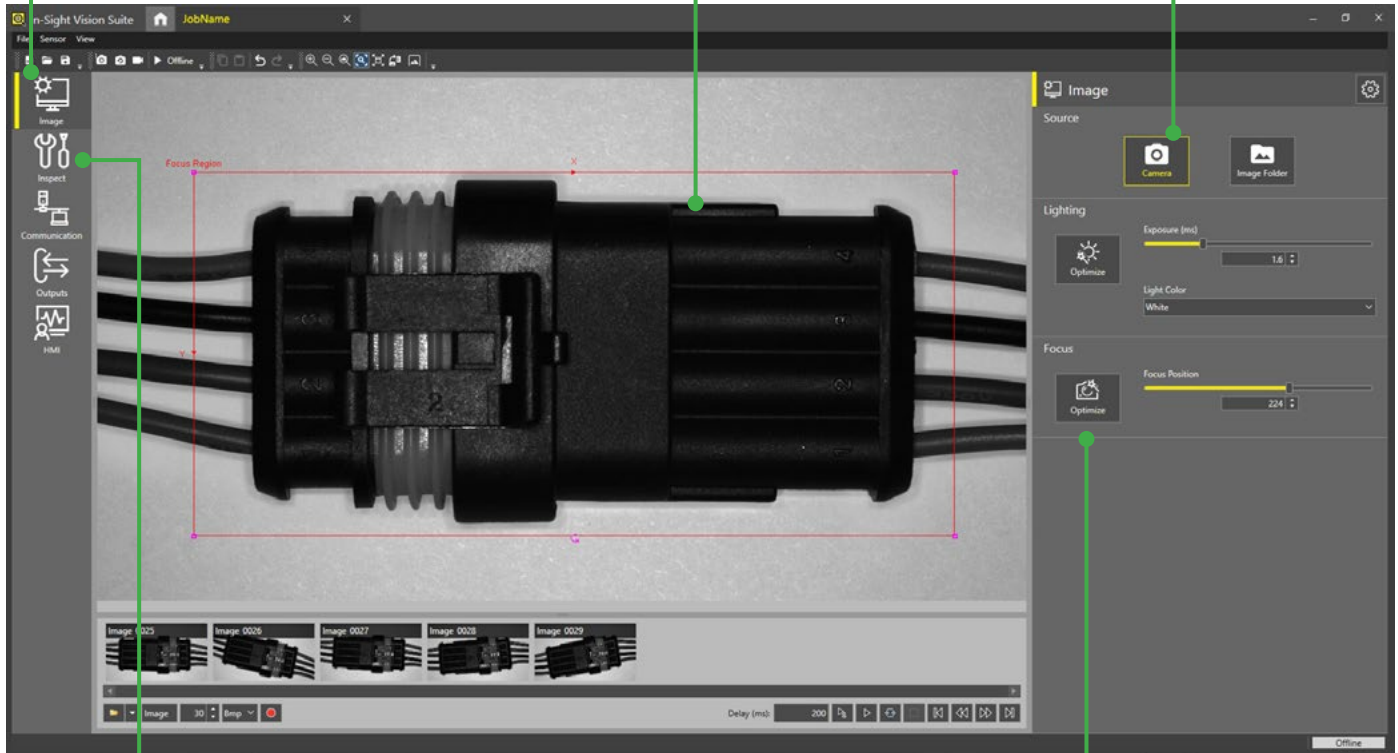

Comprehensive set of traditional rule-based vision tools and innovative edge learning tools

Fast, **2-click** image formation

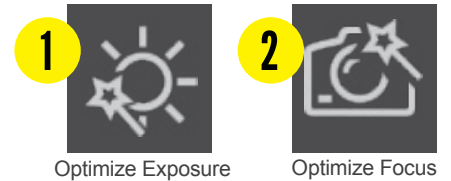

Web-based HMI offers real-time application testing and optimization

The In-Sight 3800 provides access to a web-based human-machine interface (HMI) that enables runtime visualization. From the HMI, users can view inspection results and modify setup parameters to optimize their application.

EasyView displays tags from jobs in a simplified format

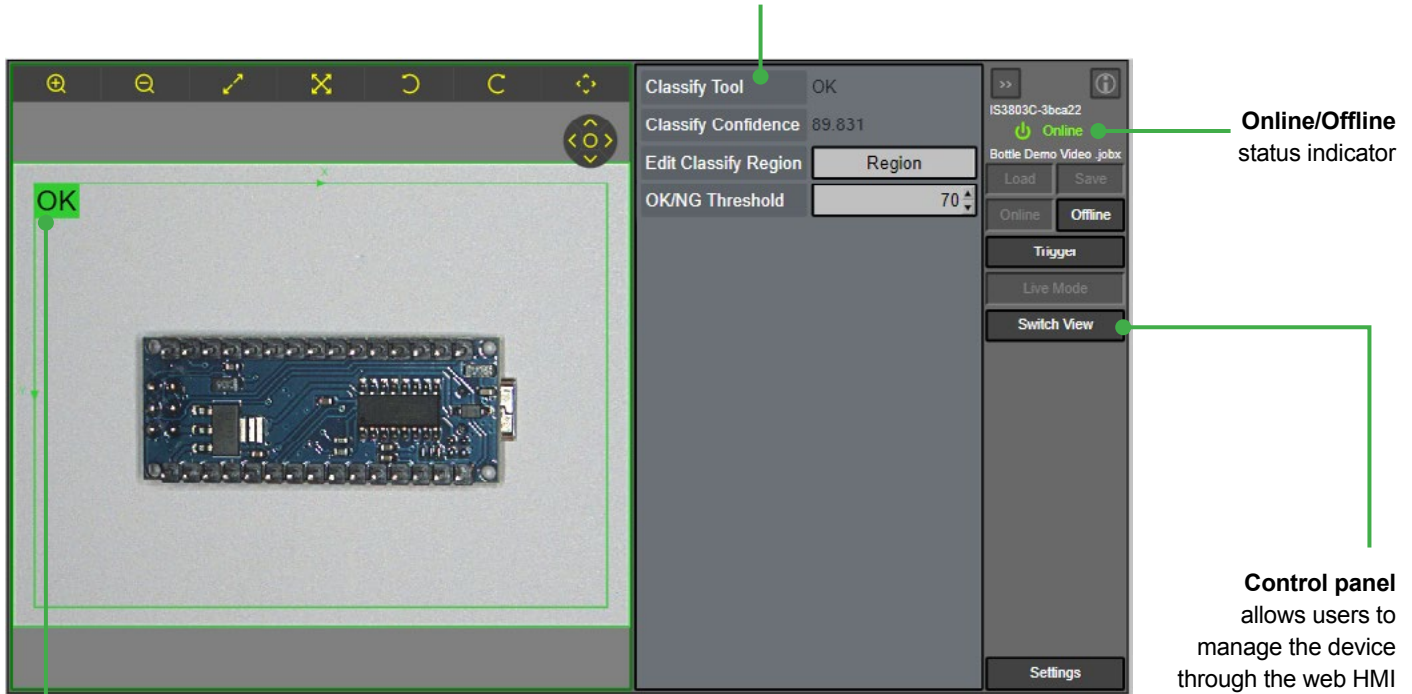

The EasyView interface features a central image of a PCB with a green bounding box and an 'OK' tag. To the right, a 'Classify Tool' panel shows 'Classify Confidence' at 89.831 and 'OK/NG Threshold' at 70. A control panel on the far right includes an 'Online' status indicator, 'Load', 'Save', 'Online', 'Offline', 'Trigger', 'Live Mode', 'Switch View', and 'Settings' buttons.

Online/Offline status indicator

Control panel allows users to manage the device through the web HMI

CustomView shows advanced settings from the spreadsheet

Overlay graphics clearly display application output

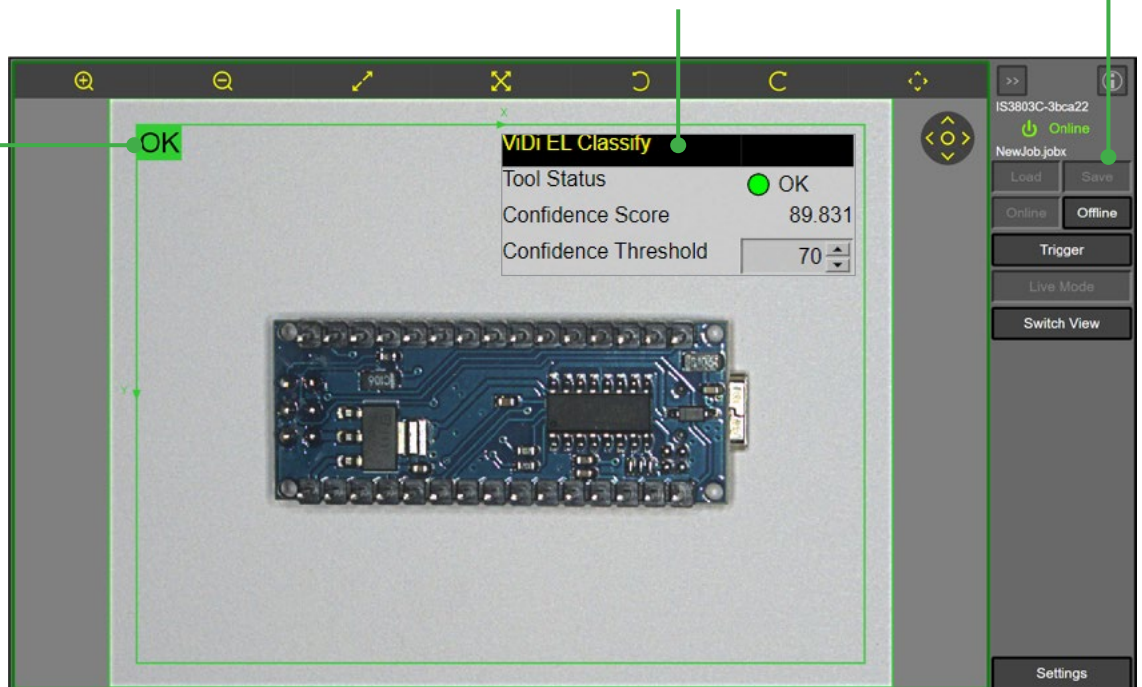

The CustomView interface shows the same PCB image with a more detailed 'VDI EL Classify' overlay. This overlay includes 'Tool Status' (OK), 'Confidence Score' (89.831), and 'Confidence Threshold' (70). The control panel on the right is similar to EasyView but includes a 'New Job' button.

Overlay graphics clearly display application output

Full-featured vision system solves wide range of applications

The In-Sight 3800 is engineered with the entire suite of innovative Cognex vision tools and convenient features that deliver fast, reliable automation.

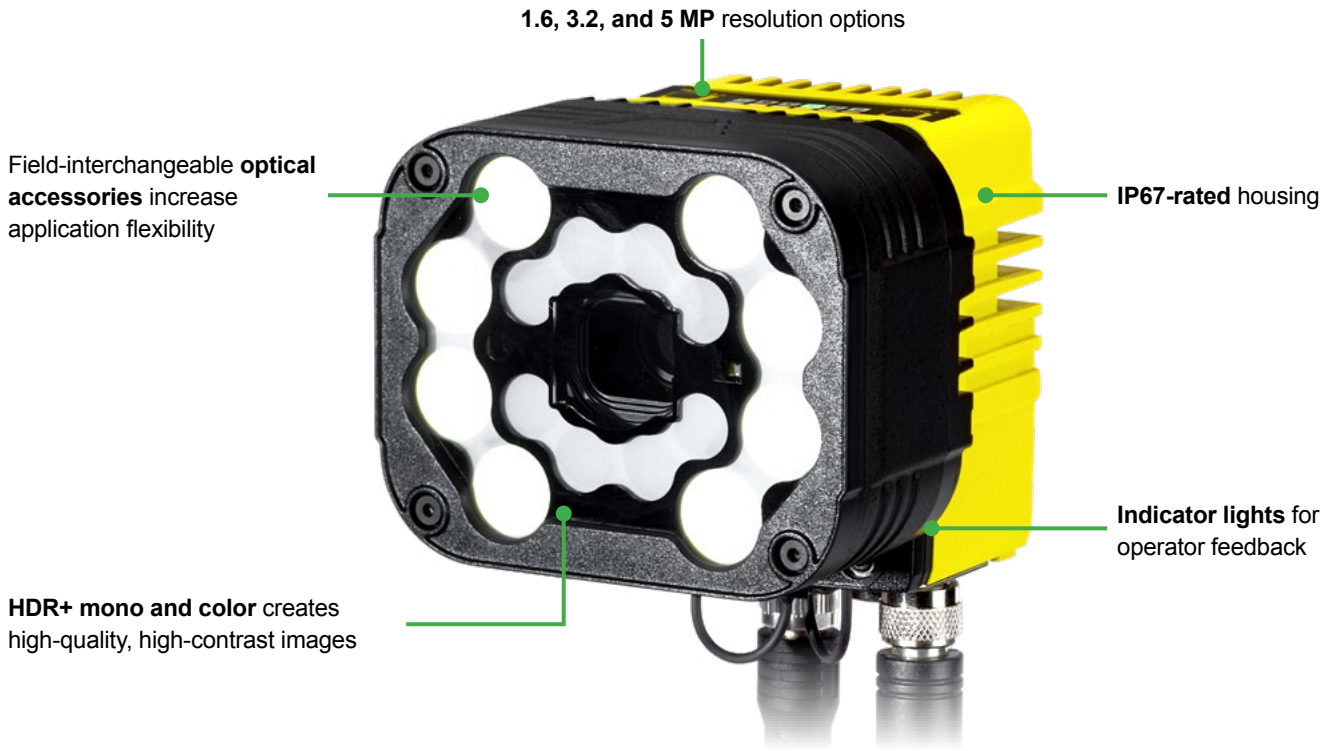

Powerful, flexible integrated lighting

Multi-color (RGBW and IR) lighting options allow you to optimize image contrast for your application, regardless of operating conditions. Simply click a button in In-Sight Vision Suite to change the light color and generate high-resolution images for more accurate inspections.



Actual part

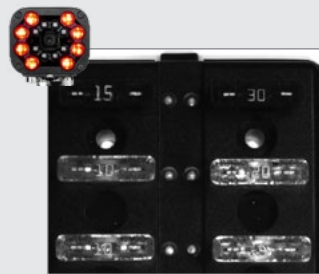

Red light:
Numbers are unclear

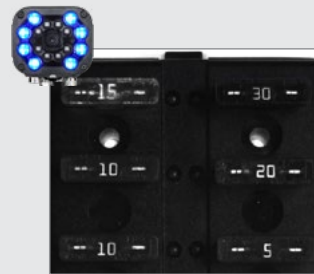

Blue light:
Numbers are clear





Innovative technology pushes the boundaries of HDR

HDR+ enhances the capabilities of HDR technology by optimizing contrast automatically. This creates a more uniformed, more detailed image in a single acquisition. Available in both monochrome and color options, HDR+ delivers higher contrast and image quality that allow you to:

- See features that were not visible before
- Reduce light intensity
- Increase depth of field

Part inspection and OCR

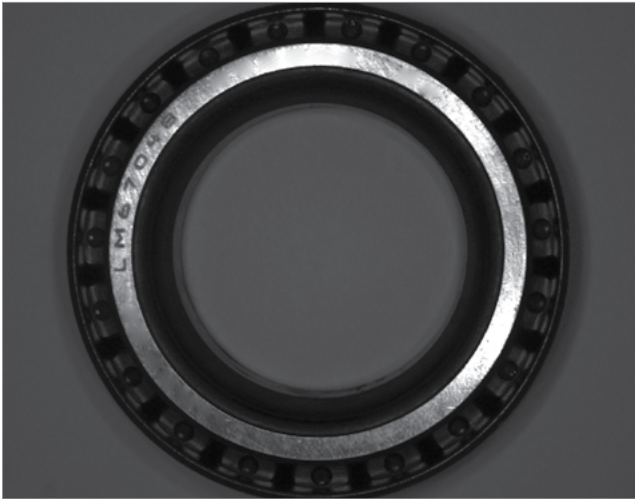

Without HDR: Embedded parts are unclear.

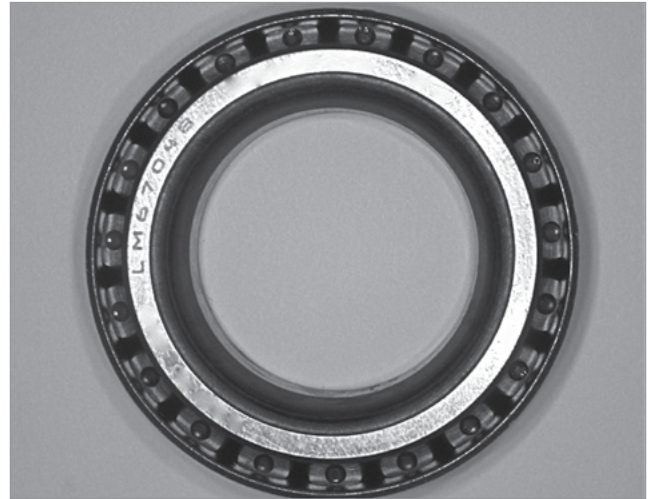

With HDR+: Serial code and bearings are both visible.

Greater depth-of-field

HDR+ reduces over- and under-exposure, providing greater depth-of-field than standard HDR technology and conventional imaging sensors.

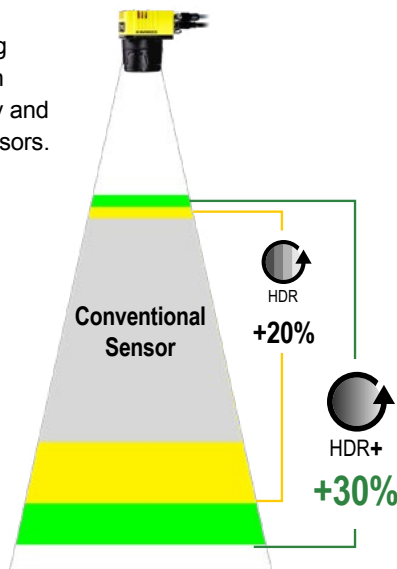

Faster line speeds

HDR+ significantly reduces exposure times, enabling you to accommodate lines up to 80% faster.

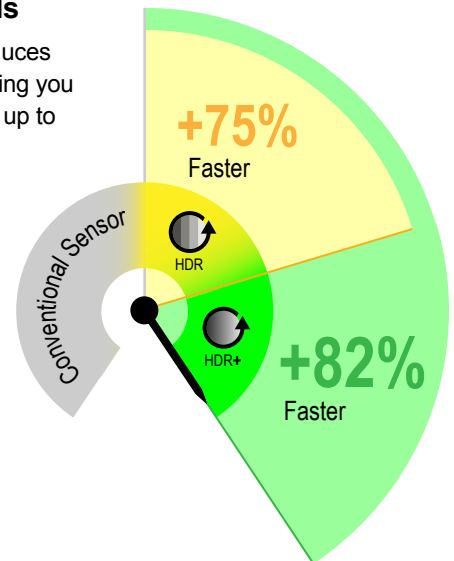

Scalable architecture for current and future needs

The In-Sight 3800 series offers a variety of accessories and modular components. This flexibility enables users to adapt to keep up with changing demands, such as new changes, faster line speeds, and higher quality standards.

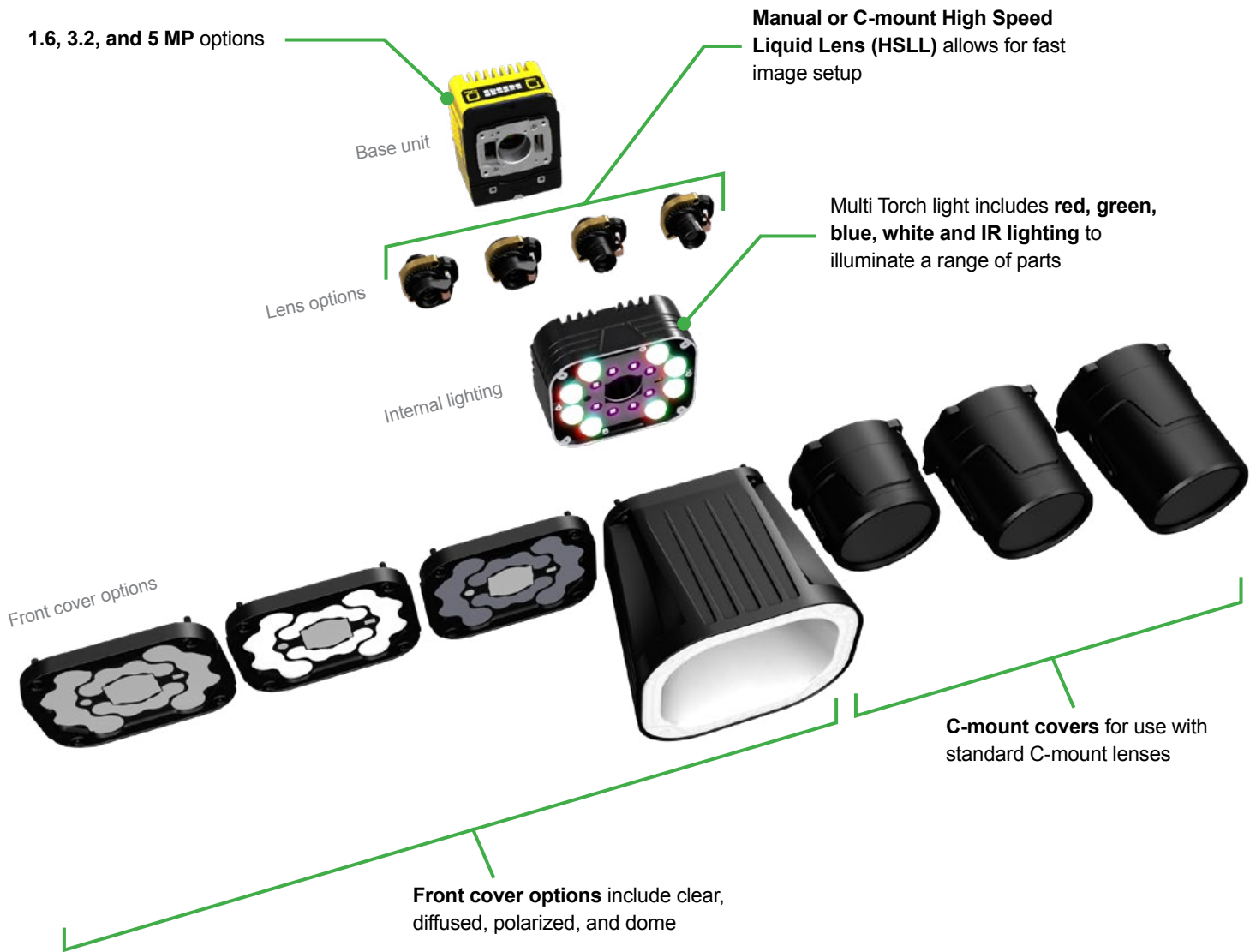

Need help configuring your system?

Watch this explainer video that walks you step-by-step through the build-up process.



www.cognex.com/in-sight-3800-buildup

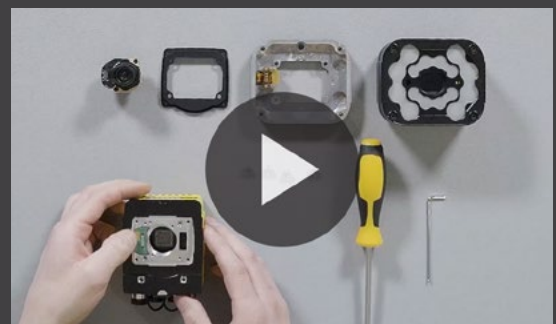

IN-SIGHT 3800 SERIES SPECIFICATIONS

Image Sensor	IS3801M	IS3801C	IS3803M	IS3803C	IS3805M	IS3805C
Bit Depth	8-bit monochrome	24-bit color	8-bit monochrome	24-bit color	8-bit monochrome	24-bit color
Frames per Second (Maximum, Full Resolution)	125 fps	52 fps	47 fps	30 fps	32 fps	21 fps
Sensor Type	1/2.3" CMOS, global shutter		1/1.8" CMOS, global shutter		2/3" CMOS, global shutter	
Sensor Properties	6.3 mm diagonal, 3.45 x 3.45 μm square pixels		8.9 mm diagonal, 3.45 x 3.45 μm square pixels		11.1 mm diagonal, 3.45 x 3.45 μm square pixels	
Maximum Image Resolution (pixels)	1440 x 1080		2048 x 1536		2448 x 2048	
Electronic Shutter Speed	19.5 μs to 200,000 μs		25.1 μs to 200,000 μs		19.1 μs to 200,000 μs	

Vision System

Memory	4 GB
Lens Type	C-Mount, Cognex High Speed Liquid Lens Autofocus, or Cognex manual focus lens (used with Multi-Torch Illumination accessory).
Trigger	1 opto-isolated, acquisition trigger input.
Discrete Inputs	1 opto-isolated, acquisition trigger input. Up to 3 general-purpose inputs when connected to the Breakout cable.
Discrete Outputs	Up to 4 high-speed outputs when connected to the Breakout cable.
Status LEDs	Pass/Fail LED and Indicator Ring, Network LED and Error LED.
High Speed Liquid Lens Lifespan	Number of Focus Cycles: 1800 M cycles
Job/Program Memory	7.2 GB non-volatile flash memory; unlimited storage via remote network device.
Image Processing Memory	512 MB SDRAM
Network Communication	2 Ethernet ports, 10/100/1000 BaseT with auto MDIX. IEEE 802.3 TCP/IP Protocol. Supports DHCP, static, and link-local IP address configuration.
Power Consumption	24 V DC \pm 10%, 2.0 A maximum.
Power Output	24 V DC at 1.0 A maximum to external light.
Material	Die-cast aluminum and zinc housing.
Finish	Painted.
Mounting	Four M3 threaded mounting holes. See Accessories for supported mounts. Pattern: 38.5 x 58.5 mm (1.52 x 2.60 in)
Weight	In-Sight 3800 with no accessories attached: 570 g (20.10 oz). With 45 mm plastic C-Mount cover (COV-380-CMNT-45): 625 g (22.0 oz.) - no lens included. With 60 mm plastic C-Mount cover (COV-380-CMNT-60): 635 g (22.4 oz.) - no lens included. With 75 mm plastic C-Mount cover (COV-380-CMNT-75): 650 g (22.9 oz.) - no lens included. With Multi-Torch Illumination, High Speed Liquid Lens (16 mm), and standard front cover: 840 g (29.6 oz.). With Multi-Torch Illumination, High Speed Liquid Lens (16 mm), and dome attachment: 970 g (34.2 oz.).
Ambient/Environment Temperature	0° C to 40° C (32° F to 122° F)
Storage Temperature	-20° C to 80° C (-4° F to 176° F)
Humidity	<95% non-condensing
Protection	IP67 with all cables properly attached (or the provided connector plug installed), the IP67-rated cover, or Multi Torch attachment properly installed.
Shock (Packaging)	IEC 60068-2-27: 18 shocks (3 shocks in each polarity in each (X, Y, Z) axis) 80 Gs (800 m/s ² at 11 ms, half-sinusoidal) with cables or cable plugs and a 150 gram or lighter lens attached.
Vibration (Shipping and Storage)	IEC 60068-2-6: vibration test in each of the three main axis for 2 hours at 10 Gs (10 to 500 Hz at 100 m/s ² / 15 mm) with cables or cable plugs and a 150 gram or lighter lens attached.
Regulations/Conformity	CE, FCC, KCC, TÜV SÜD NRTL, EU RoHS, China RoHS

Field of view diagrams*

Working distances
Units: mm (in)

**1.6 MP with
16 mm lens**

**3 MP with
16 mm lens**

**5 MP with
16 mm lens**

Minimum
150 (5.9)

62 (2.4) 46.6 (1.8)

66.8 (2.6) 49.9 (2.0)

79.2 (3.1) 66.2 (2.6)

Midpoint
500 (19.7)

207 (8.1) 155.3 (6.1)

222.5 (8.8) 113.4 (4.46)

263.9 (10.4) 220.8 (8.7)

Maximum
2000 (78.7)

828 (32.6) 621 (24.4)

890.1 (35) 665.9 (26.2)

1055.7 (41.6) 883.2 (34.8)

Working distances
Units: mm (in)

**1.6 MP with
24 mm lens**

**3 MP with
24 mm lens**

**5 MP with
24 mm lens**

Minimum
200 (7.9)

55.2 (2.2) 41.4 (1.6)

59.3 (2.3) 44.4 (1.7)

70.4 (2.8) 58.9 (2.3)

Midpoint
1000 (39.4)

276 (10.9) 207 (8.1)

296.7 (11.7) 222 (8.7)

351.9 (13.9) 294.4 (11.6)

Maximum
4000 (157.5)

1104 (43.5) 828 (32.6)

1186.8 (46.7) 887.8 (35)

1407.6 (55.4) 1177.6 (46.4)

*Field of view diagrams are based on the minimum and maximum focus distances of the High Speed Liquid Lens. If using a High Speed Liquid Lens with the Multi Torch light accessory, the system will perform best at distances between 150–500 mm (5.9–19.7 in) in terms of light intensity/uniformity.









Find the right lens for your application

The Cognex lens advisor makes it easy to select the right lens for your application. Plug in your specifications, hit "Calculate," and let the advisor take care of the rest.

cognex.com/lens-advisor

Product IDs and descriptions*

IN-SIGHT 3801								
	Product ID	Resolution	Mono/Color	Performance	Light	Lens	Cover	Toolset
	IS3801MP-00001-SA	1.6 MP	Mono	Performance	None	None	None	EB/SS ¹ , all tools
	IS3801CP-00001-SA	1.6 MP	Color	Performance	None	None	None	EB/SS, all tools
	IS3801MS-00001-SA	1.6 MP	Mono	Standard	None	None	None	EB/SS, all tools
	IS3801CS-00001-SA	1.6 MP	Color	Standard	None	None	None	EB/SS, all tools
	IS3801MP-14621-SA	1.6 MP	Mono	Performance	Multi Torch	16 mm HSSL	Diffused	EB/SS, all tools
	IS3801CP-14621-SA	1.6 MP	Color	Performance	Multi Torch	16 mm HSSL	Diffused	EB/SS, all tools
	IS3801MP-14821-SA	1.6 MP	Mono	Performance	Multi Torch	24 mm HSSL	Diffused	EB/SS, all tools
	IS3801CP-14821-SA	1.6 MP	Color	Performance	Multi Torch	24 mm HSSL	Diffused	EB/SS, all tools
IN-SIGHT 3803								
	Product ID	Resolution	Mono/Color	Performance	Light	Lens	Cover	Toolset
	IS3803MP-00001-SA	3.2 MP	Mono	Performance	None	None	None	EB/SS, all tools
	IS3803CP-00001-SA	3.2 MP	Color	Performance	None	None	None	EB/SS, all tools
	IS3803MS-00001-SA	3.2 MP	Mono	Standard	None	None	None	EB/SS, all tools
	IS3803CS-00001-SA	3.2 MP	Color	Standard	None	None	None	EB/SS, all tools
	IS3803MP-14621-SA	3.2 MP	Mono	Performance	Multi Torch	16 mm HSSL	Diffused	EB/SS, all tools
	IS3803CP-14621-SA	3.2 MP	Color	Performance	Multi Torch	16 mm HSSL	Diffused	EB/SS, all tools
	IS3803MP-14821-SA	3.2 MP	Mono	Performance	Multi Torch	24 mm HSSL	Diffused	EB/SS, all tools
	IS3803CP-14821-SA	3.2 MP	Color	Performance	Multi Torch	24 mm HSSL	Diffused	EB/SS, all tools
IN-SIGHT 3805								
	Product ID	Resolution	Mono/Color	Performance	Light	Lens	Cover	Toolset
	IS3805MP-00001-SA	5 MP	Mono	Performance	None	None	None	EB/SS, all tools
	IS3805CP-00001-SA	5 MP	Color	Performance	None	None	None	EB/SS, all tools
	IS3805MS-00001-SA	5 MP	Mono	Standard	None	None	None	EB/SS, all tools
	IS3805CS-00001-SA	5 MP	Color	Standard	None	None	None	EB/SS, all tools
	IS3805MP-14621-SA	5 MP	Mono	Performance	Multi Torch	16 mm HSSL	Diffused	EB/SS, all tools
	IS3805CP-14621-SA	5 MP	Color	Performance	Multi Torch	16 mm HSSL	Diffused	EB/SS, all tools
	IS3805MP-14821-SA	5 MP	Mono	Performance	Multi Torch	24 mm HSSL	Diffused	EB/SS, all tools
	IS3805CP-14821-SA	5 MP	Color	Performance	Multi Torch	24 mm HSSL	Diffused	EB/SS, all tools

*This table includes only the most common product models. To get information on other available models, please contact Cognex Sales at cognex.com/contact-sales.





1 EasyBuilder/Spreadsheet

Components and accessories



MULTI TORCH LIGHT

	Product ID	Description
	380-TORCH-MULTI-AF	Multi Torch Accessory Kit for autofocus lenses. Includes: Multi Torch illumination module, mount for illumination module (High Speed Liquid Lenses only), diffused cover, illumination PCB, 2 mm hex tool.
	380-TORCH-MULTI-MF	Multi Torch Accessory Kit for manual focus lenses. Includes: Multi Torch illumination module, mount for illumination module (manual focus lenses only), diffused cover, illumination PCB, 2 mm hex tool.





MULTI TORCH FRONT COVERS

	Product ID	Description
	380-TORCH-COVDIF	Multi Torch diffused front cover
	380-TORCH-COVPOL	Multi Torch cross-polarized front cover
	380-TORCH-COVCLR	Multi Torch clear front cover
	380-TORCH-DOME	Multi Torch dome attachment





BANDPASS FILTERS

	Product ID	Description
	380-TORCH-BP470	Blue bandpass filter for Multi Torch
	380-TORCH-BP635	Red bandpass filter for Multi Torch



LENSES

	Product ID	Description
	CLN-C16F8FS-HSLL	16 mm HSL
	CLN-C24F6FS-HSLL	24 mm HSL
	CLN-C16F8FS	16 mm manual focus lens
	CLN-C24F6FS	24 mm manual focus lens







LENS COVERS

	Product ID	Description
	COV-380-CMNT-45	45 mm plastic lens cover
	COV-380-CMNT-60	60 mm plastic lens cover
	COV-380-CMNT-75	75 mm plastic lens cover
	COV-7000-CMNT-LGX	30 mm lens cover extender

MOUNTING BRACKETS

	Product ID	Description
	BKT-INS-01	Mounting bracket with M3, M4 and 1/4 - 20 mounting holes
	ISB-7000-7K	Converter mounting bracket with M3 socket head screws/wrench
	ISB-7000-5K	Converter mounting bracket with Phillips flat head M3 screws and M4 screws

CABLES

	Product ID	Description
	IVSL-5PM12-J300 IVSL-5PM12-J500 IVSL-5PM12-J1000 IVSL-5PM12-J2000	External light cable, yellow (300 mm, 500 mm, 1000 mm, 2000 mm)
	IVSL-M12-NSB-300 IVSL-M12-NSB-1000 IVSL-M12-NSB-2000	External light cable, black (300 mm, 1000 mm, 2000 mm)
	CCB-M12LTF-05 CCB-M12LTF-100 CCB-M12LTF-200 CCB-M12LTF-500	External light cable, gray (0.5 m, 1 m, 2 m, 5 m)
	ICQ-CB-0.5-IFL-M12	Black M12 to M12 cable with a small in-line capacitor (2 m)
	CCB-84901-2001-02 CCB-84901-2001-05 CCB-84901-2001-10 CCB-84901-2001-15 CCB-84901-2001-30	Ethernet cable, X-coded M12-8 to RJ-45 (2 m, 5 m, 10 m, 15 m, 30 m)
	CCB-84901-2RBT-02 CCB-84901-2RBT-05 CCB-84901-2RBT-10	Ethernet cable, X-coded M12-8 to RJ-45 (2 m, 5 m, 10 m)
	CCB-PWRIO-05 CCB-PWRIO-10 CCB-PWRIO-15	Breakout cable, M12-12 to flying lead (5 m, 10 m, 15 m)

Dimensions

Units: mm, [in]

In-Sight 3800 base unit

[Download CAD files](#)

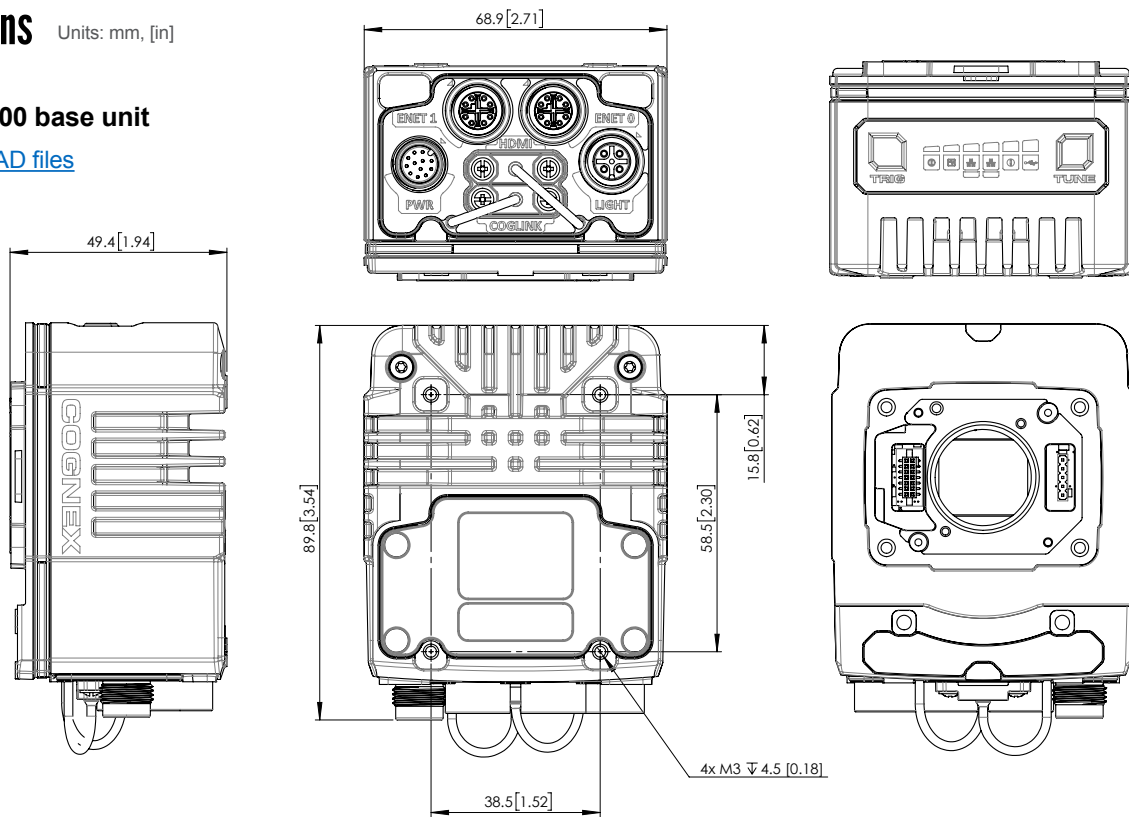

In-Sight 3800 with Multi Torch

[Download CAD files](#)

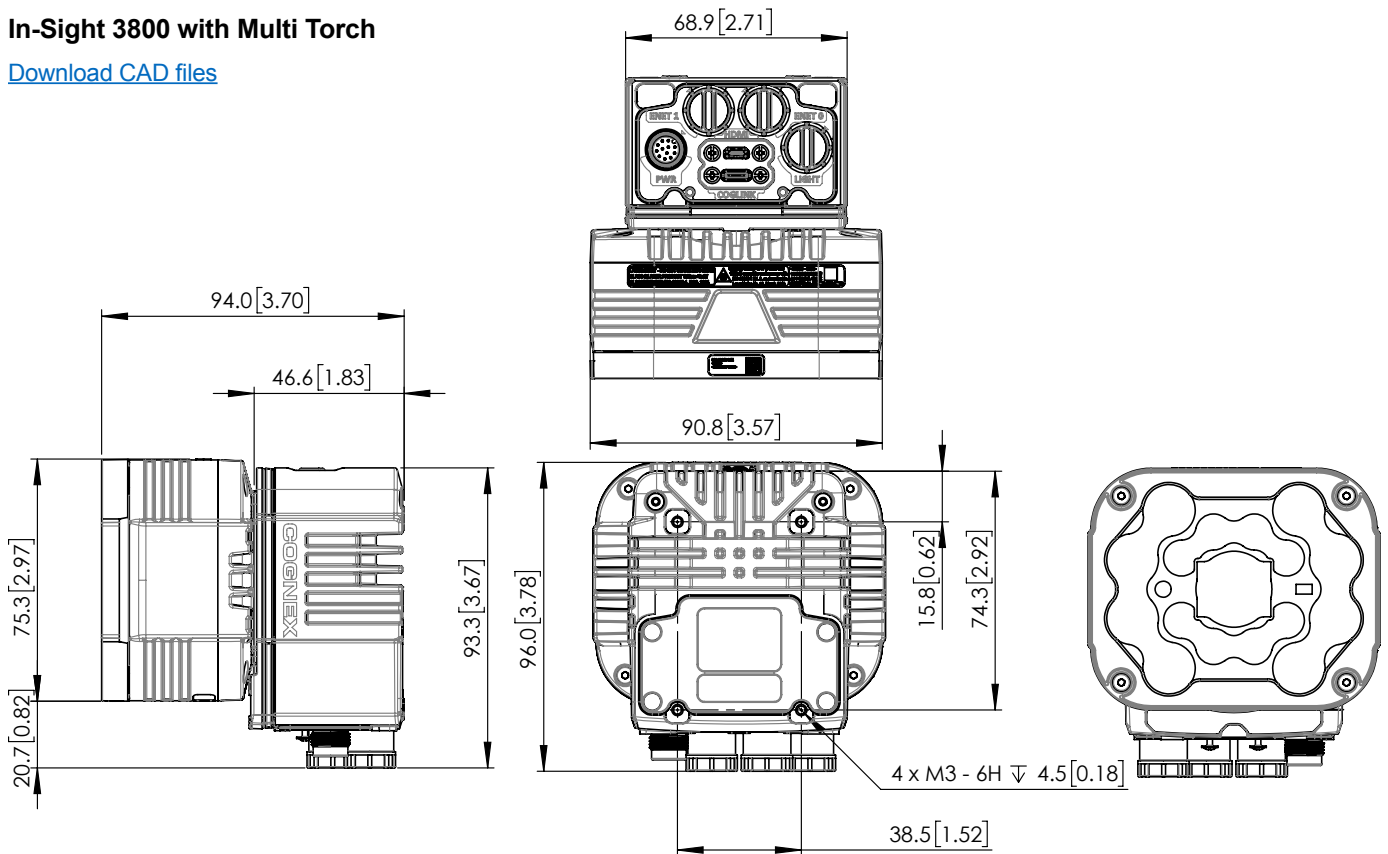

In-Sight 3800 with Dome

[Download CAD files](#)

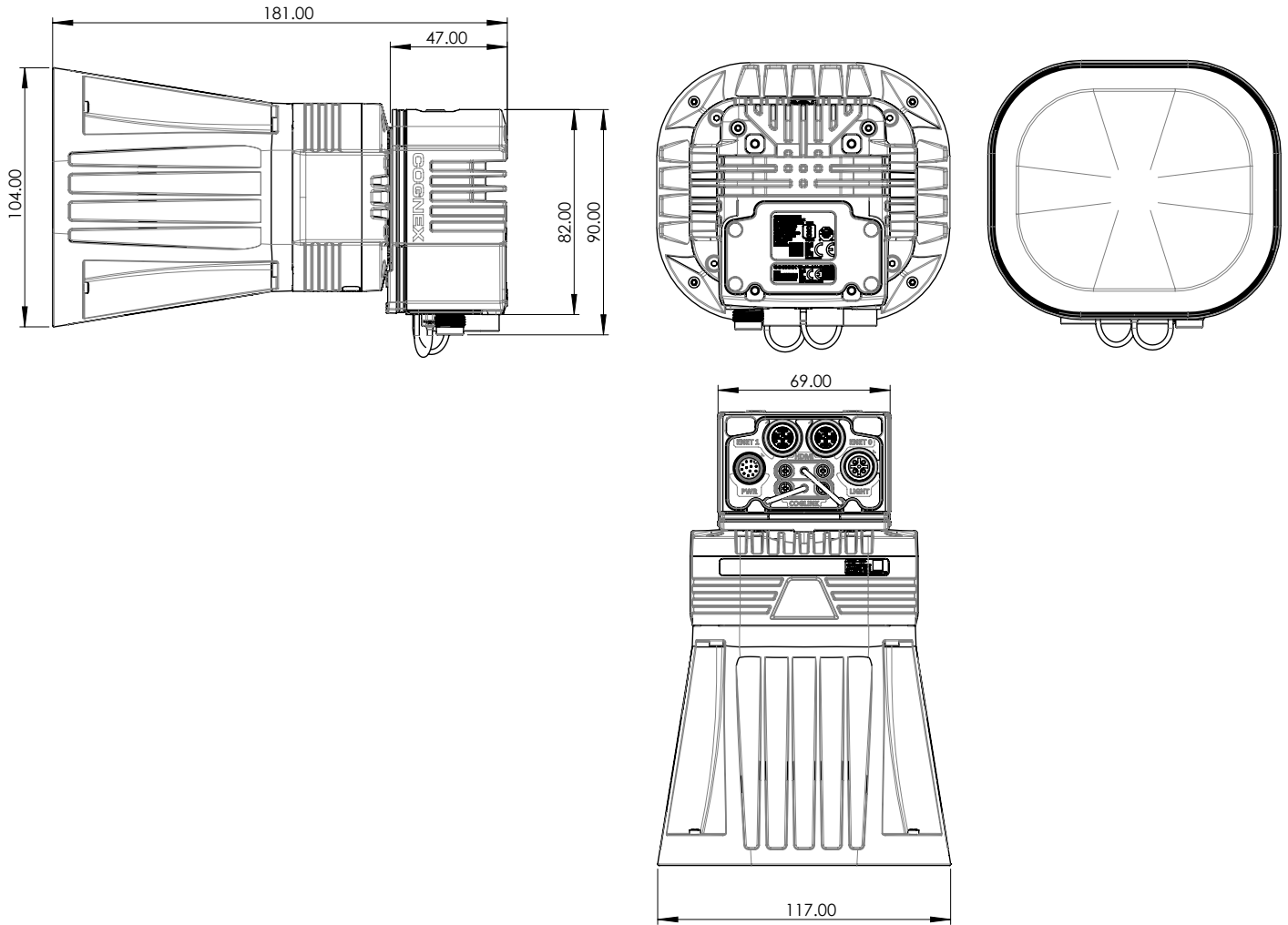

In-Sight 3800 with C-mount

45 mm C-mount cover

[Download CAD files](#)

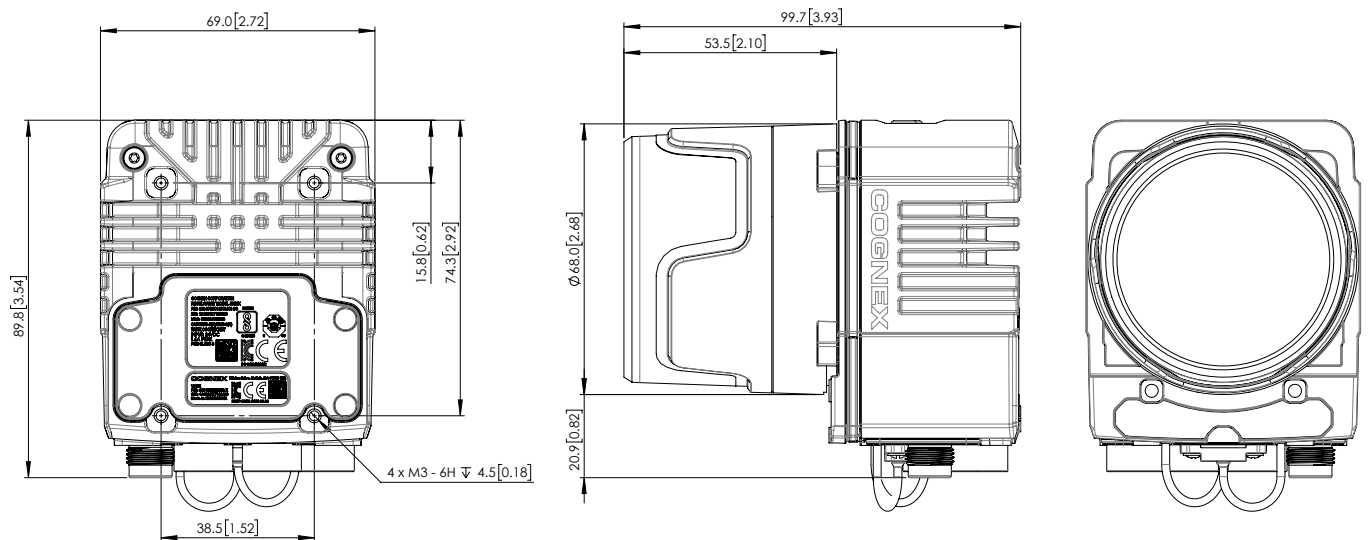

60 mm C-mount cover

[Download CAD files](#)

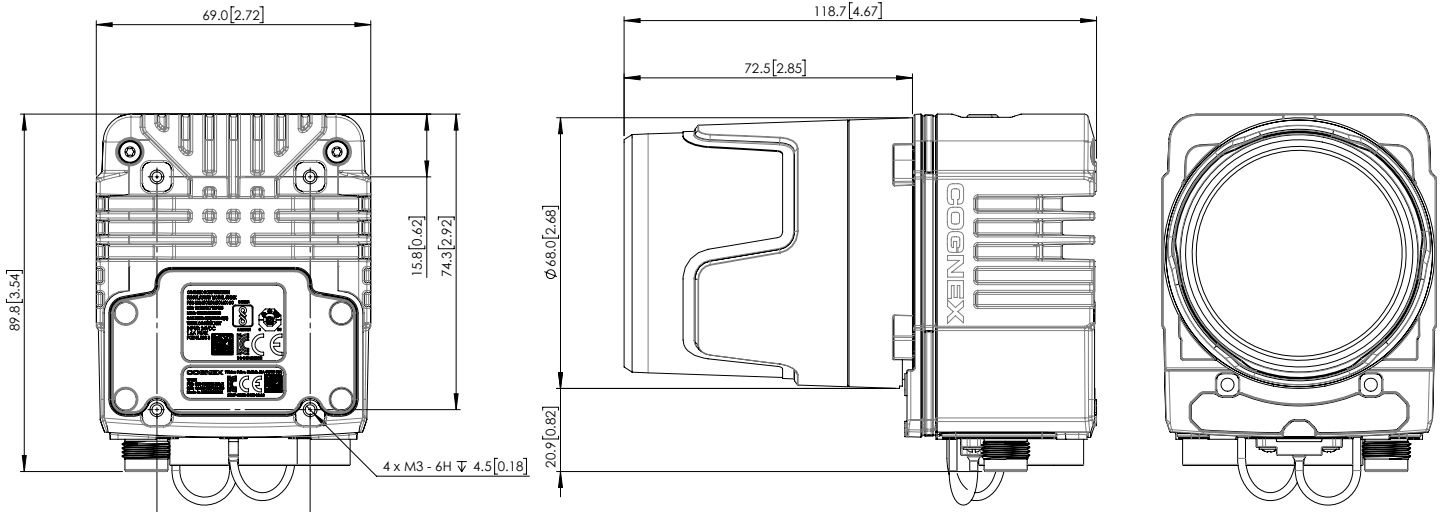

75 mm C-mount cover

[Download CAD files](#)

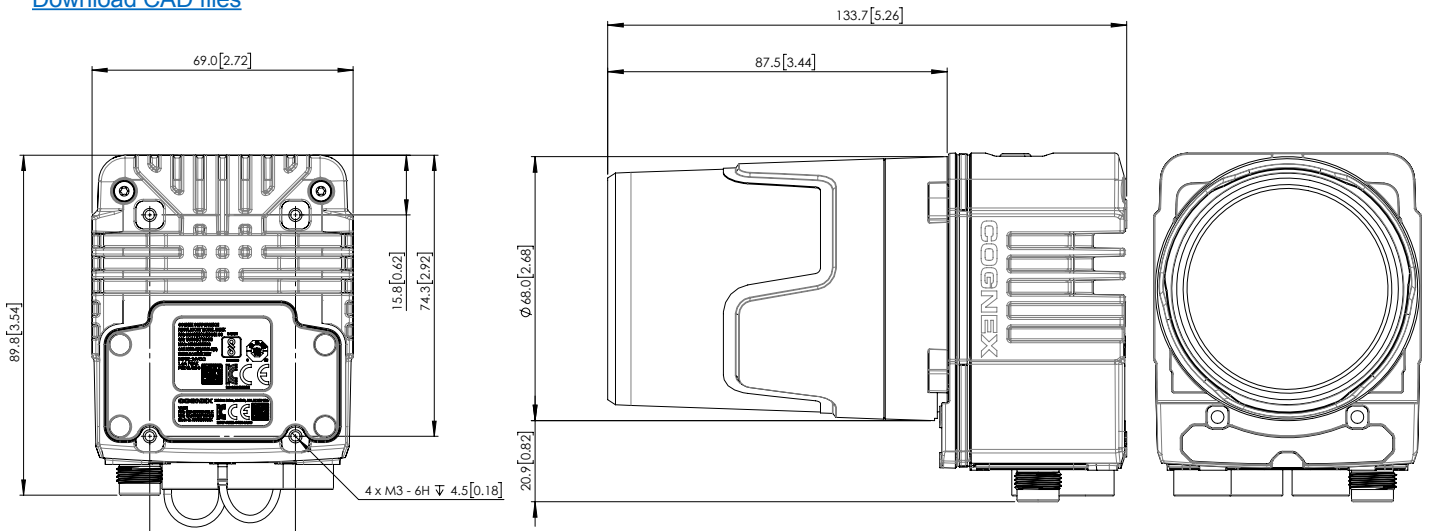

Cable bend radius

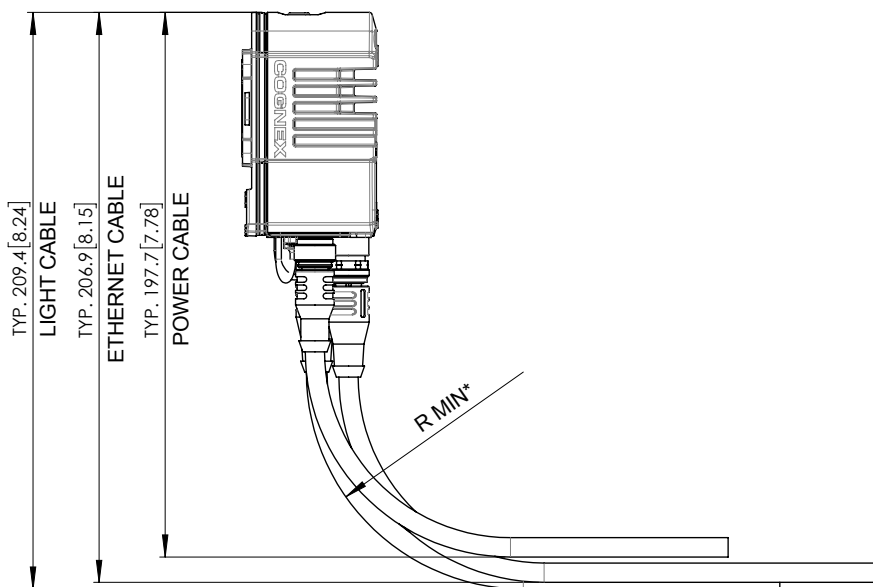

*R MIN = 10X CABLE DIAMETER

TYPICAL:
 POWER CABLE Ø7.1 [0.28]
 ETHERNET CABLE Ø7.1 [0.28]
 LIGHT CABLE Ø7.5 [0.3]

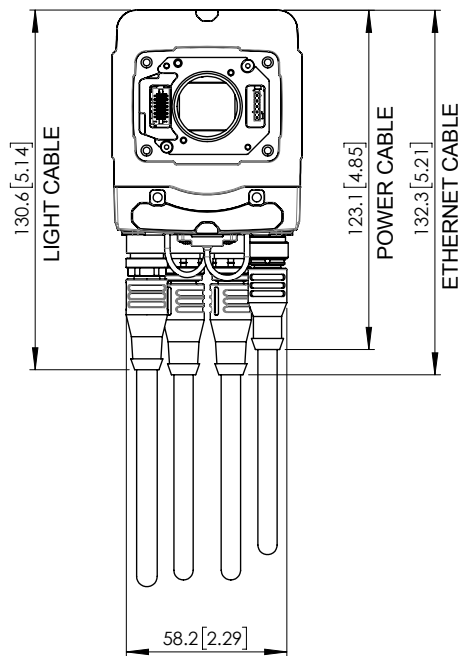

COGNEX

Companies around the world rely on Cognex vision and barcode reading solutions to optimize quality, drive down costs and control traceability.

Corporate Headquarters One Vision Drive Natick, MA 01760 USA

Regional Sales Offices

Americas

North America +1 844 999 2469
 Brazil +55 11 4210 3919
 Mexico +800 733 4116

Europe

Austria +43 800 28 16 32
 Belgium +32 289 370 75
 Czechia +420 800 023 519
 France +33 1 76 54 93 18
 Germany +49 721 958 8052

Hungary +36 800 80291
 Ireland +353 21 421 7500
 Italy +39 02 3057 8196
 Netherlands +31 207 941 398
 Poland +48 717 121 086
 Romania +40 741 041 272
 Spain +34 93 299 28 14
 Sweden +46 21 14 55 88
 Switzerland +41 445 788 877
 Turkey +90 216 900 1696
 United Kingdom +44 121 29 65 163

Asia-Pacific

Australia +61 2 7202 6910
 China +86 21 2279 9455
 India +91 7305 040397
 Indonesia +62 21 80602011
 Japan +81 3 5977 5400
 Korea +82 2 539 9047
 Malaysia +6019 916 5532
 New Zealand +64 9 802 0555
 Singapore +65 3158 3322
 Taiwan +886 02 7703 2848
 Thailand +66 6 3230 9998
 Vietnam +84 98 2405167

© Copyright 2023, Cognex Corporation.
 All information in this document is subject to change without notice. All Rights Reserved. Cognex, In-Sight, and EasyBuilder are registered trademarks of Cognex Corporation. ViDi is a trademark of Cognex Corporation. All other trademarks are property of their respective owners. Lit. No. IS3800DS-04-2023

www.cognex.com