



CD Automation S.r.l.

Via Picasso 34/36 - 20025 - Legnano (MI) - ITALY

Tel +39 0331 577479 - Fax +39 0331 579479

E-Mail: info@cdautomation.com - WEB: www.cdautomation.com

1 IMPORTANT WARNINGS FOR SAFETY	6
2 NOTE	7
3 INTRODUCTION	8
4 ADVANTAGES COMPARED WITH ANALOG THYRISTOR UNIT	8
5 SOFTWARE CONFIGURATOR CDA THYRISTOR CONFIGURATOR SOFTWARE	9
6 QUICK START	10
7 BASIC CONNECTIONS AND SIZING	11
8 IDENTIFICATION AND ORDER CODE	12
8.1 Identification of the unit	12
8.2 Order Code	13
9 TECHNICAL SPECIFICATIONS	14
9.1 General features:	14
9.2 Input features:	14
9.3 Output features(power device):	14
10 INSTALLATION	15
10.1 Environmental installation conditions	15
10.2 Derating Curve	15
10.3 Dimensions and Weight	16
10.4 Fixing holes	16
11 WIRING INSTRUCTIONS	17
11.1 Access to L1-L3 and T1-T3 terminal Screw	18
11.2 Command Terminals	19
11.2.1 Terminal block M2	19
11.2.2 Terminal block M1	19
11.2.3 Terminal block M3	19
11.2.4 Terminal block M4	19
11.3 Schematic	20
11.4 Connection Diagram for 3 phases (control on 2 phases)	22
12 CONTROL PANEL	23
12.1 Scroll the parameters	24
12.2 Operator Menu <i>oPEr</i>	25
12.3 Setup Menu <i>SEt</i>	28
12.4 Hardware Menu <i>HArd</i>	31
12.5 Control Panel Led	33
12.6 Displayed Alarms	33
13 INPUT OUTPUT SIGNAL	34
13.1 Digital Input	34
13.1.1 Start/Stop (Terminal 3 of M2)	34
13.1.2 Configurable Input (Terminal 4 of M2)	34
13.2 Digital Output terminal (terminal 14-15-16 of M1)	34
13.3 Analog Input	34

14 HEATER BREAK ALARM AND SCR SHORT CIRCUIT (HB OPTION)	35
14.1 Heater break Calibration procedure	35
14.2 HB alarm contact (digital output)	35
15 FIRING TYPE	36
15.1 Zero Crossing (ZC - \overline{Zr})	36
15.2 Burst Firing (BF - \overline{bF})	36
16 FEED-BACK TYPE	37
17 ELECTRONIC BOARDS	38
17.1 How to access	38
17.2 Supply the Electronic Board	39
17.3 Analog Inputs Configuration	40
17.3.1 Primary Input calibration procedure	40
18 PG CONNECTOR	41
19 RS485 SERIAL PORT	42
20 INTERNAL FUSE	43
20.1 Fuses Replacement	43
21 MAINTENANCE	44
21.1 Trouble Shooting	44
21.2 Warranty condition	44

CD Automation s.r.l.**Controllers, Drives & Automation**

Via Picasso, 34/36 - 20025 Legnano (MI)- Italia

P.I. 08925720156 -Tel. (0331) 577479 - Fax (0331) 579479

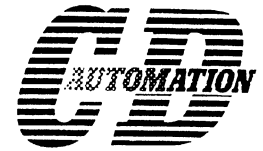
Internet : www.cdautomation.com - E-MAIL: info@cdautomation.com

Dichiarazione di Conformità **CE** **CE** Declaration of Conformity

PRODUTTORE:

PRODUCT MANUFACTURER:

CD Automation S.R.L.

INDIRIZZO:

ADDRESS:

Via Pablo Picasso 34//36
20025 Legnano (Mi)
Italia

**Dichiara che il prodotto:
 Declare that the product:**

Revom, 2ph da 30 a 40A

SODDISFA I REQUISITI DELLA NORMA :

Specifica di sicurezza	EN60947-1	:2008
	EN60947-4-3:2001	
Specifica sulle emissioni	EN60947-4-3:2000	
Specifica sulle Immunità	EN60947-4-3:2000	

FULFILS THE REQUIREMENTS OF THE STANDARD:

Electrical safety Standard	EN60947-1	:2008
	EN60947-4-3:2001	
Generic Emission standard	EN60947-4-3:2000	
Generic Immunity standard	EN60947-4-3:2000	

CDAutomation dichiara che I prodotti sopra menzionati sono conformi alla direttiva
 CDAutomation declares that The products above mentioned they am conforming to the directive
EMC 2004/108/CEE e alla direttiva Bassa Tensione (low Voltage) **2006/95/CEE**

DESCIZIONE DEL PRODOTTO:
PRODUCT DESCRIPTION:Unità di controllo potenza elettrica
Electric power controllUTILIZZO:
SCOPE OF APPLICATION:Controllo processi termici
Thermal controll processData di emissione: 20/04/2010
Issued on: 20/04/2010Amministratore Unico e
Legale Rappresentante
Claudio Brizzi

A handwritten signature in black ink, appearing to read 'C. Brizzi'.

1 Important warnings for safety

This chapter contains important information for the safety. The not observance of these instructions may result in serious personal injury or death and can cause serious damages to the Thyristor unit and to the components system included.

The installation should be performed by qualified persons.



The Thyristor unit are integral part of industrial equipments. When it is supply, the Thyristor unit is subject to dangerous tensions.

- Don't remove the protection Cover.
- Don't use these unit in aerospace applications and/ or nuclear.



The nominal current corresponds to use at temperature not superior to 45°C.

- The Thyristor unit must be mounted in vertical position and without obstruction above and below to allow a good flow ventilation.
- The hot air of one thyristor unit must not invest the unit positioned above.
- For side by side placed leave a space of 15mm between the unit.



A suitable device must ensure that the unit can be electrically isolated from the supply, this allows the qualified people to work in safety.



Protection (Protection, Protezione)

The unit have IP20 protection rating as defined by the specific international. Is necessary consider the place of installation.



Earth (Terre, Messa a terra)

For safety, the Thyristor unit with isolated heat-sink must be connected to earth. Earth impedance should be correspondent to local earth regulation. Periodically the earth efficiency should be inspected.



Electronic supply (Alimentation électronique, Alimentazione elettronica)

The electronic circuit of the Thyristor unit must be supplied by dedicated voltage for all electronic circuits and not in parallel with coil contactors, solenoids and other.

It's recommended to use a shielded transformer.



Electric Shock Hazard (Risque de choc électrique, Rischi di scosse elettriche)

When the Thyristor unit is energized, after the power supply is shut off, wait least a minute for allow the discharge of the internal capacitors where there is a dangerous tension. Before working, make sure that:

- Only authorized personnel must perform maintenance, inspection, and replacement operations.
- The authorized personnel must read this manual before to have access to the unit.
- Unqualified People don't perform jobs on the same unit or in the immediate vicinities.



Important warnings (Attention, Avvertenze importanti)

During the operations with units under tension, local regulations regarding electrical installation should be rigidly observed:

- Respect the internal safety rules.
- Don't bend components to maintain insulation distances.
- Protect the units from high temperature humidity and vibrations.
- Don't touch components to prevent electrostatic discharges on them.
- Verify that the size is in line with real needs.
- To measure voltage current etc. on unit, remove rings and other jewels from fingers and hands.
- Authorized personnel that work on thyristor unit under power supply voltage must be on insulated board

This listing does not represent a complete enumeration of all necessary safety cautions.



Electromagnetic compatibility

(Compatibilità elettromagnetica, Compatibilità elettromagnetica)

Our thyristor units have an excellent immunity to electromagnetic interferences if all suggestions contained in this manual are respected. In respect to a good Engineering practice, all inductive loads like solenoids contactor coils should have a filter in parallel.



Emissions (Emission, Emissioni)

All solid-state power controllers emit a certain amount of radio-frequency energy because of the fast switching of the power devices.

The CD Automation's Thyristor unit are in accord with the EMC norms, CE mark.

In most installations, near by electronic systems will experience no difficulty with interference. If very sensitive electronic measuring equipment or low-frequency radio receivers are to be used near the unit, some special precautions may be required. These may include the installation of a line supply filter and the use of screened (shielded) output cable to the load.

2 Note



Warning: This icon is present in all the operational procedures where the Improper operation may result in serious personal injury or death



Caution: This icon is present in all the operational procedures where the Improper operation can cause damage for the Thyristor unit.

CD Automation reserves the right to modify the own products and this manual without any advise.



3 Introduction

A thyristor unit is semiconductor device which acts as a switch formed by two thyristors in antiparallel. To switch on the alternating current the input signal will be on and the thyristor will switch off at first Zero Crossing voltage with no input signal.

The benefits of thyristor units compared with electromechanical contactors are numerous: no moving parts, no maintenance and capacity to switch very fast. Thyristors are the only solution to control transformers and special loads that change resistance with temperature and with age.

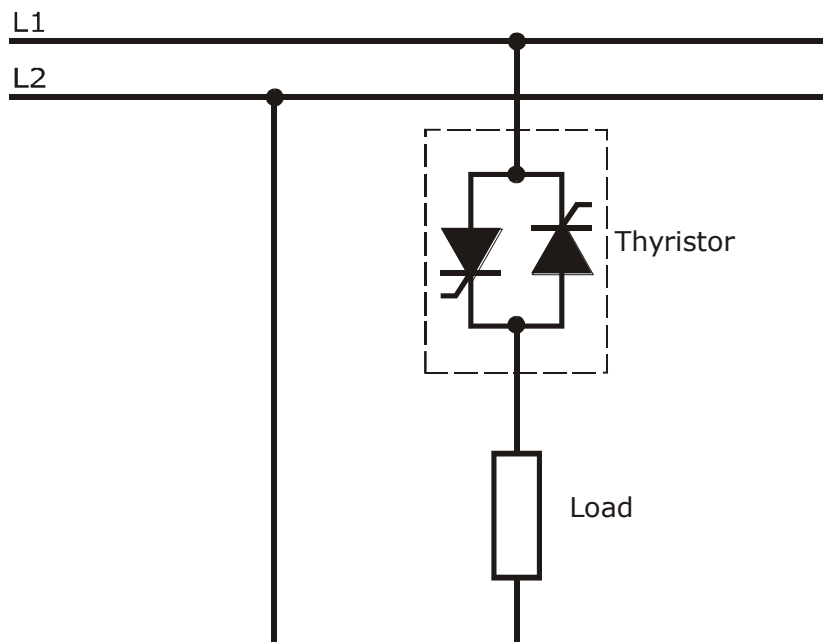

4 Advantages compared with analog thyristor unit

Communication RS485 is a standard feature of REVO M this allows the use of many information like: current, power, load state and all the parameters for diagnostic and configuration. Ulterior advantages of the digital system vs the analogical is the flexibility and the possibility of implement special characteristics without change the hardware. Several strategies can be implemented and selected through the configuration parameters.

With CDA software configuration, you can have access to the configuration parameters. To connect the Thyristor unit to the computer use the USB\TTL converter.

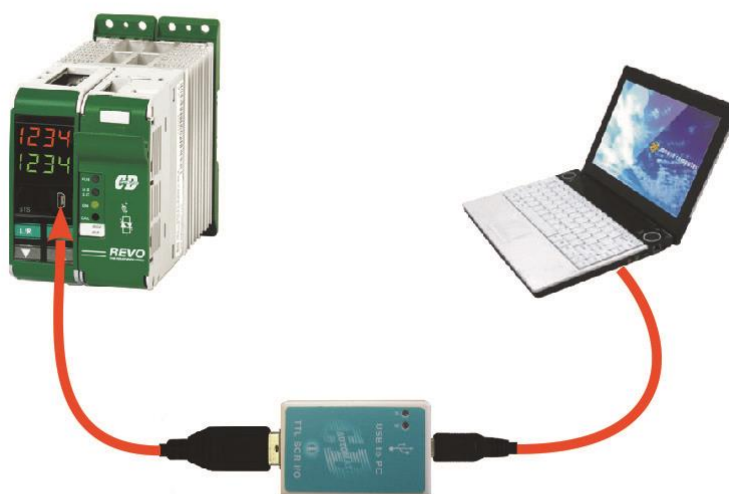

5 Software Configurator CDA Thyristor configurator software

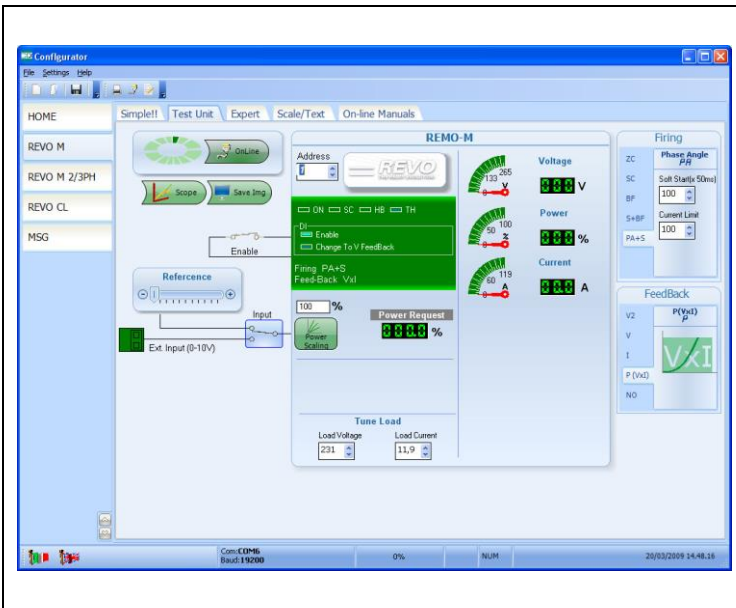

CDA Thyristor configurator software is free and is possible download it from our site: www.cdautomation.com

If the Order Code is in line with requirement, then REVO M has been already configured in Factory and it's ready to use. You need the software only to modify the ordered configuration. Anyway we suggest to check the unit on the machine with the "Test unit" section.

For install the software, launch the program and follow the instructions on the screen.

Run the software configurator and set the serial port of the PC with con baudrate =19200(default) and the address of Thyristor unit (default=1).



To connect the unit at the PC, it's necessary use the USB\TTL converter connected between the unit and the USB port of the PC.

USB\TTL converter need a driver to work properly, you can find it at www.cdautomation.com

Is available a full programmer kit composed by

- USB\TTL converter,
- Two cable
- CDA Thyristor configurator software
- USB driver on CD Rom
Utility\driver USB



With the CD-RS serial converter is possible configure the Thyristor unit also through the RS485 For this solution, the programming cable is not necessary.

6 Quick Start



Attention: *this procedure must be carried out by skilled people only.*

If your REVO M code is in line with what you really need, then the main configuration is already done by CD Automation and you just need to do the following steps:

1. Verify REVO M's current sizing. Be sure that:
 - the load current is equal or less than the nominal one of REVO M
 - the main voltage is equal or less than the nominal voltage of REVO M
2. Verify the Installation
3. Verify the Wiring:
 - all auxiliary connections must be done in line with wirings on this manual
 - verify that there isn't a short circuit on the load
4. Supply the auxiliary voltage of the unit
Set the parameters U_OP (Operative Voltage) and A_Lo (Nominal Current of the load) using the frontal keypad or CDA Thyristor configurator software.

	U_{OP}	Operative Voltage	V	R/W
Function:		It's necessary to specify the operative voltage		
Min/Max:		24 ÷ 1000V		
Default:		230		
Note:		With voltage up to 330V and over 600V, REVO M needs hardware modifications: specify this in phase of ordination.		
	A_{Lo}	Load nominal current	A	R/W
Function:		It's necessary to specify the load current value at nominal voltage. This current and voltage value are necessary to be able to read the power in engineering units		
Min/Max:		1 ÷ 100.0 Ampere (for size up to 100A)		
Default:		Nominal REVO M current value if load current has not been specified.		

If your REVO M code is NOT in line with what you really need, use the enclosed configurator software tool to set-up the unit. Install the software on your PC, select REVO M and click on test unit changing what you need.

7 Basic Connections and sizing

Star wiring with resistive load (control on two phases with REVO M-2PH)

$$I = \frac{P}{1,73V}$$

V = Nominal voltage of the load

I = Nominal current of the load

P = Nominal power of the load

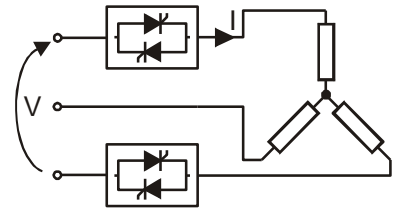

Delta wiring with resistive load (control on two phases with REVO M-2PH)

$$I = \frac{P}{1,73V}$$

V = Nominal voltage of the load

I = Nominal current of the load

P = Nominal power of the load

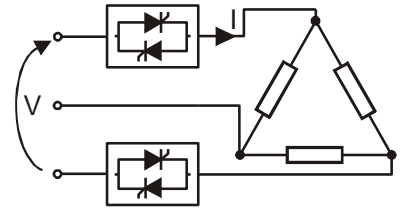

8 Identification and Order Code

8.1 Identification of the unit



Caution: Before to install, make sure that the Thyristor unit have not damages. If the product has a fault, please contact the dealer from which you purchased the product.

The identification's label give all the information regarding the factory settings of the Thyristor unit, this label is on the unit, like represented in figure.

Verify that the product is the same thing as ordered.



8.2 Order Code

Note 2

1	2	3	4	5	6	7	8	9	10	11	12	13	14	15	16
R	M	2				-									
REVO M 2PH															
4,5,6		Current													
Description code		Numeric code													
30A		0 3 0													
35A		0 3 5													
40A		0 4 0													
7		Max Voltage													
Description code		Numeric code													
480V		4													
600V		6													
8		Aux. Voltage supply													
Description code		Numeric code													
90:130V (3)		1													
170:265V (3)		2													
230:345V (3)		3													
300:530V (3)		5													
510:690V (3)		6													
9		Input													
Description code		Numeric code													
SSR		S													
0:10V dc		V													
4:20mA		A													
10KPot		K													
RS485		R													
10		Firing													
Description code		Numeric code													
Zero Crossing ZC		Z													
Burst Firing BF		B													
11		Control Mode													
Description code		Numeric code													
Open Loop		0													
Voltage Feed Back V		U													
Power Feed Back Vxl		W													
12		Fuse & Option													
Description code		Numeric code													
Fuse + Fuse Holder		Y													
Fuse + Fuse Holder +CT +HB		H													
13		Fan Voltage													
Description code		Numeric code													
No Fan		0													
14		Approvals													
Description code		Numeric code													
CE EMC For European Market		0													
cUL For American Market, Pending		L													
15		Manual													
Description code		Numeric code													
None		0													
Italian Manual		1													
English Manual		2													
German Manual		3													
French Manual		4													
16		Version													
Description code		Numeric code													
Std Version with two Fuses + Fuses Holder		1													
Third fuse on units (1)		2													

LEGEND

- CT = Current Transformer
- HB = Heater Break Alarm

Note (1): If you need one REVOIM-2PH with 3 Fuse&Fuse Holder, for dimension see REVOIM-3PH.

Note (2): After 16th digit write current and voltage of load inside brackets Ex. (40A-400V)

Note (3): Load voltage must be included in Selected Auxiliary Voltage Range

9 Technical Specifications

9.1 General features:	
Cover and Socket material:	PolymericV2
Mounting:	DIN bar (thickness type 1mm Max)
Utilization Category	AC-51 AC-55b
IP Code	20
Method of Connecting	Load in Delta, Load in Star
Auxiliary voltage, power supply Control Circuit:	90:130V (8 VA Max) 170:265V (8 VA Max) 230:345V (8 VA Max) 300:530V (8 VA Max) 510:690V (8 VA Max) 600:760V (8 VA Max)
Relay output for Heater Break Alarm (only with HB option):	0.5A a 125VAC

9.2 Input features:	
Logic input SSR:	4 ÷ 30Vdc 5mA Max (ON ≥ 4Vdc OFF < 1Vdc)
Analog Input V:	0 ÷ 10Vdc impedance 15 K ohm
Analog Input A:	4 ÷ 20mA impedance 100 ohm
POT	10 K ohm min.
Digital Input	4 ÷ 30Vdc 5mA Max (ON ≥ 4Vdc OFF < 1Vdc)

9.3 Output features(power device):	
Nominal current in continuous service:	See order code
Max peak current (10ms)	360A for unit type 030 540A for unit type 035 700A for unit type 040
Nominal Voltage range Ue :	24÷600V
Repetitive peak reverse voltage Uimp :	1200V (480V) 1600V (600V)
Latching current:	250mA
Leakage current:	15mA eff
FUSE I ² T value suggested at 500Vac tp=10msec:	525 A ² s for unit type 030 1260 A ² s for unit type 035 1260 A ² s for unit type 040
Frequency range:	47÷70Hz
Power loss (I=Inom):	76W for unit type 030 88W for unit type 035 100W for unit type 040
Isolation Voltage Ui :	2500Vac

10 Installation

Before to install, make sure that the Thyristor unit have not damages.

If the product has a fault, please contact the dealer from which you purchased the product. Verify that the product is the same thing as ordered.

The Thyristor unit must be always mounted in vertical position to improve air cooling on heat-sink.

Maintain the minimum distances in vertical and in horizontal as represented.

When more unit has mounted inside the cabinet maintain the air circulation like represented in figure.

Sometimes is necessary installing a fan to have better air circulation.

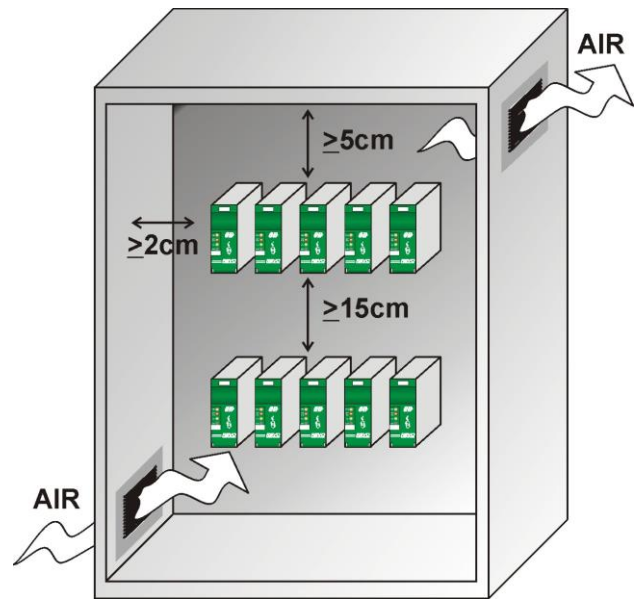

10.1 Environmental installation conditions

Ambient temperature	0-40°C at nominal current. Over 40°C use the derating curve.
Storage temperature	-25°C a 70°C
Installation place	Don't install at direct sun light, where there are conductive dust, corrosive gas, vibration or water and also in salty environmental.
Altitude	Up to 1000 meter over sea level. For higher altitude reduce the nominal current of 2% for each 100m over 1000m
Humidity	From 5 to 95% without condense and ice
Pollution Level	Up to 2nd Level ref. IEC 60947-1 6.1.3.2

10.2 Derating Curve

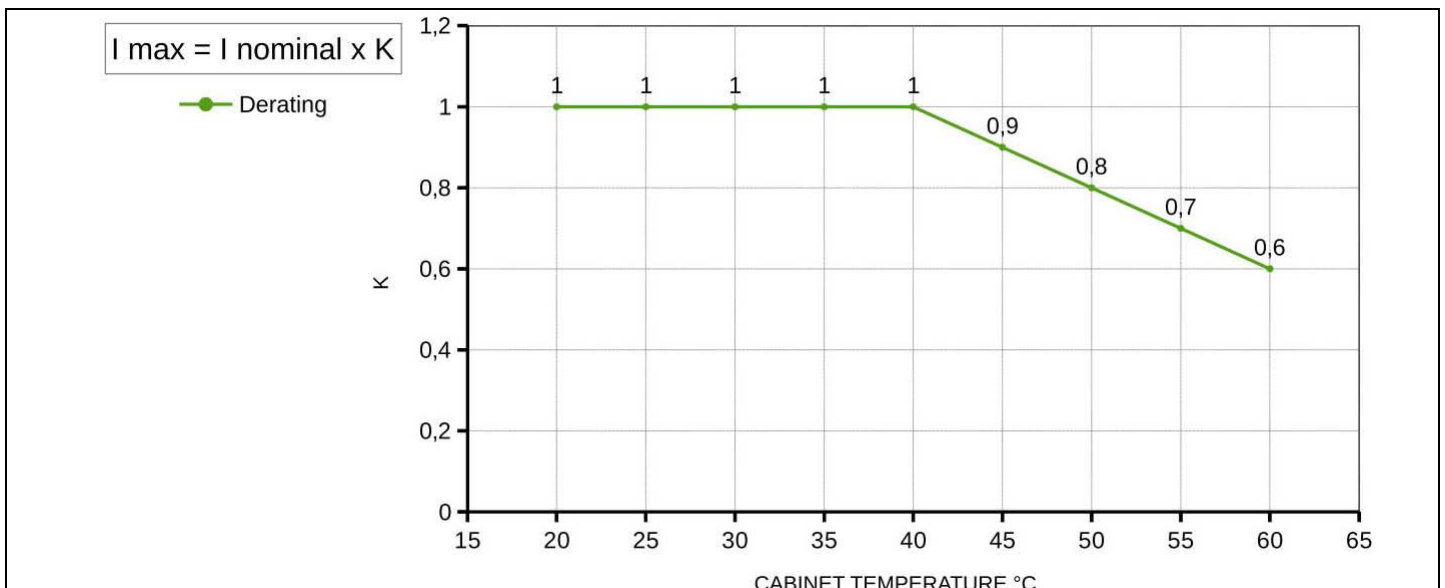

10.3 Dimensions and Weight

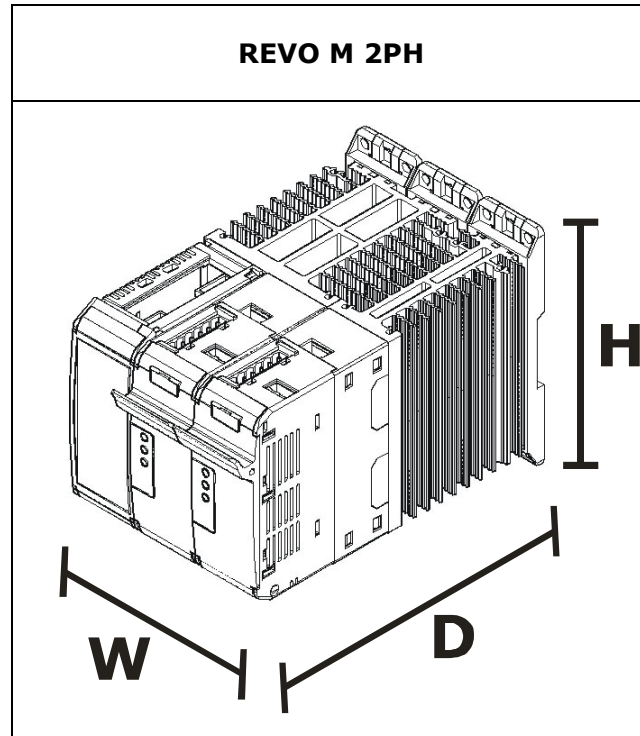

Size	W(mm)	H(mm)	D(mm)	Weight (kg)
2PH	108	121	185	1,76

10.4 Fixing holes

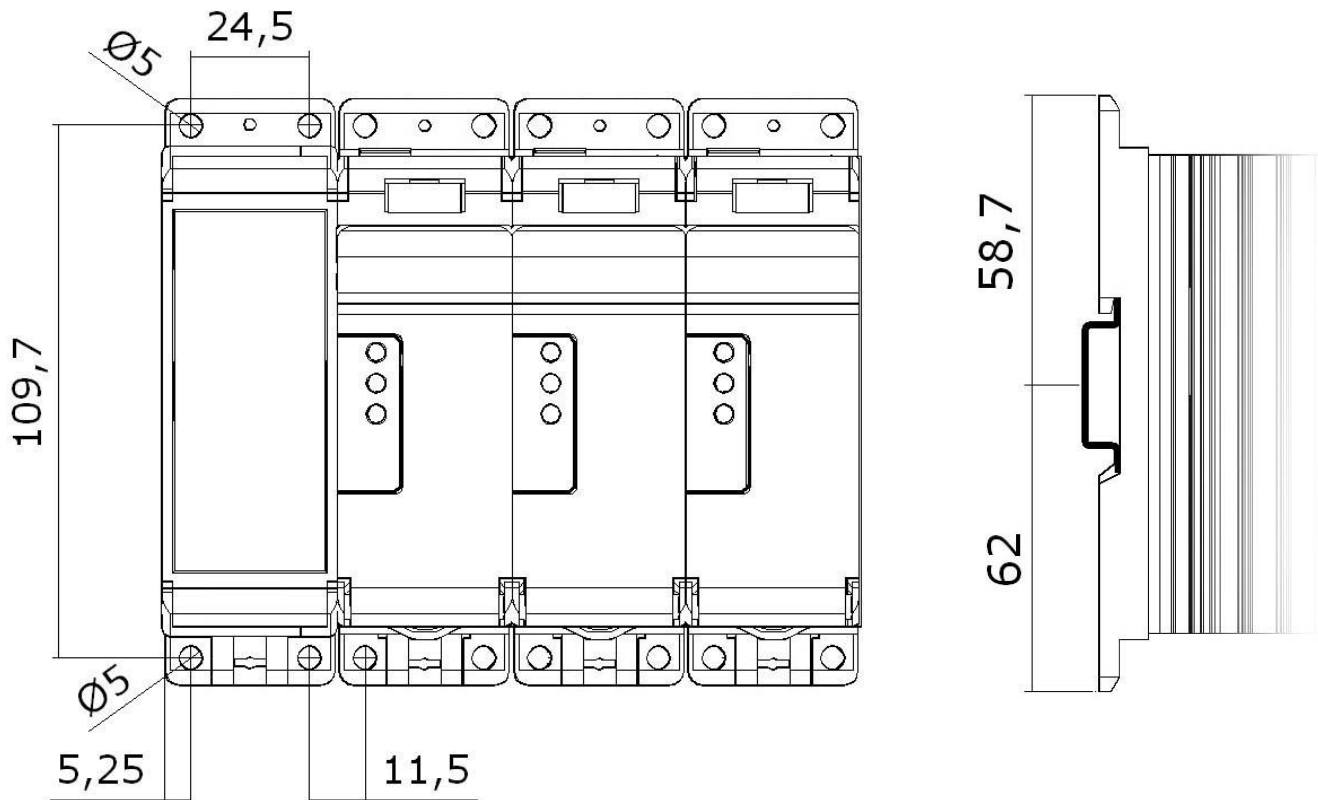

11 Wiring instructions

The Thyristor unit could be susceptible to interferences lost by near equipments or by the power supply, for this reason in accord to the fundamental practices rules is opportune take some precautions:

- The coil contactor, the relays and other inductive loads must be equipped with opportune RC filter.
- Use shielded bipolar cables for all the input and output signals.
- The signal cables must not be near and parallel to the power cables.
- Local regulations regarding electrical installation should be rigidly observed.

Use copper cables and wires rated for use at 75°C only.

Power cable torque (suggested)

Type	Connector Type	Torque Lb-in (N-m)	Wire Range mm ² (AWG)	MAX Current Terminals	Wire Terminals UL Listed (ZMVV)
030 035 040	Screw M5	26.6 (3.0)	1.5-10 (16-8)	40A	Rigid / Flexible Spade Terminal

Cable dimensions of the Command Terminals

0.5mm² (AWG 18)

Cable dimensions of the Earth (suggested)

6 mm² (AWG 10)



Warning: Before connecting or disconnecting the unit check that power and control cables are isolated from voltage sources.

Terminal	Description
L1	Line Input Phase 1
T1	Load Output Phase 1
L3	Line Input Phase 2
T3	Load Output Phase 2

11.1 Access to L1-L3 and T1-T3 terminal Screw

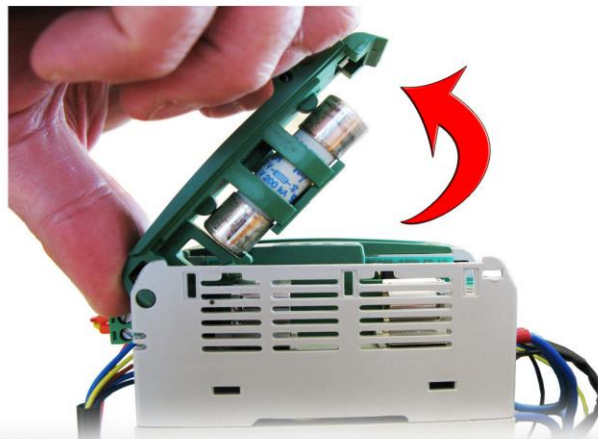
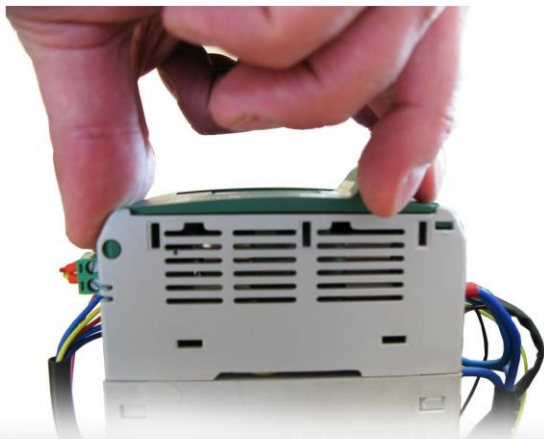

1. Open fuse holder by pulling the frontal cover

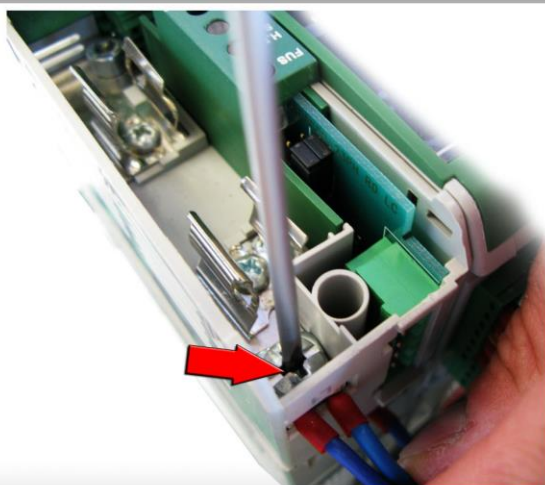

2. Fix the wire on Ln

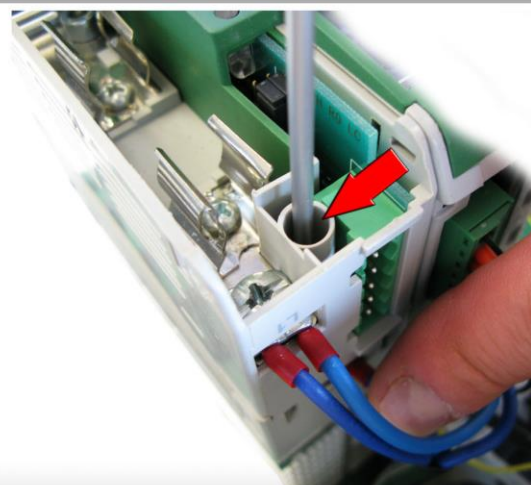

3. Fix the wire on Tn

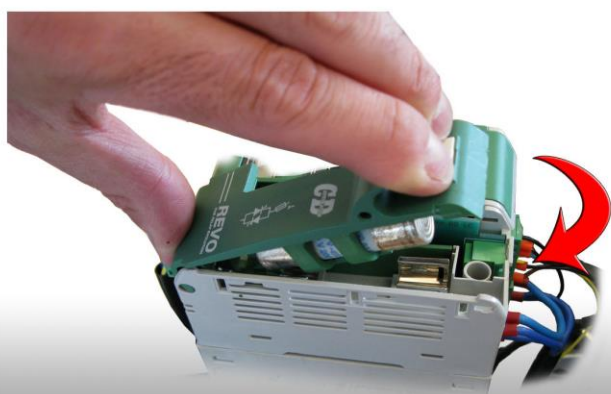

4. Close the cover by pressing.

Repeat for each phase.

11.2 Command Terminals



Warning: Before connecting or disconnecting the unit check that power and control cables are isolated from voltage sources.

11.2.1 Terminal block M2

Terminal	Description
1	GND
2	COM I - Common Digital Input
3	DI 2 - Enable Digital Input
4	DI 1 - Configurable Input
5	+ Control Input (SSR/0-10Vdc/4-20mA)
6	- Control Input (SSR/0-10Vdc/4-20mA)
7	+10V Output
8	Slave Output - (factory connection)
9	Slave Output + (factory connection)

11.2.2 Terminal block M1

Terminal	Description
10	GND
11	TA1 Input (factory connection)
12	TA1 or TA2 input (factory connection)
13	TA3 input (factory connection)
14	C - Common contact alarm relay output
15	NO - Normally Open contact alarm relay output (HB)
16	NC - Normally Close contact alarm relay output (HB)

11.2.3 Terminal block M3

Terminal	Description
A+	RS485 A
B-	RS485 B

11.2.4 Terminal block M4

Terminal	Description
L1	Aux - Voltage Supply for electronic boards and synchronization (See order code for the Value)
-	Not Connected
L2/N	Aux - Voltage Supply for electronic boards and synchronization (See order code for the Value)

11.3 Schematic

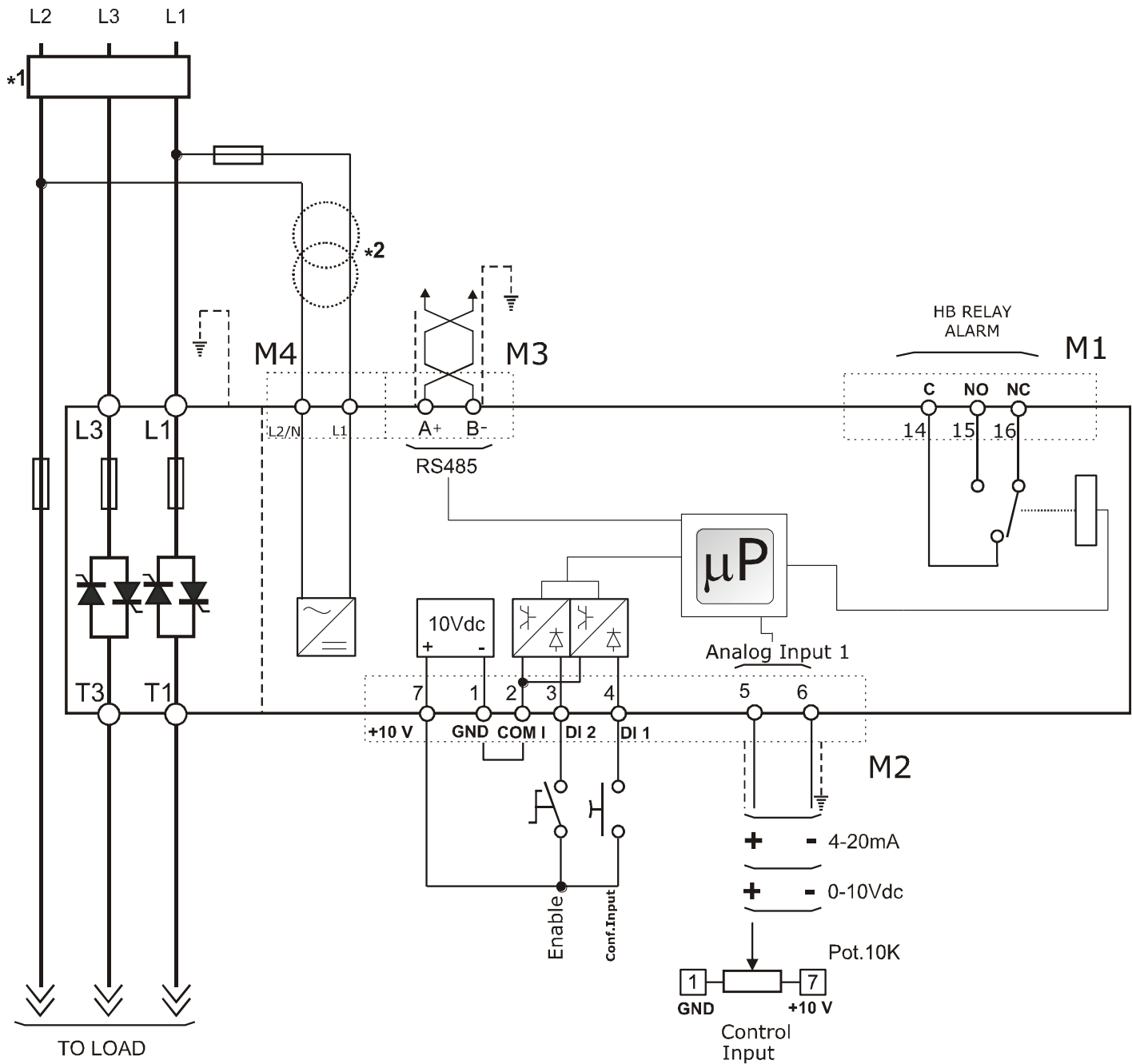

NOTE:

- *1 The user installation must be protecting by electromagnetic circuit breaker or by fuse isolator. The Fuse I2t should be 20% less than I2t of power controller. Semiconductor fuses are classified for UL as supplementar protection for semiconductor. They are note approved for branch circuit protection.
- *2 The auxiliary voltage supply of the Revo M unit must be synchronized with load voltage power supply. If the Auxiliary Voltage (written on the identification label) is different from Supply Voltage (to the load), use an external transformer as designated.

TOP VIEW

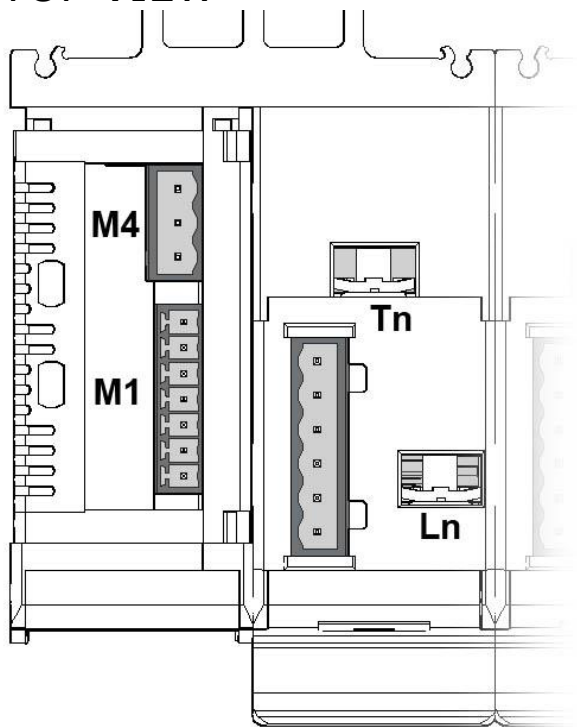

DOWN VIEW

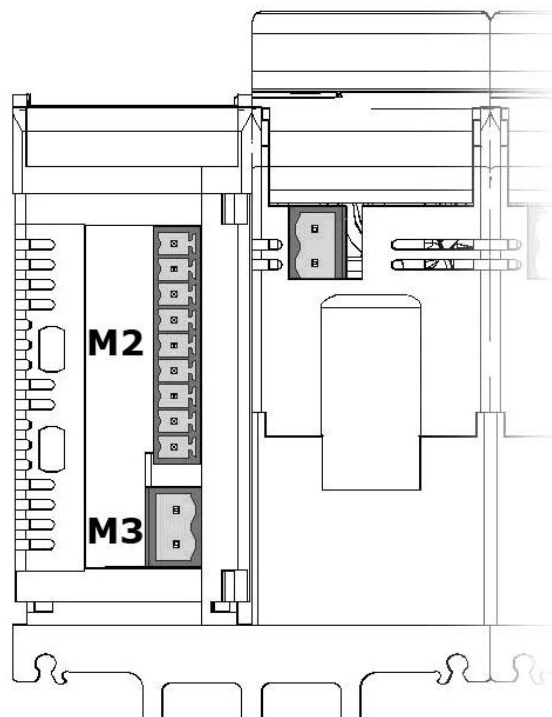

11.4 Connection Diagram for 3 phases (control on 2 phases)



Caution: this procedure must be performed only by qualified persons.

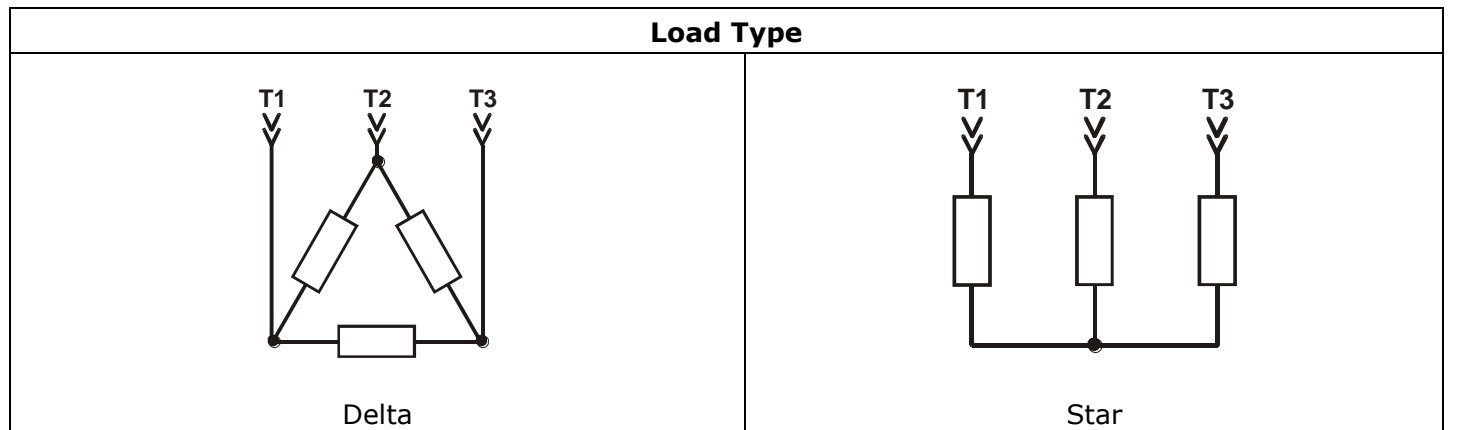
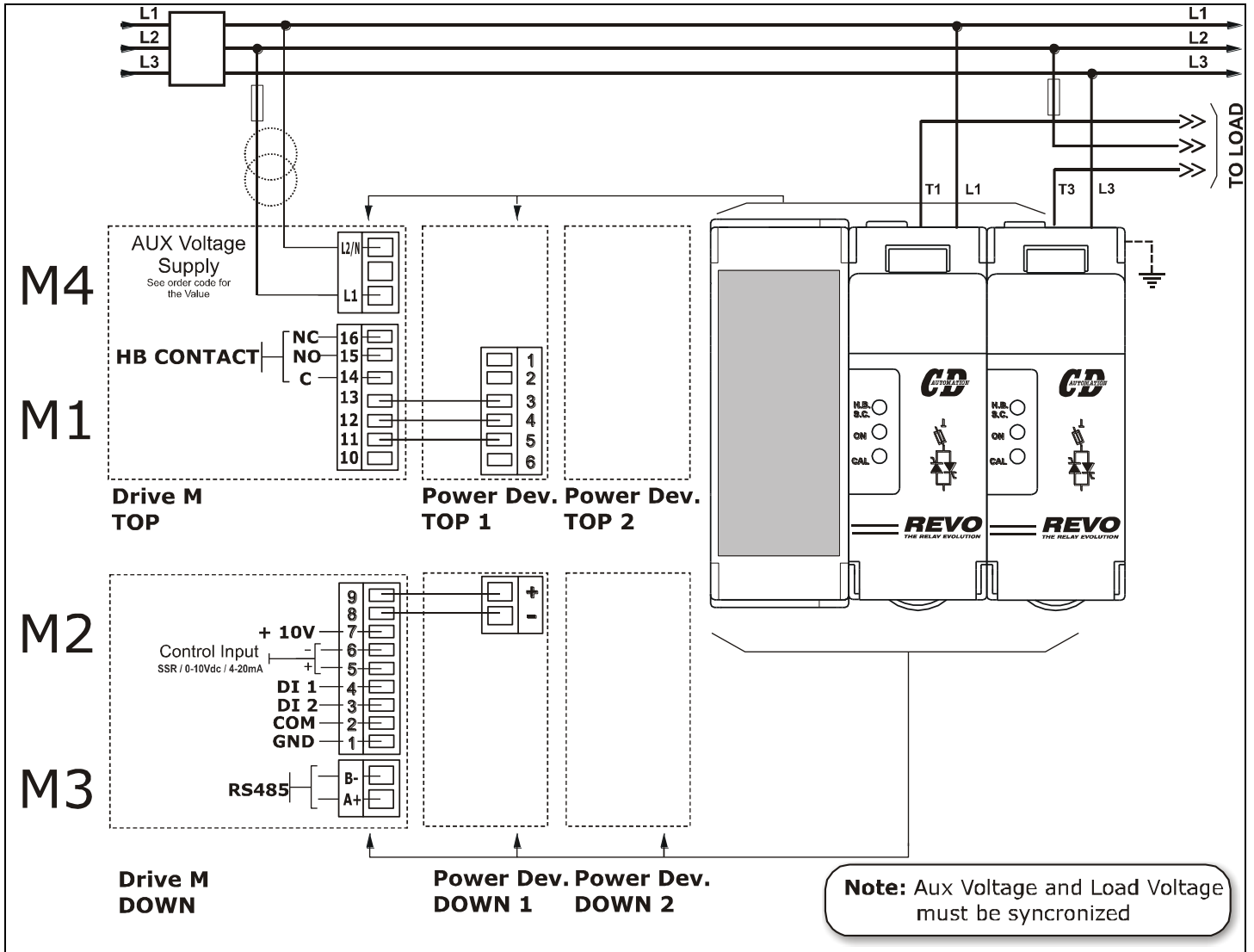

12 Control Panel

The Control Panel is placed on the front of the thyristor unit, on his display you can visualize the alarms, the input and output signals and all the configuration parameters.

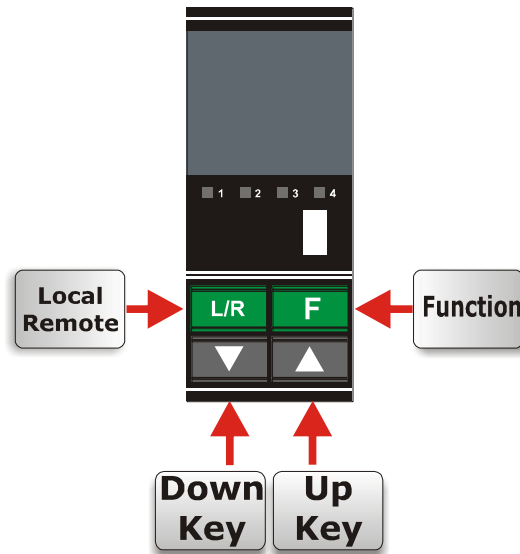

The function keys are the following:

- The **Function key F** is used to scroll the parameter *A U P*.
- The **UP key and DOWN key** are used to set the parameters in the menu and to change data.
- The **L/R key** is used to edit the parameters and to save the modified values.
- The **F+L/R** is used for enter and exit from the menu.

The Control Panel have three menu, and to enter in one of them you must set correctly the parameter *PASS* :

- Operator Menu (*PASS* = 2)
This menù contains a reading parameters that give information on the state of the unit, it include also the base parameters for quick start, like the value of current and voltage load and the Set-point data.
- Hardware Menu (*PASS* = 5)
This menu contains all the configuration parameters for analogic and digital I/O, and the parameters to set the serial port like the address and the baudrate.
- Setup Menu (*PASS* = 10)
This menù contains all the setting parameters to configure the thyristor unit, like the firing type, the current limit, [ecc].

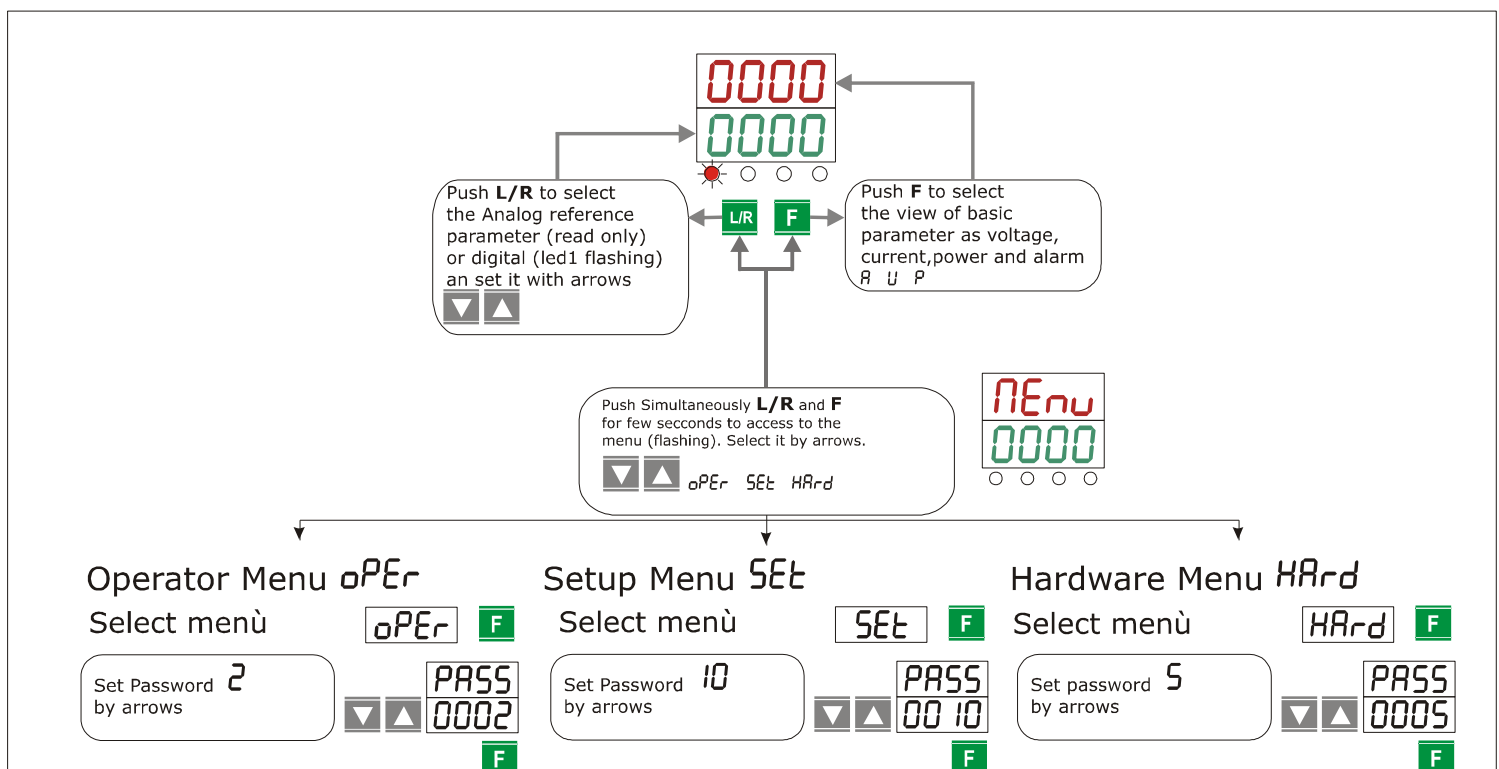

12.1 Scroll the parameters

Operator Menu *oPEr*

F ▼ ▲ Set Max Output F outn

F Read Power Output F P

F Read Current Output F R

F Read average voltage Output F Uout

F ▼ ▲ Set Load Voltage F U_oP

F ▼ ▲ Set Load Current F R_lo

F Digital input 1 Value F d i 1

F Digital input 2 Value F d i 2

F Analogic\Dig. Value F A_d

F ▼ ▲ Unit Enable Value F EnAb

F ▼ ▲ Digital Set Point F L/R SP

To exit from the menu push a long time both L/R F

Setup Menu *SEt*

F ▼ ▲ Set Firing type F F ir

F ▼ ▲ Set HB Sensitivity F Hb_S

F ▼ ▲ Set HB Delay F Hb_d

F ▼ ▲ Set FeedBack type F FEEd

F ▼ ▲ Set cycle time. Only $F_{ir}=C_r$ F ct n

F ▼ ▲ Set cycle Burst Firing. only $F_{ir}=bF-bFr-bFd$ F bf_n

F ▼ ▲ Set Load Type F LoAd

F ▼ ▲ Set Proportional Band F Pb

F ▼ ▲ Set Integral Time F t i

F ▼ ▲ Start up displayed parameter F StPr

F ▼ ▲ Option not used F rtPr

To exit from the menu push a long time both L/R F

Hardware Menu *HArd*

F ▼ ▲ Set analog input type F A_In

F ▼ ▲ Set Min. Value Input 1. F L i A 1

F ▼ ▲ Set Max. Value Input 1 F H i A 1

F ▼ ▲ Set Digital Input 1 F C d i 1

F ▼ ▲ Set Digital Input 2 F C d i 2

F ▼ ▲ Set Digital Output 1 F C d o 1

F ▼ ▲ Serial Port Baud Rate F bAud

F ▼ ▲ Serial Port Address F Addr

To exit from the menu push a long time both L/R F

12.2 Operator Menu *oPEr*

- Push simultaneously **L/R** and **F** for few seconds to **access** to the menu (*Menu* flashing).
- Select by arrows **UP** and **DOWN** : *oPEr* then press **F**.
- Select by arrows **UP** and **DOWN** : *2* as password then press **F**.
- You have access to the parameter on *oPEr* menu.
- Select by arrows **UP** and **DOWN** the required parameter.
- If the parameter is **Write/Read (W/R)** press **F** (parameter flashing) then select by arrows **UP** and **DOWN** the required value, press **F** to set the new value.
- Push simultaneously **L/R** and **F** for few seconds to **Exit** from the menu

- **Maximum output:** Its' a scaling factor of the Input command signal.

Parameter Display	Parameter Name	Contents	UM	Default Value UM	Min Value DEC	Max Value DEC	Min Value UM	Max Value UM	Par. Type
<i>outN</i>	OutN	Maximum output	%	100	0	255	0	100	R/W

Sample Values and Note

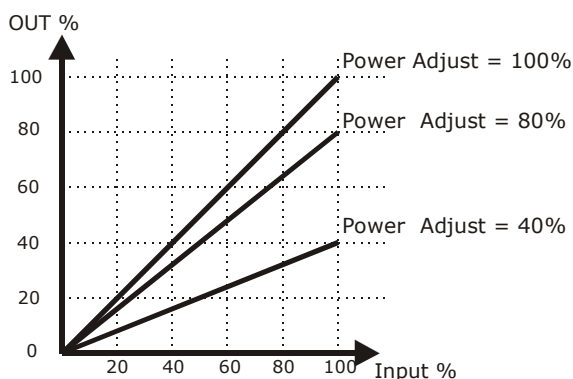

- **Power output:** This parameter shows the Average power output.

Parameter Display	Parameter Name	Contents	UM	Default Value UM	Min Value DEC	Max Value DEC	Min Value UM	Max Value UM	Par. Type
<i>P</i>	P	Power output	%	-	0	1023	0	100	R

- **Current output:** This parameter shows the Average Current output.

Parameter Display	Parameter Name	Contents	UM	Default Value UM	Min Value DEC	Max Value DEC	Min Value UM	Max Value UM	Par. Type
<i>A</i>	A	Current output	A	-	0	1023	0	102,3	R

- **Average voltage output:** This parameter show the Average voltage output.

Parameter Display	Parameter Name	Contents	UM	Default Value UM	Min Value DEC	Max Value DEC	Min Value UM	Max Value UM	Par. Type
<i>Uout</i>	Vout	Average voltage	V	-	0	1023	0	1023	R/W

- **Operative Load Voltage:** This parameter is used to set in volt the operative voltage of the load.

Parameter Display	Parameter Name	Contents	UM	Default Value UM	Min Value DEC	Max Value DEC	Min Value UM	Max Value UM	Par. Type
<i>U_oP</i>	V_oP	Operative Load Voltage	V	229	0	1023	0	1023	R/W

- **Load nominal Current:** This parameter is used to set the Load nominal Current. This parameter is necessary to have the correct rescaling inside the unit. For this reason it's very important specify this value in the order code.

Parameter Display	Parameter Name	Contents	UM	Default Value UM	Min Value DEC	Max Value DEC	Min Value UM	Max Value UM	Par. Type
<i>A_Lo</i>	A_Lo	Load nominal Current	A	UnitType Max Current	0	1023	0	102,3	R/W

▪ Digital Input 1:

Parameter Display	Parameter Name	Contents	UM	Default Value UM	Min Value DEC	Max Value DEC	Min Value UM	Max Value UM	Par. Type
<i>d_i1</i>	Di1	Digital input 1	SW	-	0	1	0	1	R

Sample Values and Note

Di1 = *off*

Di1 = *on*

▪ Digital Input 2:

Parameter Display	Parameter Name	Contents	UM	Default Value UM	Min Value DEC	Max Value DEC	Min Value UM	Max Value UM	Par. Type
<i>d_i2</i>	Di2	Digital input 1	SW	-	0	1	0	1	R

Sample Values and Note

Di2 = *off*

Di2 = *on*

- **Analog/Digital Selection:** to set the main reference parameter taken from Analogic or Digital Input

Parameter Display	Parameter Name	Contents	UM	Default Value UM	Min Value DEC	Max Value DEC	Min Value UM	Max Value UM	Par. Type
<i>A_d</i>	A_d	Analog/Digital Selection	SW	Digital	0	1	0	1	R/W

Sample Values and Note

A_d = *d 19* Digital

A_d = *AnJ* Analog.

▪ **Unit Enable Selection:**

Parameter Display	Parameter Name	Contents	UM	Default Value UM	Min Value DEC	Max Value DEC	Min Value UM	Max Value UM	Par. Type
EnAb	EnAb	Unit Enable Selection	SW	Off	0	1	0	1	R/W

Sample Values and Note

EnAb = *off*

EnAb = *on*

▪ **Digital Set Point:**

Parameter Display	Parameter Name	Contents	UM	Default Value UM	Min Value DEC	Max Value DEC	Min Value UM	Max Value UM	Par. Type
SP	SP	Digital SetPoint	%	100.0	0	1023	0	100	R/W

Sample Values and Note

Input 4mA P015 SP = 0%

Input 12mA P015 SP = 50%

Input 20mA P015 SP = 100%

12.3 Setup Menu *SEt*

- Push simultaneously **L/R** and **F** for few seconds to **access** to the menu (*Menu* flashing).
- Select by arrows **UP** and **DOWN** : *SEt* then press **F**.
- Select by arrows **UP** and **DOWN** : *10* as password then press **F**.
- You have access to the parameter on *SEt* menu.
- Select by arrows **UP** and **DOWN** the required parameter.
- If the parameter is **Write/Read (W/R)** press **F** (parameter flashing) then select by arrows **UP** and **DOWN** the required value, press **F** to set the new value.
- Push simultaneously **L/R** and **F** for few seconds to **Exit** from the menu

▪ Set Firing type:

Parameter Display	Parameter Name	Contents	UM	Default Value UM	Min Value DEC	Max Value DEC	Min Value UM	Max Value UM	Write Read
<i>Fir</i>	Fir	Firing mode Selection	SW	2*	0	1024	0	1024	R/W

*Default Value if not specified in the Order Code

Sample Values and Note

- 1 = Zero Crossing *Cr*
- 2 = Burst Firing *bF*

▪ Set HB sensitivity:

This parameter defines the threshold of resistance that activates the HB alarm
This value is in percentage respect the nominal resistance load value

Parameter Display	Parameter Name	Contents	UM	Default Value UM	Min Value DEC	Max Value DEC	Min Value UM	Max Value UM	Par. Type
<i>Hb_S</i>	Hb_S	HB sensitivity	%	100	0	100	0	100	R/W

▪ Set HB Delay: This parameter set a delay to have HB alarm active

Parameter Display	Parameter Name	Contents	UM	Default Value UM	Min Value DEC	Max Value DEC	Min Value UM	Max Value UM	Par. Type
<i>Hb_d</i>	Hb_S	HB delay	sec	20	0	255	0	255	R/W

▪ Set FeedBack type: This parameter selects the Feed-back type.

Parameter Display	Parameter Name	Contents	UM	Default Value UM	Min Value DEC	Max Value DEC	Min Value UM	Max Value UM	Par. Type
<i>FEEd</i>	FEEd	Feed back selection	SW	1*	0	1024	0	1024	R/W

*Default Value if not specified in the Order Code

Sample Values and Note

- 0 = V2 *U2*
- 1 = NO Feed Back *nooE*
- 32 = Voltage V *U*
- 64 = Current I *I*
- 128 = Power V X I *P*

▪ Cycle Time:

The Cycle Time is the time which the Thyristor modulates to obtain the power demand.

Parameter Display	Parameter Name	Contents	UM	Default Value UM	Min Value DEC	Max Value DEC	Min Value UM	Max Value UM	Par. Type
ct n	ctiN	Cycle time	mSec x50	60	0	255	0	255	R/W

Sample Values and Note

Only with Fir = Zero Crossing ζ

With a Cycle time at 4 sec:

25% -> 1sec On+3sec off

50% -> 2sec On+2sec off

75% -> 3sec On+1sec off

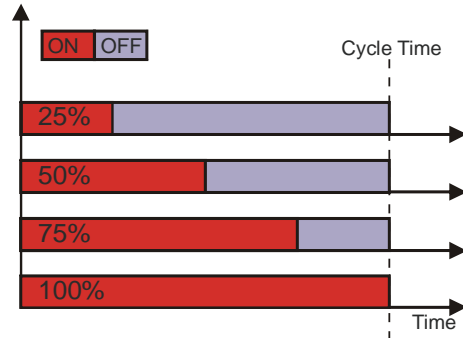

▪ Burst Firing Cycles number:

It defines the number of voltage cycles in ON condition at 50% of power demand

Parameter Display	Parameter Name	Contents	UM	Default Value UM	Min Value DEC	Max Value DEC	Min Value UM	Max Value UM	Par. Type
bF_n	bF_n	Burst Firing Cycles	Cycle	4*	1	255	1	255	R/W

Sample Values and Note

Only with Fir = Burst Firing

bF

*Default Value if not specified in the Order Code

▪ Load Type:

Parameter Display	Parameter Name	Contents	UM	Default Value UM	Min Value DEC	Max Value DEC	Min Value UM	Max Value UM	Par. Type
LoAd	Load	Load Type	SW	0	0	3	0	3	R/W

Sample Values and Note

0 = STAR

2 = DELTA

- **Set Proportional Band:** This parameter is the gain of the feed-back loop.

Parameter Display	Parameter Name	Contents	UM	Default Value UM	Min Value DEC	Max Value DEC	Min Value UM	Max Value UM	Par. Type
Pb	Pb	Proportional Band	%	8	1	255	1	255	R/W

- **Set Integral Time:** This parameter is the integral time of the feed-back loop.

Parameter Display	Parameter Name	Contents	UM	Default Value UM	Min Value DEC	Max Value DEC	Min Value UM	Max Value UM	Par. Type
ti	ti	Set Integral time	%	20	1	255	1	255	R/W

- **Start Up Displayed Parameter:** This parameter select the default output value displayed at the start up of the unit.

Parameter Display	Parameter Name	Contents	UM	Default Value UM	Min Value DEC	Max Value DEC	Min Value UM	Max Value UM	Par. Type
StPr	StPr	Start Up Parameter	SW	U	0	1024	0	1024	R/W

Sample Values and Note

81 = Voltage output

U

82 = Current output

I

128 = Power V X I

P

12.4 Hardware Menu *HArd*

- Push simultaneously **L/R** and **F** for few seconds to **access** to the menu (*Menu* flashing).
- Select by arrows **UP** and **DOWN** : *HArd* then press **F**.
- Select by arrows **UP** and **DOWN** : *5* as password then press **F**.
- You have access to the parameter on *HArd* menu.
- Select by arrows **UP** and **DOWN** the required parameter.
- If the parameter is **Write/Read (W/R)** press **F** (parameter flashing) then select by arrows **UP** and **DOWN** the required value, press **F** to set the new value.
- Push simultaneously **L/R** and **F** for few seconds to **Exit** from the menu

▪ Set Analog input Value:

Parameter Display	Parameter Name	Contents	UM	Default Value UM	Min Value DEC	Max Value DEC	Min Value UM	Max Value UM	Par. Type
<i>A_in</i>	A_1n	Input type	V	3*	0	255	0	255	R/W

Sample Values and Note

0 = SSR Input	<i>55r</i>
1 = 0-10 Vdc / 10Kpot	<i>0_10</i>
2 = 4-20 mA	<i>4_20</i>
3 = 0-20 mA	<i>0_20</i>

▪ Set Minimum input1 value:

Parameter Display	Parameter Name	Contents	UM	Default Value UM	Min Value DEC	Max Value DEC	Min Value UM	Max Value UM	Par. Type
<i>L A1</i>	L A1	Save value Minimum input 1	Sw	0	0	1	0	1	R/W

Sample Values and Note

Default Value	<i>DEF</i>
Save Value	<i>SAUE</i>

Only with *A_in* Analog Input Value = *0_10 4_20 0_20*

▪ Set Maximum input1 value:

Parameter Display	Parameter Name	Contents	UM	Default Value UM	Min Value DEC	Max Value DEC	Min Value UM	Max Value UM	Par. Type
<i>H A1</i>	HiA1	Save value Maximum input 1	Sw	0	0	1	0	1	R/W

Sample Values and Note

Default Value	<i>DEF</i>
Save Value	<i>SAUE</i>

Only with *A_in* Analog Input Value = *0_10 4_20 0_20*

- **Digital input 1 configuration :** This parameter selects the function of digital input.

Parameter Display	Parameter Name	Contents	UM	Default Value UM	Min Value DEC	Max Value DEC	Min Value UM	Max Value UM	Par. Type
[d i 1]	CDi1	Digital input 1 configuration	SW	0	0	3	0	3	R/W

Sample Values and Note

0 = Enable	<i>EnAb</i>
2 = Change To V FeedBack	<i>Fbtr</i>
3 = L/R Enable	<i>LrE</i>
4 = Change Firing PA/xx	<i>FirE</i>

- **Digital input 2 configuration :** This parameter selects the function of digital input.

Parameter Display	Parameter Name	Contents	UM	Default Value UM	Min Value DEC	Max Value DEC	Min Value UM	Max Value UM	Par. Type
[d i 2]	CDi2	Digital input 2 configuration	SW	0	0	3	0	3	R/W

Sample Values and Note

0 = Enable	<i>EnAb</i>
2 = Change To V FeedBack	<i>Fbtr</i>
3 = L/R Enable	<i>LrE</i>
4 = Change Firing PA/xx	<i>FirE</i>

- **Digital Output 1 configuration :**

Parameter Display	Parameter Name	Contents	UM	Default Value UM	Min Value DEC	Max Value DEC	Min Value UM	Max Value UM	Par. Type
[d o 1]	CDo1	DigitalOut. 1 configuration	SW	0	0	3	0	3	R/W

Sample Values and Note

0 = Enable HB - SCR s.c Alarms	<i>ALEn</i>
1 = Disable HB Alarm	<i>SCEn</i>
2 = Disable SCR Alarm	<i>HbEn</i>
3 = Disable HB - SCR s.c Alarms	<i>None</i>

- **Serial port Baud Rate :** This parameter selects the Baud rate on the serial port.

Parameter Display	Parameter Name	Contents	UM	Default Value UM	Min Value DEC	Max Value DEC	Min Value UM	Max Value UM	Par. Type
bAud	bAud	Baud Rate	SW	2	0	3	0	3	R/W

Sample Values and Note

0 = 4800 baud	<i>4800</i>
1 = 9600 baud	<i>9600</i>
2 = 19200 baud	<i>1920</i>
3 = 38400 baud	<i>3840</i>

▪ **Serial port Address :**

This parameter selects the Address on the serial port for the thyristor unit.

Parameter Display	Parameter Name	Contents	UM	Default Value UM	Min Value DEC	Max Value DEC	Min Value UM	Max Value UM	Par. Type
<i>Addr</i>	Addr	Address	Add.	1	1	255	1	255	R/W

12.5 Control Panel Led

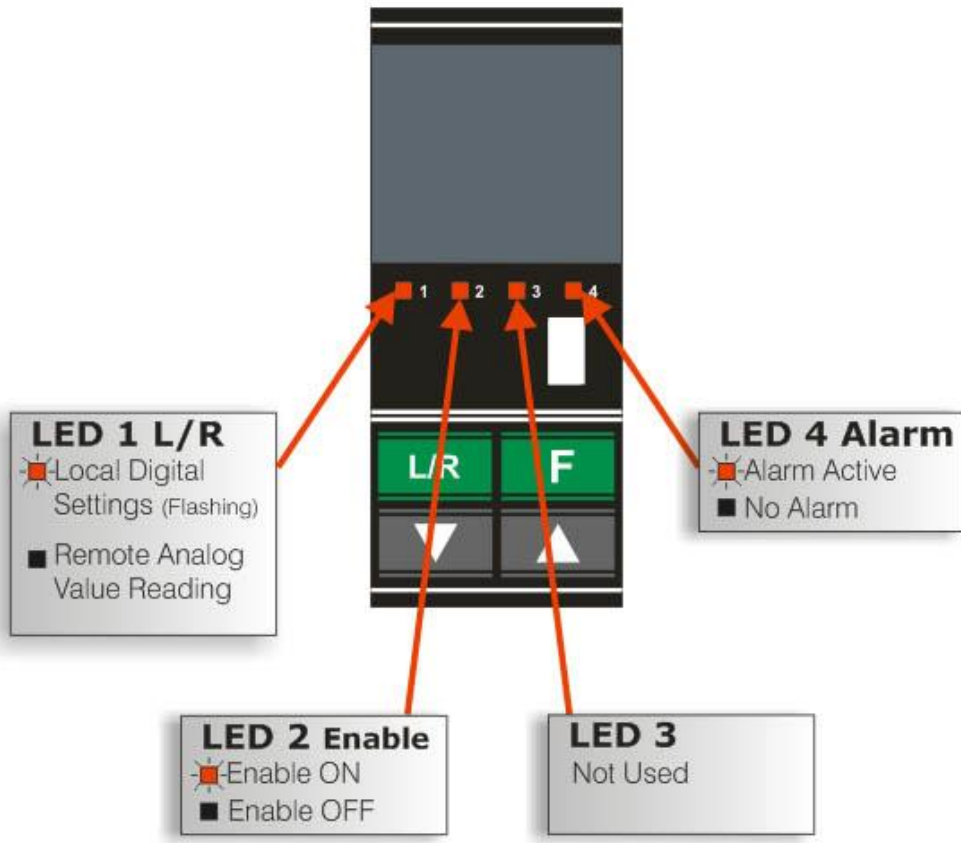

12.6 Displayed Alarms

Alarm on Display	Description
<i>SHrt</i>	Short Circuit on SCR!
<i>ALHb</i>	Heater Break Alarm!

13 Input output signal

13.1 Digital Input

The REVO M thyristor unit has 2 digital inputs opto-isolated to 24Vdc 5 mA.

You can activate the inputs with the internal supply or with an external source for example the PLC.

13.1.1 Start/Stop (Terminal 3 of M2)

This is the start command (Enable) of the REVO M.

If you Remove the Start command the REVO M thyristor unit will be stopped and the output will return at zero.

13.1.2 Configurable Input (Terminal 4 of M2)

This digital input is configured by the parameter CDI and could perform different functions:

- Enable:
This function forces the output at zero.
- Feed-Back Selection:
With this function, when you active the input, the feed-back setted in the parameter $FEEB$ change in Voltage Feed-Back (V).
- Analog/Digital Setpoint(Local/Remote):
With this function, when you active the input, the setpoint reference change from Analog input to Digital value in bumpless mode, setted in the parameter SP . The parameter SP is not stored in memory.

13.2 Digital Output terminal (terminal 14-15-16 of M1)

The REVO M thyristor unit has 1 relay output on terminal 14-15-16 of terminal block M1

(Max 500mA, 125Vac). The functionality of this output can be setted with the parameter COI

This digital output can be configured in order to activate itself after that one of these alarms occurs:

- HB and SC alarm are active.
- Only HB alarm is active.
- Only SC alarm is active.

13.3 Analog Input

Primary Input (Terminals 5 and 6 of M2)

The REVO M thyristor unit has 1 analog inputs (0÷10V, 0÷20mA, 4÷20mA ecc) for the analog setpoint.

The primary input is already configured in line with customer requirements that are defined in the Order Code. The Order Code is written on the identification label.

However, if you wish to change the primary input (ex. from 0÷10V to 0÷20mA, 4÷20mA).

see par. Analog Inputs 17.3. for details

14 Heater Break alarm and SCR short circuit (HB Option)



Caution: to work properly the load must be powered at least about 160msec.

The Heater Break circuit read the load resistance with an Internal voltage transducer and Internal current transformer (C.T.), to calculate the resistance (V/I).

Minimum current is 10% of the current transformer size.

If load current is below this value the Heater Break Alarm doesn't work properly.

14.1 Heater break Calibration procedure

An automatic function sets the Heater Break Alarm ,when write in the parameter **A_{Lo}** the load current and in the parameter **U_{oP}** the load voltage.

If the load resistance increases due to a partial or total load failure ,the HB alarm become ON and alarm relay change status.

You can Adjust the sensibility of HB alarm by using the parameter **Hb_S** This parameter is set between 1 and 255% of the nominal resistance.

This parameter is the maximum increment of the resistance Load to establish the HB Alarm.

There is also **Hb_d** parameter to set a delay to have HB alarm active.

14.2 HB alarm contact (digital output)

The Revo unit with HB option, is supplied with Heater Break alarm contact normally opened (NO):

- In normal conditions (without alarm) and with auxiliary power supply, the contact to the terminals has opened (relay coil energized).
- In alarm condition or without auxiliary power supply the contact to the terminals is closed (relay coil not energized).

This alarm can be configured in order to activate itself after that one of these alarms occurs:

- HB and SC alarm are active.
- Only HB alarm is active.
- Only SC alarm is active.

15 Firing type

Choose an correct firing type allows to optimize the thyristor unit for the installed load. The firing type has already configured in line with customer requirements that are defined in the Order Code. The Order Code is written on the identification label. However, if you wish to change the firing type you can use the software configurator or the Control Panel F_{ir} parameter on SEt menu.



Caution: this procedure must be performed only by qualified persons.

15.1 Zero Crossing (ZC - ZC)

ZC firing mode is used with Logic Output from temperature controllers and the Thyristor operates like a contactor. The Cycle time is performed by temperature controller. ZC minimizes interferences because the Thyristor unit switches ON-OFF at zero voltage.

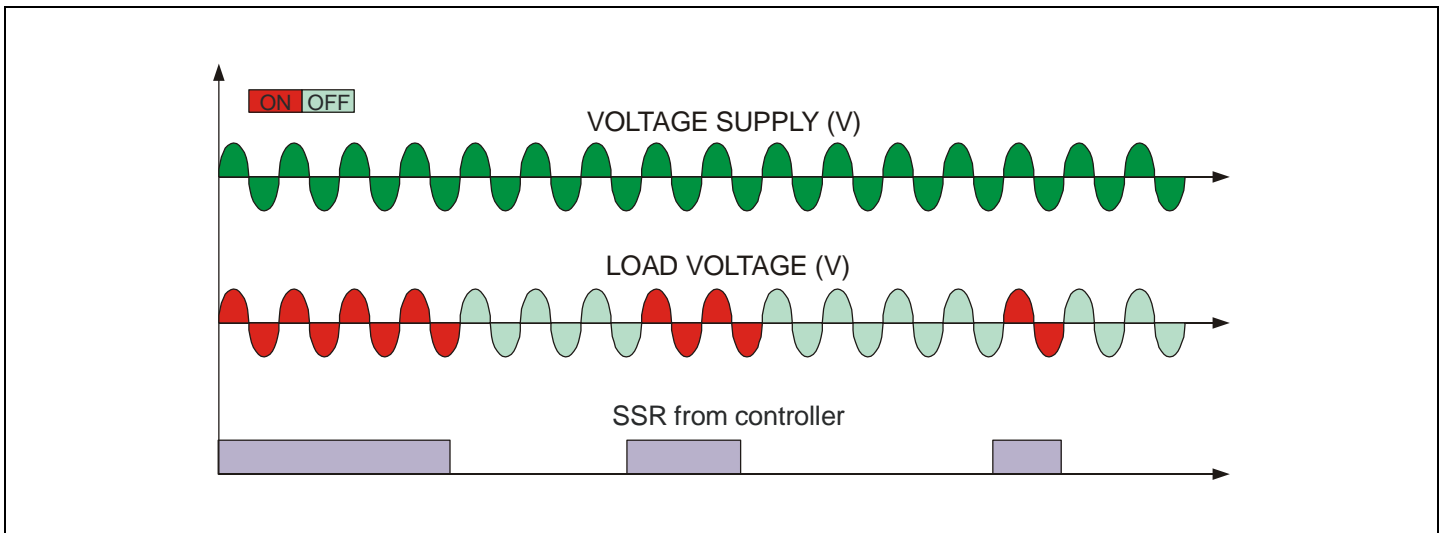

15.2 Burst Firing (BF - BF)

The Burst Firing is similar to the Single Cycle, but consecutive cycles ON are selectable between 2 and 255, with input signal equal at 50%.

Burst Firing is a method zero crossing that it reduces the electromagnetic interferences because the thyristor switches at zero voltage crossing.

The example show the Burst Firing with Burst cycles: $BF_n = 4$

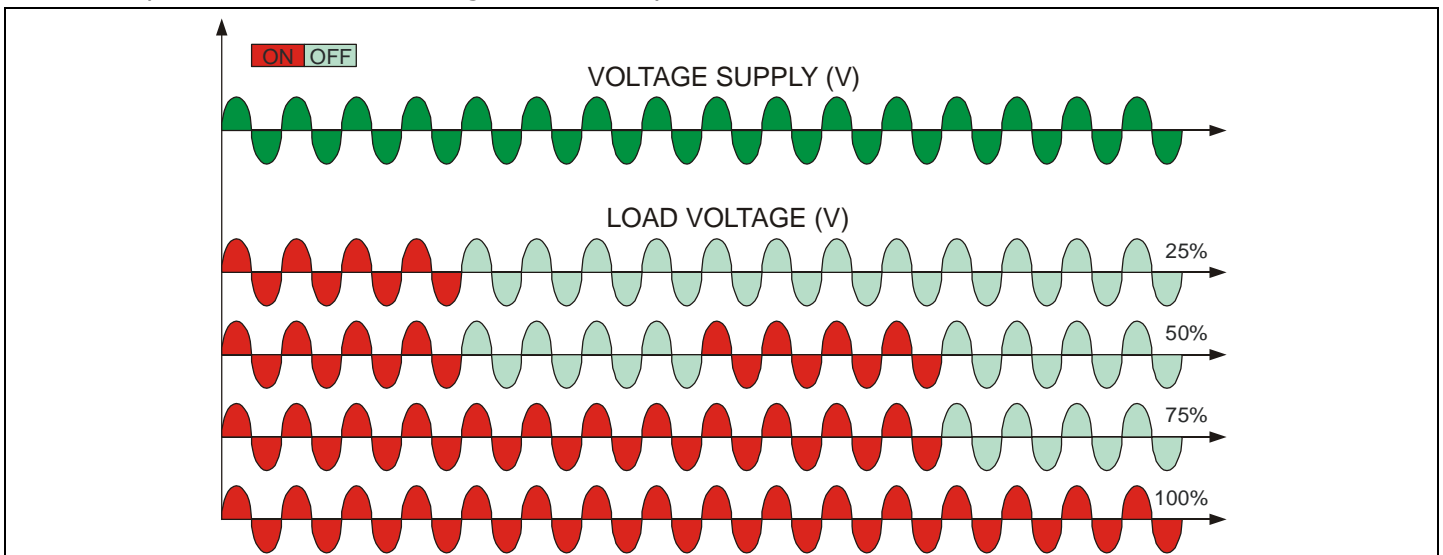

16 Feed-back type

The Feed-back type has already configured in line with customer requirements that are defined in the Order Code. The Order Code is written on the identification label. However, if you wish to change the Feed-back type you can use the software configurator or the Control Panel.



Caution: *this procedure must be performed only by qualified persons.*

The Feed-back type is defined by the parameter *FEED* .

If the configurable digital input has set like Feed-Back Selection ,it's possible to change the select Feed-Back with the Voltage Feed-Back (V) simply activating the input.

The feed-back defines the Control Mode. It's possible to have:

- **V** = Voltage feed-back.
The input signal is proportional to the output voltage. This means that input signal becomes a voltage demand. This control mode compensates the voltage fluctuation of the incoming line supply.
- **W** = Power feed-back.
The input signal is proportional to the power output. This means that input signal becomes a power demand. The power remains constant also if voltage and load impedance change. This control mode is used with silicon carbide elements that change its resistive value with temperature and with age. In addition it compensates the voltage fluctuation of the incoming line supply.
- **NO**=No Feedback Open Loop. The input is proportional to the firing angle (α).

Also available for special application.

- **I** = Current feed-back.
The input signal is proportional to the current output. This means that input signal becomes a current demand. This control mode maintain the current also if the load impedance changes.
- **V2** = Square Voltage feed-back.
The input signal is proportional to the output square voltage. This means that input signal becomes a power demand. The power remains constant if the load impedance doesn't change.

17 Electronic boards

17.1 How to access

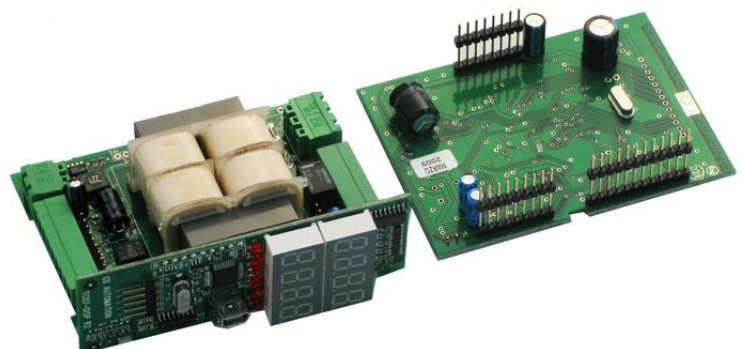
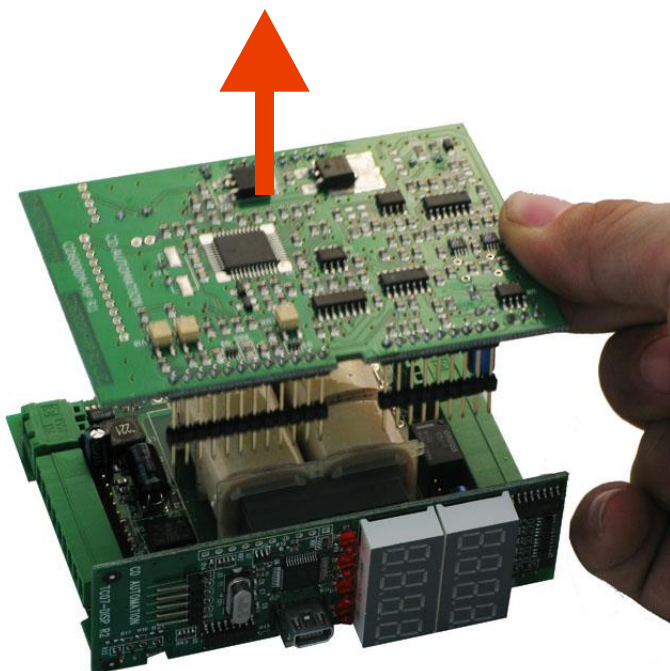
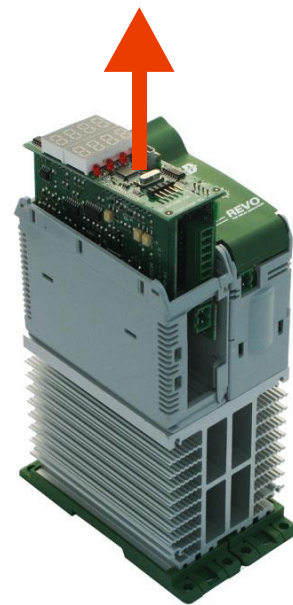
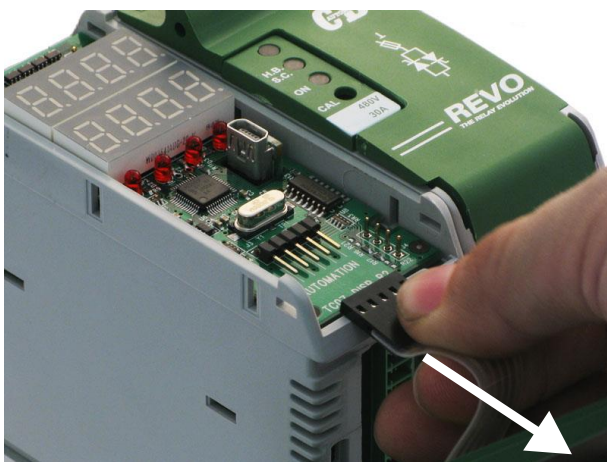
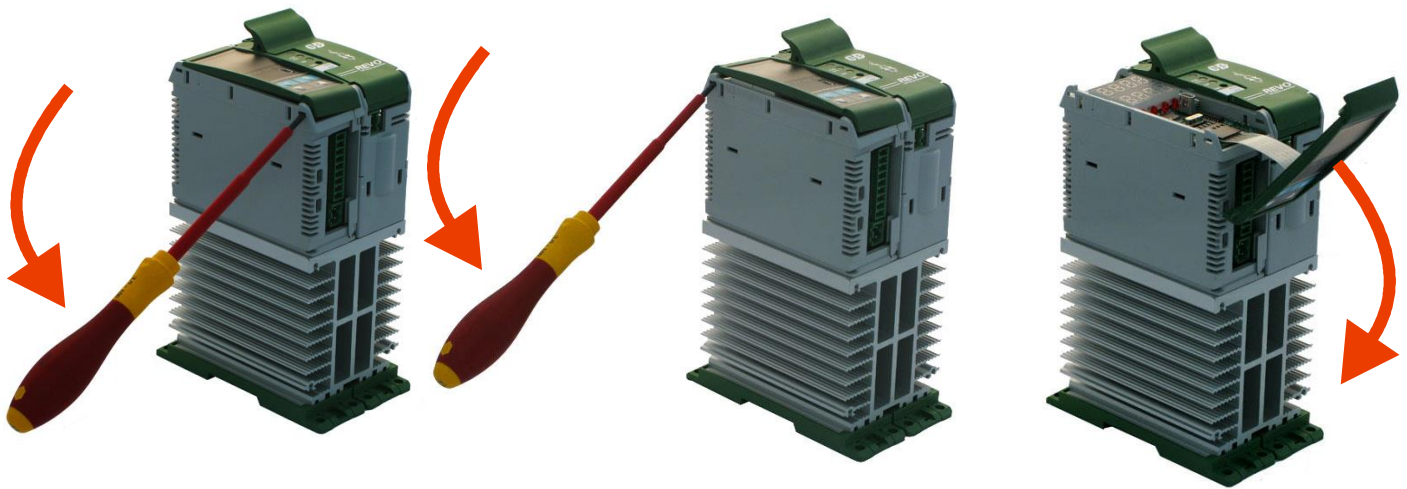

17.2 Supply the Electronic Board

The REVO M thyristor unit, to work, requires a voltage supply for the electronic boards. The Max consumption is 10VA.

The voltage supply for the electronic boards is configured in line with customer requirements that are defined in the Order Code. The Order Code is written on the identification label.



Warning: Before connecting or disconnecting the unit check that power and control cables are isolated from voltage sources.

Terminal M4	Description
1	Voltage Supply for Electronic Boards (Auxiliary Voltage)
2	Not Used
3	Voltage Supply for Electronic Boards (Auxiliary Voltage)

To change auxiliary supply voltage sold the correct link-jumper on Revo M board
The type of mounted transformer depends of the chosen Voltage in the order code.

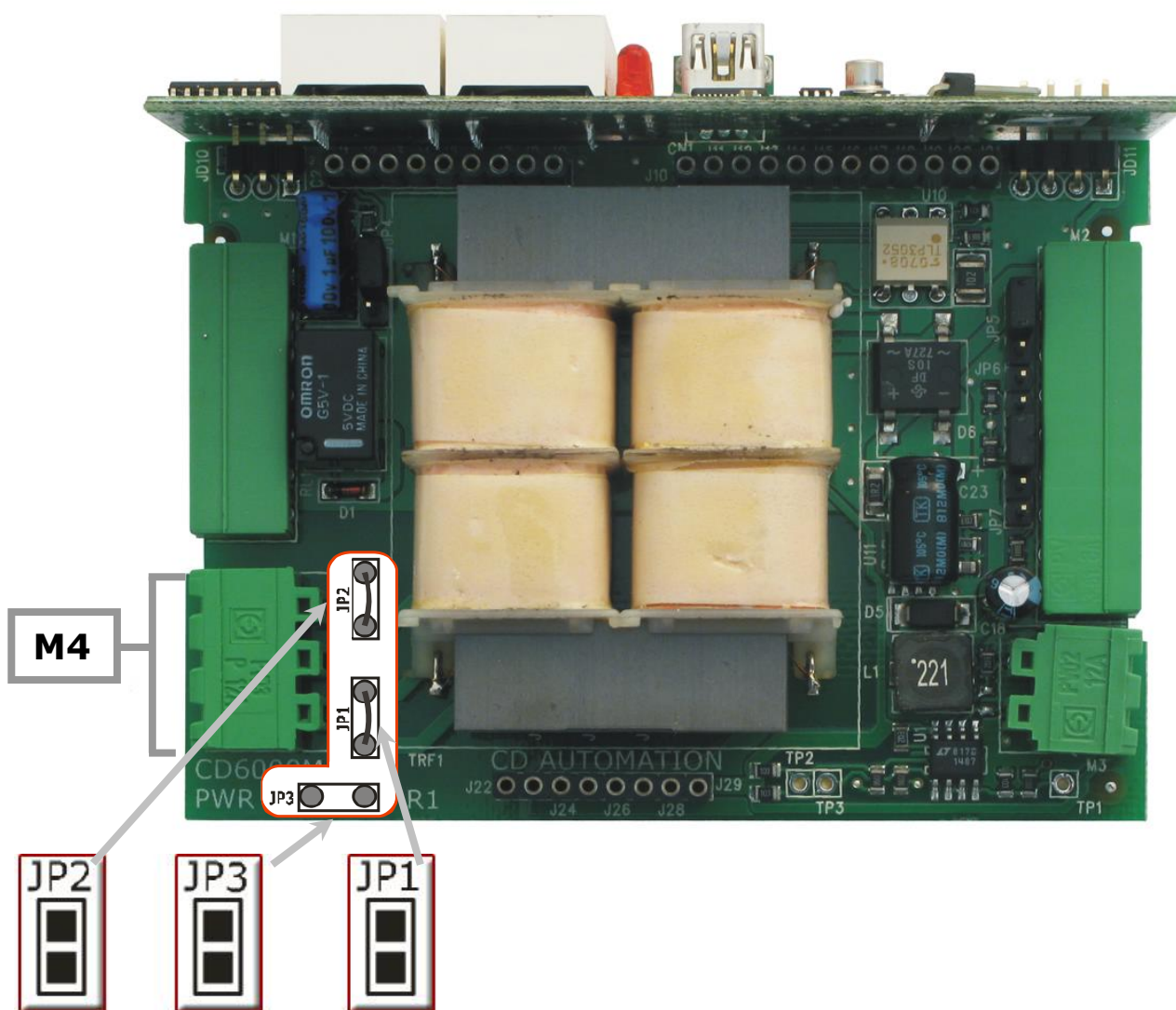

Trasformer Type	Link-Jumper JP1+JP2	Link-Jumper JP3
TR-605 120V	90:130V	170:265V
TR-605 230V	170:265V	300:530V
TR-605 300V	230:345V	510:690V

If the Auxiliary Voltage (written on the identification label) is different from Supply Voltage (to the load), use an external transformer with primary equal to load voltage and secondary equal to the Auxiliary Voltage

17.3 Analog Inputs Configuration

Primary Input (Terminals 5 and 6 of M2)

The primary input is already configured in line with customer requirements that are defined in the Order Code. The Order Code is written on the identification label.

However, if you wish to change the primary input (ex. from 0÷10V to 4÷20mA) proceed as follows:

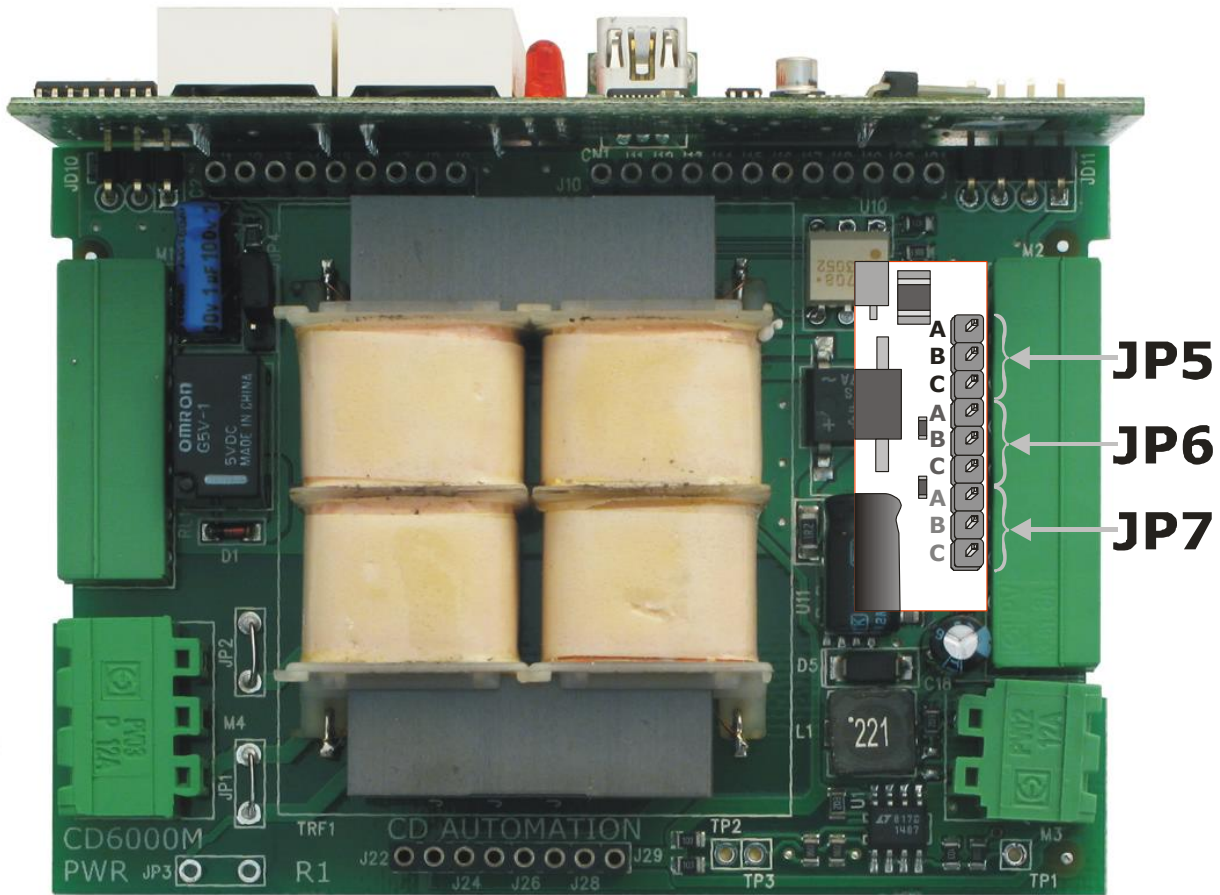

	0 ÷ 10	4 ÷ 20	SSR						
<table border="1"> <tr><td>A</td><td>■</td></tr> <tr><td>B</td><td>■</td></tr> <tr><td>C</td><td>■</td></tr> </table> JP5	A	■	B	■	C	■	A-B	A-B	B-C
A	■								
B	■								
C	■								
<table border="1"> <tr><td>A</td><td>■</td></tr> <tr><td>B</td><td>■</td></tr> <tr><td>C</td><td>■</td></tr> </table> JP6	A	■	B	■	C	■	B-C	B-C	A-B
A	■								
B	■								
C	■								
<table border="1"> <tr><td>A</td><td>■</td></tr> <tr><td>B</td><td>■</td></tr> <tr><td>C</td><td>■</td></tr> </table> JP7	A	■	B	■	C	■	B-C	A-B	-
A	■								
B	■								
C	■								

Type	Input features	
0÷10V (default)	Impedance	15KΩ
POT	Impedance	10KΩ min
4÷20mA	Impedance	100Ω

17.3.1 Primary Input calibration procedure

When you change the hardware setting is necessary make the Input calibration procedure.

To make the Input calibration procedure follow these steps:

- Give the power supply.
- With Control Panel go in the Hardware menu (*PRSS* = 5)
- Set the input signal to the min value (ex. 0V for 0÷10V or 4mA for 4÷20mA)
- Select the parameter *L* *IR* then press **F** (*L* *IR* Flashing)
- Press **Up** key (*SARU* on display)
- Press **F** key to confirm (*dEF* on display)
- Set the input signal to the max value (ex.10V for 0÷10V or 20mA for 4÷20mA)
- Select the parameter *H* *IR* then press **F** (*L* *IR* Flashing)
- Press **Up** key (*SARU* on display)
- Press **F** key to confirm (*dEF* on display)
- The Input calibration procedure is done.

18 PG Connector

The PG Connector is used to configure the thyristor unit with the configuration software and with the programming cable.
The programming cable is not included.

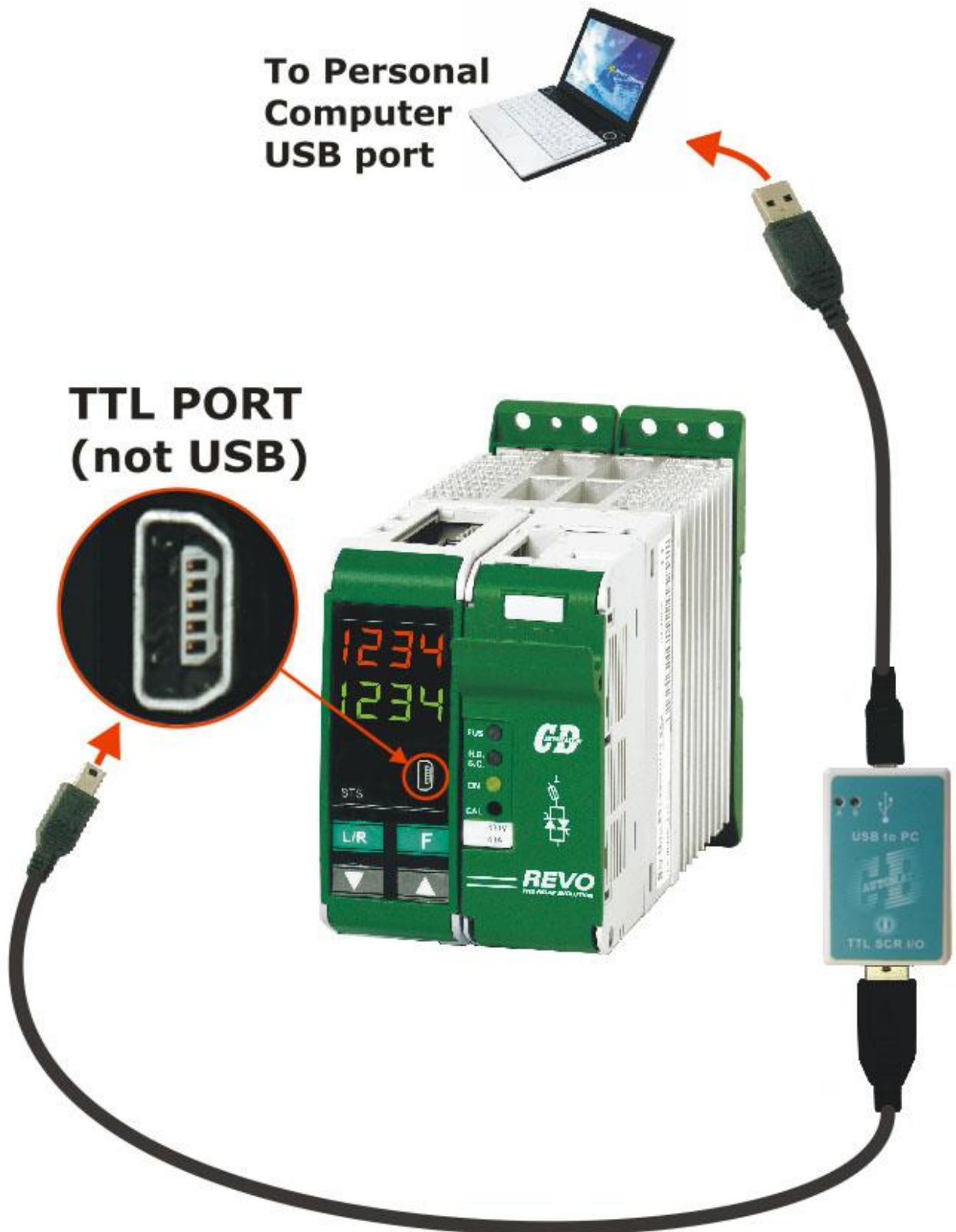

19 RS485 Serial Port

The serial communication port RS485 is available on the Command Terminals. On this port may be done a network up to 127 REVO M.

Terminal	Description
A+	RS485 A
B-	RS485 B

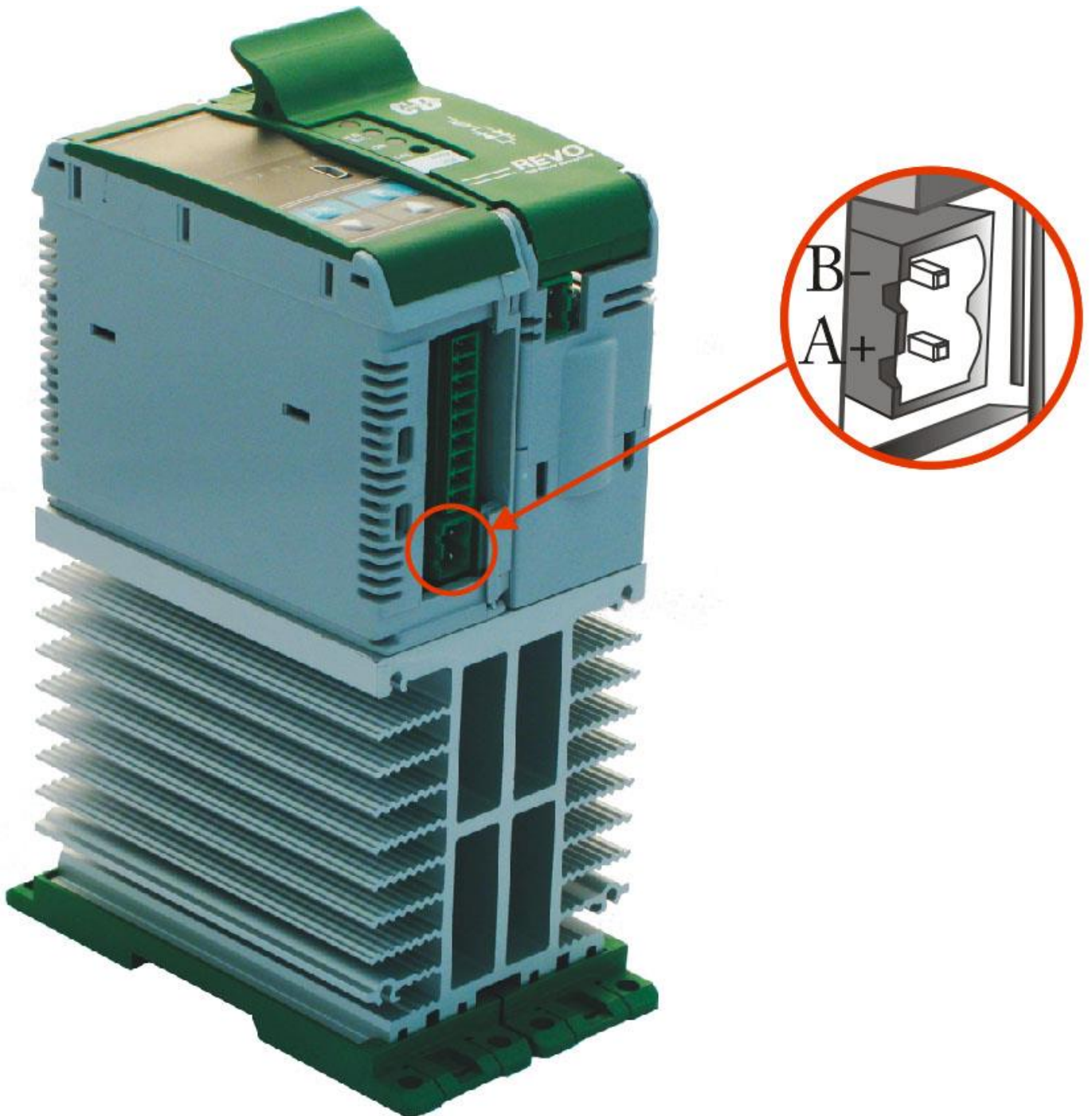

20 Internal Fuse

The thyristor unit have internal fuse extrarapid at low I²t for the thyristor protection of against the short-circuits.

The Fuses must have I²t 20% less than thyristor's I²t. The warranty of thyristor is null if no proper fuses are used.

Type	Fuse Code Spare Part	Current (ARMS)	I ² T at 500Vac* (A ² sec.)	Vac	Max Power Lost (W)
030	FU1451/40A	40	525	660	8
035	FU1451/50A	50	1260	660	9
040	FU1451/50A	50	1260	660	9

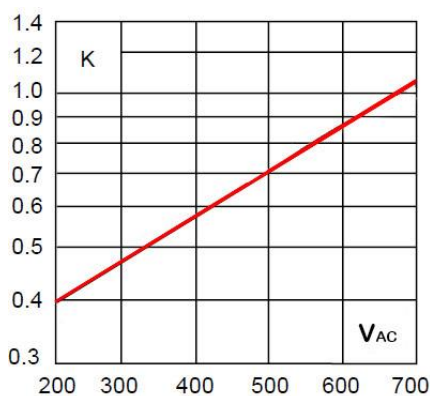

* I²T are multiplied for K value in function of Vac at 500V K is equal to 0,7 (750 X 0,7 = 525 1800 X 0,7 =1260).
At 660Vsc K is equal to 1.



Caution: High speed fuses are used only for the thyristor protection and can not be used to protect the installation.

Caution: The warranty of thyristor is null if no proper fuses are used. See tab.



Warning: When it is supply, the Thyristor unit is subject to dangerous voltage, don't open the Fuse-holder module and don't touch the electric equipments.

20.1 Fuses Replacement

Open the Fuse-Holder

Pull out the fuse

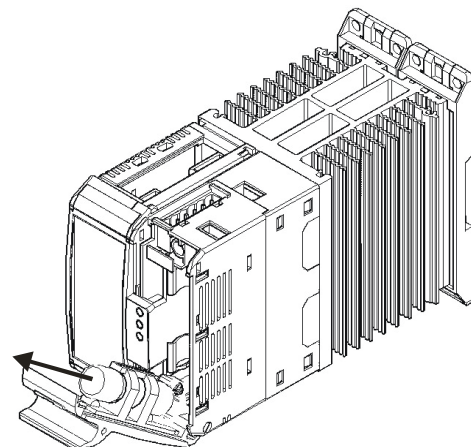
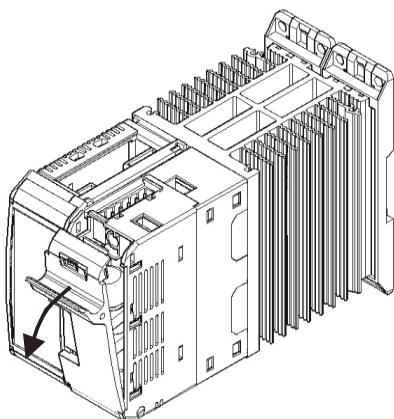

21 Maintenance

In order to have a corrected cooling, the user must clean the heat-sink and the protective grill of the fans. The frequency of this servicing depends on environmental pollution.

Also check periodically if the screw for the power cables and safety earth are tightened correctly (See Connection Diagram)

21.1 Trouble Shooting

Small problems sometimes can be solved locally with the help of the below tab of trouble shooting. If you don't succeed, contact us or your nearest distributor.

Symptom	Indication on front unit	Possible reasons of the symptom	Actions
Load current doesn't flow	Green LED (ON) light OFF	<ul style="list-style-type: none"> No Auxiliary Voltage No input signal Reversed polarities of input signal 	<ul style="list-style-type: none"> Give auxiliary voltage supply (See Connection Diagram) Provide to give input signal Reverse the input signal polarity
	Green LED (ON) light ON	<ul style="list-style-type: none"> Fuse failure Load connection interruption Load failure: The yellow led (HB) is light on (with HB option) Thyristor fault: The red led (SC) is light on (with HB option) 	<ul style="list-style-type: none"> Change the fuse Check the wiring Check the load Change the thyristor module
Load current flow also without input signal	Red LED (SC) light on	<ul style="list-style-type: none"> Wrong wiring SCR short circuit 	<ul style="list-style-type: none"> Check the wiring Change the thyristor module
Current flows at nominal value but Yellow LED (HB/SC) is light on	Yellow LED (HB) light on or Red LED (SC) light on	<ul style="list-style-type: none"> HB circuit not tuned Current transformers not properly wired 	<ul style="list-style-type: none"> Make HB calibration procedure Check current transformers wiring
Thyristor unit doesn't work properly		<ul style="list-style-type: none"> Auxiliary voltage supply out of limits Wrong input signal selection. Wrong input signal calibration (out of range) 	<ul style="list-style-type: none"> Verify the auxiliary voltage supply Control input signal setting. Check input setting

21.2 Warranty condition

CD Automation gives a 12 months warranty to its products. The warranty is limited to repairing and parts substitution in our factory and does exclude products not properly used and fuses. Warranty does not include products with serial numbers deleted. The faulty product should be shipped to CD Automation at customer's cost and our Service will evaluate if product is under warranty terms. Substituted parts remain of CD Automation property.



