

Solid State Relays, 3-phase

Zero-Point switching, heatsink integrated

Main Characteristics:

Three-phase controlled
 Zero switching
 LED display
 Various connection technologies
 Plug-in control terminal
 Degree of protection IP 20
 Insulated mounting foot



Standards / Approvals:

DIN EN 60947-4-3
 UL 508 / CSA¹
 CE
 C-Tick

Ordering Key:

3RF24	10	- 1	A	C	4	5
3-phase solid state contactor with heat sink	Max. load current 10 = 10,5 A 20 = 22 A 30 = 30 A 40 = 40 A 50 = 50 A	Connection technology 1 = Screw connection 2 = Spring-loaded connection 3 = Ring cable connection M5	Switching function A = Zero-point switching	Controlled phases C = three-phase	Control voltage 4 = 4 - 30 VDC 5 = 190 - 230 VAC	Operating voltage 5 = 48 - 600 V

Not all possible versions are available ex stock!

Main Circuit:

Values for 40 °C ambient temperature!	I_{AC-51}	I_e acc. to IEC947-4-3	I_e [50°C] UL/CSA	Power loss with I_{AC-51}	Min. load current	Max. leakage current
Type	A	A	A	W	A	mA
3RF2410-.A.C.	10,5	7	7	31	0,1	10
3RF2420-.A.C.	22	15	15	66	0,5	
3RF2430-.A.C.	30	22	22	91		
3RF2440-.A.C.	40	30	30	121		
3RF2450-.A.C.	50	38	38	160		

Type		3RF24...A.C.5
Rated operating voltage U_e	V	48 ... 600
	V	40 ... 660
	Hz	50/60 ± 10 %
Rated insulation voltage U_i	V	600
Rated impulse withstand voltage U_{imp}	kV	6
Slew rate	V/µs	1000

	Rated impulse withstand strength I_{tsm}	I^2t value	Blocking voltage
Type	A	A ² s	V
3RF2410-.A.C.	300	450	1200
3RF2420-.A.C.	600	1800	1200
3RF2430-.A.C.	1200	7200	1200
3RF2440-.A.C.	1150	6600	1600
3RF2450-.A.C.	1150	6600	1600

¹ Use overvoltage protection device; max cut-off-voltage 6.000 V; min energy handling capability 100 J

Control Circuit A1-A2:			
Type		3RF24... AC 5.	3RF24... AC 4.
Control voltage U_s	V	AC 190 ... 230	DC 4 ... 30
Max. control voltage U_s	V	253	30
Typical operating current	mA	15	30
Response voltage	V	180	4
Drop-out voltage	V	<40	<1
Rated frequency of the control supply voltage	Hz	50/60 \pm 10 %	--
Switching times ON delay	ms	40 + Max. one half-wave	1 + Max. one half-wave
OFF delay	ms	40 + Max. one add. half-wave	1 + Max. one add. half-wave

General Data:		
Ambient temperature		
During operation	°C	-25 ... 60
During storage	°C	-55 ... 80
Mounting altitude	m	0 ... 1000; at > 1000 m, please contact our Technical Assistance
Impact resistance acc. to DIN IEC 68	g/ms	15/11
Vibration resistance	g	2
Degree of protection		IP20
Electromagnetic compatibility (EMC)		
Interference emission		
○ Conducted interference voltage IEC 60 947-4-3		Class A for industrial applications ²
○ Radiated, high-frequency interference voltage IEC 60 947-4-3		Class A for industrial applications
Interference resistance		
○ Electrostatic discharge acc. to IEC 61 000-4-2 (corresponds to severity 3)	kV	Contact discharge 4; air discharge 8; performance criterion 2
○ Induced HF fields acc. to IEC 61 000-4-6	MHz	0.15 ... 80; 140 dB μ V; performance criterion 1
○ Burst acc. to IEC 61 000-4-4	kV	2/5.0 kHz; performance criterion 1
○ Surge acc. to IEC 61 000-4-5	kV	Phase-to-ground 2; phase-to-phase 1; performance criterion 2
Dielectric Strength 50/60 Hz (Input, Output / Base)	V rms	4000

² **Attention!**

This product was constructed as an EMC Class A device. The use of this product in residential applications could lead to radio interferences. In such an application, additional filtering may be required.

Type		3RF24...-1.	3RF24...-2.	3RF24...-3.
Connection, main contacts		Screw connection	Spring-loaded connection	Ring cable connection
Conductor cross-section				
○ Solid	mm ²	2 x (1.5 ... 2.5), 2 x (2.5 ... 6)	2x (0.5 ... 2.5)	
○ Finely stranded with end sleeve	mm ²	2 x (1.5 ... 2.5), 2 x (2.5 ... 6), 1 x 10	2x (0.5 ... 1.5)	
○ Finely stranded w/o end sleeve	mm ²		2x (0.5 ... 2.5)	
○ Solid or stranded	AWG	2 x (14 ... 10)	2 x (18 ... 14)	
Stripping length	mm	10	10	
Terminal screw		M 4	-	M 5
○ Tightening torque	Nm	2 ... 2.5	-	2 ... 2.5
D 5...6 mm / PZ 2	lb.in	18 ... 22	-	18 ... 22
Cable lug	DIN	-	-	DIN 46234 5-2.5 ... 5-25
	JIS	-	-	JIS C 2805 R 2-5 ... 14-5
Connection, control contacts				
Conductor cross-section with or without end sleeve	mm ²	1 x (0.5 ... 2.5)	0.5 ... 2.5	1 x (0.5 ... 2.5)
	mm ²	2 x (0.5 ... 1.0)		2 x (0.5 ... 1.0)
	AWG	20 ... 12	20 ... 12	20 ... 12
Stripping length	mm	7	10	7
Terminal screw		M 3	-	M 3
○ Tightening torque	Nm	0.5 ... 0.6	-	0.5 ... 0.6
D 3.5 / PZ 1	lb.in	4.5 ... 5.3	-	4.5 ... 5.3

Fused Design with Semiconductor Protection

Type	Full-range fuse LV HBC design gR/SITOR	Semiconductor protection fuse LV HBC design aR / 3NE80	Semiconductor protection fuse, cylindrical design		
			10 x 38 mm aR / SITOR	14 x 51 mm aR / SITOR	22 x 58 mm aR / SITOR
3RF2410-.AC.	3NE1813-0	3NE8015-1	3NC1012	3NC1415	3NC2220
3RF2420-.AC.	3NE1814-0	3NE8015-1	3NC1025	3NC1425	3NC2225
3RF2430-.AC.	3NE1803-0	3NE8003-1	3NC1032	3NC1432	3NC2232
3RF2440-.AC.	3NE1802-0	3NE8017-1	-	3NC1450	3NC2250
3RF2450-.AC.	3NE1817-0	3NE8018-1	-	3NC1450	3NC2263

Accessories

Function module	Order No.	Applicable for	Versions
Converter	3RF2900-0EA18	3RF24...-AC 4.	Us = DC 24 V

Characteristic Curves

3RF2410-

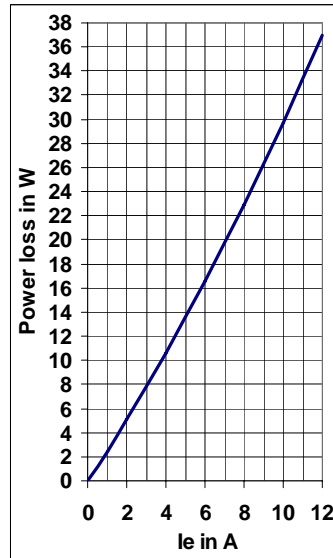
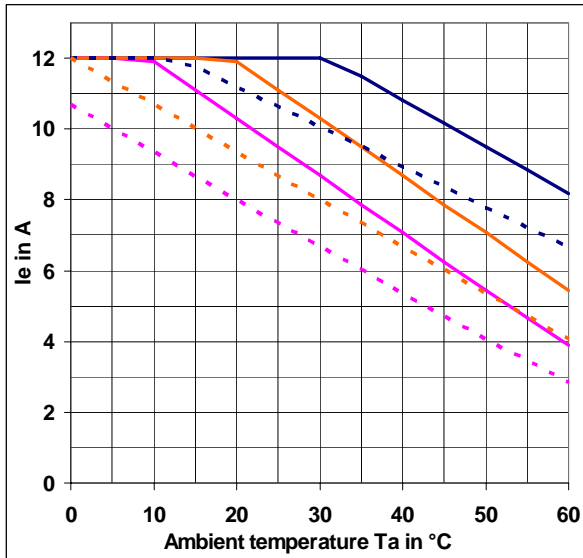

Upper curves:
 I_{max} thermal limit current
Middle curves:
 Rated current I_e acc. to UL
Lower curves:
 Rated current I_e
 acc. to
 DIN EN 60947-4-3

Continuous lines:
 Stand-alone mounting
Dashed lines:
 Side-by-side mounting

3RF2420-

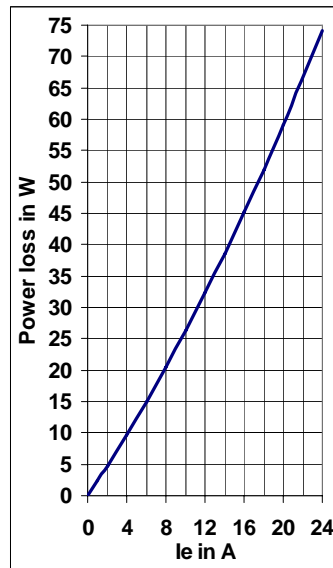
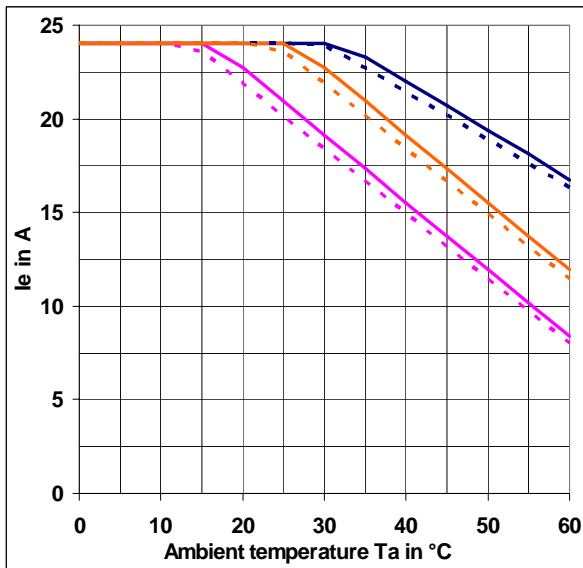

3RF2430-³

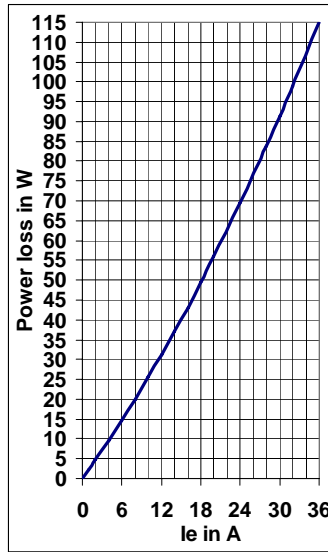
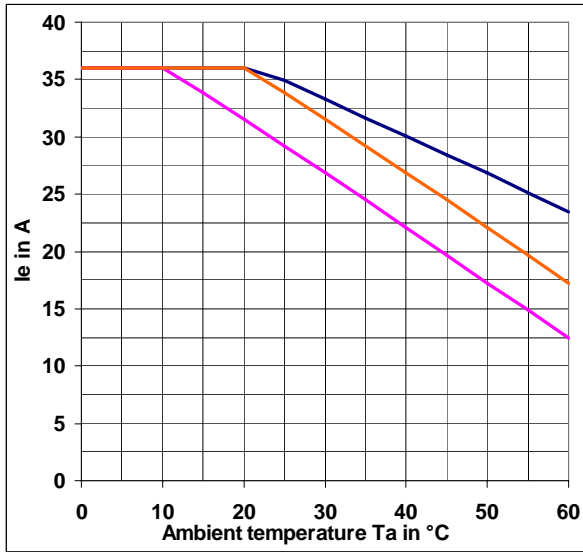

Upper curves:
 I_{max} thermal limit current
Middle curves:
 Rated current I_e acc. to UL
Lower curves:
 Rated current I_e
 acc. to
 DIN EN 60947-4-3

Stand-alone and side-by-side mounting

3RF2440-³

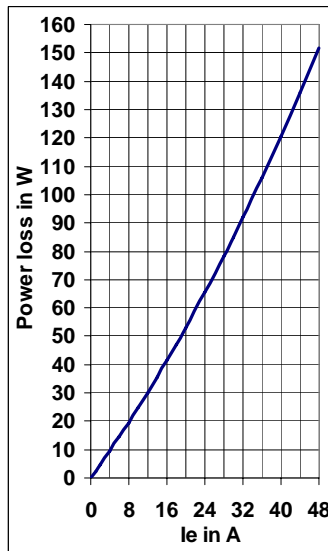
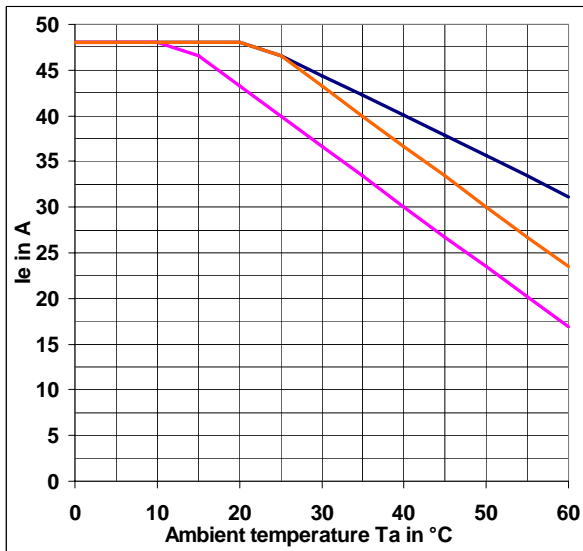

3RF2450-³

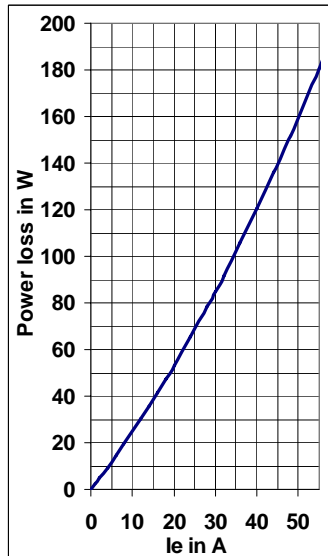
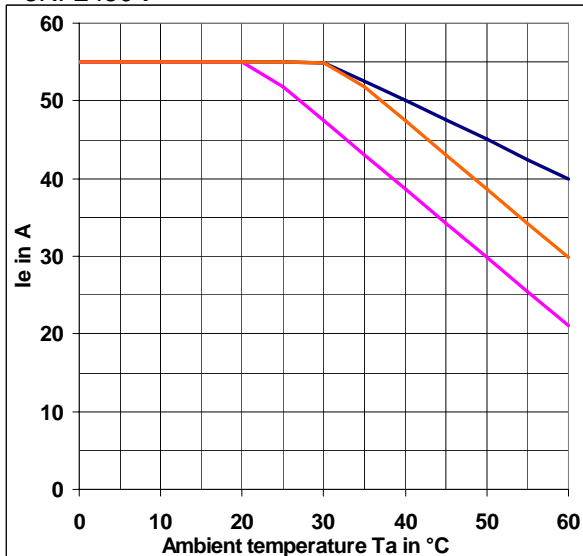

Mounting Instructions⁴:

³ Identical current/temperature curves for Stand-alone and side by side mounting.

3RF2410-AB..., 3RF2410-AC...,
3RF2420-AB..., 3RF2420-AC...,
3RF2430-AB..

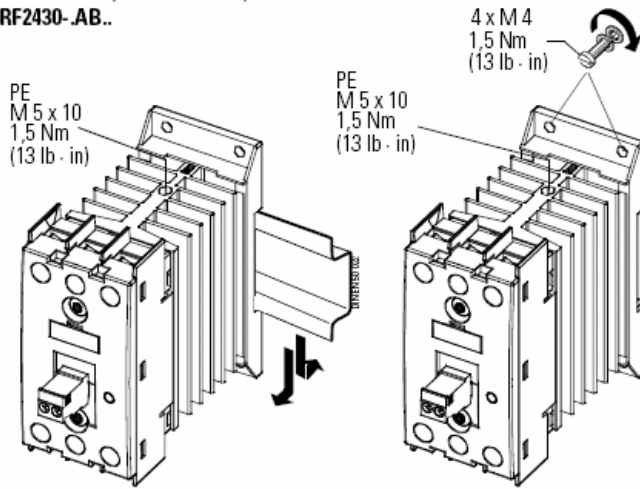

3RF2430-AC..
3RF2440-AB..., 3RF2440-AC...,
3RF2450-AB..., 3RF2450-AC..

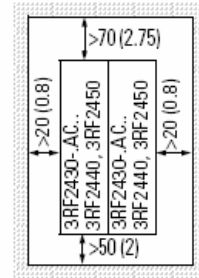
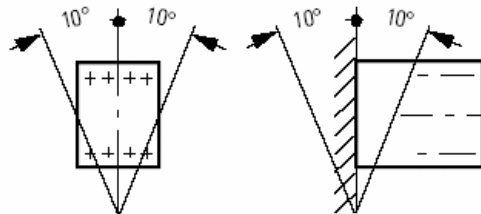
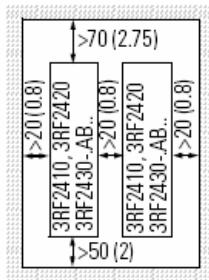
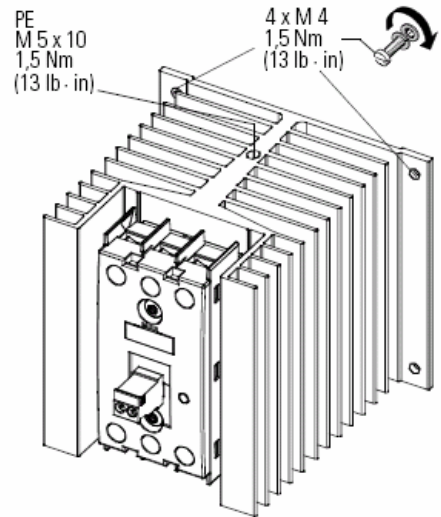

Device / Example Circuit Diagram:

3RF24...-AC4.

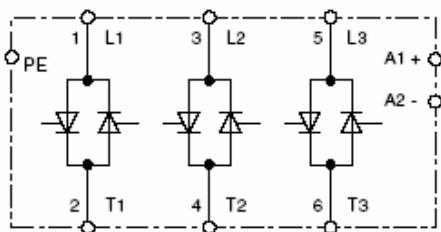

DC 4... 30 V

3RF24...-AC5.

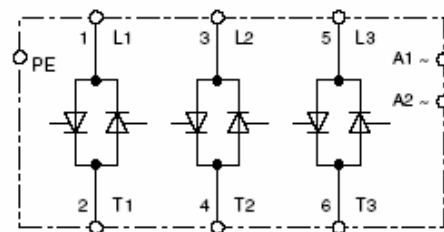

AC 230 V

⁴ Dimensions in mm, (in);

Stand alone mounting, Characteristic Curves shows derating for Side-by-side mounting

Subject to changes

Dimension Drawings⁵:

3RF2410-.AB., 3RF2410-.AC.,
3RF2420-.AB., 3RF2420-.AC.,
3RF2430-.AB..

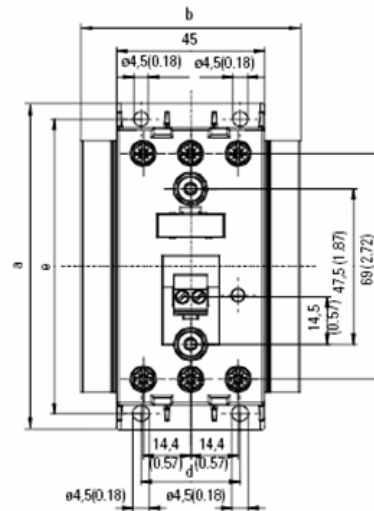
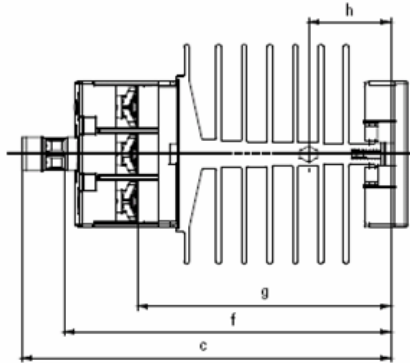

3RF2430-.AC.,
3RF2440-.AB., 3RF2440-.AC.,
3RF2450-.AB., 3RF2450-.AC..

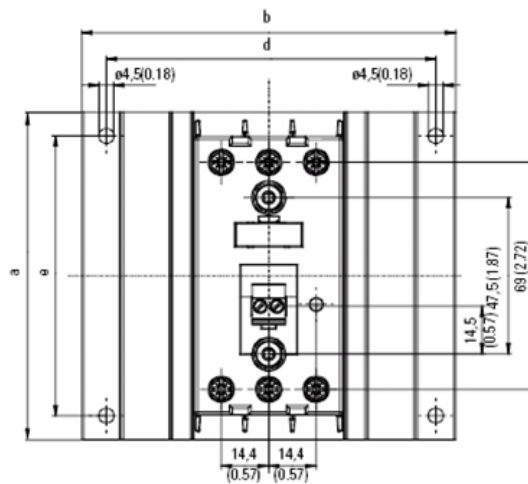
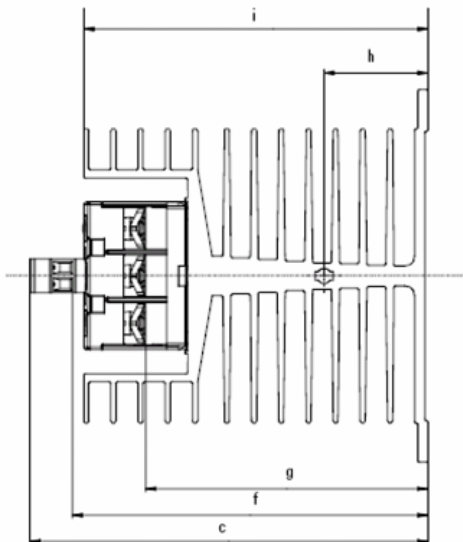

	a	b	c	d	e	f	g	h	i
3RF2410-.AC., 3RF2410-.AB..	100 (3.94)	45 (1.77)	104,5 (4.11)	30 (1.18)	90 (3.54)	91,5 (3.60)	69,5 (2.74)	25 (0.98)	–
3RF2420-.AB., 3RF2420-.AC., 3RF2430-.AB..	100 (3.94)	67 (2.64)	112,5 (4.43)	30 (1.18)	90 (3.54)	99,5 (3.92)	77 (3.03)	25 (0.98)	–
3RF2430-.AC., 3RF2440-.AB., 3RF2440-.AC., 3RF2450-.AB., 3RF2450-.AC..	100 (3.94)	113,5 (4.47)	121 (4.76)	100 (3.94)	85 (3.35)	108 (4.25)	86 (3.39)	31,5 (1.24)	104,5 (4.11)
3RF2440-.AC., 3RF2450-.AB., 3RF2450-.AC..	100 (3.94)	157,5 (6.20)	121 (4.76)	146 (5.75)	80 (3.15)	108 (4.25)	86 (3.39)	31,5 (1.24)	104,5 (4.11)
3RF2450-.AC..	180 (7.09)	157,5 (6.20)	121 (4.76)	146 (5.75)	160 (6.30)	108 (4.25)	86 (3.39)	31,5 (1.24)	104,5 (4.11)

⁵ Dimensions in mm, (in)



PMA

Prozeß- und Maschinen- Automation GmbH
P.O. Box 31 02 29
D-34058 Kassel
Tel.: +49 - 561- 505 1307
Fax: +49 - 561- 505 1710
E-mail: mailbox@pma-online.de
Internet: <http://www.pma-online.de>

Your local representative: