

Uni-I/O™ Modules

Installation Guide UIS-04PTN, UIS-04PTKN

Uni-I/O™ is a family of Input/Output modules that are compatible with the UniStream™ control platform.

This guide provides basic installation information for the UIS-04PTN and UIS-04PTKN module.

Technical specifications may be downloaded from the Unitronics website.

The UniStream™ platform comprises CPU controllers, HMI panels, and local I/O modules that snap together to form an all-in-one Programmable Logic Controller (PLC).

Install Uni-I/O™ modules:

- Onto the back of any UniStream™ HMI Panel comprising a CPU-for-Panel.
- Onto a DIN-rail, using a Local Expansion Kit.

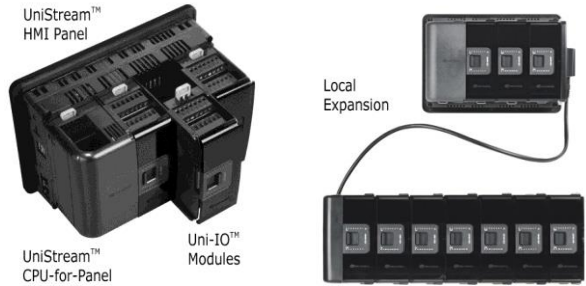

The maximum number of Uni-I/O™ modules that can be connected to a single CPU controller is limited. For details, please refer to the specification sheets of the UniStream™ CPU or any of the relevant Local Expansion Kits.

Before You Begin

Before installing the device, the installer must:

- Read and understand this document.
- Verify the Kit Contents.



Installation option requirements

If you are installing a Uni-I/O™ module onto:

- A UniStream™ HMI Panel; the Panel must comprise a CPU-for-Panel, installed according to the CPU-for-Panel installation guide.
- A DIN-rail; you must use a Local Expansion Kit, available by separate order, to integrate the Uni-I/O™ modules on the DIN-rail into a UniStream™ control system.

Alert Symbols and General Restrictions

When any of the following symbols appear, read the associated information carefully.

Symbol	Meaning	Description
	Danger	The identified danger causes physical and property damage.
	Warning	The identified danger could cause physical and property damage.
Caution	Caution	Use caution.

- All examples and diagrams are intended to aid understanding, and do not guarantee operation. Unitronics accepts no responsibility for actual use of this product based on these examples.
- Please dispose of this product according to local and national standards and regulations.
- This product should be installed only by qualified personnel.



- Failure to comply with appropriate safety guidelines can cause severe injury or property damage.
- Do not attempt to use this device with parameters that exceed permissible levels.
- Do not connect/disconnect the device when power is on.

Environmental Considerations



- Ventilation: 10mm (0.4”) of space is required between the device top/bottom edges and the enclosure’s walls.
- Do not install in areas with: excessive or conductive dust, corrosive or flammable gas, moisture or rain, excessive heat, regular impact shocks or excessive vibration, in accordance with the standards and limitations given in the product’s technical specification sheet.
- Do not place in water or let water leak onto the unit.
- Do not allow debris to fall inside the unit during installation.
- Install at maximum distance from high-voltage cables and power equipment.

Kit Contents

- 1 Uni-I/O™ module
- 2 I/O terminal blocks (black)

Uni-I/O™ Diagram

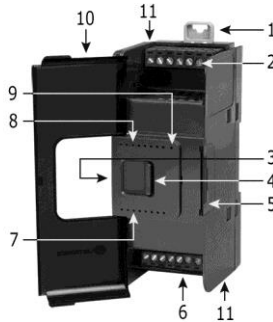

1	DIN-rail clips	Provide physical support for CPU and modules. There are two clips: one at the top (shown), one at the bottom (not shown).
2	Inputs 0-1	Input connection points
3	I/O Bus - Left	Left-side Connector
4	Bus Connector Lock	Slide the Bus Connector Lock to the left, to electrically connect the Uni-I/O™ module to the CPU or adjacent module.
5	I/O Bus - Right	Right-Side Connector, shipped covered. Leave covered when not in use.
	Bus Connector Cover	
6	Inputs 2-3	Input connection points
7	Input LEDs (2-3)	Red LEDs
8	Input LEDs (0-1)	Red LEDs
9	Status LED	Tricolor LED, Green/Red/Orange

NOTE ■ Refer to the module's specification sheet for LED indications.

10	Module door	Shipped covered with protective tape to prevent the door from being scratched. Remove tape during installation.
11	Screw holes	Enable panel-mounting; hole diameter: 4mm (0.15").

About the I/O Bus Connectors

The I/O Bus connectors provide the physical and electrical connection points between modules. The connector is shipped covered by a protective cover, protecting the connector from debris, damage, and ESD.

The I/O Bus - Left (#3 in diagram) can be connected to either a CPU-for-Panel, a Uni-COM™ module, to another Uni-I/O™ module or to the End Unit of a Local Expansion Kit.

The I/O Bus - Right (#5 in diagram) can be connected to another I/O module, or to the Base Unit of the Local Expansion Kit.

Caution ■ If the I/O module is located last in the configuration, and nothing is to be connected to it, do not remove its Bus Connector Cover.

Installation

- ⚠ ■ Turn off system power before connecting or disconnecting any modules or devices.
- Use proper precautions to prevent Electro-Static Discharge (ESD).

Installing a Uni-I/O™ Module onto a UniStream™ HMI Panel

NOTE The DIN-rail type structure on the back of the panel provides the physical support for the Uni-I/O™ module.

1. Check the unit to which you will connect the Uni-I/O™ module to verify that its Bus Connector is not covered.
If the Uni-I/O™ module is to be the last one in the configuration, do not remove the cover of its I/O Bus Connector - Right.
2. Open the door of the Uni-I/O™ module and hold it as shown in the accompanying figure.
3. Use the upper and lower guide-tunnels (tongue & groove) to slide the Uni-I/O™ module into place.
4. Verify that the DIN-rail clips located at the top and bottom of the Uni-I/O™ module have snapped onto the DIN-rail.

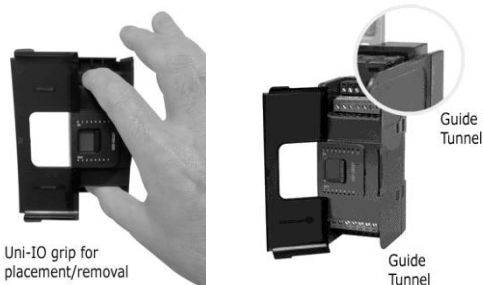

- Slide the Bus Connector Lock all the way to the left as shown in the accompanying figure.
- If there is already a module located to its right, complete the connection by sliding the Bus Connector lock of the adjacent unit to the left.
- If the module is the last in the configuration, leave the I/O bus connector covered.

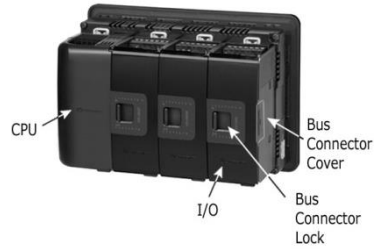

Removing a Module

- Turn off the system power.
- Disconnect the I/O terminals (#2, 6 in the diagram).
- Disconnect the Uni-I/O™ module from the adjacent units: slide its Bus Connector Lock to the right. If there is a unit located on its right, slide the lock of this module to the right as well.
- On the Uni-I/O™ module, pull the top DIN-rail clip up and the bottom clip down.
- Open the door of the Uni-I/O™ and hold it with two fingers as shown in the figure on page 3; then pull it carefully from its place.

Installing Uni-I/O™ modules onto a DIN-rail

To mount modules onto a DIN-rail, follow steps 1-7 in Installing a Uni-I/O™ Module onto a UniStream™ HMI Panel on page 3.

In order to connect the modules to a UniStream™ controller, you must use a Local Expansion Kit.

These kits are available with and without power supplies, and with cables of varying lengths. For complete information, please refer to the installation guide of the relevant Local Expansion Kit.

Numbering Modules

You can number modules for reference purposes. A set of 20 stickers is provided with every CPU-for-Panel; use these stickers to number the modules.



- The set contains numbered and blank stickers as shown in the figure to the left.
- Place them on the modules as shown in the figure to the right.



Wiring



- This equipment is designed to operate only at SELV/PELV/Class 2/Limited Power environments.
- All power supplies in the system must include double insulation. Power supply outputs must be rated as SELV/PELV/Class 2/Limited Power.
- Do not connect either the 'Neutral' or 'Line' signal of the 110/220VAC to device's 0V point.
- Do not touch live wires.



- All wiring activities should be performed while power is OFF.
- Unused points should not be connected (unless otherwise specified). Ignoring this directive may damage the device.
- Double-check all wiring before turning on the power supply.

- Caution**
- To avoid damaging the wire, use a maximum torque of 0.5 N·m (5 kgf·cm).
 - Do not use tin, solder, or any substance on stripped wire that might cause the wire strand to break.
 - Install at maximum distance from high-voltage cables and power equipment.

Wiring Procedure

Use crimp terminals for wiring; use 26-12 AWG wire (0.13 mm² –3.31 mm²).

1. Strip the wire to a length of 7±0.5mm (0.250–0.300 inches).
2. Unscrew the terminal to its widest position before inserting a wire.
3. Insert the wire completely into the terminal to ensure a proper connection.
4. Tighten enough to keep the wire from pulling free.

Uni-I/O™ Connection Points

All wiring diagrams and instructions in this document refer to the Uni-I/O™ connection points.

These points are arranged in two groups of 2 points as shown in the figure to the right.

Top group

Input connection points (0-1)

Bottom group

Input connection points (2-3)

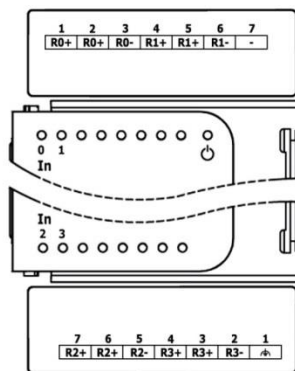

Wiring Guidelines

In order to ensure that the device will operate properly and to avoid electromagnetic interference:

- Use a metal cabinet. Make sure the cabinet and its doors are properly earthed.
- Use wires that are properly sized for the load.
- Use shielded cables for wiring RTD signals; do not use the cable shield as a signal common (CM) / return path.
- Individually connect each functional ground point (⚡) to the earth of the system (preferably to the metal cabinet chassis).
Use the shortest and thickest wires possible: less than 1m (3.3') in length, minimum thickness 14 AWG (2 mm²).
- Earthing the cables' shield:
 - Connect the cable shield to the earth of the system - preferably to the metal cabinet chassis. Note that the shield must be connected only at one end of the cable; typically, earthing the shield at the Uni-I/O™ end performs better.
 - Keep shield connections as short as possible.
 - Ensure shield continuity when extending shielded cables.

NOTE For detailed information, refer to the document System Wiring Guidelines, located in the Technical Library in the Unitronics' website.

Wiring the RTD Inputs

- NOTE**
- The inputs are not isolated.
 - When connecting 3- or 4-wire RTDs, make sure to use conductors of the same type, width, and length for all RTD wires, otherwise module accuracy will degrade.
 - When connecting 4-wire RTDs, use 3-wire cable and leave the unused wire unconnected with minimal length.

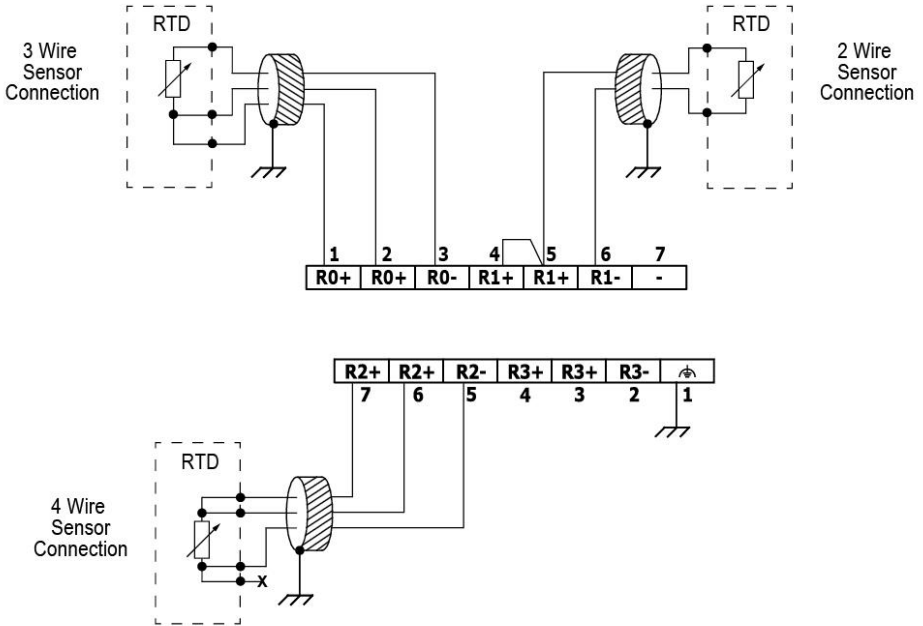

The information in this document reflects products at the date of printing. Unitronics reserves the right, subject to all applicable laws, at any time, at its sole discretion, and without notice, to discontinue or change the features, designs, materials and other specifications of its products, and to either permanently or temporarily withdraw any of the foregoing from the market.

All information in this document is provided "as is" without warranty of any kind, either expressed or implied, including but not limited to any implied warranties of merchantability, fitness for a particular purpose, or non-infringement. Unitronics assumes no responsibility for errors or omissions in the information presented in this document. In no event shall Unitronics be liable for any special, incidental, indirect or consequential damages of any kind, or any damages whatsoever arising out of or in connection with the use or performance of this information.

The tradenames, trademarks, logos and service marks presented in this document, including their design, are the property of Unitronics (1989) (R"G) Ltd. or other third parties and you are not permitted to use them without the prior written consent of Unitronics or such third party as may own them.

Uni-I/O™ is a family of Input/Output modules that are compatible with the UniStream™ control platform.

This guide provides basic installation information for the UIS-08TC module. Technical specifications may be downloaded from the Unitronics website.

The UniStream™ platform comprises CPU controllers, HMI panels, and local I/O modules that snap together to form an all-in-one Programmable Logic Controller (PLC).

Install Uni-I/O™ modules:

- Onto the back of any UniStream™ HMI Panel comprising a CPU-for-Panel.
- Onto a DIN-rail, using a Local Expansion Kit.

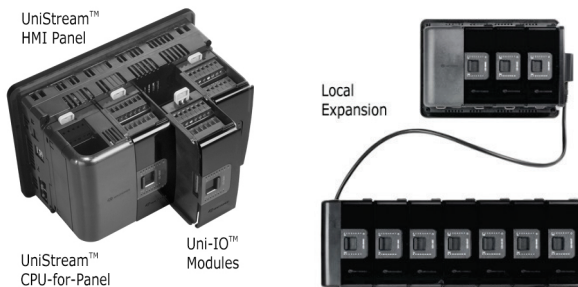

The maximum number of Uni-I/O™ modules that can be connected to a single CPU controller is limited. For details, please refer to the specification sheets of the UniStream™ CPU or any of the relevant Local Expansion Kits.

Before You Begin

Before installing the device, the installer must:

- Read and understand this document.
- Verify the Kit Contents.



Installation option requirements

If you are installing a Uni-I/O™ module onto:

- A UniStream™ HMI Panel; the Panel must comprise a CPU-for-Panel, installed according to the CPU-for-Panel installation guide.
- A DIN-rail; you must use a Local Expansion Kit, available by separate order, to integrate the Uni-I/O™ modules on the DIN-rail into a UniStream™ control system.

Alert Symbols and General Restrictions

When any of the following symbols appear, read the associated information carefully.

Symbol	Meaning	Description
	Danger	The identified danger causes physical and property damage.
	Warning	The identified danger could cause physical and property damage.
	Caution	Use caution.

- All examples and diagrams are intended to aid understanding, and do not guarantee operation. Unitronics accepts no responsibility for actual use of this product based on these examples.
- Please dispose of this product according to local and national standards and regulations.
- This product should be installed only by qualified personnel.



- Failure to comply with appropriate safety guidelines can cause severe injury or property damage.
- Do not attempt to use this device with parameters that exceed permissible levels.
- Do not connect/disconnect the device when power is on.

Environmental Considerations



- Ventilation: 10mm (0.4") of space is required between the device top/bottom edges and the enclosure's walls.
- Do not install in areas with: excessive or conductive dust, corrosive or flammable gas, moisture or rain, excessive heat, regular impact shocks or excessive vibration, in accordance with the standards and limitations given in the product's technical specification sheet.
- Do not place in water or let water leak onto the unit.
- Do not allow debris to fall inside the unit during installation.
- Install at maximum distance from high-voltage cables and power equipment.

Kit Contents

- 1 UIS-08TC module
- 4 I/O terminal blocks (2 black and 2 gray)

UIS-08TC Diagram

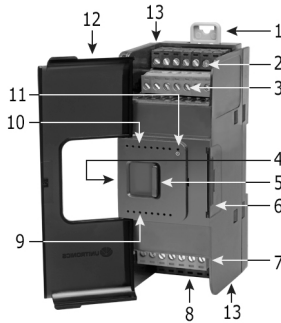

1	DIN-rail clips	Provide physical support for CPU and modules. There are two clips: one at the top (shown), one at the bottom (not shown).
2	Inputs 0-1	Input connection points
3	Inputs 2-3	
4	I/O Bus - Left	Left-side Connector
5	Bus Connector Lock	Slide the Bus Connector Lock to the left, to electrically connect the Uni-I/O™ module to the CPU or adjacent module.
6	I/O Bus - Right Bus Connector Cover	Right-Side Connector, shipped covered. Leave covered when not in use.
7	Inputs 6-7	Input connection points
8	Inputs 4-5	
9	Input LEDs (4-7)	Red LEDs

10	Input LEDs (0-3)	Red LEDs
11	Status LED	Tricolor LED, Green/Red/Orange
NOTE ▪ Refer to the module's specification sheet for LED indications.		
12	Module door	Shipped covered with protective tape to prevent the door from being scratched. Remove tape during installation.
13	Screw holes	Enable panel-mounting; hole diameter: 4mm (0.15").

About the I/O Bus Connectors

The I/O Bus connectors provide the physical and electrical connection points between modules. The connector is shipped covered by a protective cover, protecting the connector from debris, damage, and ESD.

The I/O Bus - Left (#4 in diagram) can be connected to either a CPU-for-Panel, a Uni-COM™ module, to another Uni-I/O™ module or to the End Unit of a Local Expansion Kit.

The I/O Bus - Right (#6 in diagram) can be connected to another I/O module, or to the Base Unit of the Local Expansion Kit.

Caution ▪ If the I/O module is located last in the configuration, and nothing is to be connected to it, do not remove its Bus Connector Cover.

Installation



- Turn off system power before connecting or disconnecting any modules or devices.
- Use proper precautions to prevent Electro-Static Discharge (ESD).

Installing a Uni-I/O™ Module onto a UniStream™ HMI Panel

NOTE The DIN-rail type structure on the back of the panel provides the physical support for the Uni-I/O™ module.

1. Check the unit to which you will connect the Uni-I/O™ module to verify that its Bus Connector is not covered.
If the Uni-I/O™ module is to be the last one in the configuration, do not remove the cover of its I/O Bus Connector - Right.
2. Open the door of the Uni-I/O™ module and hold it as shown in the accompanying figure.
3. Use the upper and lower guide-tunnels (tongue & groove) to slide the Uni-I/O™ module into place.
4. Verify that the DIN-rail clips located at the top and bottom of the Uni-I/O™ module have snapped onto the DIN-rail.

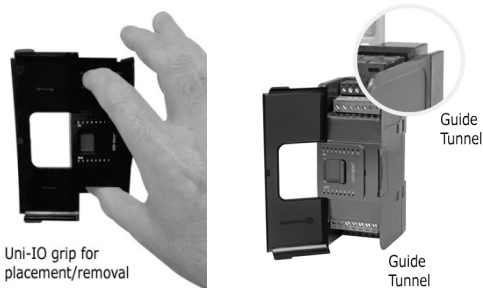

- Slide the Bus Connector Lock all the way to the left as shown in the accompanying figure.
- If there is already a module located to its right, complete the connection by sliding the Bus Connector lock of the adjacent unit to the left.
- If the module is the last in the configuration, leave the I/O bus connector covered.

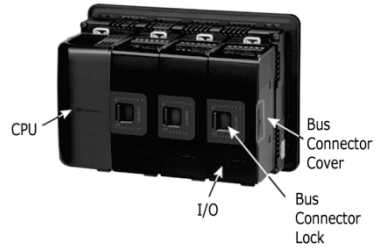

Removing a Module

- Turn off the system power.
- Disconnect the I/O terminals (#2,3,7,8 in the diagram).
- Disconnect the Uni-I/O™ module from the adjacent units: slide its Bus Connector Lock to the right. If there is a unit located on its right, slide the lock of this module to the right as well.
- On the Uni-I/O™ module, pull the top DIN-rail clip up and the bottom clip down.
- Open the door of the Uni-I/O™ and hold it with two fingers as shown in the figure on page 3; then pull it carefully from its place.

Installing Uni-I/O™ modules onto a DIN-rail

To mount modules onto a DIN-rail, follow steps 1-7 in Installing a Uni-I/O™ Module onto a UniStream™ HMI Panel on page 3.

In order to connect the modules to a UniStream™ controller, you must use a Local Expansion Kit.

These kits are available with and without power supplies, and with cables of varying lengths. For complete information, please refer to the installation guide of the relevant Local Expansion Kit.

Numbering Modules

You can number modules for reference purposes. A set of 20 stickers is provided with every CPU-for-Panel; use these stickers to number the modules.



- The set contains numbered and blank stickers as shown in the figure to the left.
- Place them on the modules as shown in the figure to the right.



Wiring



- This equipment is designed to operate only at SELV/PELV/Class 2/Limited Power environments.
- All power supplies in the system must include double insulation. Power supply outputs must be rated as SELV/PELV/Class 2/Limited Power.
- Do not connect either the 'Neutral' or 'Line' signal of the 110/220VAC to device's 0V point.
- Do not touch live wires.



- All wiring activities should be performed while power is OFF.
- Use over-current protection, such as a fuse or circuit breaker, to avoid excessive currents into the UIS-08TC supply port.
- Unused points should not be connected (unless otherwise specified). Ignoring this directive may damage the device.
- Double-check all wiring before turning on the power supply.

Caution

- To avoid damaging the wire, use a maximum torque of 0.5 N·m (5 kgf·cm).
- Do not use tin, solder, or any substance on stripped wire that might cause the wire strand to break.
- Install at maximum distance from high-voltage cables and power equipment.

Wiring Procedure

Use crimp terminals for wiring; use 26-12 AWG wire (0.13 mm 2 –3.31 mm2).

1. Strip the wire to a length of 7 ± 0.5 mm (0.250–0.300 inches).
2. Unscrew the terminal to its widest position before inserting a wire.
3. Insert the wire completely into the terminal to ensure a proper connection.
4. Tighten enough to keep the wire from pulling free.

UIS-08TC Connection Points

All wiring diagrams and instructions in this document refer to the UIS-08TC connection points.

These points are arranged in four groups of seven points as shown in the figure to the right.

Two top groups

Input connection points (0,1,2,3)

Two bottom groups

Input connection points (4,5,6,7) and power supply connection points

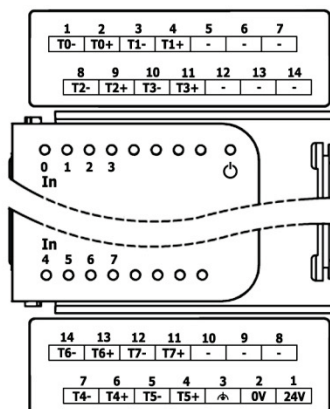
**Wiring Guidelines**

In order to ensure that the device will operate properly and to avoid electromagnetic interference:

- Use a metal cabinet. Make sure the cabinet and its doors are properly earthed.
- Use shielded cables for wiring thermocouple signals and shielded twisted pair cables for wiring analog input voltage signals; do not use the cable shield as a signal common / return path.
- It is recommended to short unused analog inputs (Tx- to Tx+).
- Route each I/O signal with its own dedicated common wire. Connect common wires at their respective common points (Tx-) at the I/O module.
- Individually connect each functional ground point (⚡) to the earth of the system (preferably to the metal cabinet chassis). Use the shortest and thickest wires possible: less than 1m (3.3') in length, minimum thickness 14 AWG (2 mm²).

- Connect the power supply 0V to the earth of the system.
- Earthing the cables' shield:
 - Connect the cable shield to the earth of the system - preferably to the metal cabinet chassis. Note that the shield must be connected only at one end of the cable; typically, earthing the shield at the UIS-08TC end performs better.
 - Keep shield connections as short as possible.
 - Ensure shield continuity when extending shielded cables.

NOTE For detailed information, refer to the document System Wiring Guidelines, located in the Technical Library in the Unitrronics' website.

Wiring the Power Supply

This module requires an external 24VDC power supply.

- In the event of voltage fluctuations or non-conformity to voltage power supply specifications, connect the device to a regulated power supply.

Connect the 24V and 0V terminals as shown in the accompanying figure.

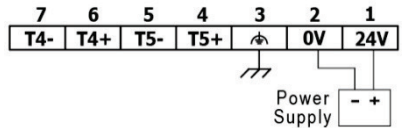

Wiring the Inputs

NOTE ▪ Each input offers two modes: thermocouple or voltage. You can set each input independently. The mode is determined both by wiring and by the hardware configuration within the software application.

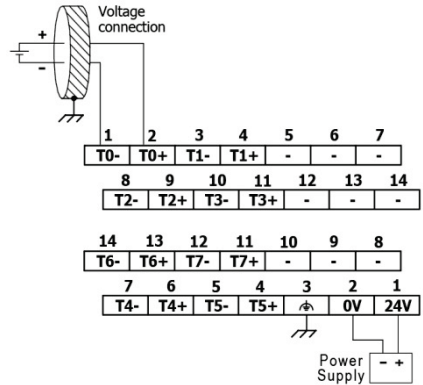
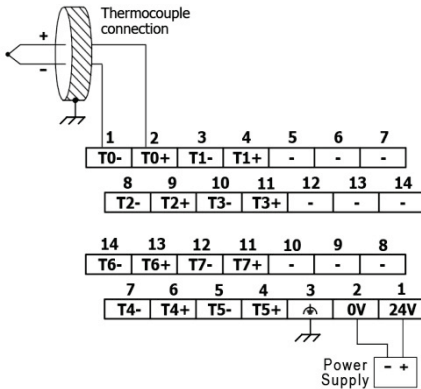

The information in this document reflects products at the date of printing. Unitrronics reserves the right, subject to all applicable laws, at any time, at its sole discretion, and without notice, to discontinue or change the features, designs, materials and other specifications of its products, and to either permanently or temporarily withdraw any of the foregoing from the market.

All information in this document is provided "as is" without warranty of any kind, either expressed or implied, including but not limited to any implied warranties of merchantability, fitness for a particular purpose, or non-infringement. Unitrronics assumes no responsibility for errors or omissions in the information presented in this document. In no event shall Unitrronics be liable for any special, incidental, indirect or consequential damages of any kind, or any damages whatsoever arising out of or in connection with the use or performance of this information.

The tradenames, trademarks, logos and service marks presented in this document, including their design, are the property of Unitrronics (1989) (R'G) Ltd. or other third parties and you are not permitted to use them without the prior written consent of Unitrronics or such third party as may own them.