

Altivar Process

ATV960 High Performance Drive Systems

Handbook

English

10/2017



NHA37115.01

www.schneider-electric.com

Schneider
Electric



Altivar Process

High Performance Drive Systems



From simple solutions → up to individual customizations

The customized solution for your drive

"Ready-to-use" Drive Systems:

- + Developed on highest quality level
- + Manufactured according to your needs
- + Tested at full-load operating conditions
- + Pre-set appropriate to the design

Sophisticated motor control system

- + High overload capability
- + Especially good motor efficiency
- + Impressive robustness against load impacts
- + Excellent performance for all common motor types
- + Significant speed and torque accuracy with and without encoder feedback



- > Asynchronous motors
- > PM motors
- > Torque motors
- > Reluctance motors
- > Special motors like submersible pumps, sliding rotor motors,...

Optimally equipped for safety-relevant applications

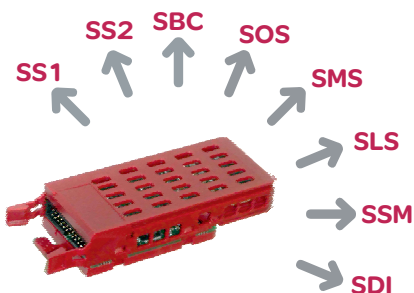

Support of all major safety functions:

- + SS1, SS2 (Safe Stop 1, 2)
- + SBC (Safe Brake Control)
- + SOS (Safe Operating Stop)
- + SMS (Safe Maximum Speed)
- + SLS (Safe Limited Speed)
- + SSM (Safe Speed Monitor)
- + SDI (Safe Direction)



Innovative braking operation by 3-phase design



- + Intelligent monitoring of the braking resistors for overload and wire break
- + Extended life-time of the capacitors
- + Integrated protection against short-circuits and ground faults for the resistor wiring
- + Shielded lines of the optional braking unit for optimal EMC characteristics

Extended connectivity

- + Embedded Dual Ethernet for simple wiring and increased availability
- + Dynamic drive-to-drive communication for multi-motor operation
- + Easy integration thanks to standardized FDT/DTM and ODVA technology
- + Easy access via PC, tablet or smartphone

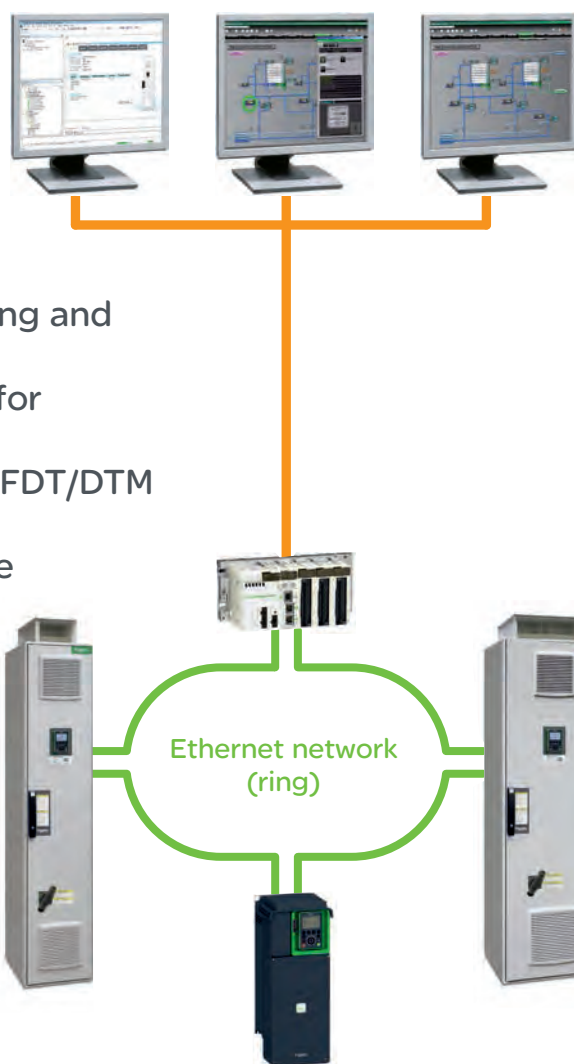

Sophisticated service concept with QR code

- + Modular design allows easy logistics of spare parts
- + Optimized costs of maintenance due to dynamic maintenance schedule with integrated monitoring of the individual components
- + Simple exchange of power modules and fans
- + Quick assistance with dynamic QR codes and Customer Care App



The information provided in this documentation contains general descriptions and/or technical characteristics of the performance of the products contained herein. This documentation is not intended as a substitute for and is not to be used for determining suitability or reliability of these products for specific user applications. It is the duty of any such user or integrator to perform the appropriate and complete risk analysis, evaluation and testing of the products with respect to the relevant specific application or use thereof. Neither Schneider Electric nor any of its affiliates or subsidiaries shall be responsible or liable for misuse of the information contained herein. If you have any suggestions for improvements or amendments or have found errors in this publication, please notify us.

You agree not to reproduce, other than for your own personal, noncommercial use, all or part of this document on any medium whatsoever without permission of Schneider Electric, given in writing. You also agree not to establish any hypertext links to this document or its content. Schneider Electric does not grant any right or license for the personal and noncommercial use of the document or its content, except for a non-exclusive license to consult it on an "as is" basis, at your own risk. All other rights are reserved.

All pertinent state, regional, and local safety regulations must be observed when installing and using this product. For reasons of safety and to help ensure compliance with documented system data, only the manufacturer should perform repairs to components.

When devices are used for applications with technical safety requirements, the relevant instructions must be followed.

Failure to use Schneider Electric software or approved software with our hardware products may result in injury, harm, or improper operating results.

Failure to observe this information can result in injury or equipment damage.

© 2017 Schneider Electric. All rights reserved.

Table of Contents



	Safety Information	7
	About the Book	8
Chapter 1	Drive Systems	11
	Overview	12
	ATV960 – High Performance Drive Systems	13
	Expandability	16
Chapter 2	General Specification	19
	Quality	20
	Mains Conditions	24
	Protection of the Plant	27
Chapter 3	ATV960●●●●4X1	31
	Description	33
	Specification	38
	Circuit Diagram	66
	Mains Connection	67
	Motor Connection	70
	Customizations	77
Chapter 4	Wiring of the Control Terminals	79
	Design/Position of the Individual Terminals	80
	Control Block	81
	Option "Logic and Analog I/O Card"	91
	Option "Relay Output Card"	94
	Option Terminals	95
Chapter 5	Customizations	97
	Enclosure Options	98
	Control Options	102
	I/O Expansion Cards	103
	Communication Cards	104
	Encoder Interface Modules	106
	Functional Safety	107
	Display Options	108
	Motor Options	109
	Mains Supply	111
	Braking Option	115
	Monitoring Options	123
	Packaging	124



Important Information

NOTICE

Read these instructions carefully, and look at the equipment to become familiar with the device before trying to install, operate, or maintain it. The following special messages may appear throughout this documentation or on the equipment to warn of potential hazards or to call attention to information that clarifies or simplifies a procedure.



The addition of this symbol to a "Danger" or "Warning" safety label indicates that an electrical hazard exists which will result in personal injury if the instructions are not followed.



This is the safety alert symbol. It is used to alert you to potential personal injury hazards. Obey all safety messages that follow this symbol to avoid possible injury or death.

DANGER

DANGER indicates a hazardous situation which, if not avoided, **will result in** death or serious injury.

WARNING

WARNING indicates a hazardous situation which, if not avoided, **could result in** death or serious injury.

CAUTION

CAUTION indicates a hazardous situation which, if not avoided, **could result in** minor or moderate injury.

NOTICE

NOTICE is used to address practices not related to physical injury.

PLEASE NOTE

Electrical equipment should be installed, operated, serviced, and maintained only by qualified personnel. No responsibility is assumed to Schneider Electric for any consequences arising out of the use of this material.

A qualified person is one who has skills and knowledge related to the construction and operation of electrical equipment and its installation, and has received safety training to recognize and avoid the hazards involved.

Qualification Of Personnel

Only appropriately trained persons who are familiar with and understand the contents of this manual and all other pertinent product documentation are authorized to work on and with this product. In addition, these persons must have received safety training to recognize and avoid hazards involved. These persons must have sufficient technical training, knowledge and experience and be able to foresee and detect potential hazards that may be caused by using the product, by changing the settings and by the mechanical, electrical and electronic equipment of the entire system in which the product is used. All persons working on and with the product must be fully familiar with all applicable standards, directives, and accident prevention regulations when performing such work.



At a Glance

Document Scope

This document gives you an overview of the available Altivar Process Drive Systems. Furthermore, you can select from the options described in detail in order to adapt the Altivar Process Drive System to the actual requirements of your system.

Validity Note

Original instructions and information given in this manual have been written in English (before optional translation).

This documentation is valid for the Altivar Process Drive Systems.

The technical characteristics of the devices described in this document also appear online. To access this information online:

Step	Action
1	Go to the Schneider Electric home page www.schneider-electric.com .
2	In the Search box type the reference of a product or the name of a product range. <ul style="list-style-type: none">• Do not include blank spaces in the reference or product range.• To get information on grouping similar modules, use asterisks (*).
3	If you entered a reference, go to the Product Datasheets search results and click on the reference that interests you. If you entered the name of a product range, go to the Product Ranges search results and click on the product range that interests you.
4	If more than one reference appears in the Products search results, click on the reference that interests you.
5	Depending on the size of your screen, you may need to scroll down to see the data sheet.
6	To save or print a data sheet as a .pdf file, click Download XXX product datasheet .

The characteristics that are presented in this manual should be the same as those characteristics that appear online. In line with our policy of constant improvement, we may revise content over time to improve clarity and accuracy. If you see a difference between the manual and online information, use the online information as your reference.

Related Documents

Use your tablet or your PC to quickly access detailed and comprehensive information on all our products on www.schneider-electric.com.

The internet site provides the information you need for products and solutions:

- The whole catalog for detailed characteristics and selection guides
- The CAD files to help design your installation, available in over 20 different file formats
- Software and firmware to maintain your drive up to date
- A large quantity of White Papers, Environment documents, Application solutions, Specifications... to gain a better understanding of our electrical systems and equipment or automation
- And finally the User Guides related to your drive, listed below:

Title of Documentation	Reference number
ATV960 Handbook	NHA37114 (German), NHA37115 (English)
Drive Systems – Installation manual	NHA37118 (German), NHA37119 (English), NHA37121 (French), NHA37122 (Spanish), NHA37123 (Italian), NHA37126 (Polish), NHA37127 (Portuguese), NHA37128 (Russian), NHA37129 (Turkish), NHA37130 (Chinese)
ATV9●● Programming manual	NHA80757 (English), NHA80758 (French), NHA80759 (German), NHA80760 (Spanish), NHA80761 (Italian), NHA80762 (Chinese)
ATV9●● Modbus serial link manual (embedded)	NHA80939 (English)
ATV9●● Ethernet manual (embedded)	NHA80940 (English)
ATV9●● PROFIBUS DP manual (VW3A3607)	NHA80941 (English)
ATV9●● DeviceNet manual (VW3A3609)	NHA80942 (English)
ATV9●● PROFINET manual (VW3A3627)	NHA80943 (English)
ATV9●● CANopen serial link manual (VW3A3608, 618, 628)	NHA80945 (English)
ATV9●● EtherCAT manual (VW3A3601)	NHA80946 (English)
ATV9●● Communication parameters	NHA80944 (English)
ATV9●● Safety function manual	NHA80947 (English)
ATV6●● & ATV9●● ATEX manual	NVE42416 (English)
SoMove: FDT	SoMove FDT (English, French, German, Spanish, Italian, Chinese)
Altivar Process ATV9●● DTM	ATV9xx DTM Library EN (English), ATV9xx DTM Library FR (French), ATV9xx DTM Library DE (German), ATV9xx DTM Library SP (Spanish), ATV9xx DTM Library IT (Italian), ATV9xx DTM Library CN (Chinese),

You can download these technical publications and other technical information from our website at www.schneider-electric.com.

Terminology

The technical terms, terminology and the corresponding descriptions in this manual are inspired by the terms or definitions in the relevant standards.

In the area of drive systems this includes, but is not limited to, terms such as **error, error message, failure, fault, fault reset, protection, safe state, safety function, warning, warning message** and so on.

Among others, these standards include:

- IEC 61800 series: Adjustable speed electrical power drive systems
- EN 61439 series: Low-voltage switchgear and controlgear assemblies
- IEC 61508, Ed. 2 series: Functional safety of electrical/electronic/programmable electronic safety-related
- EN 954-1 Safety of machinery – Safety related parts of control systems
- EN ISO 13849-1 and 2 Safety of machinery – Safety related parts of control systems
- IEC 61158 series: Industrial communication networks – Fieldbus specifications
- IEC 61784 series: Industrial communication networks – Profiles
- IEC 60204-1: Safety of machinery – Electrical equipment of machines – Part 1: General requirements

In addition, the term **zone of operation** is used in conjunction with the description of specific hazards, and is defined as it is for a **hazard zone** or **danger zone** in the EC Machinery Directive (2006/42/EC) and in ISO 12100-1.

Contact us

Select your country on:

www.schneider-electric.com/contact

Schneider Electric Industries SAS

Head Office
35, rue Joseph Monier
92500 Rueil-Malmaison
France

Chapter 1

Drive Systems

What Is in This Chapter?

This chapter contains the following topics:

Topic	Page
Overview	12
ATV960 – High Performance Drive Systems	13
Expandability	16

Overview

Market segment	Water and waste water Oil & gas Mining, minerals & metals Food & beverage
-----------------------	--



Drive Systems	Frequency inverter as enclosure unit for speed control of asynchronous and synchronous motors.	
Brief description	Enclosure unit, alternatively in the standard design, with predefined customizations or as individual customer solution	Enclosure unit ready for regeneration, alternatively in the standard design, with predefined customizations or as individual customer solution
Special features	High Performance Drive Systems with high overload capability and sophisticated motor control system	Regenerative Drive Systems with highly efficient 4Q technology for speed control in both energy directions
Protection degree	IP23 standard design of the enclosure IP54 optional design of the enclosure	
Power range	110 / 90 up to 800 / 630 kW	
Voltage ranges	<ul style="list-style-type: none"> ● 3 AC 380 V -10 % ... 415 V +6 % ● 3 AC 400 V -10 % ... 415 V +10 % 	<ul style="list-style-type: none"> ● 3 AC 440 V ±10 % ● 3 AC 480 V ±10 %
Mains frequency	50/60 Hz +/- 5 %	
Output frequency	0.1...500 Hz	
Control method	Asynchronous motor: Constant load torque (open/closed loop), variable load torque (open/closed loop), energy saving Synchronous motor: PM (permanent magnet) motor (open/closed loop)	
Interfaces	Operating panel in the enclosure door, control terminals inside the enclosure, control terminals can be extended, fieldbus connection via Ethernet or Modbus, saving the parameters via USB interface at the keypad	
References	ATV960●●●●●X1	ATV980●●●●●X1
Further reading	You will find detailed information in this document.	You can find detailed information in the "Altivar Process ATV980 Handbook" and on www.schneider-electric.com .

ATV960 – High Performance Drive Systems

High Performance Frequency inverter as enclosure unit for speed control of asynchronous and synchronous motors as well as special motors.



Concept

The concept of the ATV960 High Performance Drive Systems offers standard enclosures ready to connect. The modular construction makes it possible to adapt the enclosure unit to the individual requests. This economic enclosure variant makes the planning easy and supports a quick installation and commissioning of the drive.

Power versus overload

For optimum adaptation to the application you can select between two overload models when dimensioning the Altivar Process Drive System.

- Normal Duty
High continuous power with an overload capability of 20 % (typically compressors, centrifugal pumps and fans)
- Heavy Duty
Reduced continuous power but increased overload capability of 50 % for 60 s; suitable for drives with enhanced requirements regarding overload capability, starting torque, load impacts and control performance (typically mixers, crushers, mills, conveyor belts).

Basic equipment

The basic equipment contains frequency inverter modules, semiconductor fuses, a main switch, a line reactor to reduce the harmonics, a dv/dt filter choke (from 355 kW) for protection of the motor and spacious mains and motor bars for connection of the power cables. The design is based on the standard enclosure system Spacial SF with an graphical operating panel integrated into the enclosure door.

The control is located on a spacious control panel. It provides compact dimensions, nevertheless it is enough space for additional extensions and accessibility in case of maintenance.

Device features

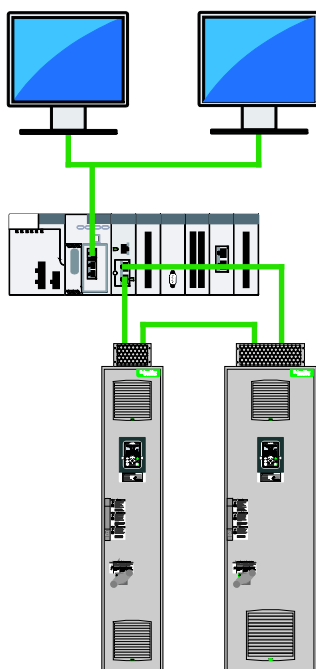

High motor performance

Perfect control over the motor in each operating state due to the new motor control method of the ATV960 High Performance Drive Systems.

- Asynchronous motors (all efficiency classes, high number of poles)
- Synchronous motors (PM motors, torque motors, reluctance motors)
- Special motors for submersible pumps

Extended connectivity

Embedded Dual Ethernet as standard provides increased redundancy and supports RSTP (Rapid Spanning Tree Protocol). Dynamic drive-to-drive communication for multi-motor drives with master/slave groups and perfect load sharing between all motors.

Cooling concept

The power part components are cooled in a separate cooling air channel. Via this channel about 90 % of the heat losses are exhausted. The interior of the enclosure is cooled via fans in the enclosure door.

At enclosure design IP54 the separated air supply for the power part takes place through the enclosure plinth.

Enclosure Design 400 V

ATV960 - General technical data			
Mains voltage	<ul style="list-style-type: none"> ● 3 AC 380 V -10 % ... 415 V +6 % ● 3 AC 400 V -10 % ... 415 V +10 % ● 3 AC 440 V ±10 % ● 3 AC 480 V ±10 % <p>50/60 Hz ±5 % for TT, TN-C or TN-S Other voltages and mains topologies on request.</p>		
Maximum current	<p>Normal duty (ND): 120 % for 60 s per 10 minutes Heavy duty (HD): 150 % for 60 s per 10 minutes</p>		
Ambient temperature	<p>-10...+50 °C (below 0 °C with additional enclosure heating, above +40 °C with derating) You will find further information at chapter "Maximum Ambient Temperature", page 36.</p>		
Standard equipment	<p>Enclosure system Spacial SF in RAL 7035, protection degree IP23, graphical operating panel in the enclosure door, frequency inverter including main switch, line reactor (32...48 % THDi), mains and motor terminals, cable entry from bottom</p>		
Interfaces	<p>Pluggable control terminals, fieldbus connection via Ethernet or Modbus</p>		
Possible customizations	<table style="width: 100%; border: none;"> <tr> <td style="vertical-align: top; width: 50%;"> <ul style="list-style-type: none"> ● Braking unit BUO ● Increased protection degree IP54 ● Enclosure plinth for basic device ● Connection enclosure cable from top/bottom ● Enclosure lighting ● Enclosure heating ● Key switch "local/remote" ● Ethernet port on front door ● Digital and analog I/O card ● Relay output card ● Communication cards for various fieldbus systems ● Encoder interface modules ● STO - SIL 3 Stop category 0 or 1 ● Front display module (FDM) ● Modified wiring colors ● Remote monitoring ● Seaworthy packaging ● Differing mains voltages ● Multipulse supply (12-pulse) ● Design without main switch </td> <td style="vertical-align: top; width: 50%;"> <ul style="list-style-type: none"> ● Increased short-circuit strength (100 kA) ● Indicator lamps on front door ● Motor temperature monitoring ● Bearing temperature monitoring ● dv/dt filter choke ● Motor heating ● Circuit breaker ● Undervoltage coil for circuit breaker 230 V ● Motor for circuit breaker 230 V ● Automated mains disconnect ● Safety labels in local language ● Air intake from back ● Differing enclosure colors ● Customized documentation ● Customized labeling ● Design for IT mains ● Motor contactor ● ... </td> </tr> </table>	<ul style="list-style-type: none"> ● Braking unit BUO ● Increased protection degree IP54 ● Enclosure plinth for basic device ● Connection enclosure cable from top/bottom ● Enclosure lighting ● Enclosure heating ● Key switch "local/remote" ● Ethernet port on front door ● Digital and analog I/O card ● Relay output card ● Communication cards for various fieldbus systems ● Encoder interface modules ● STO - SIL 3 Stop category 0 or 1 ● Front display module (FDM) ● Modified wiring colors ● Remote monitoring ● Seaworthy packaging ● Differing mains voltages ● Multipulse supply (12-pulse) ● Design without main switch 	<ul style="list-style-type: none"> ● Increased short-circuit strength (100 kA) ● Indicator lamps on front door ● Motor temperature monitoring ● Bearing temperature monitoring ● dv/dt filter choke ● Motor heating ● Circuit breaker ● Undervoltage coil for circuit breaker 230 V ● Motor for circuit breaker 230 V ● Automated mains disconnect ● Safety labels in local language ● Air intake from back ● Differing enclosure colors ● Customized documentation ● Customized labeling ● Design for IT mains ● Motor contactor ● ...
<ul style="list-style-type: none"> ● Braking unit BUO ● Increased protection degree IP54 ● Enclosure plinth for basic device ● Connection enclosure cable from top/bottom ● Enclosure lighting ● Enclosure heating ● Key switch "local/remote" ● Ethernet port on front door ● Digital and analog I/O card ● Relay output card ● Communication cards for various fieldbus systems ● Encoder interface modules ● STO - SIL 3 Stop category 0 or 1 ● Front display module (FDM) ● Modified wiring colors ● Remote monitoring ● Seaworthy packaging ● Differing mains voltages ● Multipulse supply (12-pulse) ● Design without main switch 	<ul style="list-style-type: none"> ● Increased short-circuit strength (100 kA) ● Indicator lamps on front door ● Motor temperature monitoring ● Bearing temperature monitoring ● dv/dt filter choke ● Motor heating ● Circuit breaker ● Undervoltage coil for circuit breaker 230 V ● Motor for circuit breaker 230 V ● Automated mains disconnect ● Safety labels in local language ● Air intake from back ● Differing enclosure colors ● Customized documentation ● Customized labeling ● Design for IT mains ● Motor contactor ● ... 		
Standards	<p>CE, EAC, RCM, ATEX, RFI filter for second "industrial environment" C3 integrated</p>		

Type	Size	Motor rating (ND / HD)	Output current (ND / HD)	Dimensions		
				Width	Depth ⁽¹⁾	Height
ATV960C11●4X1	1p	110 kW / 90 kW	211 A / 173 A	400 mm	600 mm	2150 mm
ATV960C13●4X1		132 kW / 110 kW	250 A / 211 A	400 mm	600 mm	2150 mm
ATV960C16●4X1		160 kW / 132 kW	302 A / 250 A	400 mm	600 mm	2150 mm
ATV960C20●4X1	2p	200 kW / 160 kW	370 A / 302 A	600 mm	600 mm	2150 mm
ATV960C25●4X1		250 kW / 200 kW	477 A / 370 A	600 mm	600 mm	2150 mm
ATV960C31●4X1		315 kW / 250 kW	590 A / 477 A	600 mm	600 mm	2150 mm
ATV960C35●4X1	3p	355 kW / 280 kW	660 A / 520 A	800 mm	600 mm	2150 mm
ATV960C40●4X1		400 kW / 315 kW	730 A / 590 A	800 mm	600 mm	2150 mm
ATV960C45●4X1		450 kW / 355 kW	830 A / 660 A	800 mm	600 mm	2150 mm
ATV960C50●4X1		500 kW / 400 kW	900 A / 730 A	800 mm	600 mm	2150 mm
ATV960C56●4X1	4p	560 kW / 450 kW	1020 A / 830 A	1200 mm	600 mm	2150 mm
ATV960C63●4X1		630 kW / 500 kW	1140 A / 900 A	1200 mm	600 mm	2150 mm
ATV960C71●4X1	5p	710 kW / 560 kW	1260 A / 1020 A	1400 mm	600 mm	2150 mm
ATV960C80●4X1		800 kW / 630 kW	1420 A / 1140 A	1400 mm	600 mm	2150 mm
(1) Total depth including door handle and switch handle: 664 mm						

Expandability

The new Altivar Process Drive Systems are the result of our many years of experience in the field of electronic drives. Moreover we provide especially designed expansion options for a various range of applications. Our worldwide, certified manufacturing sites and the local engineering teams allow a global offer.

Predefined Customizations



Due to the predefined customizations the Altivar Process Drive System can be adapted easily and quick to the customer requirements. Besides, this allows minimal delivery time for an individually adapted enclosure ready to connect.

Certainly the Altivar Process Drive Systems can be ordered also in the basic design, which is already extensive equipped, without any customization.

Predefined customizations are:

- Braking unit BUO
- Increased protection degree IP54
- Enclosure plinth for basic device
- Connection enclosure cable from top/bottom
- Enclosure lighting
- Enclosure heating
- Key switch "local/remote"
- Ethernet port on front door
- Digital and analog I/O card
- Relay output card
- Communication cards for various fieldbus systems
- Encoder interface modules
- STO - SIL 3 Stop category 0 or 1
- Front display module (FDM)
- Indicator lamps on front door
- Motor temperature monitoring
- Bearing temperature monitoring
- dv/dt filter choke
- Motor heating
- Circuit breaker
- Undervoltage coil for circuit breaker
- Motor for circuit breaker
- Automated mains disconnect
- Safety labels in local language
- Modified wiring colors
- Remote monitoring
- Seaworthy packaging
- Differing mains voltages
- Multipulse supply (12-pulse)
- Design without main switch
- Increased short-circuit strength (100 kA)
- Air intake from back
- Differing enclosure colors
- Customized documentation
- Customized labeling
- Design for IT mains
- Motor contactor
- Integrated control functions
- ...

Individual Customizations



Due to our substantial know-how and the high flexibility in performing projects, it is possible to realize unique system solutions. They are individually adapted to the customers demands.

Typical customizations:

- Multi drives (several frequency inverters in an enclosure composition)
- Differing cooling system
- Different enclosure system
- Differing dimensions
- ...

Type designation

The type designation of the Altivar Process Drive Systems consists of several points of signs (characters and figures). The meaning of each point is illustrated in the following example.

		ATV	960	C16	Q4	X1
Product	Description					
ATV	Altivar					
Segments						
960	High Performance Drive Systems					
Drive power						
C11...C80	110 / 90 kW ... 800 / 630 kW					
Mains voltage						
Q4	3 AC 380 V -10 %...415 V +6 % (+10 %)					
R4	3 AC 440 V ±10 %					
T4	3 AC 480 V ±10 %					
Design variant						
X1	Europe CE					

Chapter 2

General Specification

What Is in This Chapter?

This chapter contains the following topics:

Topic	Page
Quality	20
Mains Conditions	24
Protection of the Plant	27

Quality

Altivar frequency inverters use modern components and solutions for the control of asynchronous three-phase motors and synchronous three-phase motors. This enables an extremely compact design and user-friendly device features.

Our high degree of quality awareness ranges from the basic requests in the product specification over the development of the cooling system, of the mechanical design, of the electrical circuit diagram and the individual functions up to the production of the device. This process quality level is also long-term guaranteed by means of the corresponding quality assurance systems in the individual business processes and is certified every year by independent authorities according to DIN EN ISO 9001.

The Altivar Process Drive Systems fulfil the relevant international standards and regulations.

System concept ATV960

Altivar Process Drive Systems are manufactured according to the selected design (basic device and options) and are delivered as a drive unit ready to connect. They include the functionally necessary components.

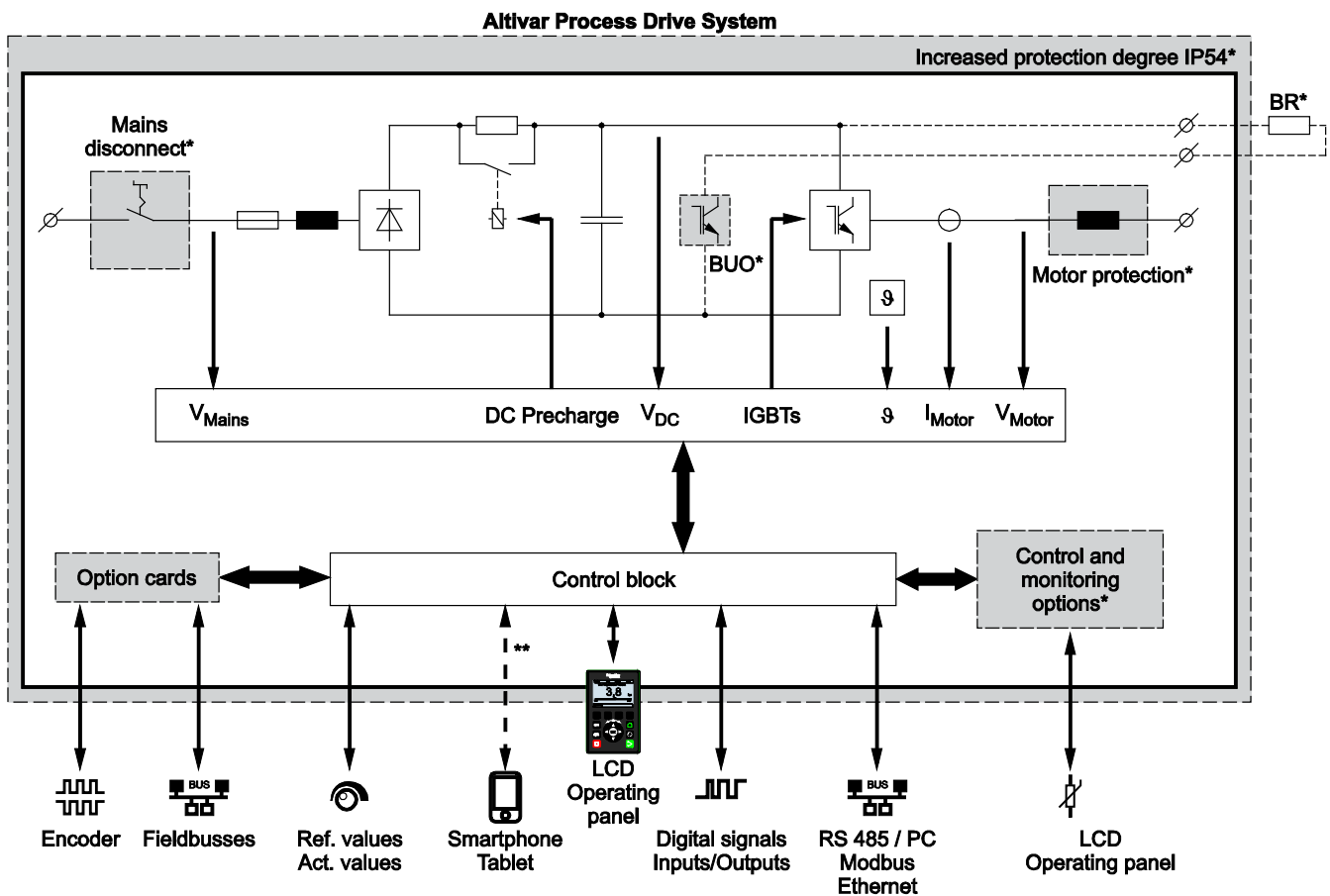

* Optionally selectable

** With optional WIFI module (TCSEGWB13FA0)

Depending on the local conditions and the requests on the drive the basic design can be supplemented by options. Options for the power path, options for control and operation as well as mechanical options are available. They are all integrated into the enclosure unit but they may cause a change of dimensions.

CE Marking

The frequency inverters have a CE marking on the rating plate. However, to achieve the corresponding limits it is necessary to observe the installation regulations, superior and regional standards and directives as well as the directives listed below.

All devices and drives of the electric drive engineering may cause electromagnetic interferences and otherwise they may be influenced by such interferences. Therefore, they are subject to the **EMC directive 2004/108/EC**.

The frequency inverters have an operating voltage which is clearly in the range of 50...1000 V AC or 75...1500 V DC. Therefore, they are also subject to the **Low Voltage Directive 2006/95/EC**.

Because of the EMC filters which are built into the frequency inverters they are in conformity with **EN 61800-3** and **EN 61800-5-1**.

Frequency inverters are not considered as stand-alone machines according to the Machinery Directive 2006/42/EC. They have to be accounted as component of the closed functional safety system.

This product meets the EMC requirements according to the standard IEC 61800-3 if the measures described in this manual are implemented during installation.

If the selected composition (product itself, mains filter, other accessories and measures) does not meet the requirements of category C1, the following information applies as it appears in IEC 61800-3:

⚠ WARNING
RADIO INTERFERENCE
In a domestic environment this product may cause radio interference in which case supplementary mitigation measures may be required.
Failure to follow these instructions can result in death, serious injury, or equipment damage.

Installation Regulations

- The frequency inverters have a RFI filter for grounded mains built-in.
- Take care of good HF connection between motor cable screen and filter.
- Use of shielded motor cables, proper connection of the motor cables on both ends or proper laying in a metallic, closed and interconnected cable conduit
- In case of high motor cable lengths a corresponding dv/dt filter choke is required.
- Use shielded control cables and connect them correctly.
- Ground the frequency inverter for human protection.
- Consider the protective separation (PELV) when preparing signal wires and coupling relays.
- Lay the motor cables separate from other cables, especially from the signal wires.

NOTE: Further information is given in the installation manual.

Safety of Machinery

For the functional safety and stop categories the function "Safe Torque Off (STO)" has been integrated. So an optimal adaptation of the drive to the required safety category for the machine is possible.

NOTE: You will find further information about this function in chapter "Safe Torque Off (STO)", page 107.

For all selectable safety options the implementation of external safety-relevant contacts is provided. So the Altivar Process does not act as a closed functional safety system in terms of the Machine directive and safety standards EN/IEC 61508, ISO 13849-1 and NF EN 62061. It has to be accounted as component in any case.

EMC Product Standard for PDS (Power Drive Systems) EN 61800-3

For frequency inverter drives the product standard EN/IEC 61800-3 edition 1 and 2 appeared. It has first priority over the existing general standards (generic standards). If a drive is installed into another device for which a separate EMC product standard exists, then this standard applies.

The aim of the **EMC directive 2004/108/EEC** is the ability of electric and electronic installations to operate satisfactorily in their electromagnetic environment without influencing the environment or other loads therein.

Therefore, the PDS product standard contains both limits for admissible interferences and requirements for the necessary interference resistance.

The power drive standard EN 61800-3 covers the complete drive from the mains supply to the motor shaft.

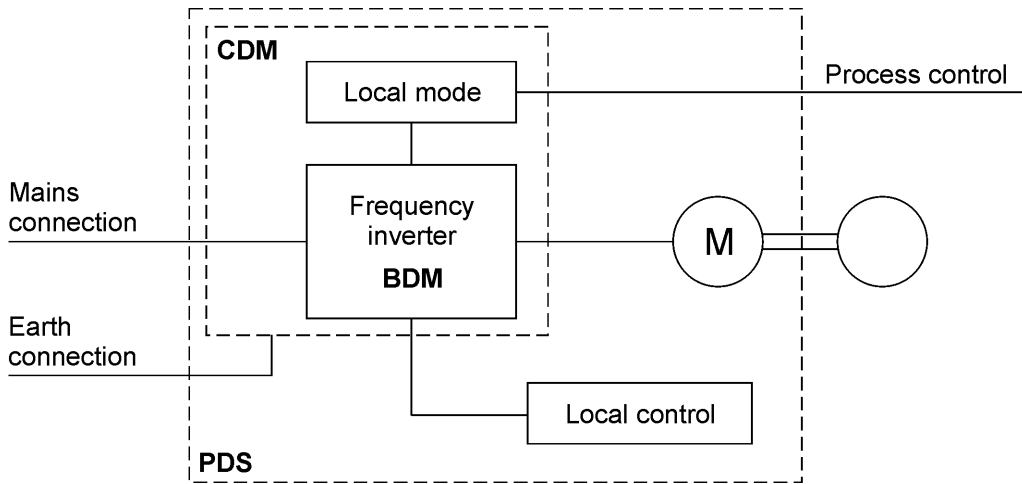

- BDM: Base-Drive-Module Basic drive consisting of the power part and the control electronics (e.g. frequency inverter - built-in unit)
- CDM: Complete-Drive-Module Drive modules consisting of BDM (basic drive) and extensions, if existing (e.g. enclosure including main switch, circuit breaker, line contactor, filter components, power terminals, ...)
- PDS: Power-Drive-System Drive system consisting of CDM (drive module) and motor, motor cable, local control, power transformer, ... (e.g. the complete electric drive of a machine)

The differentiation in respect of the sales method and the range of use is essential for the handling of frequency inverters.

Use In Industrial Environment

The standard refers to these application areas as "second environment". These are areas which are separated from the public mains by means of an own transformer.

The user has to take care that the suppression components recommended by the manufacturer are used and that the introductions of the manufacturer are observed. Moreover, the user has to take care that strong interferences do not couple into neighboring low-voltage mains.

If the neighboring mains is a public mains with residential areas, the limits 66-56/56/60 dB(μV) quasi-peak apply. In case of industrial mains the higher limits 79/73/73 dB(μV) quasi-peak can be used.

Furthermore, it is necessary to enhance the suppression of interferences if other devices are influenced. The operator of the plant is responsible for this improvement.

The limits for immunity are much stricter because they are based on a generally higher level of interferences.

Category C3

Use in industrial environments

Limits for interferences	Line-conducted interferences	Radiation
For drives with a size ≤ 100 A the admissible limits for interferences are 100/86/90-70 dB(μV) quasi-peak and 50/60 dB(μV/m) at a distance of 10 m (class A group 2).	<p>dBμV (QP)</p> <p>0.15 0.5 5 30 MHz</p>	<p>dBμV/m (QP)</p> <p>30 230 1000 MHz</p>
For drives with a size > 100 A the admissible limits for interferences are 130/125/115 dB(μV) quasi-peak and 50/60 dB(μV/m) at a distance of 10 m (class A group 2).	<p>dBμV (QP)</p> <p>0.15 0.5 5 30 MHz</p>	<p>dBμV/m (QP)</p> <p>30 230 1000 MHz</p>

Category C4

Use in industrial environments for drives > 1000 V or > 400 A

For these drives are no limits defined. An EMC concept has to be compiled within project planning.

IT mains

In case of non-grounded mains it is usually not possible to keep the limits. Filter capacitors make detection of insulation faults difficult and thus they interfere with the concept of a floating power supply. However, filters that are developed especially for IT mains can be used because they also cause a high reduction of the conducted interferences in non-grounded mains.

NOTE: The basic requirements for compliance with the relevant limits are the observance and compliance of the installation requirements and a correct customization of the Drive System.

Mains Conditions

Mains Voltage

The Altivar Process Drive Systems are designed for standard industrial mains TT and TN with following mains voltage:

- 3 AC 380 V -10 % ... 415 V +6 %
- 3 AC 400 V -10 % ... 415 V +10 %
- 3 AC 440 V ±10 %
- 3 AC 480 V ±10 %

NOTE: Other voltages and the use in IT mains or "Corner grounded networks" are available on request.

The mains voltage must comply with the requirements according to IEC 60038 and EN 50160:

- Unbalance between phases: < 2 %
- Total harmonic factor THD(v): < 10 %
- Maximum single harmonic: < 5 %

NOTICE

DESTRUCTION DUE TO INCORRECT MAINS VOLTAGE

Before switching on and configuring the product, verify that it is approved for the mains voltage.
Failure to follow these instructions can result in equipment damage.

Undervoltage behavior

In case of short-time mains voltage drops outside the specified tolerance, operation is still possible.

If the mains voltage does not return within the specified time, an undervoltage shut-down occurs.

Mains undervoltage	Restriction
-10 % of nominal voltage	Starting the drive and continuous operation possible ⁽¹⁾
-15 % of nominal voltage	Starting the drive and operation ⁽¹⁾ for 10 s per 100 s possible
-20 % of nominal voltage	Operation ⁽¹⁾ for less than 1 s possible
-30 % of nominal voltage	Operation ⁽¹⁾ for less than 0.5 s possible
(1) With nominal current	

Non-grounded Mains

The Altivar Process Drive Systems can be prepared for the use in non-grounded mains (IT mains or "Corner grounded networks").

Radio Interferences

The Altivar Process Drive Systems include a radio frequency interference filter as standard. This filter fulfils the requirements for category "C3 – industrial environments" according to EN/IEC 61800-3 (in the past: EN 55011 class A group 2).

This product meets the EMC requirements according to the standard IEC 61800-3 if the measures described in this manual are implemented during installation.

If the selected composition (product itself, mains filter, other accessories and measures) does not meet the requirements of category C1, the following information applies as it appears in IEC 61800-3:

WARNING

RADIO INTERFERENCE

In a domestic environment this product may cause radio interference in which case supplementary mitigation measures may be required.

Failure to follow these instructions can result in death, serious injury, or equipment damage.

Mains Impedance / Short-circuit Current

The Altivar Process Drive Systems are designed considering a maximal and minimal permitted mains short-circuit current of the supply (values see "Technical data" of the respective frequency inverter).

These frequency inverters can be designed for higher mains short-circuit currents on request. You will find information about the short-circuit protection at chapter "Mains Connection", page 67.

Reactive Current Compensation Systems

Frequency inverters cause harmonics in the supplying mains (see chapter "Mains Current Harmonics / Mains Voltage Distortion", page 69). If a reactive current compensation system is used upstream of the drive, the harmonics can cause overload of the capacitors of the reactive current compensation system.

Switched reactive current compensation systems can cause overvoltage in the mains supply. Such overvoltages can adversely affect the frequency inverter.

NOTICE

MAINS OVERVOLTAGE AND OVERLOAD OF THE REACTIVE CURRENT COMPENSATION SYSTEM

Install properly rated chokes upstream of the reactive current compensation system.

Failure to follow these instructions can result in equipment damage.

12-/24-pulse Supply

All Altivar Process Drive Systems can be designed with 12-pulse supply. For some types also the design with 24-pulse supply is possible.

NOTE: You will find information about the design variations from page 113.

Switching Rate

Altivar Process Drive Systems are equipped with a main switch for disconnecting the applied mains voltage.

In case of frequent start/stop requests it is recommended to realize them by means of the digital control inputs (or via a serial bus) directly to the electronics of the inverter.

Optionally the mains separation can be realized by a circuit breaker with motor.

NOTE: By means of the certificated control inputs $\overline{\text{STOA}}$ and $\overline{\text{STOB}}$ a "Safe Torque Off" of the drive is considering the safety category according to ISO 13849-1 (and IEC/EN 61800-5-2). Disconnecting the mains supply or the motor is therefore not required.

Inverter control	Switching rate ATV960
Mains voltage switched external	Max. 60 switching operations per hour
Mains voltage switched internal: <ul style="list-style-type: none"> ● Main switch (standard) ● Circuit breaker (option) ● Circuit breaker with motor (option) 	Max. 10 switching operations per hour Max. 10,000 switching operations total
Start / Stop requests via digital inputs with active energy saving function "Stop and Go" ⁽¹⁾	Max. 60 switching operations per hour
Start / Stop requests via digital inputs without energy saving function "Stop and Go" ⁽¹⁾	Arbitrary
Release / Lock via STO inputs with active energy saving function "Stop and Go" ⁽¹⁾	Max. 60 switching operations per hour
Release / Lock via STO inputs without energy saving function "Stop and Go" ⁽¹⁾	Arbitrary
Mains voltage switched external via contactor (on request)	Max. 60 switching operations per hour
(1) The energy saving function "Stop and Go" is activated by default.	

NOTE: The device fans are automatically controlled depending on the start/stop request.

If the power stage is disabled unintentionally, for example, as a result of power outage, errors or functions, there is a possibility that the motor is no longer decelerated in a controlled way.

⚠ WARNING
UNANTICIPATED EQUIPMENT OPERATION
Verify that movements without braking effect does not result in unsafe conditions.
Failure to follow these instructions can result in death, serious injury, or equipment damage.

Protection of the Plant

Responsibility

All stated connection recommendations and planning remarks are to be taken merely as suggestions which must be adapted to the local conditions and regulations concerning installation and usage.

This applies especially to the functional safety regulations for machines, the EMC regulations and the general regulations for human protection.

Installation Site

Altivar Process Drive Systems are qualified for vertical installation in electrical operating rooms as well as in the area of production facilities.

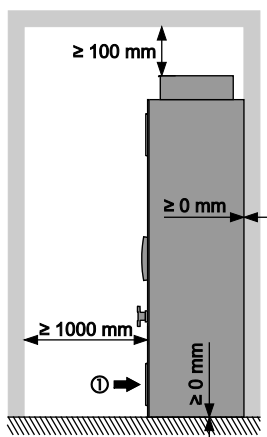

- Observe the specified minimum distances. Mounting the Drive Systems side by side or back to back is allowed.
- Install the Altivar Process Drive System vertically on a non-combustible, solid and vibration-free ground.
- Take care of compliance with the ambient conditions.
- Take care that the air exchange is sufficient for dissipation of the lost heat during operation.

- ① Air inflow temperature: -10...+50 °C (14...122 °F)
(below 0 °C (32 °F) with additional enclosure heating,
above +40 °C (104 °F) with derating)

NOTE: At enclosure design IP54 the ATV960 frequency inverter is qualified for pollution degree 3 according to EN 61800-5-1.

NOTE: Further information is given in the installation manual.

This equipment has been designed to operate outside of any hazardous location. Only install this equipment in zones known to be free of hazardous atmosphere.

⚠ DANGER

POTENTIAL FOR EXPLOSION

Install and use this equipment in non-hazardous locations only.

Failure to follow these instructions will result in death or serious injury.

Increased Motor Speed

With the Altivar Process Drive Systems it is possible to control the rotational speed of motors from 0.1...500 Hz.

Overvoltage Protective Circuit

The AC and DC control circuits must be protected against overvoltage.

Use flyback diodes for DC control circuits.

For AC control circuits, RC circuits are advisable because they can reduce the peak overvoltage and the rise time while varistors only reduce the peak voltage.

NOTICE
INOPERATIVE CONTROL CIRCUITS Verify that all inductances such as relays, contactors, external brakes, etc. are equipped with appropriate overvoltage protection circuits. Failure to follow these instructions can result in equipment damage.

Residual Current Circuit Breaker

Frequency inverters, especially those with additional EMC filters and shielded motor cables, lead an increased leakage current against ground.

The leakage current depends on:

- The length of the motor cable
- The type of laying and whether the motor cable is shielded or not
- The set pulse frequency
- The use of an additional radio frequency interference filter
- The grounding of the motor at its installation place (grounded or non-grounded)

Depending on the conditions, the leakage current of plants with high cable lengths can be absolutely higher than 100 mA !

The built-in residual current detection has no current-limiting effect. It only helps to protect the drive and is no human protection.

Particularly because of the capacitors of the radio frequency interference filter, an unintentional triggering of a residual current circuit breaker may occur at the moment of switching on. As well, the ground capacitances may cause an incorrect triggering during operation. On the other hand, it is possible that the triggering is blocked by means of DC components which are caused by the mains rectification at the input of the inverter.

Direct current can be introduced in the protective ground conductor of this drive. If a residual current device (RCD / GFCI) or a residual current monitor (RCM) is used for additional protection against direct or indirect contact, the following specific types must be used:

 WARNING
DIRECT CURRENT CAN BE INTRODUCED INTO THE PROTECTIVE GROUND CONDUCTOR Use a Type B Residual Current Device (RCD / GFCI) or a Residual Current Monitor (RCM) that has approval for use with frequency inverters and is sensitive to all types of current. Failure to follow these instructions can result in death, serious injury, or equipment damage.

Further conditions for use of a residual current device:

- The drive has an increased leakage current at the moment power is applied. Use a residual current device (RCD / GFCI) or a residual current monitor (RCM) with a response delay.
- High-frequency currents must be filtered.

NOTE: Protect the other loads by means of a separate residual current circuit breaker.

Automatic Restarting

This function increases the availability, especially for drives that are not integrated into the plant control via a fieldbus system. Depending on the parameterization, the frequency inverter can automatically start-up again after each mains switch-on or mains recurrence.

Locking of the Frequency Inverter

Altivar Process Drive Systems include the standard protective function "Safe Torque Off (STO)", which helps to prevent any unintended start-up of the motor. This function fulfills, when correctly wired, the machine standard ISO 13849-1 Performance level PL e, the IEC/EN 61508 Safety integrity level SIL 3 standard for functional safety and the power drive system standard IEC/EN 61800-5-2.

NOTE: You will find further information in the Safety Function Manual ([NHA80947](#)).

The safety function STO (Safe Torque Off) does not remove power from the DC bus. The safety function STO only removes power to the motor. The DC bus voltage and the mains voltage to the drive are still present.

DANGER

HAZARD OF ELECTRIC SHOCK

- Do not use the safety function STO for any other purposes than its intended function.
- Use an appropriate switch, that is not part of the circuit of the safety function STO, to disconnect the drive from the mains power.

Failure to follow these instructions will result in death or serious injury.

When the safety function STO is triggered, the power stage is immediately disabled. In the case of vertical applications or external forces acting on the motor shaft, you may have to take additional measures to bring the motor to a standstill and to keep it at a standstill when the safety function STO is used, for example, by using a service brake.

WARNING

INSUFFICIENT DECELERATION OR UNINTENDED EQUIPMENT OPERATION

- Verify that using the safety function STO does not result in unsafe conditions.
- If standstill is required in your application, ensure that the motor comes to a secure standstill when the safety function STO is used.

Failure to follow these instructions can result in death, serious injury, or equipment damage.

Stop and Go Function



All Altivar Process Drive Systems include the energy saving function "Stop and Go". When the frequency inverter gets a stop or lock request, the own consumption is clearly decreased by reducing the DC link voltage. With the next start request the DC link is charged and the motor can start-up again.

NOTE: For applications where a start delay of 1...2 s is undesired, this energy saving function can be also deactivated.

Connecting and Disconnecting the Motor

Alternatively to the use of the control terminal STO "Safe Torque Off" a safety switch or a motor contactor can be installed to connect and disconnect the motor – Design on request.

After connection the motor restarts by means of the function "Catch on the fly".

Multi-motor Operation

With Altivar Process Drive Systems it is possible to operate several motors at one output.

For multi-motor applications (e.g. roller conveyors), however, observe the following:

- The sum of the nominal currents has to be less than the nominal current of the inverter.
- A different speed control is not possible.
- The total motor cable length has to be taken into consideration.
- No high starting torque is available.
- The inverter does not provide individual motor overload protection.
- Autotuning is not possible (but also not necessary).
- Activation of individual motors is only permitted when the starting current remains less than the maximum inverter current.

Operation of ATEX Motors

If you want to operate an explosion-protected motor (ATEX) with this drive system, you must use the option "Motor monitoring PTC with ATEX certificate".

NOTE: You will find further information about the operation of ATEX motors in the ATEX manual ([NVE42416](#)).

This equipment has been designed to operate outside of any hazardous location. Only install this equipment in zones known to be free of hazardous atmosphere.

DANGER

POTENTIAL FOR EXPLOSION

Install and use this equipment in non-hazardous locations only.

Failure to follow these instructions will result in death or serious injury.

Chapter 3

ATV960●●●●4X1

What Is in This Chapter?

This chapter contains the following topics:

Topic	Page
Description	33
Specification	38
Circuit Diagram	66
Mains Connection	67
Motor Connection	70
Customizations	77

Description

ATV960 High Performance Drive Systems in Enclosure Design for 400 V Mains

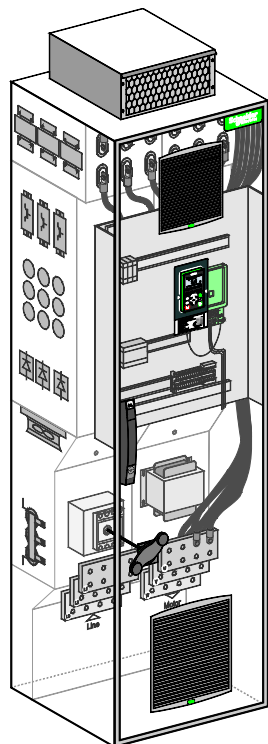

Power components:

- Mains connection terminals
- Main switch
- Semiconductor fuses
- EMC filter
- Line reactor(s)
- Rectifier module(s)
- Inverter module(s)
- dv/dt filter choke(s) (optional at size 1p and 2p)
- Terminals for motor connection

Design:

- Floor-standing enclosure
- Integrated control panel
- Protection degree IP23
- Forced cooling
- -10...+50 °C
(below 0 °C with additional enclosure heating,
above +40 °C with derating)
- Graphical operating panel in the enclosure door

Scope of delivery:

- ATV960 High Performance Drive System
- Multilingual instructions
- Documentation-CD-ROM with parameterization instructions, fieldbus instructions, operating and parameterizing software, ...
- Enclosure layout plans consisting of circuit diagram, terminal connection table, list of materials and design drawing
- Transport packaging

General Technical Data

Input	
Rated voltage U_n	for TT, TN-C or TN-S: <ul style="list-style-type: none"> ● 3 AC 380 V -10 % ... 415 V +6 % ● 3 AC 400 V -10 % ... 415 V +10 % ● 3 AC 440 V \pm10 % ● 3 AC 480 V \pm10 % Other voltages and mains topologies on request.
Rated frequency f_n	50 / 60 Hz \pm 5 %
Overvoltage category	Category III according to EN 50178
Output	
Control method	Asynchronous motor: Constant load torque (open/closed loop), variable load torque (open/closed loop), energy saving Synchronous motor: PM (permanent magnet) motor (open/closed loop)
Voltage	3 AC 0...100 % mains voltage
Overload	Normal Duty (ND): 120 % for 60 s per 10 minutes Heavy Duty (HD): 150 % for 60 s per 10 minutes
Pulse frequency	2.5 kHz, adjustable from 2...8 kHz
Frequency	0.1...500 Hz
Short-circuit protection	Short-circuits and ground faults are handled by overcurrent function and switch-off the output.
Speed accuracy	V/f mode: slip frequency VC without feedback: 0.3 x slip frequency
Mechanical strength	
Mechanical vibrations	According to IEC/EN 60068-2-6 1.5 mm at 3...10 Hz, 0.6 g at 10...200 Hz (3M3 according to IEC/EN 60721-3-3)
Mechanical shock	According to IEC/EN 60068-2-27 4 g for 11 ms (3M2 according to IEC/EN 60721-3-3)
Ambient conditions	
Ambient temperature	-10...+50 °C (below 0 °C with additional enclosure heating, above +40 °C with derating) 3K3 according to IEC/EN 60721-3-3
Storage / Transport temperature	-25...+70 °C
Protection degree	Door closed: IP23 (optionally enclosure design IP54) Door open: IP2x
Environmental class / Humidity	Class 3K3 in accordance with IEC/EN 60721-3-3 / no condensation inside the enclosure, max. 95 % relative humidity
Altitude	Up to 1000 m no derating necessary 1000...2000 m derating of 1 % / 100 m (for all types of mains) 2000...3800 m derating of 1 % / 100 m (only TT/TN, IT) 3800...4800 m derating of 1 % / 100 m (only TT/TN)
Allowed pollution	Pollution degree IP23: 2 according to EN 61800-5-1 Pollution degree IP54 (optional): 3 according to EN 61800-5-1 Chemical / mechanical classification: 3C3 and 3S3 according to EN 60721-3-3
Protection class	Class 1 according to EN 61800-5-1

Functional safety	
Functional safety of the drive	The function "Safe Torque Off" (STO) allows a controlled shut-down and switch-off of the power supply to the motor. It also helps to prevent any unintended start of the motor according to ISO 13849-1, performance level PL e, according to IEC/EN 61508 safety integrity level SIL 3 and IEC/EN 61800-5-2.
Response time	≤ 100 ms at STO (Safe Torque Off)
Standards	
Basic standard	The devices are designed, built and tested on the basis of EN 61800-2, EN 61800-3, EN 61800-5-1 and EN 60204-1.
EMC immunity	According to EN 61800-3, second environment (EN 61000-4-2; EN 61000-4-3; EN 61000-4-4; EN 61000-4-5; EN 61000-4-6)
EMC emission	In accordance with product standard EN 61800-3, second environment, category C3
Insulation	Galvanic insulation of the control circuit in accordance with EN 61800-5-1 PELV (Protective Extra Low Voltage)
Standards	CE, EAC, RCM, ATEX, EN 61800, RFI filter for second "industrial environment" C3 integrated

Protection Degree

The standard design of the Altivar Process Drive Systems complies with protection degree IP23. It provides optimal cooling of the built-in frequency inverter modules and all power components as well as maximum compactness at the same time.

Standard enclosure design IP23	
	<p>For optimized cooling of the Altivar Process Drive System, all power part components are arranged in the main cooling air channel.</p> <p>The input of the cooling air takes place by a grid in the lower area of the enclosure door.</p> <p>The internal fan, which is in a separated air channel, provides the cooling of the power part. The air outlet takes place through the top of the enclosure.</p> <p>The heat losses of the control part are exhausted by a fan in the enclosure door.</p> <ol style="list-style-type: none"> 1 Air inflow grid (without filter mat) for control part and power part 2 Line reactor 3 Fans for power part 4 Rectifier module 5 Inverter module 6 dv/dt filter choke (from 355 kW built-in as standard) 7 Air outlet through metal grid with splash water protection 8 Air outlet (without filter mat) with fans for control part <p>Air inflow temperature: -10...+50 °C (below 0 °C with additional enclosure heating, above +40 °C with derating)</p>

NOTE: For details about the increased protection degree IP54 see chapter "Increased Protection Degree IP54", page 98.

Cooling concept

Control/monitoring of fans

The power part fans as well as the fans in the enclosure door are controlled energy optimized depending on the operation. Switching the fans on and off is derived from the start/stop request.

The fans in the power part are equipped with speed monitoring and the fans in the enclosure doors include a temperature monitoring and that helps to protect the Altivar Process Drive Systems. If one of these monitoring units triggers, a warning message is generated.

Furthermore, the operating hours of all fans can be monitored and a warning message can be triggered when the set limit is exceeded.

Overtemperature protection

The temperature of the power part is monitored all the time. In case of overtemperature the pulse frequency or the power is automatically reduced.

The temperature of the control part is monitored with a thermostat. When the set temperature is exceeded, a warning message is generated. Only in case of insufficient cooling the drive is necessarily shut down.

Maximum Ambient Temperature

Depending on the chosen pulse frequency, the maximum ambient temperature and the desired output frequency a derating is necessary. This can be determined by means of the following diagrams.

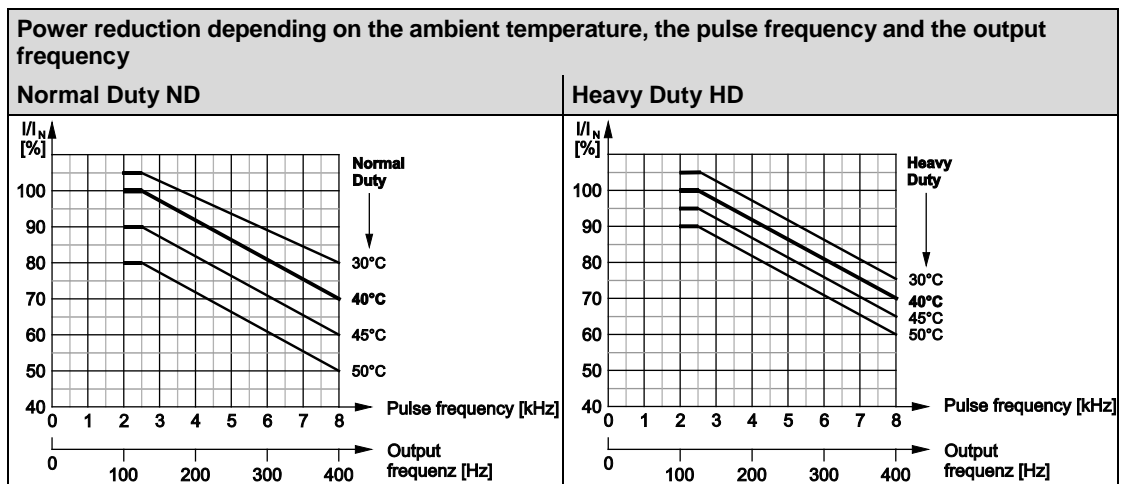

Observe the following guidelines:

- In case of output frequencies higher than 125 Hz the pulse frequency is increased automatically. So the pulse frequency is increased to 4 kHz at 200 Hz output frequency, for example. Consequently, a derating of 8 % at max. 40°C has to be considered.
- Due to the reduction of the output current also the overload capability of the Altivar Process Drive System is reduced.
- At higher pulse frequencies the allowed motor cable length is reduced (see page 72).
- For full shaft power the motor size should not be more than one power rating bigger than the drive.

NOTE: If the ambient temperature is too high, the pulse frequency is automatically reduced which helps to prevent an overload of the inverter (except in case of operation with sinus-motor-filter).

Continuous Current and Overload at < 2 Hz

In order to avoid thermal overload of the power semiconductors (IGBTs), the pulse frequency will be reduced automatically near 0 Hz operation. If the overload takes too long the drive will change to trip condition.

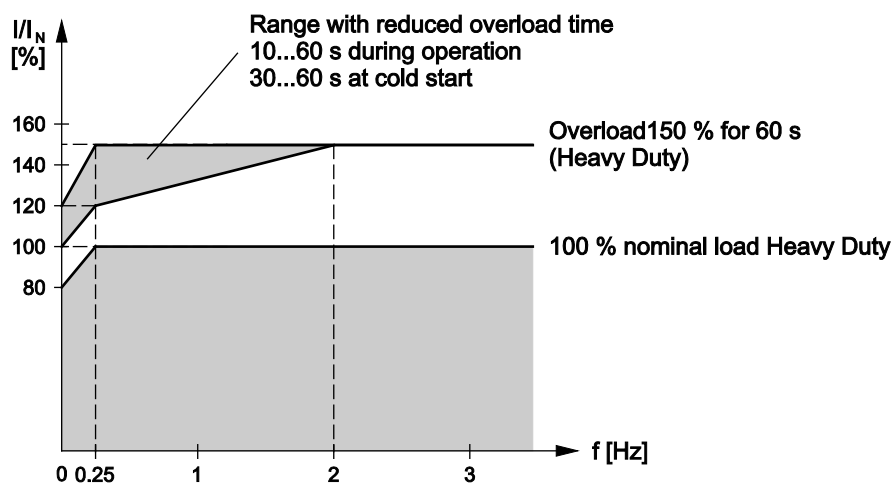

NOTE: If the frequency inverter is operated with output frequencies < 2 Hz the overload time at high overload up to 150 % is lower than 60 s. This restriction needs to be observed only for drives which continuously operate around 0 Hz and require overloads up to 150 %.

There are practically no effects on the start of a drive because even big motors have a nominal slip greater than 0.25 Hz.

Specification

Technical Data ATV960C11●4X1

Type		ATV960C11●4X1	
Nominal data		Normal Duty ND	Heavy Duty HD ⁽¹⁾
Typical motor rating P_n	$U_n = 400\text{ V}$	110 kW	90 kW
	$U_n = 440\text{ V}$	110 kW	90 kW
	$U_n = 480\text{ V}$	132 kW	110 kW
Rated output current I_n		211 A	173 A
Maximum current I_{MAX} for 60 s per 10 minutes		253 A	260 A
Input			
Rated input current I_{in} (at $I_{sc} = 22\text{ kA}$)	$U_n = 400\text{ V}$	195 A	164 A
	$U_n = 440\text{ V}$	179 A	151 A
	$U_n = 480\text{ V}$	196 A	168 A
Rated apparent power S_n	$U_n = 400\text{ V}$	135 kVA	113 kVA
	$U_n = 440\text{ V}$	136 kVA	115 kVA
	$U_n = 480\text{ V}$	163 kVA	139 kVA
Current harmonic THDi ⁽²⁾		< 48 %	
Protection for upstream cables			
Pre-fuse	$U_n = 400, 440, 480\text{ V}$	250 A gG	250 A gG
Circuit breaker I_{therm} / I_{magn}		230 A / 2 kA	200 A / 2 kA
Internal short-circuit protection			
Fuse	$U_n = 400, 440, 480\text{ V}$	250 A aR	
Characteristics			
Efficiency at I_n		0.98	
Heat losses at I_n	Total losses	2530 W	2010 W
	Control part only	380 W	300 W
Weight	Net	300 kg	
	Gross	340 kg	
Ambient conditions			
Air flow	Power part	580 m ³ /h	
	Control part	140 m ³ /h	
Sound pressure level		69 dB(A)	
Rated short-circuit current I_{sc}	Minimum ⁽³⁾	3 kA	
	Maximum ⁽⁴⁾	50 kA (100 ms)	
Mains and motor connection ⁽⁵⁾			
Typical cable		1x (3x 120 mm ²) or 2x (3x 50 mm ²)	1x (3x 95 mm ²)
Max. Cable cross section ⁽⁶⁾	Cable Cable entry ⁽⁷⁾	2x (3x 120 mm ²) or 1x (3x 240 mm ²) max. 180 mm	
Terminals per phase		2x M12	
<p>(1) For Heavy Duty HD operation parameter [Dual Rating] <i>drL</i> has to be set to [High rating] <i>HiGH</i> (see programming manual NHA80757).</p> <p>(2) For details see table under chapter "Mains Current Harmonics / Mains Voltage Distortion", page 69.</p> <p>(3) Minimum mains short-circuit current</p> <p>(4) Permitted short-circuit current when the specified pre-fuse or circuit breaker is installed</p> <p>(5) You will find further information at chapter "Mains Connection", page 67 and at chapter "Motor Connection", page 70.</p> <p>(6) Greater connection cross sections are possible with the separate connection enclosure.</p> <p>(7) Maximum possible width of cables connected next to each other in the enclosure</p>			

Dimensions IP23 for Size 1p

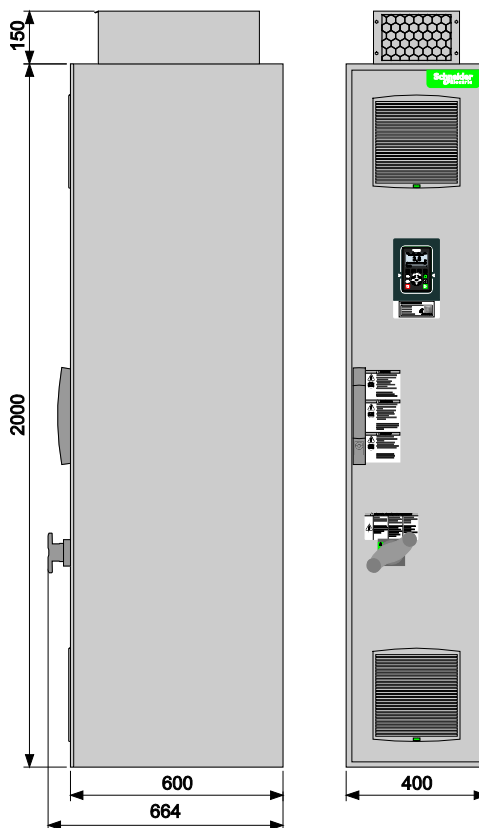

Interior View IP23 for Size 1p

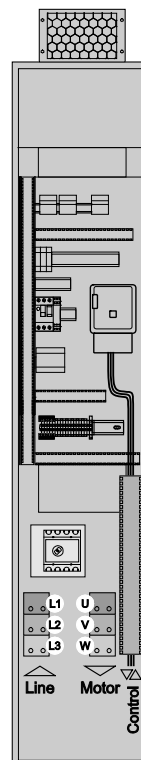

NOTE: Following customizations affect the total dimensions:

- Increased protection degree IP54
- Enclosure plinth for basic device
- Braking unit BUO
- Connection enclosure cable from top/bottom
- Multipulse supply (12-pulse)

Technical Data ATV960C13●4X1

Type		ATV960C13●4X1	
Nominal data		Normal Duty ND	Heavy Duty HD ⁽¹⁾
Typical motor rating P_n	$U_n = 400 \text{ V}$	132 kW	110 kW
	$U_n = 440 \text{ V}$	132 kW	110 kW
	$U_n = 480 \text{ V}$	160 kW	132 kW
Rated output current I_n		250 A	211 A
Maximum current I_{MAX} for 60 s per 10 minutes		300 A	317 A
Input			
Rated input current I_{in} (at $I_{SC} = 35 \text{ kA}$)	$U_n = 400 \text{ V}$	232 A	197 A
	$U_n = 440 \text{ V}$	213 A	181 A
	$U_n = 480 \text{ V}$	233 A	198 A
Rated apparent power S_n	$U_n = 400 \text{ V}$	161 kVA	136 kVA
	$U_n = 440 \text{ V}$	162 kVA	138 kVA
	$U_n = 480 \text{ V}$	194 kVA	164 kVA
Current harmonic THDi ⁽²⁾		< 48 %	
Protection for upstream cables			
Pre-fuse $U_n = 400, 440, 480 \text{ V}$		300 A gG	300 A gG
Circuit breaker I_{therm} / I_{magn}		280 A / 3 kA	240 A / 3 kA
Internal short-circuit protection			
Fuse $U_n = 400, 440, 480 \text{ V}$		315 A aR	
Characteristics			
Efficiency at I_n		0.98	
Heat losses at I_n	Total losses	3150 W	2520 W
	Control part only	450 W	360 W
Weight	Net	300 kg	
	Gross	340 kg	
Ambient conditions			
Air flow	Power part	580 m ³ /h	
	Control part	140 m ³ /h	
Sound pressure level		69 dB(A)	
Rated short-circuit current I_{SC}	Minimum ⁽³⁾	3.5 kA	
	Maximum ⁽⁴⁾	50 kA (100 ms)	
Mains and motor connection ⁽⁵⁾			
Typical cable		1x (3x 150 mm ²) or 2x (3x 70 mm ²)	1x (3x 120 mm ²) or 2x (3x 50 mm ²)
Max. Cable cross section ⁽⁶⁾	Cable	2x (3x 120 mm ²) or 1x (3x 240 mm ²)	
	Cable entry ⁽⁷⁾	max. 180 mm	
Terminals per phase		2x M12	
<p>(1) For Heavy Duty HD operation parameter [Dual Rating] drL has to be set to [High rating] $HiGH$ (see programming manual NHA80757).</p> <p>(2) For details see table under chapter "Mains Current Harmonics / Mains Voltage Distortion", page 69.</p> <p>(3) Minimum mains short-circuit current</p> <p>(4) Permitted short-circuit current when the specified pre-fuse or circuit breaker is installed</p> <p>(5) You will find further information at chapter "Mains Connection ", page 67 and at chapter "Motor Connection", page 70.</p> <p>(6) Greater connection cross sections are possible with the separate connection enclosure.</p> <p>(7) Maximum possible width of cables connected next to each other in the enclosure</p>			

Dimensions IP23 for Size 1p

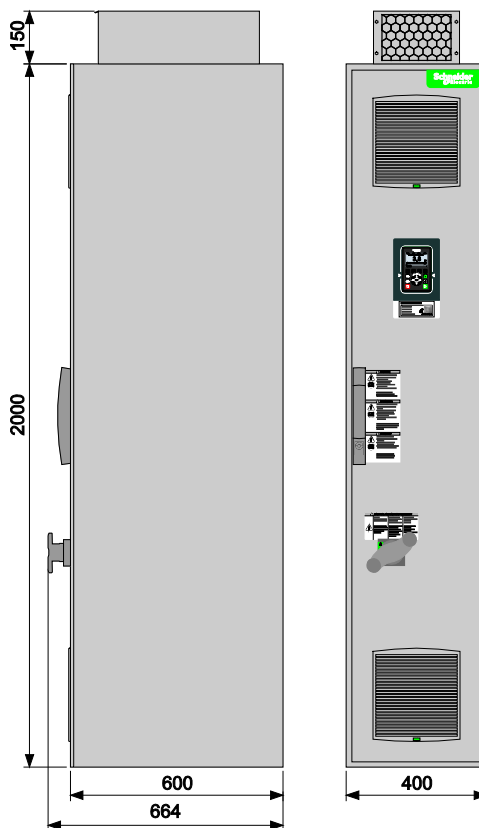

Interior View IP23 for Size 1p

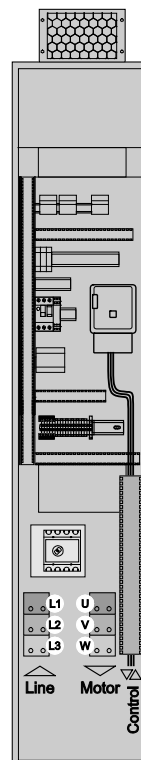

NOTE: Following customizations affect the total dimensions:

- Increased protection degree IP54
- Enclosure plinth for basic device
- Braking unit BUO
- Connection enclosure cable from top/bottom
- Multipulse supply (12-pulse)

Technical Data ATV960C16●4X1

Type		ATV960C16●4X1	
Nominal data		Normal Duty ND	Heavy Duty HD ⁽¹⁾
Typical motor rating P_n	$U_n = 400\text{ V}$	160 kW	132 kW
	$U_n = 440\text{ V}$	160 kW	132 kW
	$U_n = 480\text{ V}$	180 kW	160 kW
Rated output current I_n		302 A	250 A
Maximum current I_{MAX} for 60 s per 10 minutes		362 A	375 A
Input			
Rated input current I_{in} (at $I_{SC} = 35\text{ kA}$)	$U_n = 400\text{ V}$	277 A	232 A
	$U_n = 440\text{ V}$	254 A	213 A
	$U_n = 480\text{ V}$	258 A	233 A
Rated apparent power S_n	$U_n = 400\text{ V}$	192 kVA	161 kVA
	$U_n = 440\text{ V}$	193 kVA	162 kVA
	$U_n = 480\text{ V}$	194 kVA	215 kVA
Current harmonic THDi ⁽²⁾		< 48 %	
Protection for upstream cables			
Pre-fuse	$U_n = 400, 440, 480\text{ V}$	315 A gG	300 A gG
Circuit breaker I_{therm} / I_{magn}		315 A / 3 kA	280 A / 3 kA
Internal short-circuit protection			
Fuse	$U_n = 400, 440, 480\text{ V}$	400 A aR	
Characteristics			
Efficiency at I_n		0.98	
Heat losses at I_n	Total losses	4030 W	3120 W
	Control part only	560 W	420 W
Weight	Net	300 kg	
	Gross	340 kg	
Ambient conditions			
Air flow	Power part	580 m ³ /h	
	Control part	140 m ³ /h	
Sound pressure level		69 dB(A)	
Rated short-circuit current I_{SC}	Minimum ⁽³⁾	4 kA	
	Maximum ⁽⁴⁾	50 kA (100 ms)	
Mains and motor connection ⁽⁵⁾			
Typical cable		1x (3x 185 mm ²) or 2x (3x 95 mm ²)	1x (3x 150 mm ²) or 2x (3x 70 mm ²)
Max. Cable cross section ⁽⁶⁾	Cable	2x (3x 120 mm ²) or 1x (3x 240 mm ²)	
	Cable entry ⁽⁷⁾	max. 180 mm	
Terminals per phase		2x M12	
<p>(1) For Heavy Duty HD operation parameter [Dual Rating] <i>drL</i> has to be set to [High rating] <i>HiGH</i> (see programming manual NHA80757).</p> <p>(2) For details see table under chapter "Mains Current Harmonics / Mains Voltage Distortion", page 69.</p> <p>(3) Minimum mains short-circuit current</p> <p>(4) Permitted short-circuit current when the specified pre-fuse or circuit breaker is installed</p> <p>(5) You will find further information at chapter "Mains Connection ", page 67 and at chapter "Motor Connection", page 70.</p> <p>(6) Greater connection cross sections are possible with the separate connection enclosure.</p> <p>(7) Maximum possible width of cables connected next to each other in the enclosure</p>			

Dimensions IP23 for Size 1p

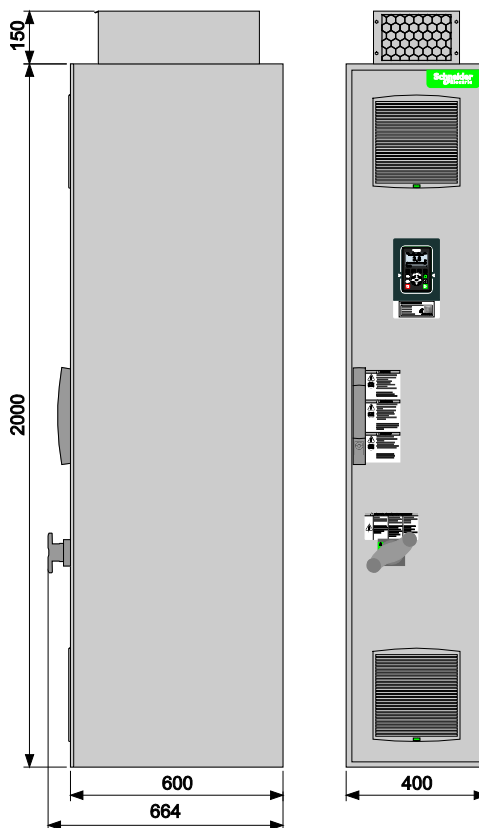

Interior View IP23 for Size 1p

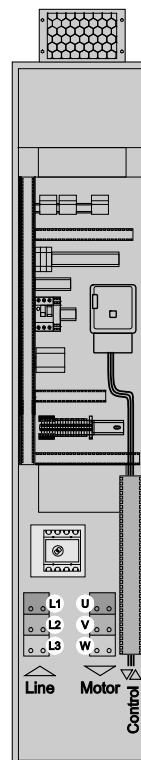

NOTE: Following customizations affect the total dimensions:

- Increased protection degree IP54
- Enclosure plinth for basic device
- Braking unit BUO
- Connection enclosure cable from top/bottom
- Multipulse supply (12-pulse)

Technical Data ATV960C20●4X1

Type		ATV960C20●4X1	
Nominal data		Normal Duty ND	Heavy Duty HD ⁽¹⁾
Typical motor rating P _n	U _n = 400 V	200 kW	160 kW
	U _n = 440 V	200 kW	160 kW
	U _n = 480 V	220 kW	180 kW
Rated output current I _n		370 A	302 A
Maximum current I _{MAX} for 60 s per 10 minutes		444 A	453 A
Input			
Rated input current I _{in} (at I _{sc} = 35 kA)	U _n = 400 V	349 A	286 A
	U _n = 440 V	321 A	264 A
	U _n = 480 V	320 A	267 A
Rated apparent power S _n	U _n = 400 V	242 kVA	198 kVA
	U _n = 440 V	245 kVA	201 kVA
	U _n = 480 V	266 kVA	222 kVA
Current harmonic THDi ⁽²⁾		< 48 %	
Protection for upstream cables			
Pre-fuse	U _n = 400, 440, 480 V	400 A gG	355 A gG
Circuit breaker I _{therm} / I _{mag}		400 A / 4 kA	330 A / 4 kA
Internal short-circuit protection			
Fuse	U _n = 400, 440, 480 V	2x 250 A aR	
Characteristics			
Efficiency at I _n		0.98	
Heat losses at I _n	Total losses	4380 W	3380 W
	Control part only	580 W	430 W
Weight	Net	400 kg	
	Gross	445 kg	
Ambient conditions			
Air flow	Power part	1160 m ³ /h	
	Control part	140 m ³ /h	
Sound pressure level		70 dB(A)	
Rated short-circuit current I _{sc}	Minimum ⁽³⁾	5.5 kA	
	Maximum ⁽⁴⁾	50 kA (100 ms)	
Mains and motor connection ⁽⁵⁾			
Typical cable		2x (3x 120 mm ²) or 3x (3x 70 mm ²)	1x (3x 185 mm ²) or 2x (3x 95 mm ²)
Max. Cable cross section ⁽⁶⁾	Cable	4x (3x 95 mm ²) or 3x (3x 120 mm ²) or 2x (3x 240 mm ²)	
	Cable entry ⁽⁷⁾	max. 360 mm	
Terminals per phase		4x M12	
<p>(1) For Heavy Duty HD operation parameter [Dual Rating] <i>drL</i> has to be set to [High rating] <i>HiGH</i> (see programming manual NHA80757).</p> <p>(2) For details see table under chapter "Mains Current Harmonics / Mains Voltage Distortion", page 69.</p> <p>(3) Minimum mains short-circuit current</p> <p>(4) Permitted short-circuit current when the specified pre-fuse or circuit breaker is installed</p> <p>(5) You will find further information at chapter "Mains Connection ", page 67 and at chapter "Motor Connection", page 70.</p> <p>(6) Greater connection cross sections are possible with the separate connection enclosure.</p> <p>(7) Maximum possible width of cables connected next to each other in the enclosure</p>			

Dimensions IP23 for Size 2p

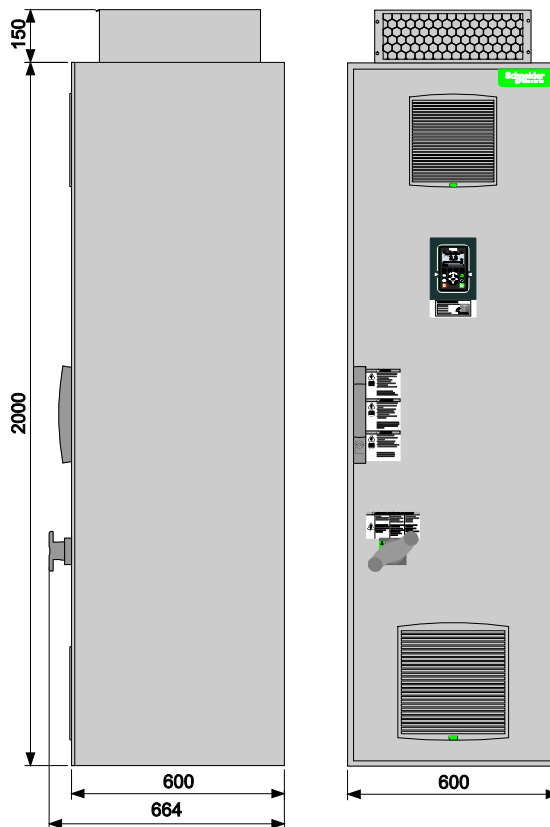

Interior View IP23 for Size 2p

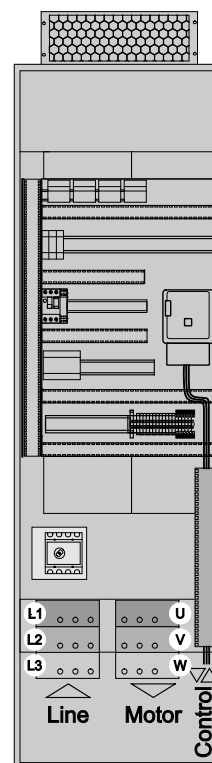

NOTE: Following customizations affect the total dimensions:

- Increased protection degree IP54
- Enclosure plinth for basic device
- Braking unit BUO
- Connection enclosure cable from top/bottom
- Multipulse supply (12-pulse)

Technical Data ATV960C25●4X1

Type		ATV960C25●4X1	
Nominal data		Normal Duty ND	Heavy Duty HD ⁽¹⁾
Typical motor rating P _n	U _n = 400 V	250 kW	200 kW
	U _n = 440 V	250 kW	200 kW
	U _n = 480 V	280 kW	220 kW
Rated output current I _n		477 A	370 A
Maximum current I _{MAX} for 60 s per 10 minutes		572 A	555 A
Input			
Rated input current I _{in} (at I _{SCC} = 50 kA)	U _n = 400 V	432 A	353 A
	U _n = 440 V	396 A	325 A
	U _n = 480 V	400 A	323 A
Rated apparent power S _n	U _n = 400 V	299 kVA	244 kVA
	U _n = 440 V	302 kVA	248 kVA
	U _n = 480 V	333 kVA	268 kVA
Current harmonic THDi ⁽²⁾		< 47 %	
Protection for upstream cables			
Pre-fuse	U _n = 400, 440, 480 V	500 A gG	400 A gG
Circuit breaker I _{therm} / I _{mag}		500 A / 5 kA	400 A / 5 kA
Internal short-circuit protection			
Fuse	U _n = 400, 440, 480 V	2x 315 A aR	
Characteristics			
Efficiency at I _n		0.98	
Heat losses at I _n	Total losses	5750 W	4340 W
	Control part only	730 W	520 W
Weight	Net	400 kg	
	Gross	445 kg	
Ambient conditions			
Air flow	Power part	1160 m ³ /h	
	Control part	140 m ³ /h	
Sound pressure level		70 dB(A)	
Rated short-circuit current I _{SCC}	Minimum ⁽³⁾	7 kA	
	Maximum ⁽⁴⁾	50 kA (100 ms)	
Mains and motor connection ⁽⁵⁾			
Typical cable		2x (3x 150 mm ²) or 3x (3x 95 mm ²)	2x (3x 120 mm ²) or 3x (3x 70 mm ²)
Max. Cable cross section ⁽⁶⁾	Cable	4x (3x 95 mm ²) or 3x (3x 120 mm ²) or 2x (3x 240 mm ²)	
	Cable entry ⁽⁷⁾	max. 360 mm	
Terminals per phase		4x M12	
<p>(1) For Heavy Duty HD operation parameter [Dual Rating] <i>drL</i> has to be set to [High rating] <i>HiGH</i> (see programming manual NHA80757).</p> <p>(2) For details see table under chapter "Mains Current Harmonics / Mains Voltage Distortion", page 69.</p> <p>(3) Minimum mains short-circuit current</p> <p>(4) Permitted short-circuit current when the specified pre-fuse or circuit breaker is installed</p> <p>(5) You will find further information at chapter "Mains Connection ", page 67 and at chapter "Motor Connection", page 70.</p> <p>(6) Greater connection cross sections are possible with the separate connection enclosure.</p> <p>(7) Maximum possible width of cables connected next to each other in the enclosure</p>			

Dimensions IP23 for Size 2p

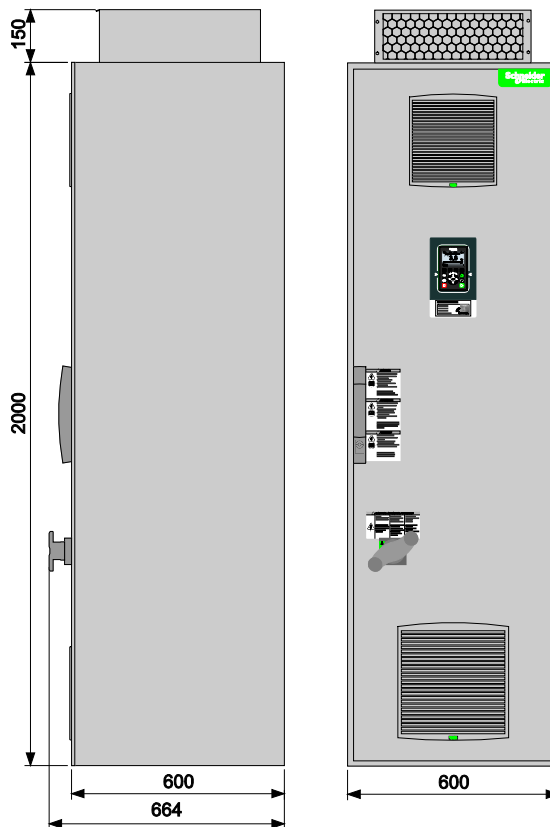

Interior View IP23 for Size 2p

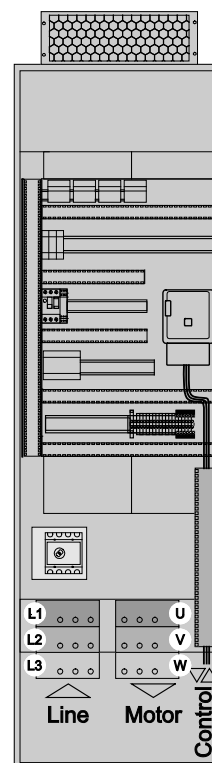

NOTE: Following customizations affect the total dimensions:

- Increased protection degree IP54
- Enclosure plinth for basic device
- Braking unit BUO
- Connection enclosure cable from top/bottom
- Multipulse supply (12-pulse)

Technical Data ATV960C31●4X1

Type		ATV960C31●4X1	
Nominal data		Normal Duty ND	Heavy Duty HD ⁽¹⁾
Typical motor rating P _n	U _n = 400 V	315 kW	250 kW
	U _n = 440 V	315 kW	250 kW
	U _n = 480 V	355 kW	280 kW
Rated output current I _n		590 A	477 A
Maximum current I _{MAX} for 60 s per 10 minutes		708 A	716 A
Input			
Rated input current I _{in} (at I _{sc} = 50 kA)	U _n = 400 V	538 A	432 A
	U _n = 440 V	493 A	396 A
	U _n = 480 V	503 A	400 A
Rated apparent power S _n	U _n = 400 V	373 kVA	299 kVA
	U _n = 440 V	375 kVA	302 kVA
	U _n = 480 V	418 kVA	333 kVA
Current harmonic THDi ⁽²⁾		< 42 %	
Protection for upstream cables			
Pre-fuse	U _n = 400, 440, 480 V	630 A gG	500 A gG
Circuit breaker I _{therm} / I _{mag}		630 A / 6 kA	500 A / 6 kA
Internal short-circuit protection			
Fuse	U _n = 400, 440, 480 V	2x 400 A aR	
Characteristics			
Efficiency at I _n		0.98	
Heat losses at I _n	Total losses	7810 W	5700 W
	Control part only	990 W	680 W
Weight	Net	400 kg	
	Gross	445 kg	
Ambient conditions			
Air flow	Power part	1160 m ³ /h	
	Control part	140 m ³ /h	
Sound pressure level		70 dB(A)	
Rated short-circuit current I _{sc}	Minimum ⁽³⁾	8 kA	
	Maximum ⁽⁴⁾	50 kA (100 ms)	
Mains and motor connection ⁽⁵⁾			
Typical cable		2x (3x 185 mm ²) or 3x (3x 120 mm ²)	2x (3x 150 mm ²) or 3x (3x 120 mm ²)
Max. Cable cross section ⁽⁶⁾	Cable	4x (3x 95 mm ²) or 3x (3x 120 mm ²) or 2x (3x 240 mm ²)	
	Cable entry ⁽⁷⁾	max. 360 mm	
Terminals per phase		4x M12	
<p>(1) For Heavy Duty HD operation parameter [Dual Rating] <i>drL</i> has to be set to [High rating] <i>HiGH</i> (see programming manual NHA80757).</p> <p>(2) For details see table under chapter "Mains Current Harmonics / Mains Voltage Distortion", page 69.</p> <p>(3) Minimum mains short-circuit current</p> <p>(4) Permitted short-circuit current when the specified pre-fuse or circuit breaker is installed</p> <p>(5) You will find further information at chapter "Mains Connection ", page 67 and at chapter "Motor Connection", page 70.</p> <p>(6) Greater connection cross sections are possible with the separate connection enclosure.</p> <p>(7) Maximum possible width of cables connected next to each other in the enclosure</p>			

Dimensions IP23 for Size 2p

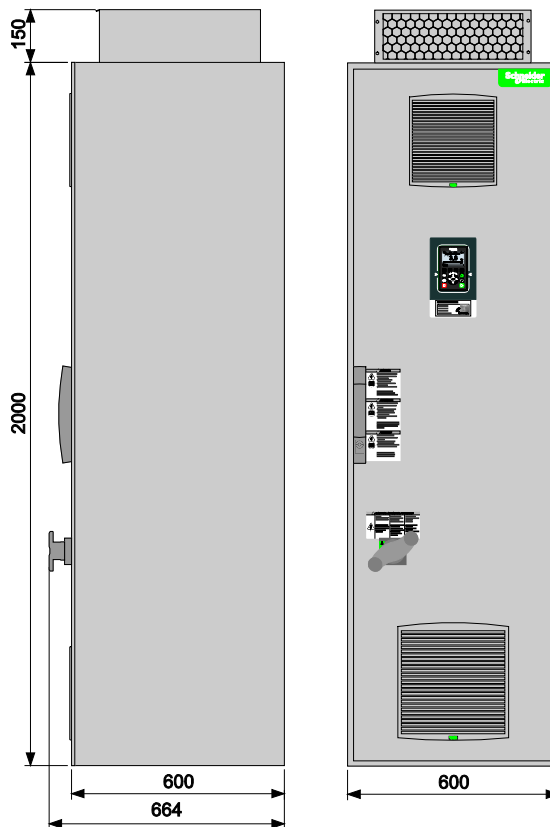

Interior View IP23 for Size 2p

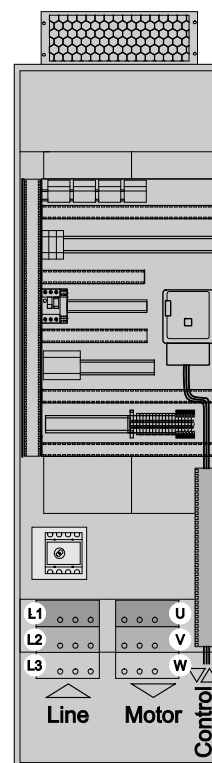

NOTE: Following customizations affect the total dimensions:

- Increased protection degree IP54
- Enclosure plinth for basic device
- Braking unit BUO
- Connection enclosure cable from top/bottom
- Multipulse supply (12-pulse)

Technical Data ATV960C35●4X1

Type		ATV960C35●4X1	
Nominal data		Normal Duty ND	Heavy Duty HD ⁽¹⁾
Typical motor rating P _n	U _n = 400 V	355 kW	280 kW
	U _n = 440 V	355 kW	280 kW
	U _n = 480 V	400 kW	315 kW
Rated output current I _n		660 A	520 A
Maximum current I _{MAX} for 60 s per 10 minutes		792 A	780 A
Input			
Rated input current I _{in} (at I _{scc} = 50 kA)	U _n = 400 V	611 A	489 A
	U _n = 440 V	559 A	450 A
	U _n = 480 V	572 A	456 A
Rated apparent power S _n	U _n = 400 V	423 kVA	339 kVA
	U _n = 440 V	426 kVA	343 kVA
	U _n = 480 V	475 kVA	379 kVA
Current harmonic THDi ⁽²⁾		< 46 %	
Protection for upstream cables			
Pre-fuse	U _n = 400, 440, 480 V	800 A gG	630 A gG
Circuit breaker I _{therm} / I _{magn}		700 A / 7 kA	580 A / 7 kA
Internal short-circuit protection			
Fuse	U _n = 400, 440, 480 V	3x 315 A aR	
Characteristics			
Efficiency at I _n		0.98	
Heat losses at I _n	Total losses	8530 W	6410 W
	Control part only	930 W	650 W
Weight	Net	650 kg	
	Gross	700 kg	
Ambient conditions			
Air flow	Power part	1740 m ³ /h	
	Control part	280 m ³ /h	
Sound pressure level		71 dB(A)	
Rated short-circuit current I _{scc}	Minimum ⁽³⁾	11 kA	
	Maximum ⁽⁴⁾	50 kA (100 ms)	
Mains and motor connection ⁽⁵⁾			
Typical cable		3x (3x 150 mm ²) or 4x (3x 95 mm ²)	2x (3x 185 mm ²) or 3x (3x 120 mm ²)
Max. Cable cross section ⁽⁶⁾	Cable	5x (3x 120 mm ²) or 4x (3x 185 mm ²) or 3x (3x 240 mm ²)	
	Cable entry ⁽⁷⁾	max. 560 mm	
Terminals per phase		5x M12	
<p>(1) For Heavy Duty HD operation parameter [Dual Rating] <i>drL</i> has to be set to [High rating] <i>HiGH</i> (see programming manual NHA80757).</p> <p>(2) For details see table under chapter "Mains Current Harmonics / Mains Voltage Distortion", page 69.</p> <p>(3) Minimum mains short-circuit current</p> <p>(4) Permitted short-circuit current when the specified pre-fuse or circuit breaker is installed</p> <p>(5) You will find further information at chapter "Mains Connection", page 67 and at chapter "Motor Connection", page 70.</p> <p>(6) Greater connection cross sections are possible with the separate connection enclosure.</p> <p>(7) Maximum possible width of cables connected next to each other in the enclosure</p>			

Dimensions IP23 for Size 3p

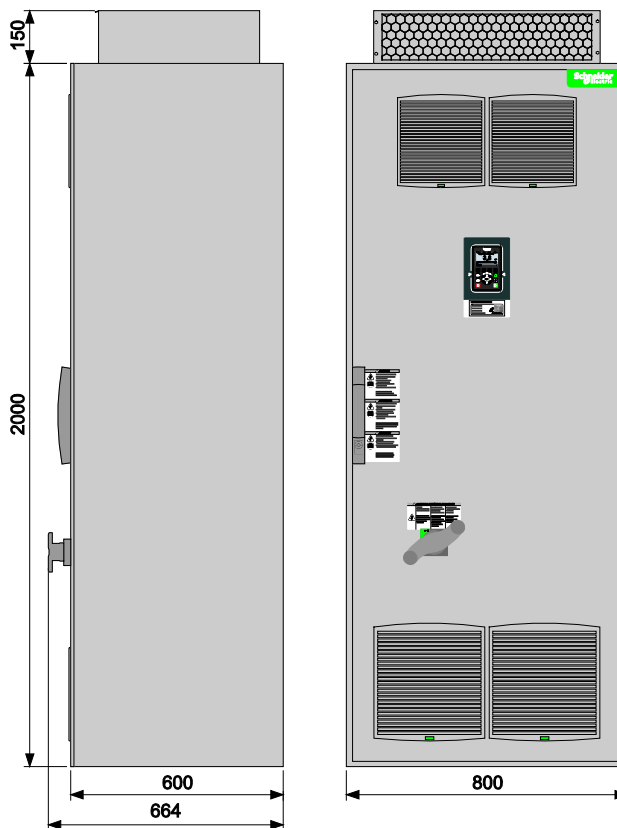

Interior View IP23 for Size 3p

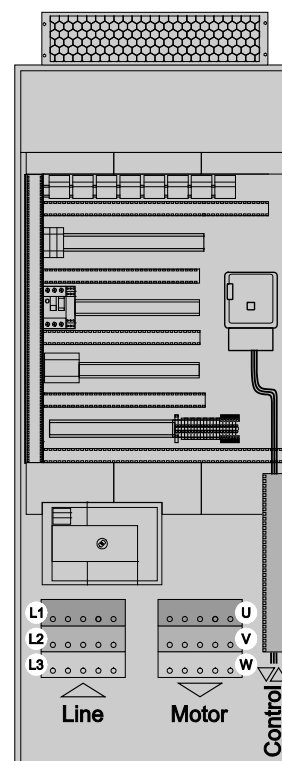

NOTE: Following customizations affect the total dimensions:

- Increased protection degree IP54
- Enclosure plinth for basic device
- Braking unit BUO
- Connection enclosure cable from top/bottom
- Multipulse supply (12-pulse)

Technical Data ATV960C40●4X1

Type		ATV960C40●4X1	
Nominal data		Normal Duty ND	Heavy Duty HD ⁽¹⁾
Typical motor rating P _n	U _n = 400 V	400 kW	315 kW
	U _n = 440 V	400 kW	315 kW
	U _n = 480 V	450 kW	355 kW
Rated output current I _n		730 A	590 A
Maximum current I _{MAX} for 60 s per 10 minutes		876 A	885 A
Input			
Rated input current I _{in} (at I _{scc} = 50 kA)	U _n = 400 V	681 A	545 A
	U _n = 440 V	623 A	501 A
	U _n = 480 V	637 A	510 A
Rated apparent power S _n	U _n = 400 V	472 kVA	378 kVA
	U _n = 440 V	475 kVA	382 kVA
	U _n = 480 V	530 kVA	424 kVA
Current harmonic THDi ⁽²⁾		< 43 %	
Protection for upstream cables			
Pre-fuse	U _n = 400, 440, 480 V	800 A gG	630 A gG
Circuit breaker I _{therm} / I _{magn}		780 A / 8 kA	630 A / 8 kA
Internal short-circuit protection			
Fuse	U _n = 400, 440, 480 V	3x 315 A aR	
Characteristics			
Efficiency at I _n		0.98	
Heat losses at I _n	Total losses	9900 W	7370 W
	Control part only	1120 W	770 W
Weight	Net	650 kg	
	Gross	700 kg	
Ambient conditions			
Air flow	Power part	1740 m ³ /h	
	Control part	280 m ³ /h	
Sound pressure level		71 dB(A)	
Rated short-circuit current I _{scc}	Minimum ⁽³⁾	11 kA	
	Maximum ⁽⁴⁾	50 kA (100 ms)	
Mains and motor connection ⁽⁵⁾			
Typical cable		3x (3x 185 mm ²) or 4x (3x 120 mm ²)	3x (3x 120 mm ²) or 4x (3x 95 mm ²)
Max. Cable cross section ⁽⁶⁾	Cable	5x (3x 120 mm ²) or 4x (3x 185 mm ²) or 3x (3x 240 mm ²)	
	Cable entry ⁽⁷⁾	max. 560 mm	
Terminals per phase		5x M12	
<p>(1) For Heavy Duty HD operation parameter [Dual Rating] <i>drL</i> has to be set to [High rating] <i>HiGH</i> (see programming manual NHA80757).</p> <p>(2) For details see table under chapter "Mains Current Harmonics / Mains Voltage Distortion", page 69.</p> <p>(3) Minimum mains short-circuit current</p> <p>(4) Permitted short-circuit current when the specified pre-fuse or circuit breaker is installed</p> <p>(5) You will find further information at chapter "Mains Connection", page 67 and at chapter "Motor Connection", page 70.</p> <p>(6) Greater connection cross sections are possible with the separate connection enclosure.</p> <p>(7) Maximum possible width of cables connected next to each other in the enclosure</p>			

Dimensions IP23 for Size 3p

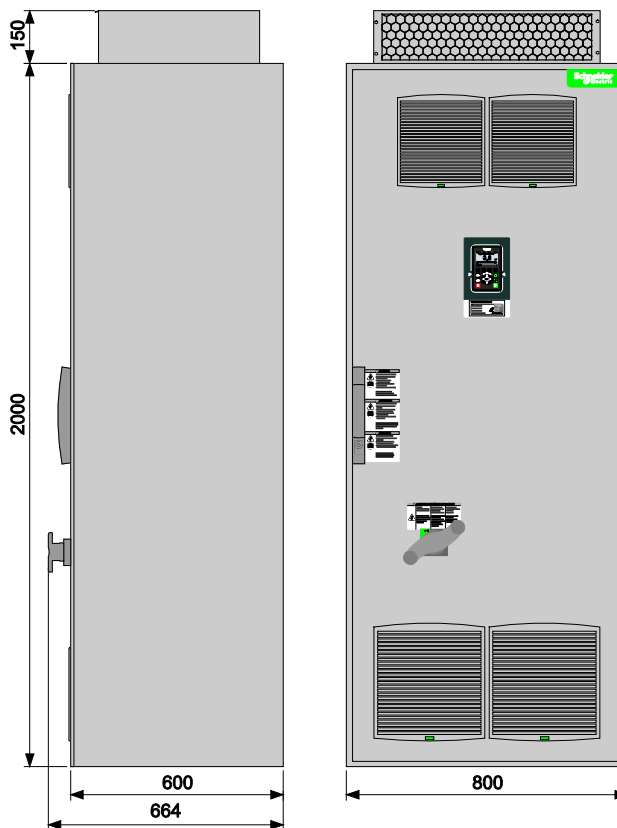

Interior View IP23 for Size 3p

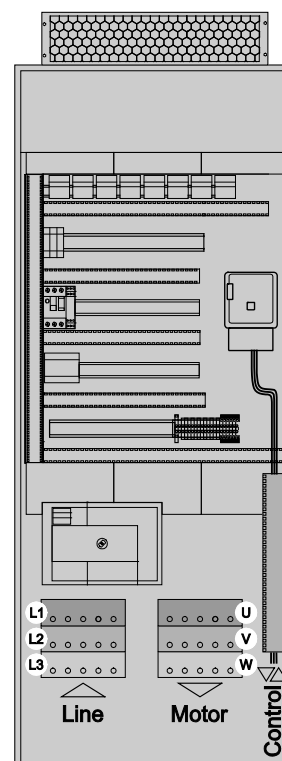

NOTE: Following customizations affect the total dimensions:

- Increased protection degree IP54
- Enclosure plinth for basic device
- Braking unit BUO
- Connection enclosure cable from top/bottom
- Multipulse supply (12-pulse)

Technical Data ATV960C45●4X1

Type		ATV960C45●4X1	
Nominal data		Normal Duty ND	Heavy Duty HD ⁽¹⁾
Typical motor rating P_n	$U_n = 400\text{ V}$	450 kW	355 kW
	$U_n = 440\text{ V}$	450 kW	355 kW
	$U_n = 480\text{ V}$	500 kW	400 kW
Rated output current I_n		830 A	660 A
Maximum current I_{MAX} for 60 s per 10 minutes		996 A	990 A
Input			
Rated input current I_{in} (at $I_{SC} = 50\text{ kA}$)	$U_n = 400\text{ V}$	764 A	611 A
	$U_n = 440\text{ V}$	697 A	559 A
	$U_n = 480\text{ V}$	706 A	572 A
Rated apparent power S_n	$U_n = 400\text{ V}$	529 kVA	423 kVA
	$U_n = 440\text{ V}$	531 kVA	426 kVA
	$U_n = 480\text{ V}$	587 kVA	475 kVA
Current harmonic THDi ⁽²⁾		< 41 %	
Protection for upstream cables			
Pre-fuse	$U_n = 400, 440, 480\text{ V}$	1000 A gG	800 A gG
Circuit breaker I_{therm} / I_{magn}		900 A / 9 kA	720 A / 9 kA
Internal short-circuit protection			
Fuse	$U_n = 400, 440, 480\text{ V}$	3x 400 A aR	
Characteristics			
Efficiency at I_n		0.98	
Heat losses at I_n	Total losses	11520 W	8460 W
	Control part only	1270 W	860 W
Weight	Net	650 kg	
	Gross	700 kg	
Ambient conditions			
Air flow	Power part	1740 m ³ /h	
	Control part	280 m ³ /h	
Sound pressure level		71 dB(A)	
Rated short-circuit current I_{SC}	Minimum ⁽³⁾	13 kA	
	Maximum ⁽⁴⁾	50 kA (100 ms)	
Mains and motor connection ⁽⁵⁾			
Typical cable		4x (3x 150 mm ²) or 5x (3x 120 mm ²)	3x (3x 150 mm ²) or 4x (3x 95 mm ²)
Max. Cable cross section ⁽⁶⁾	Cable	5x (3x 120 mm ²) or 4x (3x 185 mm ²) or 3x (3x 240 mm ²)	
	Cable entry ⁽⁷⁾	max. 560 mm	
Terminals per phase		5x M12	
<p>(1) For Heavy Duty HD operation parameter [Dual Rating] drL has to be set to [High rating] $HiGH$ (see programming manual NHA80757).</p> <p>(2) For details see table under chapter "Mains Current Harmonics / Mains Voltage Distortion", page 69.</p> <p>(3) Minimum mains short-circuit current</p> <p>(4) Permitted short-circuit current when the specified pre-fuse or circuit breaker is installed</p> <p>(5) You will find further information at chapter "Mains Connection ", page 67 and at chapter "Motor Connection", page 70.</p> <p>(6) Greater connection cross sections are possible with the separate connection enclosure.</p> <p>(7) Maximum possible width of cables connected next to each other in the enclosure</p>			

Dimensions IP23 for Size 3p

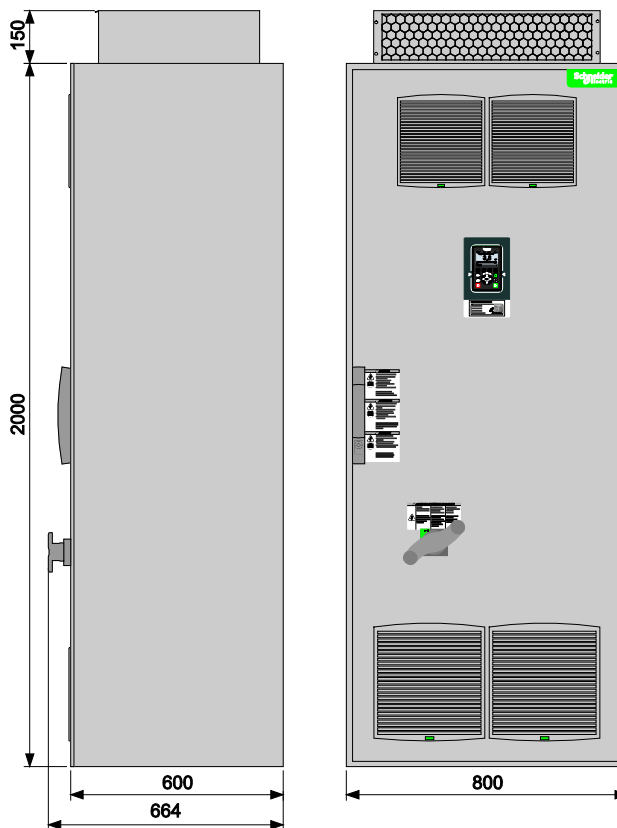

Interior View IP23 for Size 3p

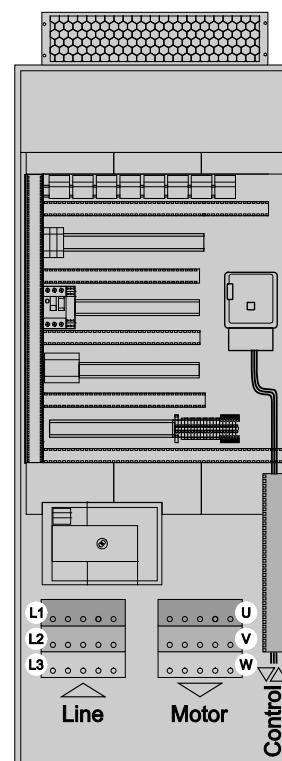

NOTE: Following customizations affect the total dimensions:

- Increased protection degree IP54
- Enclosure plinth for basic device
- Braking unit BUO
- Connection enclosure cable from top/bottom
- Multipulse supply (12-pulse)

Technical Data ATV960C50●4X1

Type		ATV960C50●4X1	
Nominal data		Normal Duty ND	Heavy Duty HD ⁽¹⁾
Typical motor rating P _n	U _n = 400 V	500 kW	400 kW
	U _n = 440 V	500 kW	400 kW
	U _n = 480 V	560 kW	450 kW
Rated output current I _n		900 A	730 A
Maximum current I _{MAX} for 60 s per 10 minutes		1080 A	1095 A
Input			
Rated input current I _{in} (at I _{scc} = 50 kA)	U _n = 400 V	846 A	681 A
	U _n = 440 V	771 A	623 A
	U _n = 480 V	789 A	637 A
Rated apparent power S _n	U _n = 400 V	586 kVA	472 kVA
	U _n = 440 V	588 kVA	475 kVA
	U _n = 480 V	656 kVA	530 kVA
Current harmonic THDi ⁽²⁾		< 39 %	
Protection for upstream cables			
Pre-fuse	U _n = 400, 440, 480 V	1000 A gG	800 A gG
Circuit breaker I _{therm} / I _{mag}		1000 A / 10 kA	800 A / 10 kA
Internal short-circuit protection			
Fuse	U _n = 400, 440, 480 V	3x 400 A aR	
Characteristics			
Efficiency at I _n		0.98	
Heat losses at I _n	Total losses	13330 W	9800 W
	Control part only	1530 W	1020 W
Weight	Net	650 kg	
	Gross	700 kg	
Ambient conditions			
Air flow	Power part	1740 m ³ /h	
	Control part	280 m ³ /h	
Sound pressure level		71 dB(A)	
Rated short-circuit current I _{scc}	Minimum ⁽³⁾	13 kA	
	Maximum ⁽⁴⁾	50 kA (100 ms)	
Mains and motor connection ⁽⁵⁾			
Typical cable		4x (3x 185 mm ²) or 5x (3x 120 mm ²)	3x (3x 185 mm ²) or 4x (3x 120 mm ²)
Max. Cable cross section ⁽⁶⁾	Cable	5x (3x 120 mm ²) or 4x (3x 185 mm ²) or 3x (3x 240 mm ²)	
	Cable entry ⁽⁷⁾	max. 560 mm	
Terminals per phase		5x M12	
<p>(1) For Heavy Duty HD operation parameter [Dual Rating] <i>drL</i> has to be set to [High rating] <i>HiGH</i> (see programming manual NHA80757).</p> <p>(2) For details see table under chapter "Mains Current Harmonics / Mains Voltage Distortion", page 69.</p> <p>(3) Minimum mains short-circuit current</p> <p>(4) Permitted short-circuit current when the specified pre-fuse or circuit breaker is installed</p> <p>(5) You will find further information at chapter "Mains Connection ", page 67 and at chapter "Motor Connection", page 70.</p> <p>(6) Greater connection cross sections are possible with the separate connection enclosure.</p> <p>(7) Maximum possible width of cables connected next to each other in the enclosure</p>			

Dimensions IP23 for Size 3p

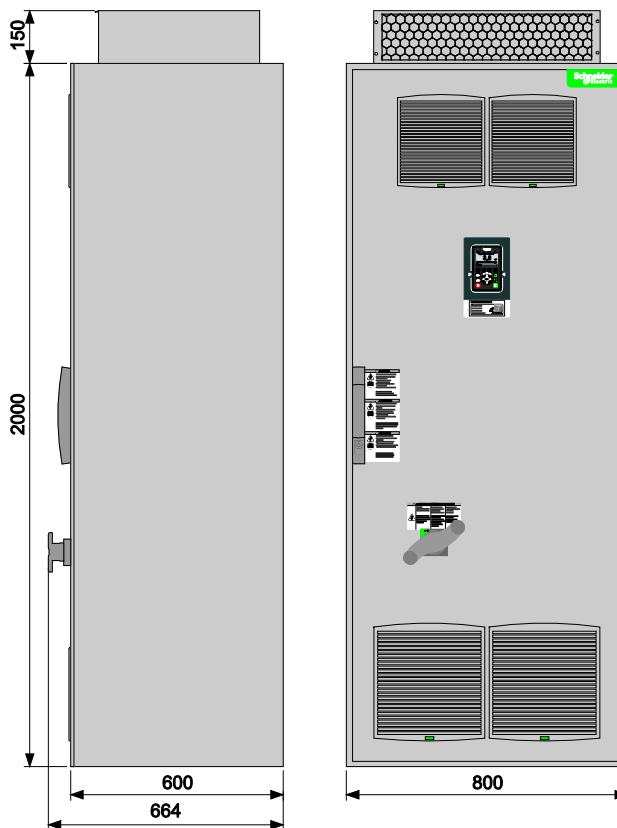

Interior View IP23 for Size 3p

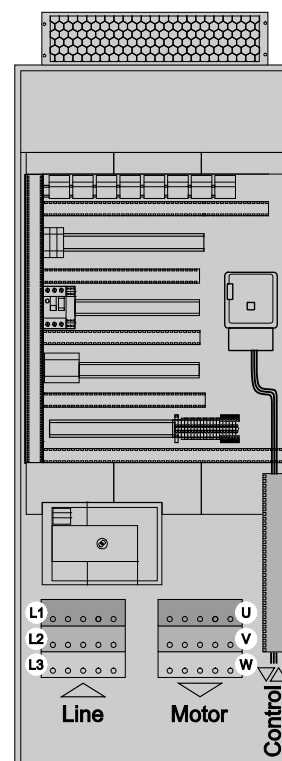

NOTE: Following customizations affect the total dimensions:

- Increased protection degree IP54
- Enclosure plinth for basic device
- Braking unit BUO
- Connection enclosure cable from top/bottom
- Multipulse supply (12-pulse)

Technical Data ATV960C56●4X1

Type		ATV960C56●4X1	
Nominal data		Normal Duty ND	Heavy Duty HD ⁽¹⁾
Typical motor rating P _n	U _n = 400 V	560 kW	450 kW
	U _n = 440 V	560 kW	450 kW
	U _n = 480 V	630 kW	500 kW
Rated output current I _n		1020 A	830 A
Maximum current I _{MAX} for 60 s per 10 minutes		1224 A	1245 A
Input			
Rated input current I _{in} (at I _{SCC} = 50 kA)	U _n = 400 V	948 A	767 A
	U _n = 440 V	865 A	703 A
	U _n = 480 V	888 A	711 A
Rated apparent power S _n	U _n = 400 V	656 kVA	531 kVA
	U _n = 440 V	660 kVA	536 kVA
	U _n = 480 V	739 kVA	591 kVA
Current harmonic THDi ⁽²⁾		< 40 %	
Protection for upstream cables			
Pre-fuse	U _n = 400, 440, 480 V	1250 A gG	1000 A gG
Circuit breaker I _{therm} / I _{magN}		1100 A / 11 kA	900 A / 11 kA
Internal short-circuit protection			
Fuse	U _n = 400, 440, 480 V	4x 400 A aR	
Characteristics			
Efficiency at I _n		0.98	
Heat losses at I _n	Total losses	13950 W	10500 W
	Control part only	1500 W	1050 W
Weight	Net	850 kg	
	Gross	910 kg	
Ambient conditions			
Air flow	Power part	2320 m ³ /h	
	Control part	280 m ³ /h	
Sound pressure level		73 dB(A)	
Rated short-circuit current I _{SCC}	Minimum ⁽³⁾	15 kA	
	Maximum ⁽⁴⁾	50 kA (100 ms)	
Mains and motor connection ⁽⁵⁾			
Typical cable		4x (3x 185 mm ²) or 5x (3x 150 mm ²)	4x (3x 150 mm ²) or 5x (3x 120 mm ²)
Max. Cable cross section ⁽⁶⁾	Cable	6x (3x 185 mm ²) or 5x (3x 240 mm ²)	
	Cable entry mains ⁽⁷⁾	max. 360 mm	
	Cable entry motor ⁽⁷⁾	max. 360 mm	
Terminals per phase		6x M12	
<p>(1) For Heavy Duty HD operation parameter [Dual Rating] <i>drL</i> has to be set to [High rating] <i>HiGH</i> (see programming manual NHA80757).</p> <p>(2) For details see table under chapter "Mains Current Harmonics / Mains Voltage Distortion", page 69.</p> <p>(3) Minimum mains short-circuit current</p> <p>(4) Permitted short-circuit current when the specified pre-fuse or circuit breaker is installed</p> <p>(5) You will find further information at chapter "Mains Connection", page 67 and at chapter "Motor Connection", page 70.</p> <p>(6) Greater connection cross sections are possible with the separate connection enclosure.</p> <p>(7) Maximum possible width of cables connected next to each other in the enclosure</p>			

Dimensions IP23 for Size 4p

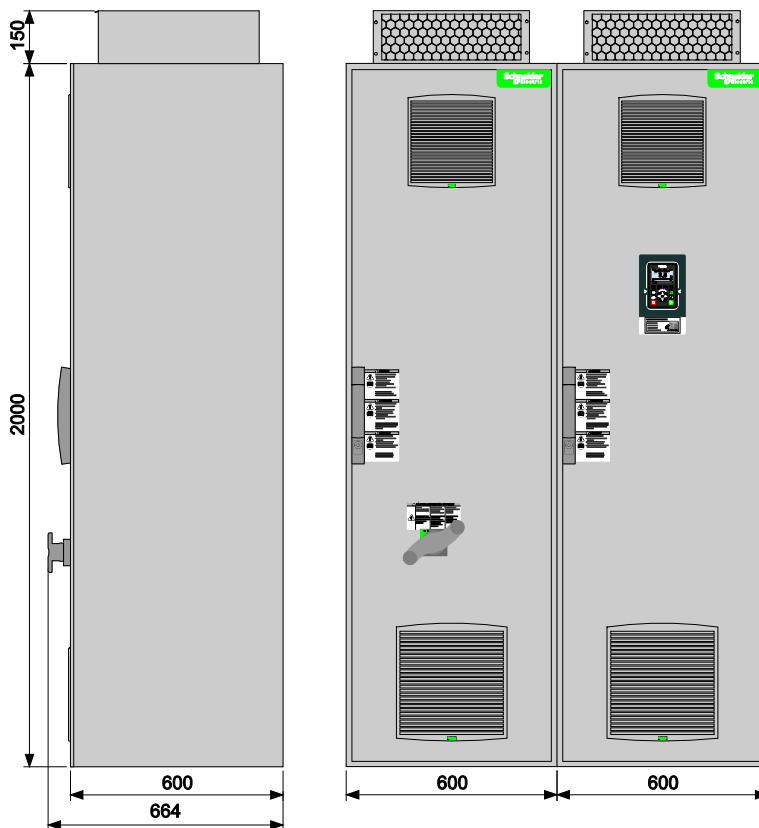

Interior View IP23 for Size 4p

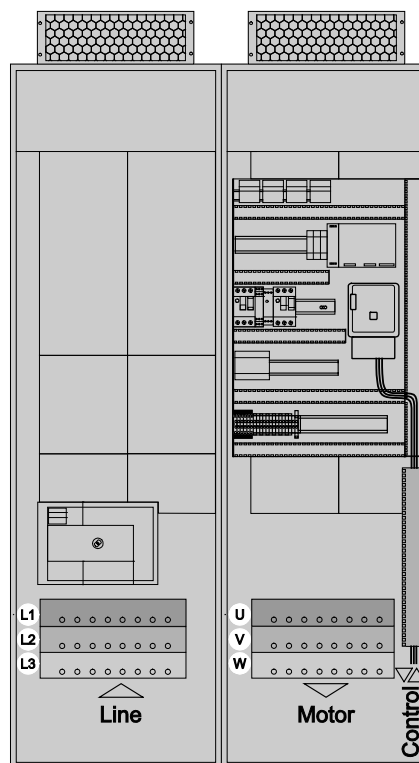

NOTE: Following customizations affect the total dimensions:

- Increased protection degree IP54
- Enclosure plinth for basic device
- Braking unit BUO
- Connection enclosure cable from top/bottom
- Multipulse supply (12-pulse)

Technical Data ATV960C63●4X1

Type		ATV960C63●4X1	
Nominal data		Normal Duty ND	Heavy Duty HD ⁽¹⁾
Typical motor rating P _n	U _n = 400 V	630 kW	500 kW
	U _n = 440 V	630 kW	500 kW
	U _n = 480 V	710 kW	560 kW
Rated output current I _n		1140 A	900 A
Maximum current I _{MAX} for 60 s per 10 minutes		1368 A	1350 A
Input			
Rated input current I _{in} (at I _{sc} = 50 kA)	U _n = 400 V	1058 A	849 A
	U _n = 440 V	965 A	776 A
	U _n = 480 V	993 A	794 A
Rated apparent power S _n	U _n = 400 V	733 kVA	588 kVA
	U _n = 440 V	735 kVA	592 kVA
	U _n = 480 V	826 kVA	660 kVA
Current harmonic THDi ⁽²⁾		< 38 %	
Protection for upstream cables			
Pre-fuse	U _n = 400, 440, 480 V	1250 A gG	1000 A gG
Circuit breaker I _{therm} / I _{mag}		1250 A / 12 kA	1000 A / 12 kA
Internal short-circuit protection			
Fuse	U _n = 400, 440, 480 V	4x 400 A aR	
Characteristics			
Efficiency at I _n		0.98	
Heat losses at I _n	Total losses	16250 W	12000 W
	Control part only	1800 W	1250 W
Weight	Net	850 kg	
	Gross	910 kg	
Ambient conditions			
Air flow	Power part	2320 m ³ /h	
	Control part	280 m ³ /h	
Sound pressure level		73 dB(A)	
Rated short-circuit current I _{sc}	Minimum ⁽³⁾	17 kA	
	Maximum ⁽⁴⁾	50 kA (100 ms)	
Mains and motor connection ⁽⁵⁾			
Typical cable		4x (3x 240 mm ²) or 5x (3x 185 mm ²) or 6x (3x 120 mm ²)	4x (3x 185 mm ²) or 5x (3x 120 mm ²)
Max. Cable cross section ⁽⁶⁾	Cable	6x (3x 185 mm ²) or 5x (3x 240 mm ²)	
	Cable entry mains ⁽⁷⁾	max. 360 mm	
	Cable entry motor ⁽⁷⁾	max. 360 mm	
Terminals per phase		6x M12	
<p>(1) For Heavy Duty HD operation parameter [Dual Rating] <i>drL</i> has to be set to [High rating] <i>HiGH</i> (see programming manual NHA80757).</p> <p>(2) For details see table under chapter "Mains Current Harmonics / Mains Voltage Distortion", page 69.</p> <p>(3) Minimum mains short-circuit current</p> <p>(4) Permitted short-circuit current when the specified pre-fuse or circuit breaker is installed</p> <p>(5) You will find further information at chapter "Mains Connection", page 67 and at chapter "Motor Connection", page 70.</p> <p>(6) Greater connection cross sections are possible with the separate connection enclosure.</p> <p>(7) Maximum possible width of cables connected next to each other in the enclosure</p>			

Dimensions IP23 for Size 4p

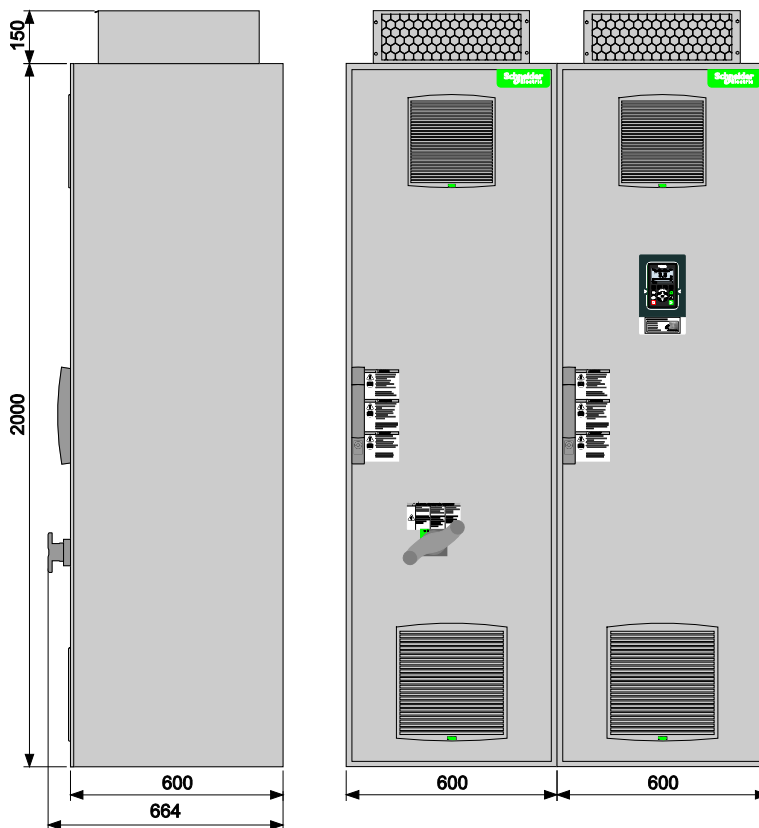

Interior View IP23 for Size 4p

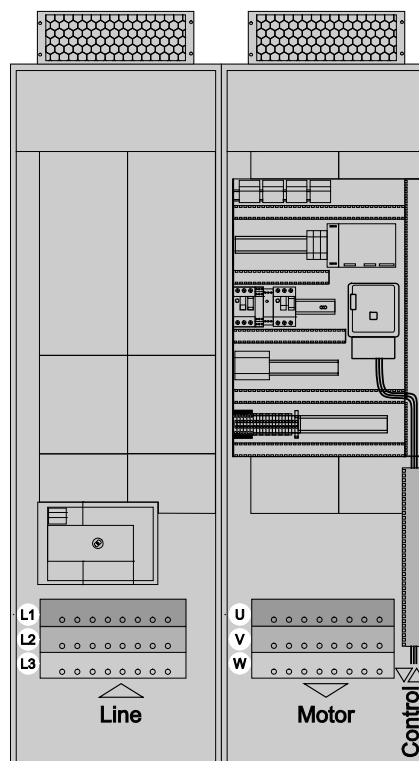

NOTE: Following customizations affect the total dimensions:

- Increased protection degree IP54
- Enclosure plinth for basic device
- Braking unit BUO
- Connection enclosure cable from top/bottom
- Multipulse supply (12-pulse)

Technical Data ATV960C71●4X1

Type		ATV960C71●4X1	
Nominal data		Normal Duty ND	Heavy Duty HD ⁽¹⁾
Typical motor rating P _n	U _n = 400 V	710 kW	560 kW
	U _n = 440 V	710 kW	560 kW
	U _n = 480 V	800 kW	630 kW
Rated output current I _n		1260 A	1020 A
Maximum current I _{MAX} for 60 s per 10 minutes		1512 A	1530 A
Input			
Rated input current I _{in} (at I _{SC} = 50 kA)	U _n = 400 V	1192 A	951 A
	U _n = 440 V	1087 A	869 A
	U _n = 480 V	1119 A	893 A
Rated apparent power S _n	U _n = 400 V	826 kVA	659 kVA
	U _n = 440 V	829 kVA	663 kVA
	U _n = 480 V	931 kVA	742 kVA
Current harmonic THDi ⁽²⁾		< 38 %	
Protection for upstream cables			
Pre-fuse	U _n = 400, 440, 480 V	1600 A gG	1250 A gG
Circuit breaker I _{therm} / I _{mag}		1400 A / 14 kA	1100 A / 14 kA
Internal short-circuit protection			
Fuse	U _n = 400, 440, 480 V	5x 400 A aR	
Characteristics			
Efficiency at I _n		0.98	
Heat losses at I _n	Total losses	17600 W	13000 W
	Control part only	1900 W	1300 W
Weight	Net	1100 kg	
	Gross	1165 kg	
Ambient conditions			
Air flow	Power part	2900 m ³ /h	
	Control part	420 m ³ /h	
Sound pressure level		74 dB(A)	
Rated short-circuit current I _{SC}	Minimum ⁽³⁾	18 kA	
	Maximum ⁽⁴⁾	50 kA (100 ms)	
Mains and motor connection ⁽⁵⁾			
Typical cable		5x (3x 185 mm ²) or 6x (3x 150 mm ²)	4x (3x 185 mm ²) or 5x (3x 150 mm ²)
Max. Cable cross section ⁽⁶⁾	Cable	8x (3x 120 mm ²) or 6x (3x 240 mm ²)	
	Cable entry mains ⁽⁷⁾	max. 560 mm	
	Cable entry motor ⁽⁷⁾	max. 360 mm	
Terminals per phase		8x M12	
<p>(1) For Heavy Duty HD operation parameter [Dual Rating] <i>drL</i> has to be set to [High rating] <i>HiGH</i> (see programming manual NHA80757).</p> <p>(2) For details see table under chapter "Mains Current Harmonics / Mains Voltage Distortion", page 69.</p> <p>(3) Minimum mains short-circuit current</p> <p>(4) Permitted short-circuit current when the specified pre-fuse or circuit breaker is installed</p> <p>(5) You will find further information at chapter "Mains Connection", page 67 and at chapter "Motor Connection", page 70.</p> <p>(6) Greater connection cross sections are possible with the separate connection enclosure.</p> <p>(7) Maximum possible width of cables connected next to each other in the enclosure</p>			

Dimensions IP23 for Size 5p

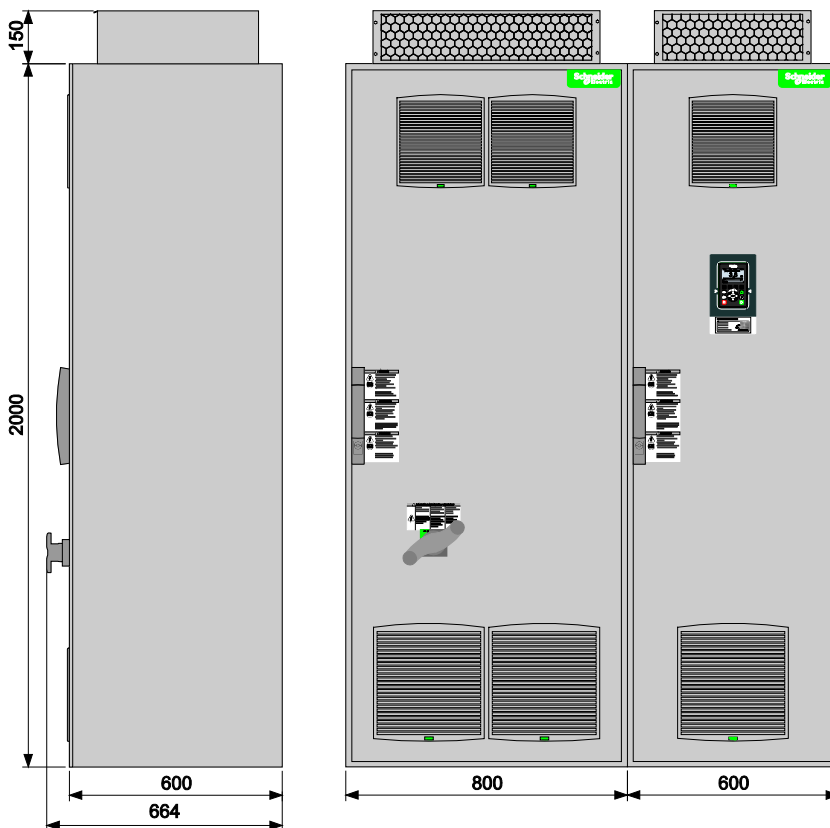

Interior View IP23 for Size 5p

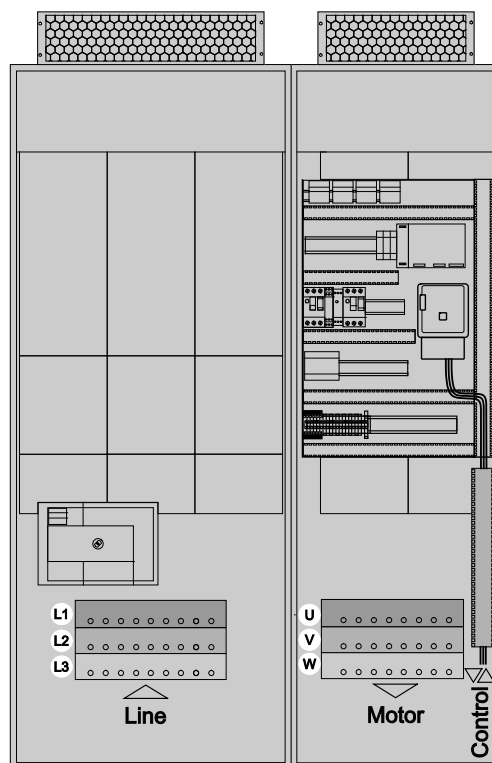

NOTE: Following customizations affect the total dimensions:

- Increased protection degree IP54
- Enclosure plinth for basic device
- Braking unit BUO
- Connection enclosure cable from top/bottom
- Multipulse supply (12-pulse)

Technical Data ATV960C80●4X1

Type		ATV960C80●4X1	
Nominal data		Normal Duty ND	Heavy Duty HD ⁽¹⁾
Typical motor rating P _n	U _n = 400 V	800 kW	630 kW
	U _n = 440 V	800 kW	630 kW
	U _n = 480 V	900 kW	710 kW
Rated output current I _n		1420 A	1140 A
Maximum current I _{MAX} for 60 s per 10 minutes		1704 A	1710 A
Input			
Rated input current I _{in} (at I _{sc} = 50 kA)	U _n = 400 V	1335 A	1061 A
	U _n = 440 V	1216 A	968 A
	U _n = 480 V	1257 A	997 A
Rated apparent power S _n	U _n = 400 V	925 kVA	735 kVA
	U _n = 440 V	927 kVA	738 kVA
	U _n = 480 V	1045 kVA	828 kVA
Current harmonic THDi ⁽²⁾		< 36 %	
Protection for upstream cables			
Pre-fuse	U _n = 400, 440, 480 V	1600 A gG	1250 A gG
Circuit breaker I _{therm} / I _{mag}		1600 A / 16 kA	1250 A / 16 kA
Internal short-circuit protection			
Fuse	U _n = 400, 440, 480 V	5x 400 A aR	
Characteristics			
Efficiency at I _n		0.98	
Heat losses at I _n	Total losses	20600 W	15080 W
	Control part only	2300 W	1580 W
Weight	Net	1100 kg	
	Gross	1165 kg	
Ambient conditions			
Air flow	Power part	2900 m ³ /h	
	Control part	420 m ³ /h	
Sound pressure level		74 dB(A)	
Rated short-circuit current I _{sc}	Minimum ⁽³⁾	20 kA	
	Maximum ⁽⁴⁾	50 kA (100 ms)	
Mains and motor connection ⁽⁵⁾			
Typical cable		5x (3x 240 mm ²) or 6x (3x 185 mm ²)	4x (3x 240 mm ²) or 5x (3x 185 mm ²) or 6x (3x 120 mm ²)
Max. Cable cross section ⁽⁶⁾	Cable	8x (3x 120 mm ²) or 6x (3x 240 mm ²)	
	Cable entry mains ⁽⁷⁾	max. 560 mm	
	Cable entry motor ⁽⁷⁾	max. 360 mm	
Terminals per phase		8x M12	
<p>(1) For Heavy Duty HD operation parameter [Dual Rating] <i>drL</i> has to be set to [High rating] <i>HiGH</i> (see programming manual NHA80757).</p> <p>(2) For details see table under chapter "Mains Current Harmonics / Mains Voltage Distortion", page 69.</p> <p>(3) Minimum mains short-circuit current</p> <p>(4) Permitted short-circuit current when the specified pre-fuse or circuit breaker is installed</p> <p>(5) You will find further information at chapter "Mains Connection", page 67 and at chapter "Motor Connection", page 70.</p> <p>(6) Greater connection cross sections are possible with the separate connection enclosure.</p> <p>(7) Maximum possible width of cables connected next to each other in the enclosure</p>			

Dimensions IP23 for Size 5p

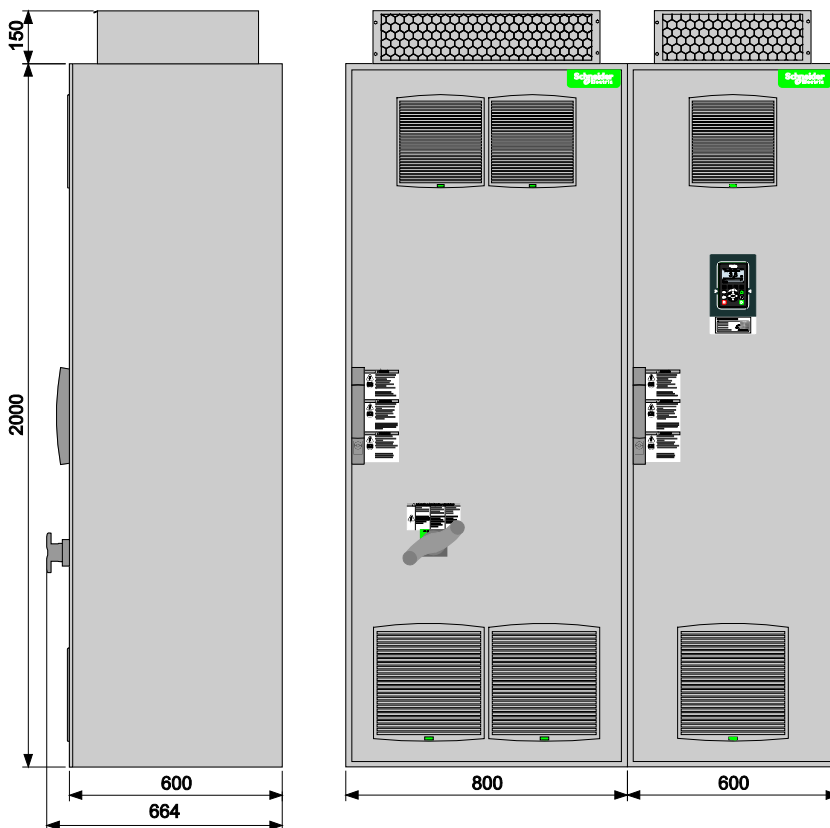

Interior View IP23 for Size 5p

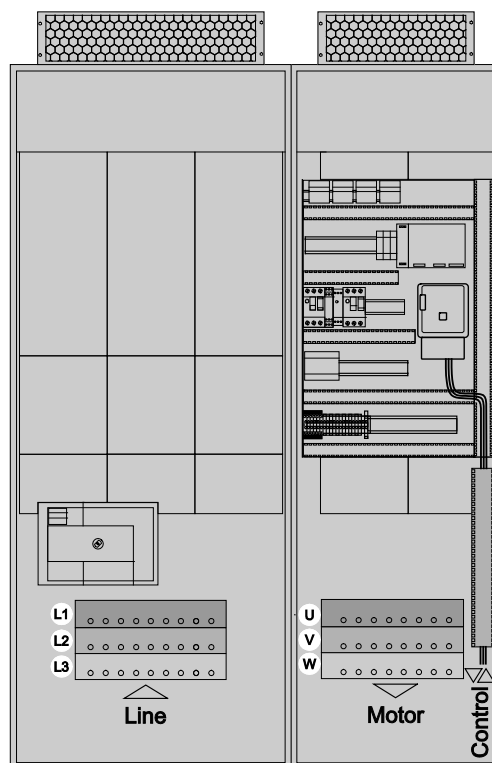

NOTE: Following customizations affect the total dimensions:

- Increased protection degree IP54
- Enclosure plinth for basic device
- Braking unit BUO
- Connection enclosure cable from top/bottom
- Multipulse supply (12-pulse)

Circuit Diagram

The following diagram shows the typical wiring of the frequency inverter which may be required for protection of the plant or the device, depending on the use case.

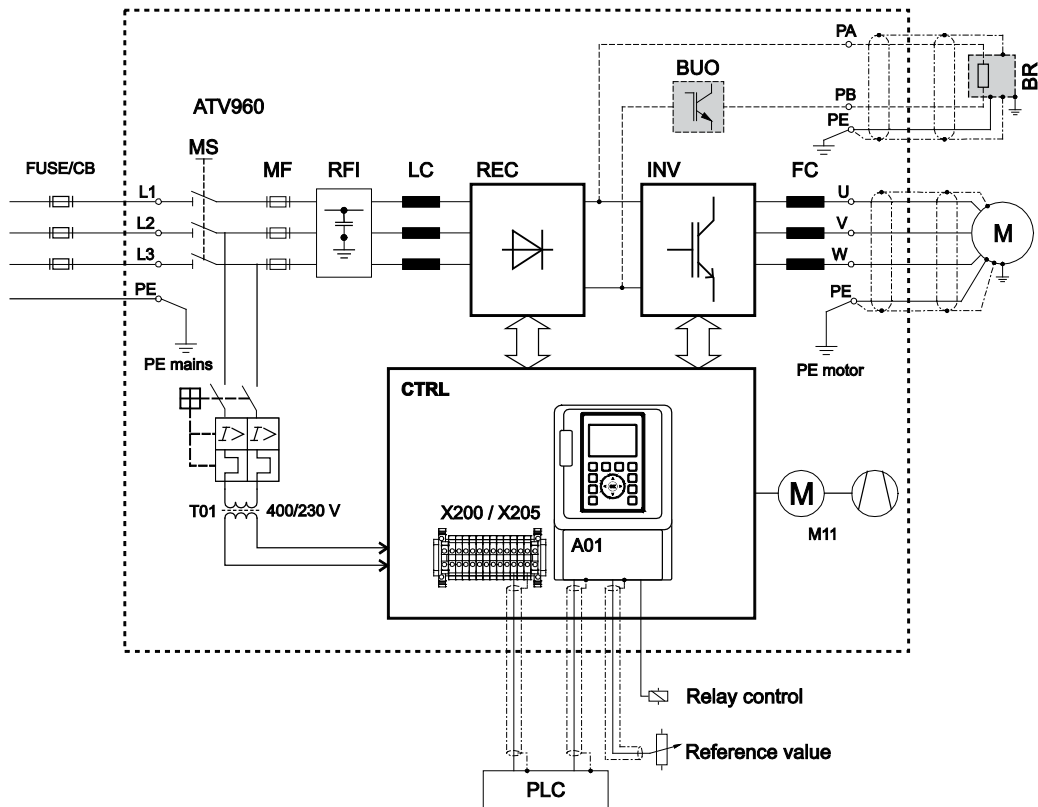

- ATV960** Altivar Process Drive Systems
- FUSE/CB** External pre-fuse or circuit breaker to protect the mains cable
- MS** Built-in main switch, lockable in open position
- T01** Control transformer 400 / 230 V AC
- MF** aR fuses for short-circuit shut-down if the electronic protective devices do not work properly
- RFI** Built-in RFI filter
considering category C3 according to EN 61800-3 "Use in industrial environments"
- LC** Line reactor to reduce the current harmonics on the mains caused by the DC link.
- REC** Rectifier module(s)
- INV** Inverter module(s)
- FC** dv/dt filter choke to reduce the voltage load of the motor
(at some types a "dv/dt filter choke" is already integrated)
- CTRL** Control panel with control block and further control components
- A01** Control terminals at the control block
- X200 / X205** Control terminals at the control panel
- M11** Fan in enclosure door
- BUO** Braking unit option
- BR** Braking resistor (option)



Mains Connection

Dimensioning of the Power Cables

The Altivar Process Drive Systems include semiconductor fuses as standard. These fuses are for the case that the electronic protective mechanisms of the inverter do not work. So they are a secondary protection of the inverter.

The Altivar Process Drive Systems help to protect themselves as well as the mains cables and the motor cables against thermal overload. The specified pre-fuses or circuit breakers (with magnetic release) must be installed upstream to protect the mains cables against short-circuit.

The recommended values for dimensioning the cable cross sections given in chapter "Technical data" are reference values for multi-core copper power cables layed in air at a maximum ambient temperature of 40°C. Observe different ambient conditions and local regulations.

Recommended types of mains cables	
	Three-phase cable with sector-shaped conductors and reduced protective conductor NOTE: Check whether the protective conductor complies with the requirements of IEC 61439-1.
	Three-phase cable with round conductors and reduced protective conductor. NOTE: Check whether the protective conductor complies with the requirements of IEC 61439-1.

NOTE: The recommended cable cross sections are given at the technical data of the respective Altivar Process Drive System (from page 38).

WARNING

OVERLOAD DUE TO INCORRECT RATING OF MAINS SUPPLY

- Install properly rated upstream mains fuses or circuit breakers.
- When rating the upstream mains fuses and the cross sections as well as the length of the mains cables, take into account the available specified short circuit current.
- If the required short circuit is not available, increase the power of the transformer.

Failure to follow these instructions can result in death, serious injury, or equipment damage.

Overcurrent- and Short-circuit Protection

The following picture illustrates the overcurrent protection and short-circuit protection at the input side.

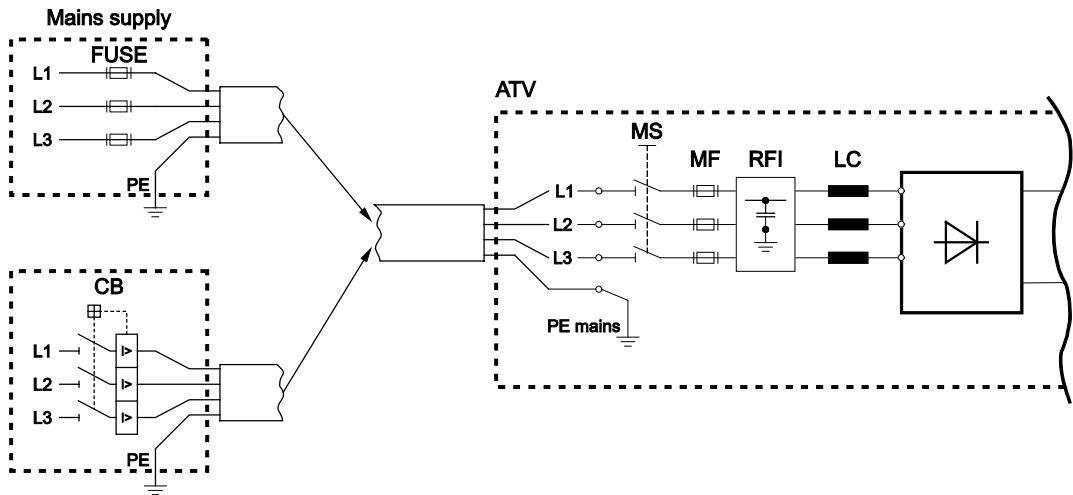

- ATV** Altivar Process Drive Systems
- FUSE** External pre-fuse to protect the mains cable
- CB** External circuit breaker to protect the mains cable (alternatively to FUSE)
- MS** Built-in main switch, lockable in open position
- MF** aR mains fuses for short-circuit shut-down if the electronic protective devices do not work properly
- RFI** Built-in RFI filter considering category C3 according to EN 61800-3 "Use in industrial environments"
- LC** Line reactor to reduce the current harmonics on the mains caused by the DC link.
- REC** Rectifier module(s)

The Altivar Process Drive System includes semiconductor fuses as standard. These fuses are for the case that the electronic protective mechanisms of the inverter do not work. So they are a secondary protection of the inverter.

NOTE: If the mains fuses blow, the inverter already has a primary damage. Therefore, exchanging the blown fuses and switching the inverter on again without any check is not effective.

NOTE: The overcurrent protection is given at the technical data of the respective Altivar Process Drive System (from page 38).

Mains Current Harmonics / Mains Voltage Distortion

Because of using a diode rectifier on the input of a conventional inverter, harmonics occur in the mains current which lead to a voltage distortion of the supplying mains.

All ATV960 High Performance Drive Systems are equipped with line reactors to reduce the current harmonics. They are dimensioned in such a way that already at 80 % load a THD(i) < 48 % is kept. Details see table below.

Power [kW]	I _{sc} [kA]	I _n [A]	H1 [A]	Harmonics at nominal load [%]																
				H5	H7	H11	H13	H17	H19	H23	H25	H29	H31	H35	H37	H41	H43	H47	H49	THDi
ND:110	22	195	179	36.2	13.8	6.67	3.26	2.91	1.76	1.52	1.18	0.86	0.81	0.53	0.55	0.38	0.38	0.31	0.27	43.3
HD:90	22	164	148	38.7	16.5	6.80	3.63	3.06	1.77	1.69	1.17	1.01	0.84	0.64	0.61	0.42	0.44	0.31	0.32	47.8
ND:132	35	232	214	35.5	13.0	6.57	3.18	2.83	1.77	1.44	1.17	0.80	0.78	0.51	0.52	0.38	0.35	0.31	0.26	42.2
HD:110	35	197	179	37.8	15.4	6.72	3.45	2.99	1.76	1.62	1.17	0.95	0.83	0.59	0.59	0.40	0.41	0.30	0.30	46.1
ND:160	35	277	258	33.3	10.9	6.30	3.07	2.57	1.79	1.22	1.12	0.68	0.68	0.48	0.43	0.38	0.32	0.30	0.26	38.6
HD:132	35	232	214	35.5	13.0	6.57	3.18	2.83	1.77	1.44	1.17	0.80	0.78	0.51	0.52	0.38	0.35	0.31	0.26	42.2
ND:200	35	349	320	36.7	14.3	6.73	3.33	2.96	1.77	1.57	1.18	0.90	0.82	0.55	0.57	0.38	0.39	0.30	0.28	44.1
HD:160	35	286	257	39.6	16.7	6.74	3.61	3.06	1.77	1.71	1.16	1.01	0.84	0.65	0.61	0.44	0.45	0.32	0.33	47.9
ND:250	50	432	398	35.3	12.9	6.58	3.18	2.83	1.78	1.44	1.17	0.80	0.78	0.50	0.52	0.38	0.35	0.31	0.27	41.9
HD:200	50	353	319	38.2	15.9	6.77	3.52	3.03	1.76	1.65	1.17	0.98	0.83	0.61	0.60	0.41	0.43	0.31	0.31	46.8
ND:315	50	538	504	32.6	10.4	6.23	3.07	2.49	1.79	1.17	1.09	0.66	0.65	0.48	0.42	0.38	0.32	0.29	0.26	37.6
HD:250	50	432	398	35.3	12.9	6.58	3.18	2.83	1.78	1.44	1.17	0.80	0.78	0.50	0.52	0.38	0.35	0.31	0.27	41.9
ND:355	50	611	566	34.4	11.9	6.52	3.12	2.75	1.79	1.37	1.16	0.75	0.75	0.49	0.48	0.38	0.33	0.31	0.26	40.4
HD:280	50	489	445	37.4	15.0	6.76	3.42	3.00	1.76	1.62	1.18	0.94	0.83	0.58	0.59	0.40	0.42	0.30	0.30	45.3
ND:400	50	681	636	33.0	10.7	6.34	3.07	2.58	1.80	1.23	1.12	0.68	0.69	0.48	0.43	0.38	0.32	0.30	0.27	38.3
HD:315	50	545	501	35.9	13.4	6.67	3.23	2.90	1.77	1.51	1.18	0.85	0.80	0.52	0.54	0.38	0.37	0.31	0.27	42.8
ND:450	50	764	718	31.7	9.64	6.11	3.07	2.38	1.79	1.09	1.05	0.64	0.61	0.48	0.40	0.38	0.32	0.28	0.26	36.3
HD:355	50	611	566	34.4	11.9	6.52	3.12	2.75	1.79	1.37	1.16	0.75	0.75	0.49	0.48	0.38	0.33	0.31	0.26	40.4
ND:500	50	846	800	30.5	8.84	5.86	3.09	2.18	1.75	0.99	0.97	0.63	0.55	0.48	0.39	0.35	0.32	0.25	0.24	34.6
HD:400	50	681	636	33.0	10.7	6.34	3.07	2.58	1.80	1.23	1.12	0.68	0.69	0.48	0.43	0.38	0.32	0.30	0.27	38.3
ND:560	50	948	893	31.2	9.33	6.06	3.08	2.33	1.78	1.06	1.04	0.64	0.60	0.49	0.40	0.37	0.32	0.27	0.25	35.6
HD:450	50	767	714	33.7	11.3	6.48	3.10	2.69	1.80	1.32	1.15	0.73	0.73	0.49	0.47	0.39	0.33	0.31	0.26	39.3
ND:630	50	1058	1002	30.0	8.56	5.78	3.10	2.11	1.73	0.96	0.95	0.63	0.54	0.48	0.39	0.34	0.31	0.24	0.24	33.9
HD:500	50	849	795	32.5	10.3	6.30	3.08	2.53	1.80	1.19	1.11	0.67	0.67	0.49	0.43	0.38	0.32	0.29	0.26	37.5
ND:710	50	1192	1129	30.0	8.56	5.82	3.11	2.13	1.74	0.97	0.95	0.64	0.55	0.48	0.39	0.34	0.31	0.24	0.24	33.9
HD:560	50	951	890	32.5	10.4	6.34	3.09	2.56	1.80	1.21	1.12	0.68	0.68	0.49	0.44	0.39	0.32	0.30	0.26	37.6
ND:800	50	1335	1270	28.7	7.95	5.50	3.13	1.91	1.67	0.90	0.86	0.64	0.51	0.46	0.39	0.31	0.30	0.23	0.22	32.3
HD:630	50	1061	999	31.3	9.39	6.11	3.09	2.36	1.79	1.08	1.05	0.64	0.61	0.49	0.40	0.37	0.32	0.27	0.26	35.8

NOTE: The actual values for the respective mains situation can be calculated on request.

NOTE: Alternatively to the reduction of the current harmonics with line reactors, you can order the product range ATV980 – Regenerative Drive Systems. It contains an active mains supply module, reaches a THDi ≤ 5 % and so it fulfills the requirements according IEEE 519.

Motor Connection

Assignment of the Motor

All Altivar Process Drive Systems include the function "Dual rating". It enables the use for drives with low overload "Normal duty" (typically pumps and fans) and, on the other hand, also the use with increased requirements regarding overload capability, starting torque, load impacts and control performance "Heavy duty" (e.g. compressors, mixers, rotary blowers,...).

You can select the desired power/overload capability with parameter [Dual rating] drL . When changing this parameter all relevant parameters are adapted to the selected property. For example, the parameters for motor power and motor current are modified accordingly.

In case of setting HD – Heavy Duty [High rating] $HiGH$ the overload capability and the maximum overload current are increased. But at the same time the nominal motor power and the continuous output current of the frequency inverter are reduced. So you have to select a higher device type for the same motor power.

Example for ATV960C13Q4X1:

Normal Duty ND:

132 kW with 250 A
continuous current and 300 A
overload current for 60 s

- Nominal power
- Overload 20 %
- Factory setting:
[Normal rating] $norMAL$

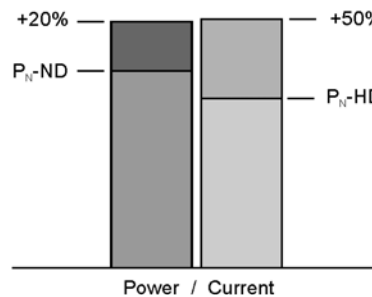

Heavy Duty HD:

110 kW with 211 A
continuous current and 317 A
overload current for 60 s

- Lower nominal power
- Overload 50 %
- Selectable via parameter:
[High rating] $HiGH$

The factory setting of the parameter [Dual Rating] drL is "Normal Duty". When the product is reset to the factory settings, this parameter is also reset to "Normal Duty".

Dimensioning of the Motor Cables

The recommended values for dimensioning the cable cross sections given in chapter "Technical data" are reference values for multi-core copper power cables layed in air at a maximum ambient temperature of 40°C. Observe different ambient conditions and local regulations.

NOTE: The recommended cable cross sections are given at the technical data of the respective Altivar Process Drive System (from page 38).

The motor cables are dimensioned for the maximum continuous current. They apply to 0...100 Hz (up to 300 Hz the cable losses increase about 25 % because of the Skin-effect).

The IGBT modules cause high-frequent interferences which drain off more and more stronger to the ground potential with increasing motor cable length. As a result the line-conducted interferences to the mains increase. In case of too long motor cables the attenuation of the mains filters is not longer sufficient and the permitted interference limits are exceeded.

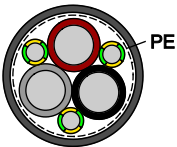
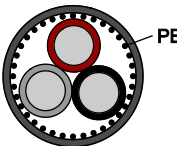
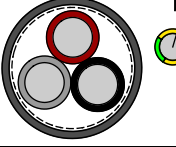
Recommended types of motor cables	
	<p>Symmetrically shielded cable with three phase conductors, symmetrically arranged PE conductor and a shield.</p> <p>NOTE: Check that the PE conductor complies with the requirements according to IEC 61439-1.</p> <p>Example: 2YSLCY-JB</p>
	<p>Symmetrically shielded cable with three phase conductors and a concentric PE conductor as shield.</p> <p>NOTE: Check that the shield (PE conductor) complies with the requirements according to IEC 61439-1.</p> <p>Example: NYCY / NYCWY</p>
	<p>Symmetrically shielded cable with three phase conductors.</p> <p>NOTE: A separate PE conductor is required if the shield does not fulfill the requirements according to IEC 61439-1.</p>

NOTE: Shielded single-conductor cables are not recommended due to increased currents in the shield.

DANGER

ELECTRIC SHOCK DUE TO OVERLOAD ON MOTOR CABLES

- Verify that the protective conductor complies with the requirements of the standard IEC 61439-1.
- Observe the recommendations for motor power cables described in the standard IEC 60034-25.

Failure to follow these instructions will result in death or serious injury.

Length of Motor Cables

Because of the permitted mains disturbances, the allowed overvoltages at the motor, the occurring bearing currents and the permitted heat losses the distance between inverter and motor(s) is limited. The maximum distance heavily depends on the used motors (insulation material), the type of motor cable used (shielded/unshielded), the cable laying (cable channel, underground installation, ...) as well as from the used options.

Dynamic voltage load of the motor

Overvoltages at the motor terminals result from reflection in the motor cable. Basically the motors are stressed with measurable higher voltage peaks from a motor cable length of 10 m. With the length of the motor cable also the value of overvoltage increases.

The steep edges of the switching impulses at the output side of the frequency inverter lead to a further load of the motors. The slew rate of the voltage is typically over 5 kV/μs but it decreases with the length of the motor cable.

The ATV960 frequency inverters are equipped with a dv/dt filter choke (at higher types a "dv/dt filter choke" is already integrated), which significantly reduces the load of the motors and so it is in accordance with the allowed limits.

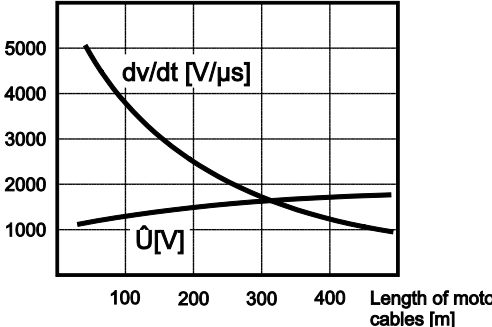
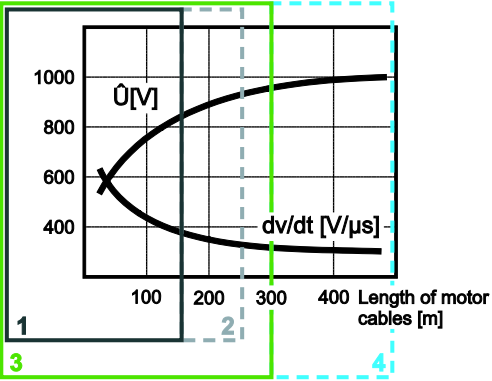
Typical load of the motor ⁽¹⁾	Description
	<p>Load of the motor with overvoltage and slew rate when using conventional frequency inverters without integrated dv/dt filter chokes.</p>
	<p>Reduced load of the motor by using Altivar Process Drive Systems with integrated dv/dt filter chokes 150 m (at higher types a "dv/dt filter choke" is already integrated).</p> <ol style="list-style-type: none"> 1 When using a shielded motor cable 2 When using an unshielded motor cable 3 When using a shielded motor cable and a "dv/dt filter choke 300 m". 4 When using an unshielded motor cable and a "dv/dt filter choke 300 m".
<p>(1) The given values are related to the voltage load phase-to-phase. The voltage values phase to ground are approximately 300 V lower, du/dt is approximately 150 V/μs lower.</p>	

The motor standards for IEC and NEMA specify limits for the permitted load regarding slew rate and voltage peaks.

- IEC 60034-17 – Permitted values for standard power supply driven motors at the frequency inverter, up to 500 V
- IEC 60034-25 – Permitted values for "inverter motors" up to 500 V
- NEMA MG1 – Permitted values for "inverter motors"

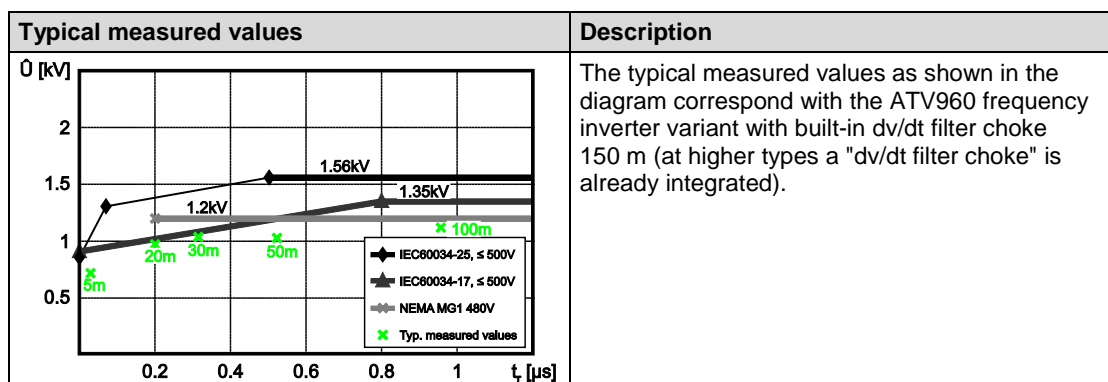

Motors according IEC 60034-25 as well as motors according NEMA MG1 are dimensioned for operation with frequency inverters and thus they are well qualified for drives with ATV960 frequency inverters.

Motors according IEC 60034-17 are dimensioned for operation with pure sinusoidal voltage, but they can also be operated at ATV960 when observing the permitted cable lengths and correct customization.

The Low Harmonic Drive Systems ATV680 and ATV980 offer significant improvement regarding motor load in comparison with older generations with active mains rectifiers AFE (as still offered from many competitors). By the new "3-level" system architecture the voltage load is the same as for ATV660 and ATV960 with classic diode rectifiers and so it not required to take it into account separately.

Basically for all motors from frame size 315 (approximately 110 kW) an insulated bearing on the non-drive end is recommended. It helps to prevent internal current flow inside the motor which can result from unbalances. The insulated bearing is to be understood as supplement to the dv/dt filter choke inside the frequency inverter.

NOTICE

OVERVOLTAGE AT THE MOTOR

Do not exceed the maximum length of the motor cables as specified in this document.

Failure to follow these instructions can result in equipment damage.

EMC interferences

The IGBT modules cause high-frequent interferences which drain off more and more stronger to the ground potential with increasing motor cable length. As a result the line-conducted interferences to the mains increase. In case of too long motor cables the attenuation of the mains filters is not longer sufficient and the permitted interference limits are exceeded.

The IGBT modules cause high-frequency interference which increases with increasing motor cable length. If the motor cable length exceeds the maximum cable length, the internal mains filters are no longer sufficient.

WARNING

UNEXPECTED EQUIPMENT OPERATION DUE TO HIGH-FREQUENCY INTERFERENCE

Do not exceed the maximum length of the motor cables as specified in this document.

Failure to follow these instructions can result in death, serious injury, or equipment damage.

This product meets the EMC requirements according to the standard IEC 61800-3 if the measures described in this manual are implemented during installation.

If the selected composition (product itself, mains filter, other accessories and measures) does not meet the requirements of category C1, the following information applies as it appears in IEC 61800-3:

WARNING

RADIO INTERFERENCE

In a domestic environment this product may cause radio interference in which case supplementary mitigation measures may be required.

Failure to follow these instructions can result in death, serious injury, or equipment damage.

Bearing currents

The dv/dt filter choke inside the ATV960 frequency inverter effects a significant reduction of the common mode bearing currents.

Especially in case of big motors with middle up to high motor cable lengths the filter chokes are considerable to increase the availability of the motor.

Multiplication factors

In case of conditions differing from the table the recommended cable lengths have to be converted by means of the following factors.

If several factors apply, please multiply them.

		Correction of the max. cable lengths
The pulse frequency does not correspond to factory setting:	at 4 kHz	multiply all values by 0.70
	at 8 kHz	multiply all values by 0.40
Output frequencies higher than 100 Hz.	up to 200 Hz	multiply all values by 0.80
	up to 300 Hz	multiply all values by 0.50
In case of 6-pole motor cabling (e.g. for star/delta starting circuit)		multiply all values by 0.75
In case of parallel motors with a dedicated cable to each motor the inverter values have to be converted in compliance with the number of motors. When a motor choke is used for each motor, the following values in brackets apply.	at 2 motors	multiply all values by 0.40 (0.80)
	at 3 motors	multiply all values by 0.25 (0.60)
	at 4 motors	multiply all values by 0.15 (0.40)
	at 5 motors	multiply all values by 0.10 (0.25)
In case of parallel motors with a common cable to all motors the inverter values have to be converted in compliance with the number of motors:	at 2 motors	multiply all values by 0.80
	at 3 motors	multiply all values by 0.60
	at 4 motors	multiply all values by 0.40
	at 5 motors	multiply all values by 0.25

Recommended maximum lengths of motor cables in second environment (industrial environment)

EMC category (EN 61800-3)	ATV960	Customization	Type of cable	Max. cable length
C3	C11●4X1...C31●4X1	–	Shielded	50 m
	C11●4X1...C31●4X1	dv/dt filter choke 150m	Shielded	150 m
	C35●4X1...C80●4X1	– ⁽¹⁾	Shielded	150 m
C4	C11●4X1...C31●4X1	–	Unshielded	100 m
	C11●4X1...C31●4X1	dv/dt filter choke 150m	Unshielded	250 m
	C35●4X1...C80●4X1	– ⁽¹⁾	Unshielded	250 m
	C11●4X1...C80●4X1	dv/dt filter choke 300m	Shielded	300 m
	C11●4X1...C80●4X1	dv/dt filter choke 300m	Unshielded	500 m
(1) At ATV960 Drive Systems from 355 kW the dv/dt filter choke 150m is built-in as standard.				

NOTE: The specified lengths of motor cables are recommended limits based on typical motor cables, laying in cable channels, default pulse frequency and maximal output frequency of 100 Hz. Longer cable lengths are possible on request.

Thermal Motor Monitoring

In the Altivar Process Drive System several possibilities for thermal motor monitoring are available:

- Standard sensor inputs AI1, AI3 at the control block
Suitable temperature sensors: PTC, Pt100, Pt1000, KTY84
- Sensor inputs AI4, AI5 at expansion card "Logic and analog I/O card"
Suitable temperature sensors: PTC, Pt100, Pt1000, KTY84

DANGER

HAZARD OF ELECTRIC SHOCK, EXPLOSION OR ARC FLASH

- Verify that the temperature sensors in the motor meet the PELV requirements.
- Verify that the motor encoder meets the PELV requirements.
- Verify that any other equipment connected via signal cables meets the PELV requirements.

Failure to follow these instructions will result in death or serious injury.

- On customer request the motor monitoring PTC, a PTC thermistor relay (alternatively with ATEX certificate), is installed and the sensor inputs are wired with the option terminals. The evaluation is performed via the diagnostics system in the Altivar Process Drive System.
- On customer request the motor/bearing monitoring Pt100/Pt1000/KTY is installed, which includes evaluation relays and the wiring of the sensor inputs to the option terminals. The evaluation is performed via the diagnostics system in the Altivar Process Drive System.

NOTE: When protective separation of the thermistor sensors in the motor cannot be guaranteed or in case of long motor cables, this option is highly recommended.

Customizations

Predefined Customizations

Customization	Brief description	Page
Enclosure options		
Increased protection degree IP54	Enclosure designed in increased protection degree IP54	98
Enclosure plinth	Enclosure plinth for basic device in protection degree IP23	99
Connection enclosure	Separate connection enclosure; for connection of cables alternatively from top or from bottom.	99
Enclosure lighting	Fluorescent lamp and a power socket 230 V AC	100
Enclosure heating	Heats the enclosure in order to avoid frost and condensation at an ambient temperature up to -10°C	100
Modified wiring colors	Modified wiring colors at the power cables	101
Control options		
Key switch "local / remote"	Key switch in the enclosure door for switching between remote control and local control	102
Ethernet port on front door	Access to the Ethernet network directly on the enclosure door	102
I/O expansion cards		
Logic and analog I/O card	Expansion card for additional analog and digital inputs and outputs (6 digital inputs, 2 digital outputs, 2 analog inputs)	103
Relay output card	Expansion card with three additional relay outputs	103
Communication cards		
Communication card CANopen Daisy Chain	Option card for control of the inverter via CANopen Daisy Chain	104
Communication card CANopen SUB-D9	Option card for control of the inverter via CANopen with SUB-D port	104
Communication card CANopen with screw terminals	Option card for control of the inverter via CANopen with screw terminals	104
Communication card DeviceNet	Option card for control of the inverter via DeviceNet	104
Communication card Profibus DP	Option card for control of the inverter via Profibus DP V1	104
Communication card PROFINET	Option card for control of the inverter via PROFINET	105
Communication card EtherCAT Daisy Chain	Option card for control of the inverter via EtherCAT Daisy Chain	105
Encoder interfaces		
Digital encoder interface module 5/12 V	Interface module for connecting a digital encoder	106
Analog encoder interface module	Interface module for connecting an analog encoder	106
Resolver interface module	Interface module for connecting a resolver	106
HTL encoder interface module	Interface module for connecting an encoder with push-pull (HTL) output driver	106
Functional safety		
STO - SIL 3 Stop category 0	This option effects a Safe Torque Off at the motor	107
STO - SIL 3 Stop category 1	This option effects a Safe Torque Off at the motor with controlled deceleration	107
Display options		
Front Display Module (FDM)	Measuring device mounted in the enclosure door which indicates the operating data	108
Indicator lamps on front door	Three additional Indicator lamps mounted in the enclosure door which indicate the operating state	108

Customization	Brief description	Page
Motor options		
Motor monitoring PTC	PTC thermistor relay to monitor the motor temperature via PTC thermistors in the motor	109
Motor monitoring PTC with ATEX certificate	PTC thermistor relay to monitor the motor temperature via PTC thermistors in the motor with ATEX certificate	109
Motor monitoring Pt100/Pt1000/KTY	Tripping unit to monitor the motor temperature via Pt100/Pt1000/KTY sensors in the motor winding	109
Bearing monitoring Pt100/Pt1000/KTY	Tripping unit to monitor the motor temperature via Pt100/Pt1000/KTY sensors in the bearings of the motor	110
dv/dt filter choke 150 m	Reduces the slew rate, peak voltage and common mode interferences on the output of the inverter and helps to protect the motor	110
dv/dt filter choke 300 m	Helps to protect the motor winding and motor bearings in case of very long motor cable	110
Motor heating	Includes a motor circuit breaker, a contactor and the terminals to connect a motor heating	110
Mains supply		
Circuit breaker	Mains disconnect unit instead of the main switch, including door handle	111
Undervoltage coil for circuit breaker 230 V	When there is no voltage at the undervoltage coil, the circuit breaker switches off	111
Motor for circuit breaker 230 V	Remote control of the circuit breaker via control commands is possible by means of this motor drive.	112
12-pulse Supply	Contains the components for 12-pulse supply	112
Automated mains disconnect	Autonomous disconnection from the mains in case of a stop request, a detected fault or a safety disconnection via STO.	113
Braking option		
Braking unit option BUO	The braking unit option is used when a quick shut-down of the drive is required.	115
Braking resistor BR	The braking resistor converts the braking energy incurred into heat and thus prevents a further rising of the DC link voltage.	120
Monitoring		
Remote monitoring	Records the data of the Drive Systems and provides them in the Schneider Electric StruxureWare Energy Operation Network.	123
Documentation / Packaging		
Safety labels in local language	With this option the devices can be ordered with labels in the local language.	124
Seaworthy packaging	This option contains a seaworthy packaging for transport by ship.	124

Chapter 4

Wiring of the Control Terminals

What Is in This Chapter?

This chapter contains the following topics:

Topic	Page
Design/Position of the Individual Terminals	80
Control Block	81
Option "Logic and Analog I/O Card"	91
Option "Relay Output Card"	94
Option Terminals	95

Design/Position of the Individual Terminals

The Altivar Process Drive Systems are already equipped with extensive terminals on the control block as standard. The use and the function of all inputs and outputs can be parameterized.

In addition, there are the terminals X200 and X205, which are wired internally appropriate to the customizations.

For expansion the option cards Logic and analog I/O card and the relay output card are available. Both expansion cards can be installed, but the same card cannot be plugged twice.

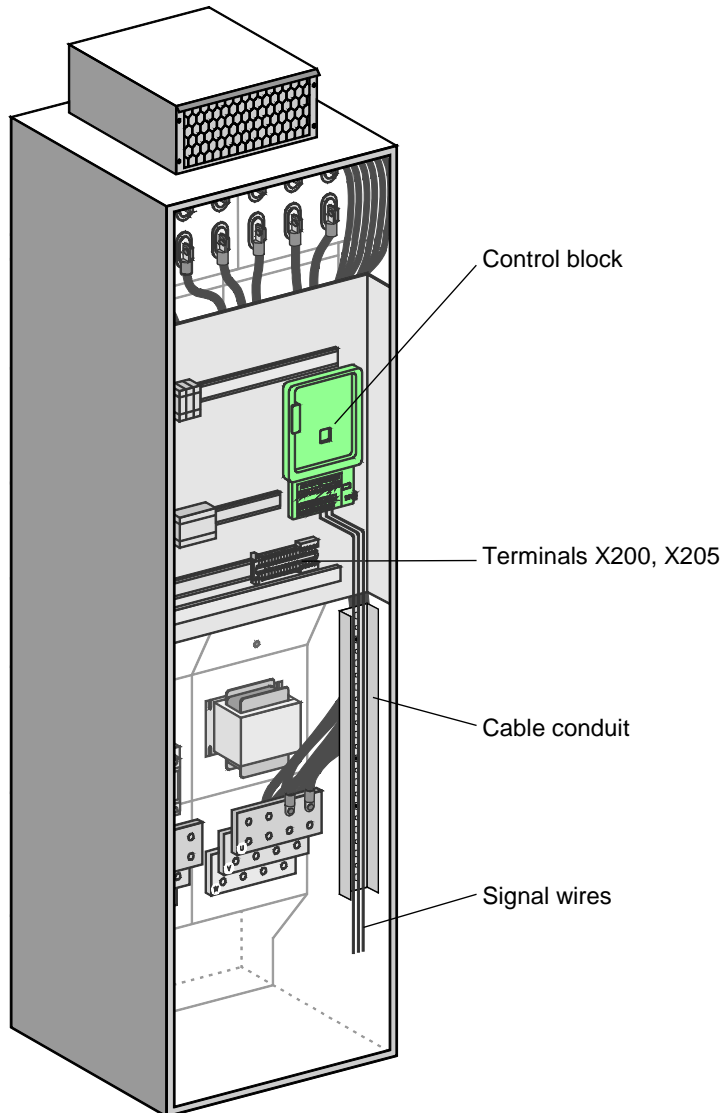

Voltage Supply and Auxiliary Voltage

All Drive Systems are equipped with a control transformer matching with the mains voltage and the required power. It provides a 230 V AC control voltage for supplying the fans in the enclosure doors and the DC supply units.

The DC supply units generate 48 V DC for the internal power part fans and a 24 V DC auxiliary voltage. All control components are supplied by the internally provided voltages.

NOTE: For buffering the control block and with that keeping communication alive (e.g. fieldbus), the control block can be supplied via the terminals P24 and 0V externally with 24 V DC.

Control Block

Structure of the Control Block

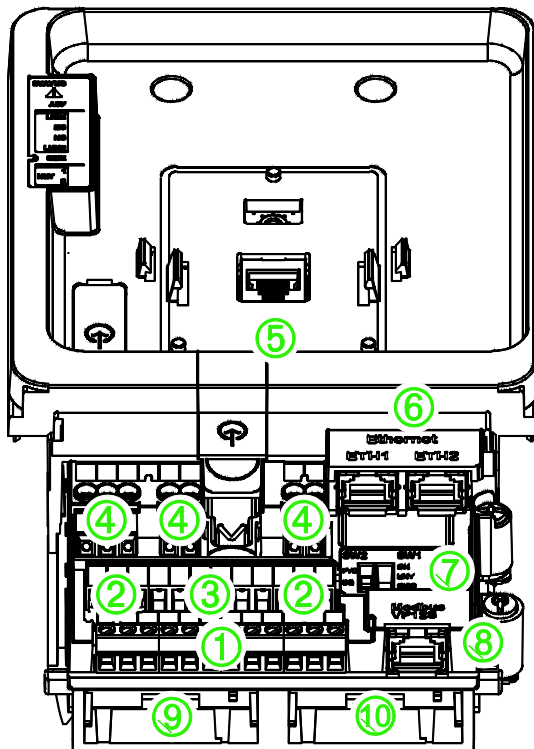

- 1 Control terminals of digital inputs
- 2 Control terminals STO (Safe Torque Off) and analog outputs
- 3 Control terminals of analog inputs
- 4 Control terminals of relay outputs
- 5 RJ45 port for the graphical keypad
- 6 Dual port RJ45 for Ethernet IP or Modbus TCP
- 7 Sink-Ext-Source selector switch and PTO/DQ selector switch
- 8 RJ45 port for serial Modbus
- 9 Slot B for I/O expansion card or encoder interface module
- 10 Slot A for communication card or I/O expansion card

Control Terminals at the Control Block

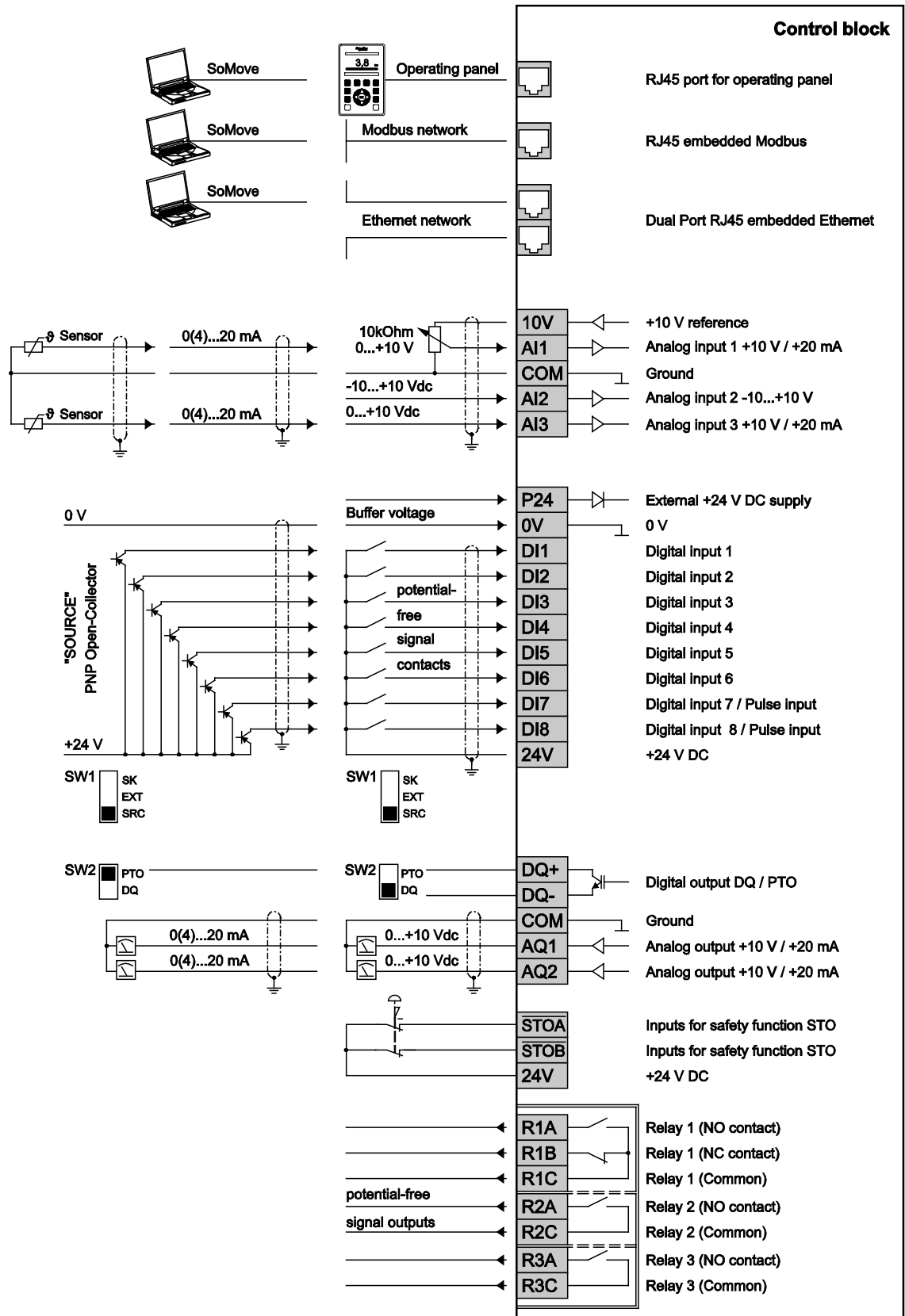

Specification of the Control Terminals

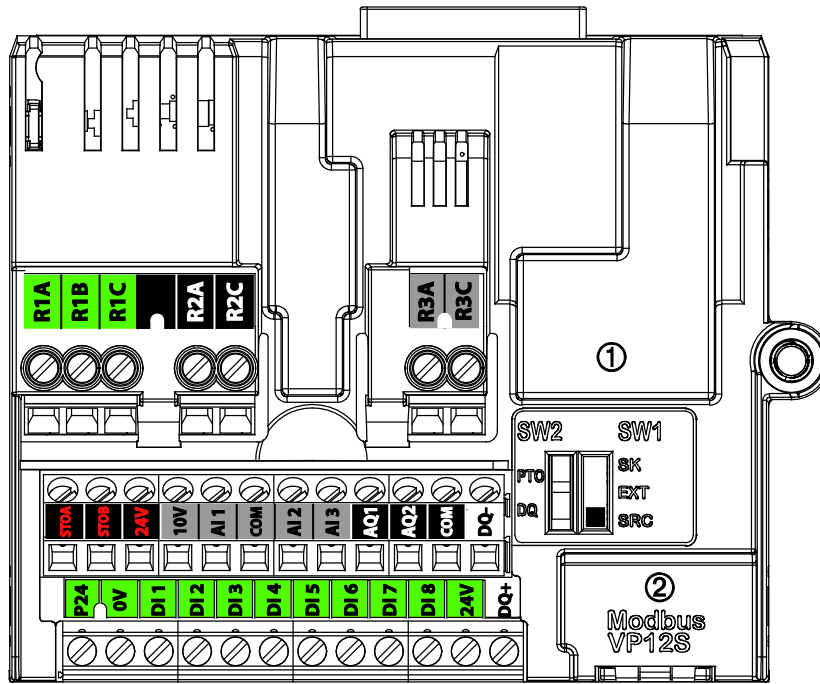

Screw terminals

Maximum cable cross section for all terminals: 1.5 mm² (AWG 16), 0.25 Nm

Minimum cable cross section:

- For relay terminals 0.75 mm²(AWG 18)
- For all other terminals 0.5 mm²(AWG 20)

Strip length: 10 mm

Maximum cable length:

- AI●, AQ●, DI●, DQ●: 50 m shielded
- $\overline{\text{STOA}}$, $\overline{\text{STOB}}$: 30 m

Terminal	Description	Specification
R1A R1B R1C	Relay output 1 (R1A NO contact, R1B NC contact)	<ul style="list-style-type: none"> • Minimum switching capacity: 5 mA for 24 V DC • Maximum switching capacity on resistive load ($\cos \varphi = 1$): 3 A for 250 V AC and 30 V DC • Maximum switching capacity on inductive load ($\cos \varphi = 0.4$ and $L/R = 7$ ms): 2 A for 250 V AC and 30 V DC • Response time: 5 ms \pm 0.5 ms • Life cycle: 100,000 switching cycles at max. switching capacity
R2A R2C	Relay output 2 (NO contact)	<ul style="list-style-type: none"> • Minimum switching capacity: 5 mA for 24 V DC • Maximum switching capacity on resistive load ($\cos \varphi = 1$): 3 A for 250 V AC and 30 V DC • Maximum switching capacity on inductive load ($\cos \varphi = 0.4$ and $L/R = 7$ ms): 2 A for 250 V AC and 30 V DC • Response time: 5 ms \pm 0.5 ms • Life cycle: 100,000 switching cycles at max. switching capacity
R3A R3C	Relay output 3 (NO contact)	<ul style="list-style-type: none"> • Minimum switching capacity: 5 mA for 24 V DC • Maximum switching capacity on resistive load ($\cos \varphi = 1$): 3 A for 250 V AC and 30 V DC • Maximum switching capacity on inductive load ($\cos \varphi = 0.4$ and $L/R = 7$ ms): 2 A for 250 V AC and 30 V DC • Response time: 5 ms \pm 0.5 ms • Life cycle: 100,000 switching cycles at max. switching capacity

Terminal	Description	Specification
$\overline{\text{STOA}}$, $\overline{\text{STOB}}$	STO inputs	Inputs of the safety function STO See "Safety Function Manual (NHA80947)" available on www.schneider-electric.com .
24V	Sampling voltage for STO inputs	+24 V DC for STO inputs $\overline{\text{STOA}}$ and $\overline{\text{STOB}}$
COM	Ground for analog I/O	0 V reference potential for analog outputs
AQ1 AQ2	Analog output AQ1 Analog output AQ2	Analog output configurable for voltage or current by software <ul style="list-style-type: none"> • Analog voltage output 0...10 V DC, min. load impedance 470 Ω • Analog current output freely programmable from 0...20 mA, max. load impedance 500 Ω • Max. sampling period: 10 ms \pm 1 ms • Resolution 10 bits • Accuracy: \pm 1 % for a temperature variation of 60°C • Linearity \pm 0.2 %
DQ+ DQ-	Digital output	Digital output configurable by switch PTO/DQ in position DQ <ul style="list-style-type: none"> • Insulated • Maximum voltage: 30 V DC • Maximum current: 100 mA • Frequency range: 0...1 kHz • Max. sampling period: 2 ms \pm 0.5 ms • Positive/negative logic is realized by wiring
DQ+	Digital output	Pulse train output configurable by switch PTO/DQ in position PTO <ul style="list-style-type: none"> • Open collector not insulated • Maximum voltage: 30 V DC • Maximum current: 20 mA • Frequency range: 0...30 kHz
P24	External input supply	External input supply +24 V DC <ul style="list-style-type: none"> • Tolerance: min. 19 V DC, max. 30 V DC • Current: max. 0.8 A
0V	Weight	0 V for external supply P24
DI1...DI8	Digital inputs	8 programmable digital inputs 24 V DC, comply with IEC/EN 61131-2 logic type 1 <ul style="list-style-type: none"> • Positive logic (Source): state 0 when \leq 5 V DC or digital input not wired, state 1 when \geq 11 V DC • Negative logic (Sink): state 0 when \geq 16 V DC or digital input not wired, state 1 when \leq 10 V DC • Impedance 3.5 kΩ • Maximum voltage: 30 V DC • Max. sampling period: 2 ms \pm 0.5 ms <p>Multiple assignment makes it possible to configure several functions on one input (example: DI1 assigned to forward and preset speed 2, DI3 assigned to reverse and preset speed 3).</p>

Terminal	Description	Specification
DI7...DI8	Pulse inputs	Programmable pulse inputs <ul style="list-style-type: none"> • Comply with level 1 PLC standard IEC 65A-68 • State 0 when ≤ 0.6 V DC, state 1 when ≥ 2.5 V DC • Pulse counter 0...30 kHz • Frequency range: 0...30 kHz • Duty cycle: 50 % \pm 10 % • Maximum input voltage: 30 V DC, < 10 mA • Max. sampling period: 5 ms \pm 1 ms
24V	Sampling voltage for digital inputs	<ul style="list-style-type: none"> • +24 V DC • Tolerance: min. 20.4 V DC, max. 27 V DC • Current: max. 200 mA for both 24 V terminals • Terminal protected against overload and short-circuit • When the selector switch is in position "Ext", this supply is powered by an external PLC.
10V	Sampling voltage for analog inputs	Internal supply for reference potentiometer (1...10 k Ω) <ul style="list-style-type: none"> • 10.5 V DC • Tolerance: \pm 5 % • Current: max. 10 mA • Short-circuit protected
AI1, AI3	Analog inputs and sensor inputs	Three analog input configurable for voltage or current by parameter <ul style="list-style-type: none"> • Analog voltage input 0...10 V DC, impedance 31.5 kΩ • Analog current input freely programmable from 0...20 mA, impedance 250 Ω • Max. sampling period: 1 ms \pm 1 ms • Resolution 12 bits • Accuracy: \pm 0.6 % for a temperature variation of 60°C • Linearity \pm 0.15 % of maximum value
COM	Ground for analog I/O	0 V reference potential for analog outputs

Terminal	Description	Specification
AI2	Analog input	<p>Bipolar voltage input -10...+10 V DC, impedance: 31.5 Ω</p> <ul style="list-style-type: none"> • Max. sampling period: 1 ms ± 1 ms • Resolution 12 bits • Accuracy: ± 0.6 % for a temperature variation of 60°C • Linearity ± 0.15 % of maximum value <p>Pt100, Pt1000, KTY84 or PTC sensor configurable by software</p> <ul style="list-style-type: none"> • Pt100 <ul style="list-style-type: none"> • 1 or 3 temperature sensors per analog input (configurable by software) • Sensor current: 5 mA • Range -20...200°C • Accuracy: ± 4 C for a temperature variation of 60°C • Pt1000, KTY84 <ul style="list-style-type: none"> • 1 (Pt1000, KTY84) or 3 (Pt1000) temperature sensors in series per analog input (configurable by software) • Temperature sensor current: 1 mA • Range -20...200°C • Accuracy: ± 4 C for a temperature variation of 60°C • PTC <ul style="list-style-type: none"> • 1 to 6 sensors in series • Sensor current: 1 mA • Nominal value: < 1.5 kΩ • Overheat trigger threshold: 2.9 kΩ ±0.2 kΩ • Overheat reset threshold: 1.575 kΩ ±0.75 kΩ • Threshold for low impedance detection: 50 kΩ -10 Ω/+20 Ω • Short-circuit detection threshold: < 1 kΩ

 **DANGER**

HAZARD OF ELECTRIC SHOCK, EXPLOSION OR ARC FLASH

- Verify that the temperature sensors in the motor meet the PELV requirements.
- Verify that the motor encoder meets the PELV requirements.
- Verify that any other equipment connected via signal cables meets the PELV requirements.

Failure to follow these instructions will result in death or serious injury.

Signal interference can cause unexpected responses of the drive and of other equipment in the vicinity of the drive.

 **WARNING**

SIGNAL AND EQUIPMENT INTERFERENCE

- Install the wiring in accordance with the EMC requirements described in this document.
- Verify compliance with the EMC requirements described in this document.
- Verify compliance with all EMC regulations and requirements applicable in the country in which the product is to be operated and with all EMC regulations and requirements applicable at the installation site.

Failure to follow these instructions can result in death, serious injury, or equipment damage.

Configuration of the Sink / Source Selector Switch

⚠ WARNING

UNANTICIPATED EQUIPMENT OPERATION

- If the drive is set to "Sink Int" or "Sink Ext", do not connect the "0 V" terminal to ground or to protective ground.
- Verify that accidental grounding of digital inputs configured for sink logic, caused, for example, by damage to the signal cables, cannot occur.
- Follow all applicable standards and directives such as NFPA 79 and EN 60204 for proper control circuit grounding practices.

Failure to follow these instructions can result in death, serious injury or equipment damage.

The switch is used to adapt the operation of the digital inputs to the technology of the signal control. The switch is located below the control terminals (see picture at page 81).

- Set the selector switch to SRC (Source) when using PLC outputs with PNP transistors (factory setting).
- Set the switch to Ext (external) when using PLC outputs with NPN transistors.

Selector Switch in Position SRC (Source) and Internal Voltage Supply of the Digital Inputs

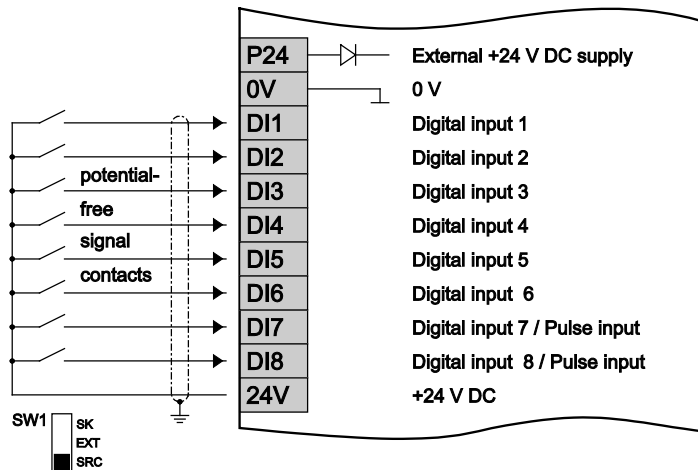

Selector Switch in Position SRC (Source) and External Voltage Supply of the Digital Inputs

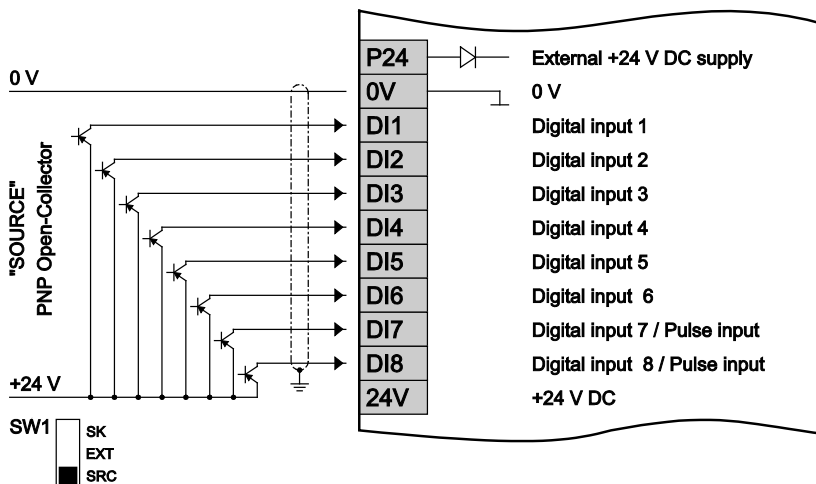

Selector Switch in Position SK (Sink) and Internal Voltage Supply of the Digital Inputs

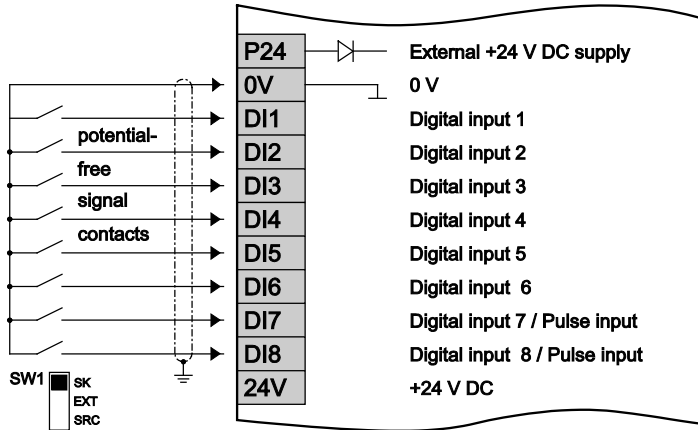

Selector Switch in Position EXT (external) and External Voltage Supply of the Digital Inputs

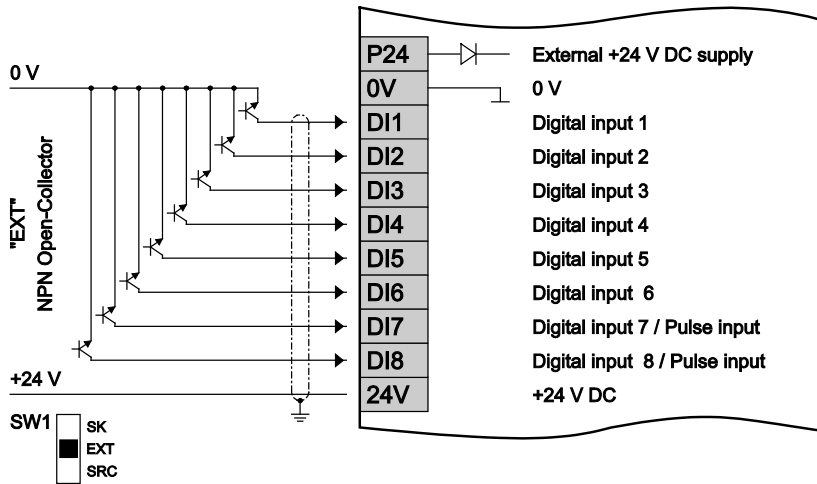

Configuration of the Selector Switch for Pulse Train Outputs / Digital Outputs

⚠ WARNING

UNANTICIPATED EQUIPMENT OPERATION

- If the drive is set to "Sink Int" or "Sink Ext", do not connect the "0 V" terminal to ground or to protective ground.
- Verify that accidental grounding of digital inputs configured for sink logic, caused, for example, by damage to the signal cables, cannot occur.
- Follow all applicable standards and directives such as NFPA 79 and EN 60204 for proper control circuit grounding practices.

Failure to follow these instructions can result in death, serious injury or equipment damage.

The PTO/DQ switch is used to configure the digital outputs DQ+ and DQ-.

- Set the selector switch to PTO (Pulse Train Output) to configure the outputs DQ+ and DQ- as pulse train outputs. This may be used to chain pulse train inputs of another drive, using its pulse inputs DI7 or DI8.
- Set the selector switch to DQ (Digital Output) to configure the outputs DQ+ and DQ- as assignable logic outputs.

The switch is located below the control terminals (see picture at page 81).

Selector Switch in Position SRC (Source) and Internal Voltage Supply of the Digital Inputs

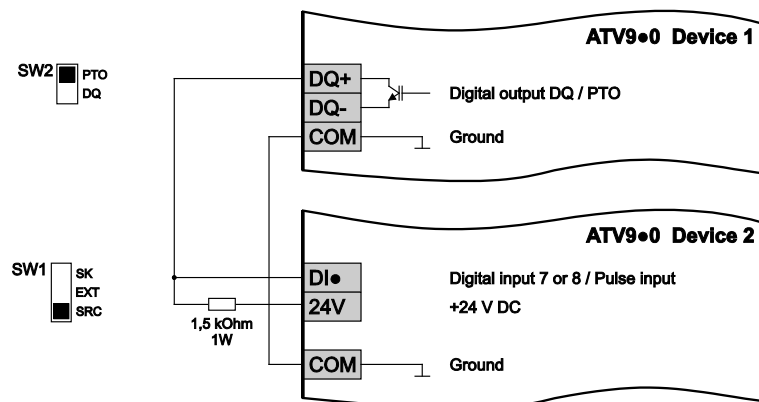

Selector Switch in Position SRC (Source) and External Voltage Supply of the Digital Inputs

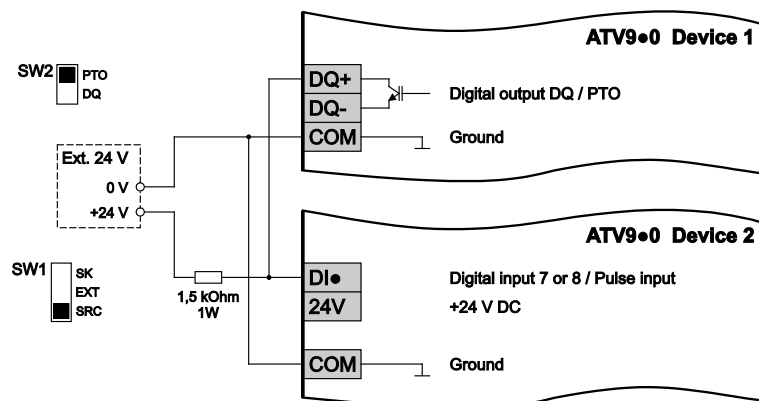

Selector Switch in Position SK (Sink) and Internal Voltage Supply of the Digital Inputs

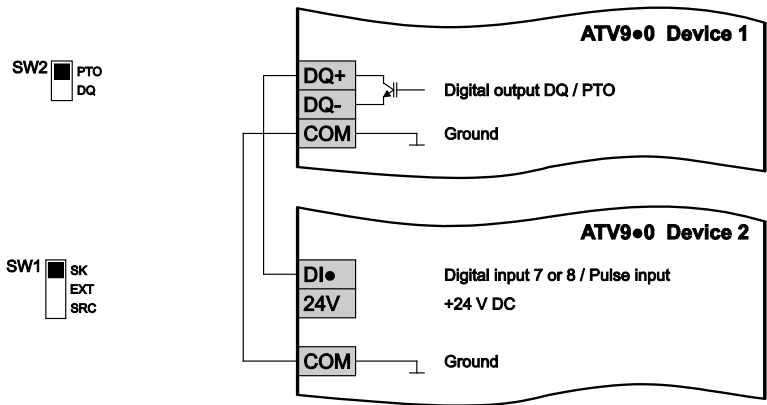

Selector Switch in Position EXT (external) and External Voltage Supply of the Digital Inputs

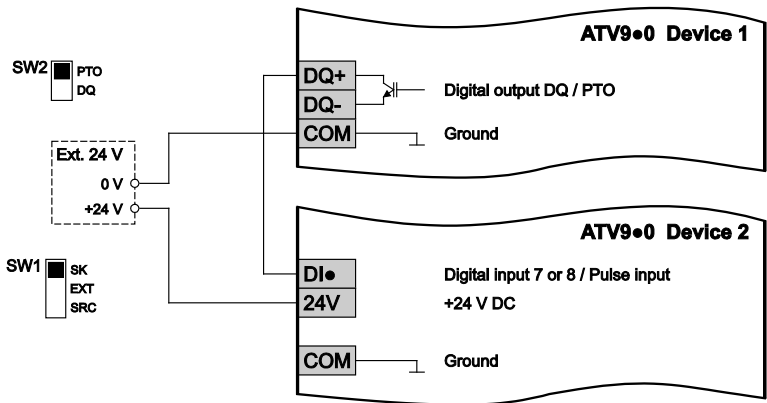

Option "Logic and Analog I/O Card"

Control terminals at the expansion card

Option to expand the control inputs and control outputs of the control block. The expansion card contains two analog inputs, six digital inputs and two digital outputs.

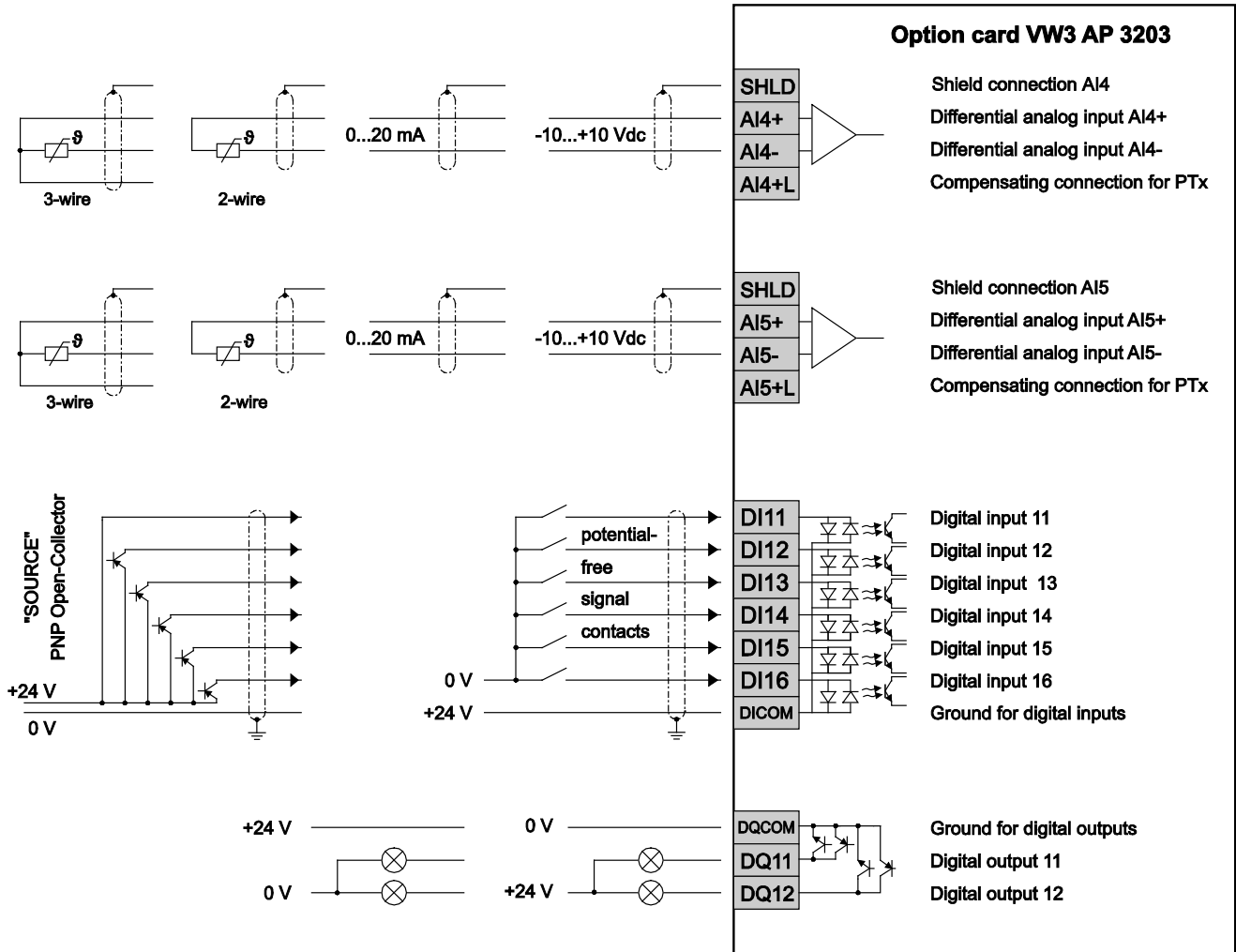

Specification of the Control Terminals

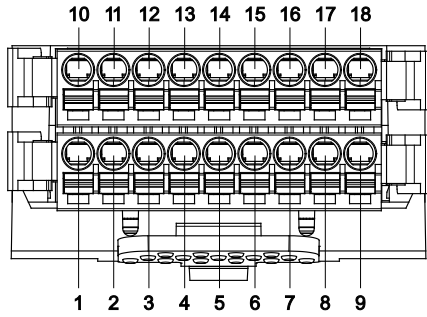

Spring terminals

- Max. cable cross section: 1 mm² (AWG 16)
- Strip length: 10 mm
- Max. cable length AI●, AQ●, DI●, DQ●: 50 m shielded

Pin	Terminal	Description	Specification
1	SHLD	Shield connection for AI4	<p>You can select between voltage, current, Pt100, Pt1000, KTY84 and PTC measurement by software configuration.</p> <p>Differential voltage at the input circuit:</p> <ul style="list-style-type: none"> • Range: -10 V DC...+10 V DC • Impedance: 20 kΩ • Resolution: 11 bits + 1 sign bit • Accuracy: ± 0.6 % for a temperature variation of 60 °C • Linearity ± 0.15 % of maximum value <p>Current measurements:</p> <ul style="list-style-type: none"> • Range: freely programmable from 0...20 mA • Impedance: 250 Ω • Resolution: 12 bits • Accuracy: ± 0.6 % for a temperature variation of 60 °C • Linearity ± 0.15 % of maximum value • Sampling period: 1 ms <p>PTx measurement: Pt100, Pt1000, PTC or KTY84 configurable by software</p> <ul style="list-style-type: none"> • Pt100 <ul style="list-style-type: none"> • 1 or 3 temperature sensors in series per analog input (configurable by software) • Temperature sensor current: max. 7.5 mA • Range -20...200 °C • Accuracy: ± 3°C for a temperature variation of 60 °C • Pt1000, KTY84 <ul style="list-style-type: none"> • 1 (Pt1000, KTY84) or 3 (Pt1000) temperature sensors in series per analog input (configurable by software) • Temperature sensor current: max. 1 mA • Range -20...200 °C • Accuracy: ± 3 °C for a temperature variation of 60 °C • PTC <ul style="list-style-type: none"> • 3 or 6 temperature sensors in series • Temperature sensor current: max. 1 mA • Nominal value: < 1.5 kΩ • Overheat trigger threshold: 2.9 kΩ • Overheat reset threshold: 1.575 kΩ • Short-circuit detection threshold: < 1 kΩ • Wire break detection: > 100 kΩ
2	AI4+	Differential analog input 4 Depending on software configuration: <ul style="list-style-type: none"> • Measurement of differential voltage 	
3	AI4-	<ul style="list-style-type: none"> • PTx measurement • 0...20 mA measurement • Reference potential AI4- for AI4+ 	
4	AI4+L	Compensating connection for one temperature sensor Pt100, Pt1000 or KTY84 in 3-wire-design	
5	SHLD	Shield connection for AI5	
6	AI5+	Differential analog input 5 Depending on software configuration: <ul style="list-style-type: none"> • Measurement of differential voltage 	
7	AI5-	<ul style="list-style-type: none"> • PTx measurement • 0...20 mA measurement • Reference potential AI5- for AI5+ 	
8	AI5+L	Compensating connection for one temperature sensor Pt100, Pt1000 or KTY84 in 3-wire-design	

Pin	Terminal	Description	Specification
9	DQ12	Digital output 12	The 24 V DC digital outputs DQ comply with the standard IEC/EN 61131-2. <ul style="list-style-type: none"> • Logic type selected by DQCOM wiring • Output voltage: ≤ 30 V DC • Switching capability: ≤ 100 mA • Voltage drop at 100 mA load: ≤ 3 V DC • Response time: 1 ms
10	DICOM	Reference potential for the digital inputs	The 24 V DC digital inputs DI are galvanically isolated via optocoupler and comply with the standard IEC/EN 61131-2. <ul style="list-style-type: none"> • Logic type selected by DICOM wiring • Positive logic (Source): state 0 when ≤ 5 V DC, state 1 when ≥ 11 V DC • Negative logic (Sink): state 0 when ≥ 16 V DC, state 1 when ≤ 10 V DC • Maximum voltage: ≤ 30 V DC • Input current (typically): 2.5 mA • Sampling period: 1 ms
11	DI11	Digital input 11	
12	DI12	Digital input 12	
13	DI13	Digital input 13	
14	DI14	Digital input 14	
15	DI15	Digital input 15	
16	DI16	Digital input 16	
17	DQCOM	Reference potential for the digital outputs	The 24 V DC digital outputs DQ comply with the standard IEC/EN 61131-2. <ul style="list-style-type: none"> • Logic type selected by DQCOM wiring • Output voltage: ≤ 30 V DC • Switching capability: ≤ 100 mA • Voltage drop at 100 mA load: ≤ 3 V DC • Response time: 1 ms
18	DQ11	Digital output 11	

DANGER

HAZARD OF ELECTRIC SHOCK, EXPLOSION OR ARC FLASH

- Verify that the temperature sensors in the motor meet the PELV requirements.
- Verify that the motor encoder meets the PELV requirements.
- Verify that any other equipment connected via signal cables meets the PELV requirements.

Failure to follow these instructions will result in death or serious injury.

Signal interference can cause unexpected responses of the drive and of other equipment in the vicinity of the drive.

WARNING

SIGNAL AND EQUIPMENT INTERFERENCE

- Install the wiring in accordance with the EMC requirements described in this document.
- Verify compliance with the EMC requirements described in this document.
- Verify compliance with all EMC regulations and requirements applicable in the country in which the product is to be operated and with all EMC regulations and requirements applicable at the installation site.

Failure to follow these instructions can result in death, serious injury, or equipment damage.

Option "Relay Output Card"

Control terminals at the expansion card

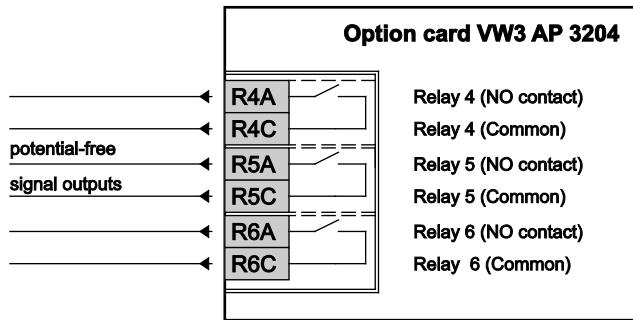

Specification of the Control Terminals

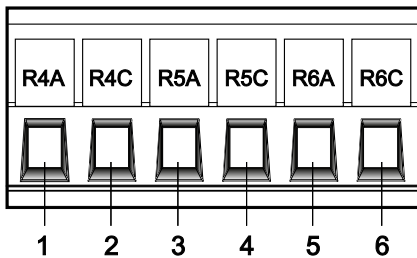

Screw terminals

Maximum cable cross section: 1.5 mm² (AWG 16)
 Maximum tightening torque: 0.5 Nm (4.4 lb.in)
 Minimum cable cross section: 0.75 mm² (AWG 18)
 Strip length: 10 mm

Pin	Terminal	Description	Specification
1	R4A	Relay output 4 (NO contact)	Programmable relay output 4: <ul style="list-style-type: none"> • Minimum switching capacity: 5 mA for 24 V DC • Maximum switching capability on resistive load (cos φ = 1): 3 A for 250 V AC and 30 V DC • Maximum switching capability on inductive load (cos φ = 0.4 and L/R = 7 ms): 2 A for 250 V AC and 30 V DC • Response time: 5 ms ± 0.5 ms • Life cycle: 100,000 switching cycles at max. switching capacity
2	R4C		
3	R5A	Relay output 5 (NO contact)	Programmable relay output 5: <ul style="list-style-type: none"> • Minimum switching capacity: 5 mA for 24 V DC • Maximum switching capability on resistive load (cos φ = 1): 3 A for 250 V AC and 30 V DC • Maximum switching capability on inductive load (cos φ = 0.4 and L/R = 7 ms): 2 A for 250 V AC and 30 V DC • Response time: 5 ms ± 0.5 ms • Life cycle: 100,000 switching cycles at max. switching capacity
4	R5C		
5	R6A	Relay output 6 (NO contact)	Programmable relay output 6: <ul style="list-style-type: none"> • Minimum switching capacity: 5 mA for 24 V DC • Maximum switching capability on resistive load (cos φ = 1): 3 A for 250 V AC and 30 V DC • Maximum switching capability on inductive load (cos φ = 0.4 and L/R = 7 ms): 2 A for 250 V AC and 30 V DC • Response time: 5 ms ± 0.5 ms • Life cycle: 100,000 switching cycles at max. switching capacity
6	R6C		

Option Terminals

Control Terminals at the Option Terminals

The option terminals X200 and X205 are built-in at each Altivar Process Drive System as standard. They are designed as pluggable terminals.

Spring terminals pluggable

Max. cable cross section: 2.5 mm² [AWG 12]
Min. cable cross section: 0.25 mm² [AWG 26]
Strip length: 10 mm

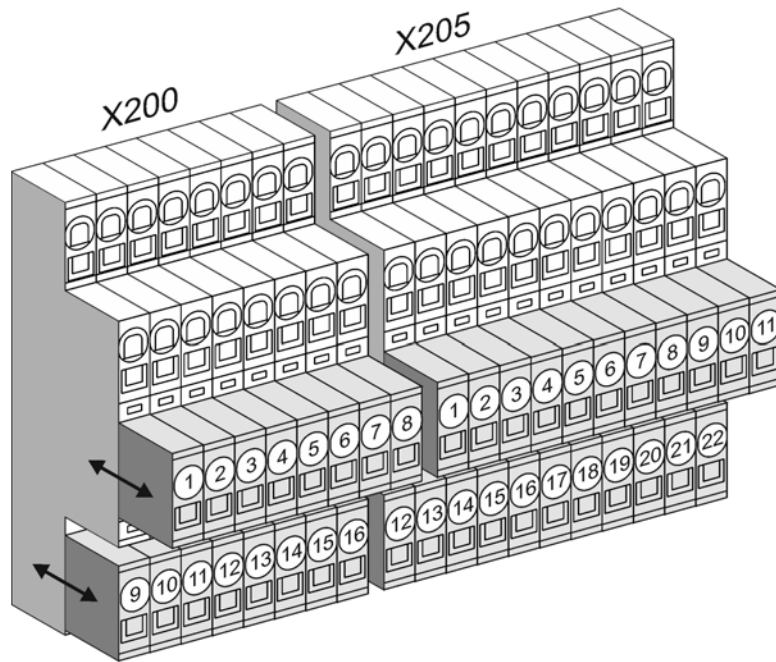

Specification of the Control Terminals

As shown in the following illustration, there are following connections available for the customer depending on the chosen options.

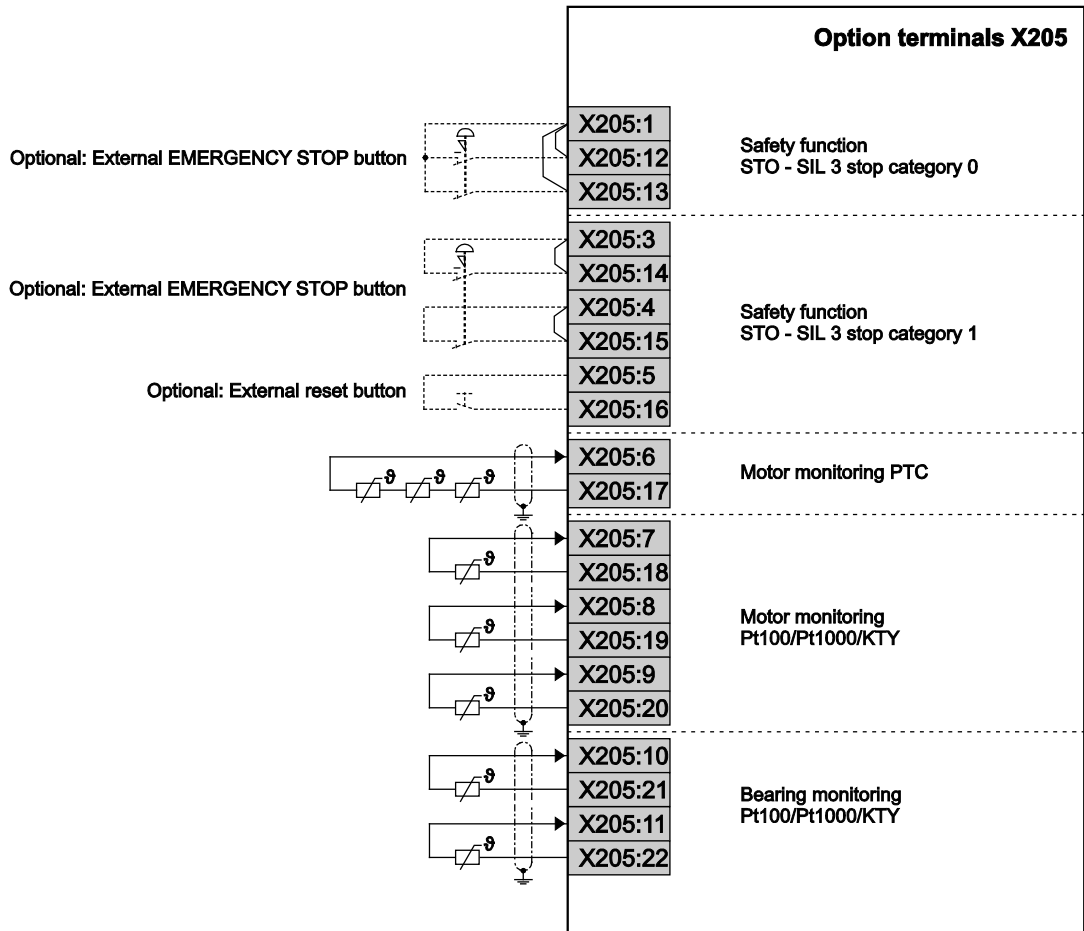
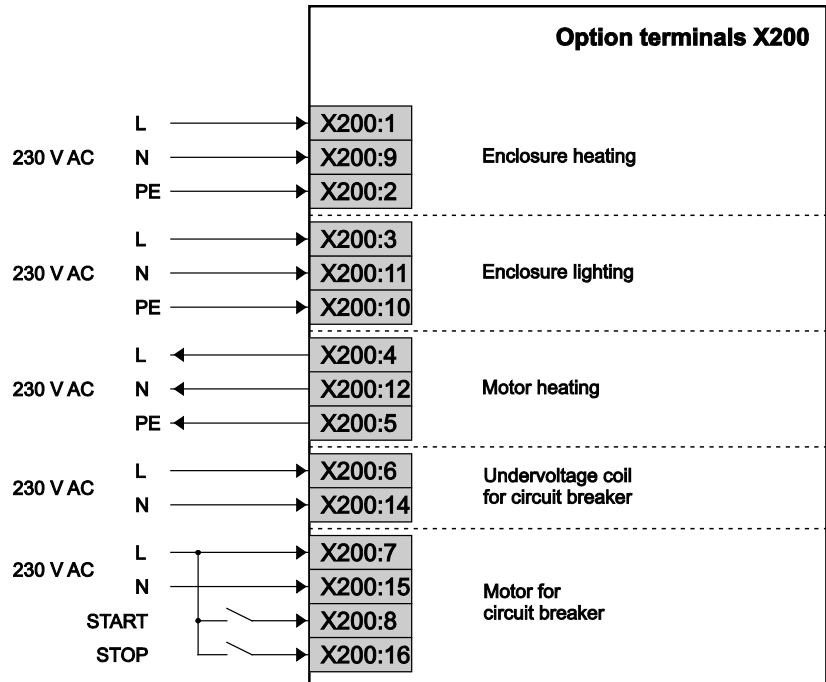

Chapter 5

Customizations

What Is in This Chapter?

This chapter contains the following topics:

Topic	Page
Enclosure Options	98
Control Options	102
I/O Expansion Cards	103
Communication Cards	104
Encoder Interface Modules	106
Functional Safety	107
Display Options	108
Motor Options	109
Mains Supply	111
Braking Option	115
Monitoring Options	123
Packaging	124

Enclosure Options

During manufacturing of the Altivar Process Drive Systems already all customizations are considered. In addition, parameter adjustments are carried out and permanently stored as factory setting, if required.

This chapter contains customizations, which we have already predefined as a result of our many years of experience in order to cover the essential requirements of our customers. But in many cases a unique system solution is necessary due to the variety of applications and requirements.

Your Drive Systems Tendering Team is looking forward to your specific request.

Increased Protection Degree IP54

For operation with rough ambient conditions the enclosure can be designed in protection degree IP54. So when the doors are closed the Altivar Process Drive System is protected against:

- Touching live electrical parts
- Harmful dust accumulation inside
- Penetration of spray water from all directions

Typically, IP54 enclosure units are installed production halls and manufacturing sites, where heavy dirt accumulation is expected.

Our solution contains a clearly specified and tested cooling system with a separate cooling air channel which provides highest reliability.

Via this separated cooling air channel about 90 % of the heat losses are exhausted. The interior of the enclosure is cooled via fans in the enclosure door.

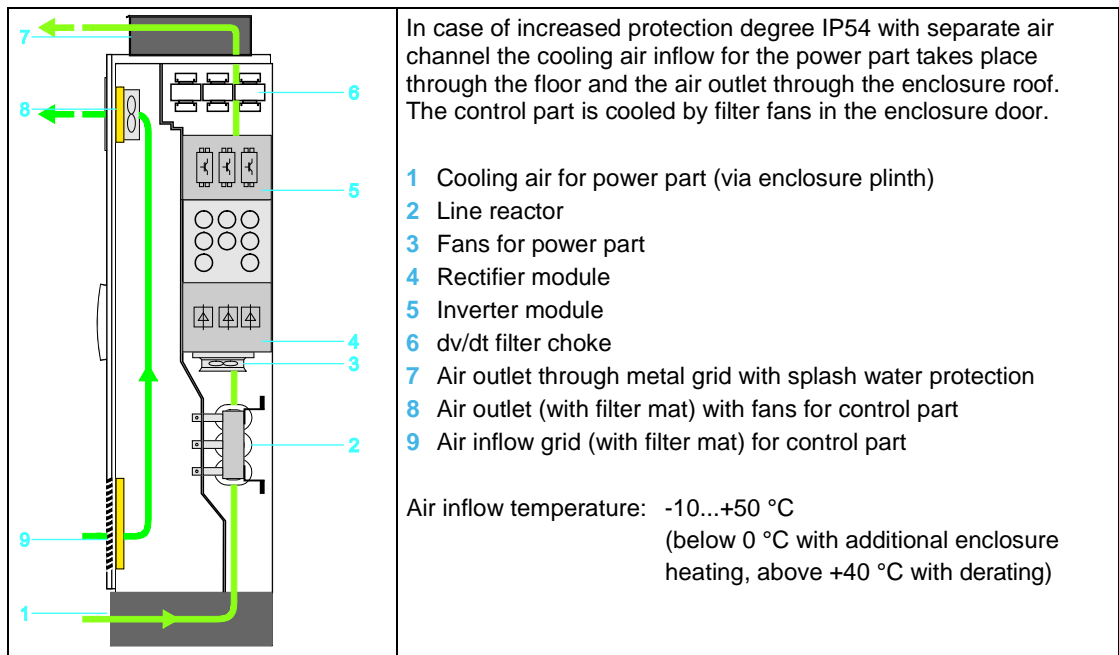

NOTE: The additional enclosure plinth increases the enclosure by 200 mm to a total height of 2350 mm.

Enclosure Plinth for Basic Device

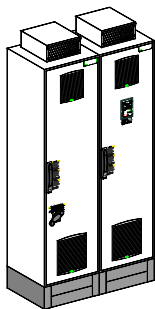

For adapting to the local conditions or for better protection of the enclosure against wet soil, the enclosure can be raised with a plinth (color: RAL 7022) by 200 mm.

So the enclosure height is increased to a total height of 2350 mm.

NOTE: At the customization "Increased protection degree IP54" the enclosure is already equipped with an enclosure plinth as standard.

Connection Enclosure Cable from Top

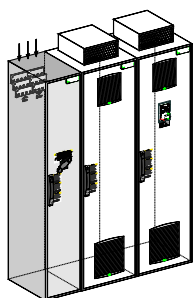

This separate connection enclosure makes it possible to insert and connect the mains cables and motor cables from the top of the enclosure.

The separated connecting enclosure contains all power terminals and the mains disconnection (e.g. main switch), which makes a voltage disconnection of the basic device during maintenance possible.

Furthermore, the connecting enclosure provides enough space for additional customizations.

NOTE: The additional connecting enclosure increases the total width of the enclosure.

Connection Enclosure Cable from Bottom

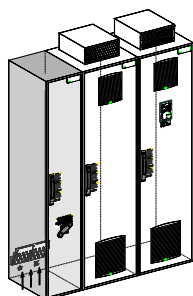

This separate connection enclosure makes it possible to insert and connect the mains cables and motor cables from the bottom of the enclosure.

The separated connecting enclosure contains all power terminals and the mains disconnection (e.g. main switch), which makes a voltage disconnection of the basic device during maintenance possible.

Furthermore, the connecting enclosure provides enough space for additional customizations.

NOTE: The additional connecting enclosure increases the total width of the enclosure.

Enclosure Lighting

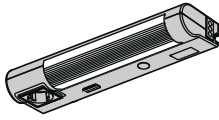

In order to make maintenance easier, the enclosure can be equipped with a lighting, which is switched on when opening the enclosure door.

The lighting is externally supplied and so it is also available at switched off mains supply. Furthermore, a power socket according to VDE standard (230 V / 50 Hz, 2 A) is located on the lighting to operate smaller consumers on-site.

NOTE: The additional power supply at terminals X200 has to be provided by the user.

- Rated voltage: 230 V
- Rated frequency: 50/60 Hz
- Rated power: 500 VA

This option requires an additional external 230 V power supply with overvoltage category 1 or 2 (according to IEC/UL 61800-5-1) connected to terminals X200.

⚡ ⚠ DANGER

HAZARD OF ELECTRIC SHOCK
Verify that the external power supply complies with all national and local electrical code requirements.
Failure to follow these instructions will result in death or serious injury.

Enclosure Heating

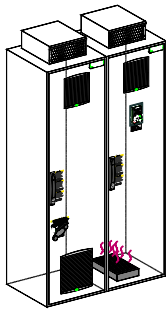

This customization is used to heat the enclosure in order to avoid frost and condensation at an ambient temperature up to -10°C. The enclosure heating is externally supplied, so the enclosure can be also heated when mains supply is switched off.

NOTE: The additional power supply at terminals X200 has to be provided by the user.

- Rated voltage: 230 V
- Rated frequency: 50/60 Hz
- Rated power: 400...800 VA

This option requires an additional external 230 V power supply with overvoltage category 1 or 2 (according to IEC/UL 61800-5-1) connected to terminals X200.

⚡ ⚠ DANGER

HAZARD OF ELECTRIC SHOCK
Verify that the external power supply complies with all national and local electrical code requirements.
Failure to follow these instructions will result in death or serious injury.

Modified Wiring Colors

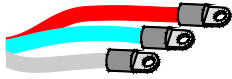

This option contains modified wiring colors as well as red, white and blue heat shrink tubes at the power cables.

Control Options

Key Switch "local / remote"

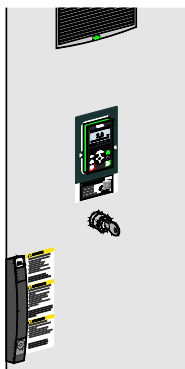

The key switch "local / remote" allows to switch between local operation (via the graphical operating panel) or remote control (terminals or bus). The switch can be only operated with a key and so it can be only switched by authorized personnel.

Ethernet Port on Front Door

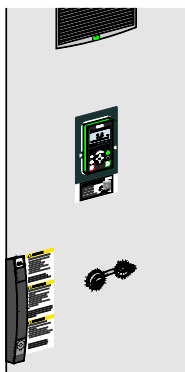

The Ethernet port in the enclosure door allows access to the frequency inverter without opening the enclosure door. The plug can be closed with a dust protection cap.

I/O Expansion Cards

You will find detailed information in the respective documentation. See listing under chapter "Related Documents", page 9.

Expansion Card With Additional Inputs / Outputs



Expansion card for additional analog and digital inputs and outputs (6 digital inputs, 2 digital outputs, 2 analog inputs)

You will find further information at chapter "Option "Logic and Analog I/O Card"", page 91.

Expansion Card With Relay Outputs



Expansion card with three additional relay outputs

You will find further information at chapter "Option "Relay Output Card"", page 94.

Communication Cards

You will find detailed information in the respective documentation. See listing under chapter "Related Documents", page 9.

Communication Card CANopen Daisy Chain



Option card for control of the inverter via CANopen Daisy Chain

Communication Card CANopen SUB-D9



Option card for control of the inverter via CANopen with SUB-D port.

Communication Card CANopen With Screw Terminals



Option card for control of the inverter via CANopen with screw terminals

Communication Card DeviceNet



Option card for control of the inverter via DeviceNet

Communication Card Profibus DP



Option card for control of the inverter via Profibus DP V1

Communication Card PROFINET



Option card for control of the inverter via PROFINET

Communication Card EtherCAT Daisy Chain



Option card for control of the inverter via EtherCAT Daisy Chain

Encoder Interface Modules

You will find detailed information in the respective documentation. See listing under chapter "Related Documents", page 9.

Digital Encoder Interface Module 5/12 V



Interface module for connecting a digital encoder

Analog Encoder Interface Module



Interface module for connecting an analog encoder

Resolver Interface Module



Interface module for connecting a resolver

HTL Encoder Interface Module



Interface module for connecting an encoder with push-pull (HTL) output driver

Functional Safety

Safe Torque Off (STO)

The Altivar Process is equipped with the safety function "Safe Torque Off STO" according to ISO 13849-1, IEC/EN 61508, IEC/EN 60204-1, which helps to prevent any unintended start-up of the motor.

- Inputs $\overline{\text{STOA}}$ and $\overline{\text{STOB}}$ directly at the control terminals of the control block.
This function fulfills, when correctly wired, the machine standard ISO 13849-1, Performance level PL e, the IEC/EN 61508 Safety integrity level SIL 3 standard for functional safety and the power drive system standard IEC/EN 61800-5-2.
- Customization SIL3, stop category 0 / PL e
The triggering of the safety function leads to a coast down of the drive and helps to prevent an unintended restart.
- Customization SIL3, stop category 1 / PL e
The triggering of this function starts a controlled deceleration, shuts down the drive after the set time and helps to prevent an unintended restart.

NOTE: You will find further information in the Safety Function Manual ([NHA80947](#)).

Safe Torque Off STO – SIL 3 Stop Category 0 / Performance Level PL e

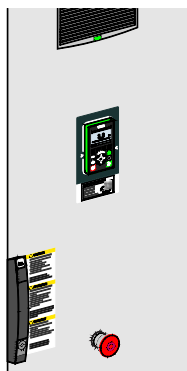

Via an EMERGENCY STOP button in the enclosure door or further implemented, external monitoring equipment, the torque at the motor can be switched off according SIL 3 stop category 0 / performance level PL e.

The triggering of the safety function leads to a coast down of the drive and helps to prevent an unintended restart.

Safe Torque Off STO – SIL 3 Stop Category 1 / Performance Level PL e

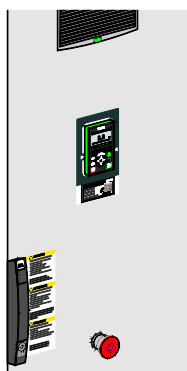

Via an EMERGENCY STOP button in the enclosure door or further implemented, external monitoring equipment, the torque at the motor can be switched off according SIL 3 stop category 1 / performance level PL e.

The triggering of this function starts a controlled deceleration, shuts down the drive after the set time and helps to prevent an unintended restart.

Display Options

Front Display Module (FDM)

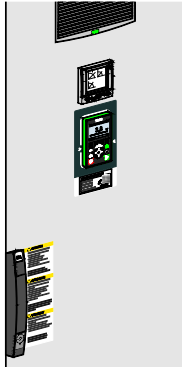

A display element mounted in the enclosure door enables clear indication of real-time values like:

- Indication of mains currents (3x)
- Mains voltages (3x phase voltages, 3x phase-to-phase voltages)
- Mains power

These values can be indicated graphically or digital.

The display element is provided with backlight for increased readability.

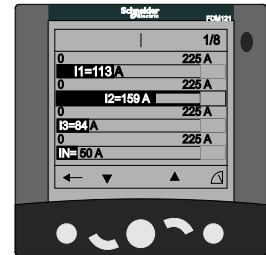

Indicator Lamps on Front Door

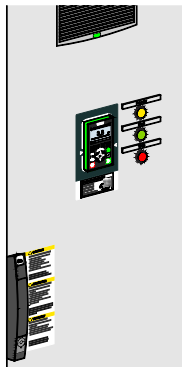

For quick, optical diagnostics of the actual operating state from a greater distance, the enclosure can be equipped with indicator lamps.

The lamps show following operating states:

Operating state	Indicator lamp	Labeling
Ready	Yellow	READY
Operation	Green	RUN
Detected fault	Red	TRIP

Motor Options

Motor Monitoring PTC

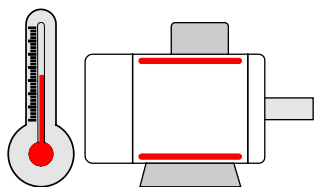

If the motor is equipped with integrated thermistor sensors to help to protect against thermal overload, they can be directly connected to a thermistor relay inside the Altivar Process Drive System.

If the frequency inverter detects an overtemperature at the motor, the drive stops the motor and generates an error message at the display. This operating state is also forwarded to the status relays and to the fieldbus.

NOTE: When protective separation of the thermistor sensors in the motor cannot be guaranteed or in case of long motor cables, this option is highly recommended.

Motor Monitoring PTC with ATEX Certificate

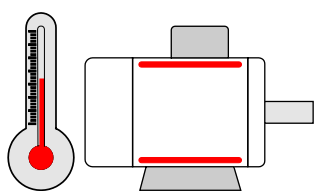

The motor monitoring PTC with ATEX certificate is used to monitor the thermistor sensors of motors which are installed in hazardous area (explosive atmosphere).

If the frequency inverter detects the overtemperature at the motor, the drive stops the motor and generates an error message at the display. This operating state is also forwarded to the status relays and to the fieldbus. The monitoring relay additionally triggers a safe shut-down of the drive.

This equipment has been designed to operate outside of any hazardous location. Only install this equipment in zones known to be free of hazardous atmosphere.

⚠ DANGER

POTENTIAL FOR EXPLOSION

Install and use this equipment in non-hazardous locations only.

Failure to follow these instructions will result in death or serious injury.

Motor monitoring Pt100/Pt1000/KTY

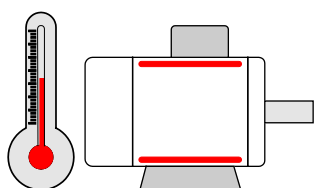

If the motor is equipped with integrated temperature sensors (Pt100, Pt1000, KTY 83/84) in the winding to help to protect against thermal overload, they can be directly connected to the relay inside the Altivar Process Drive System.

If the set temperature at the motor is exceeded, a warning message is generated. When the temperature is further rising over a set value, the drive is stopped and an error message is generated. The operating states are also forwarded to the status relays and to the fieldbus.

NOTE: When protective separation of the thermistor sensors in the motor cannot be guaranteed or in case of long motor cables, this option is highly recommended.

Bearing Monitoring Pt100/Pt1000/KTY

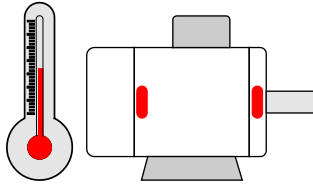

If the motor is equipped with integrated temperature sensors (Pt100, Pt1000, KTY 83/84) in the bearings to help to protect against thermal overload, they can be directly connected to the relay inside the Altivar Process Drive System.

If the set temperature at the motor is exceeded, a warning message is generated. When the temperature is further rising over a set value, the drive is stopped and an error message is generated. The operating states are also forwarded to the status relays and to the fieldbus.

NOTE: When protective separation of the thermistor sensors in the motor cannot be guaranteed or in case of long motor cables, this option is highly recommended.

dv/dt Filter Choke 150 m

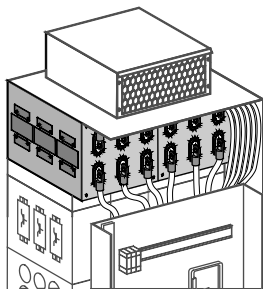

The use of the customization dv/dt filter choke 150 m has significant advantages concerning the operation of the drive:

- Decrease of the dv/dt and peak voltage load of the motor
- Prevention of common mode bearing currents in the motor – especially important at high power
- Great reduction of the influences to other cables – important if the separate laying of motor cables is not possible
- In case of long motor cables up to 150 m shielded or up to 250 m unshielded
- dv/dt filter choke 150 m can be installed without enlarged enclosure width.

NOTE: You will find further information about long motor cables under chapter "Length of Motor Cables", page 72.

dv/dt Filter Choke 300 m

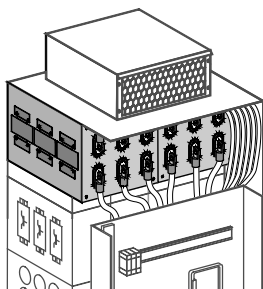

The use of the customization dv/dt filter choke 300 m has significant advantages concerning the operation of the drive:

- Decrease of the dv/dt and peak voltage load of the motor
- Prevention of common mode bearing currents in the motor – especially important at high power
- Great reduction of the influences to other cables – important if the separate laying of motor cables is not ensured
- In case of long motor cables up to 300 m shielded or up to 500 m unshielded
- dv/dt filter choke 300 m can be installed without enlarged enclosure width.

NOTE: You will find further information about long motor cables under chapter "Length of Motor Cables", page 72.

Motor Heating

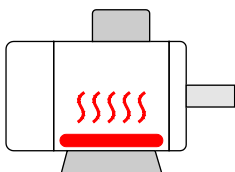

The motor standstill heating is used to avoid condensate and frost damages at standstill of the motors in cold environment. It is activated when the motor is shut down.

Mains Supply

Circuit Breaker

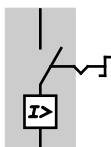

The circuit breaker is used for mains disconnection instead of the main switch. It is operated by a handle in the enclosure door.
The circuit breaker can be optionally equipped with an undervoltage coil and motor.

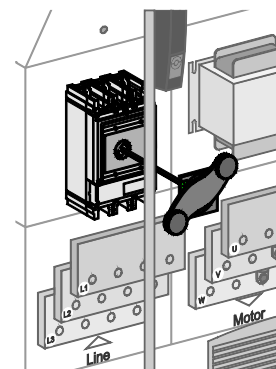

Undervoltage Coil for Circuit Breaker 230 V

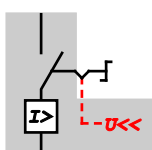

When there is no voltage at the undervoltage coil, the circuit breaker switches off. The undervoltage coil is built into the circuit breaker and is wired to the option terminals.

Specification of the control terminals

X200: 6/14 External control voltage
220...240 V AC 50/60 Hz

- NOTE:**
- Only when control voltage is applied, the circuit breaker can be switched on manually.
 - You will find further information about the topic wiring under chapter "Option Terminals", page 95.

Motor for Circuit Breaker 230 V

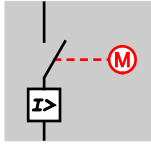

Remote control of the circuit breaker via control commands is possible by means of this motor drive. The motor drive is built into the circuit breaker and is wired to the option terminals.

Specification of the control terminals

- X200: 7/15 External control voltage
220...240 V AC 50/60 Hz
- X200: 8 Start request
- X200: 16 Stop request

Specification of the motor drive:

- External control circuit voltage:
 - 230 V AC ± 5% 50/60 Hz
- Reaction time:
 - < 80 ms when closing
 - < 600 ms when opening
- Power input:
 - ≤ 500 VA when closing
 - ≤ 500 VA when opening

- NOTE:**
- At this customization no handle for the circuit breaker is possible.
 - You will find further information about the topic wiring under chapter "Option Terminals", page 95.
 - You will find further information about the topic switching rate under chapter "Switching Rate", page 26.

Automated Mains Disconnect

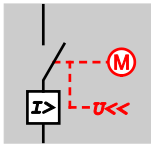

With the automated mains disconnect the Altivar Process Drive System is autonomously disconnected from the mains in case of a stop request, a detected fault or a safety disconnection via STO. The control voltage still remains. When a start request is given, the mains voltage is automatically connected again.

The control voltage is tapped upstream to the circuit breaker. So an additional main switch (for the control voltage) is integrated for total disconnection of the Altivar Process Drive System.

The automated mains disconnect contains following components:

- Circuit breaker with undervoltage coil and motor
- Timer module for delayed triggering of the undervoltage coil (200 ms)
- Main switch for control voltage

NOTE: Observe the maximum switching rate under chapter "Switching Rate", page 26.

12-pulse Supply

The ATV960 frequency inverters can be equipped with parallel input rectifiers for 12-pulse rectification on request.

The supply results from a separate transformer with two out-of-phase secondary windings (e.g. superimposing transformer Yy6 Yd5).

Due to the lower tolerances of superimposing transformer in zig-zag-connection you can assume that the output current is approximately 7 % lower.

Example: For 90 kW instead of 2 x 90 A at 400 V only 2 x 84 A.

If the existing mains distortion is mainly caused by frequency inverters with normal 6-pulse-circuit, we highly recommend a superimposing transformer in zig-zag-connection ($\pm 15^\circ$ phase shift at each secondary windings e.g. Yy1130 Yy0030).

On the main side of the transformer the 5th and 7th current harmonics are practically non-existent as they have been cancelled by the shifted transformer windings.

Due to the internal circuit structure it is possible to operate a single frequency inverter as well as several frequency inverters in parallel at one transformer.

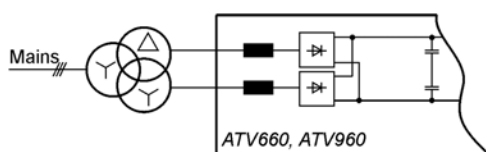

The following specifications must be kept:

Transformer:

- | | |
|---|-----------------------------------|
| • Converter transformer for 12-pulse supply with half-controlled rectifier bridges in a common voltage DC link. | |
| • Recommended design: | Superimposing |
| • Nominal voltage at the primary side: | According to the application |
| • Voltage adaptation at the primary side: | +5 % / +2.5 % / 0 / -2.5 % / -5 % |
| • Nominal output current: | See the following table |
| • Current harmonics at the secondary side: | See the following table |
| • Nominal output voltage (= no-load voltage): | See the following table |
| • Tolerance of the secondary voltages to each other: | < 0.3 % (< 0.1 %) of U_{NOM} |
| • Short-circuit voltage: | See the following table |
| • Tolerance of the relative short-circuit voltage: | ± 10 % of U_{SC-NOM} |
| • Tolerance of the relative short-circuit voltage between both secondary windings | < 5 % (< 2 %) of U_{SC-NOM} |
| • Further specifications: | According to the application |
| • Tolerance for unbalance of phase-shift | ($\pm 0.5^\circ$) |

Mains:

- Allowed mains distortion: THD(u) < 8 %
- Max. single harmonic (5.): < 5 %

() Values in brackets for transformer in zig-zag-connection ($\pm 15^\circ$ phase shift at both secondary windings e.g. Yy1130 Yy0030)

Recommended values for dimensioning a "12-pulse transformer"

Inverter power [kW]	Transformer			Inverter power [hp]	Transformer				
	Output current				Output current		Short-circuit voltage	Harmonics	
	400 V	500 V	690 V		480 V	600 V		Secondary (THDi LV)	Primary (THDi HV)
90	2x 90 A	2x 70 A	2x 60 A	125	2x 80 A	2x 65 A	4 %	< 40 %	≤12 %
110	2x 110 A	2x 80 A	2x 65 A	150	2x 95 A	2x 75 A	4 %	< 42 %	≤12 %
132	2x 130 A	2x 95 A	2x 75 A	200	2x 125 A	2x 115 A	4 %	< 42 %	≤12 %
160	2x 155 A	2x 120 A	2x 90 A	250	2x 155 A	2x 140 A	4 %	< 42 %	≤12 %
200	2x 190 A	2x 145 A	2x 120 A	300	2x 185 A	2x 160 A	4 %	< 42 %	≤12 %
250	2x 240 A	2x 180 A	2x 145 A	400	2x 245 A	2x 200 A	4 %	< 42 %	≤12 %
315	2x 300 A	2x 230 A	2x 180 A	500	2x 305 A	2x 250 A	4 %	< 42 %	≤12 %
355	2x 340 A	2x 250 A	2x 210 A	550	2x 330 A	2x 275 A	4 %	< 42 %	≤12 %
400	2x 380 A	2x 285 A	2x 230 A	600	2x 365 A	2x 290 A	4 %	< 40 %	≤12 %
450	2x 440 A	2x 340 A	2x 260 A	650	2x 400 A	2x 320 A	4 %	< 40 %	≤12 %
500	2x 490 A	2x 385 A	2x 285 A	700	2x 420 A	2x 340 A	6 %	< 33 %	≤10 %
560	2x 550 A	2x 440 A	2x 320 A	800	2x 480 A	2x 395 A	6 %	< 33 %	≤10 %
630	2x 610 A	2x 490 A	2x 365 A	900	2x 540 A	2x 430 A	6 %	< 33 %	≤10 %
710	2x 680 A	2x 540 A	2x 420 A	1000	2x 600 A	2x 480 A	6 %	< 33 %	≤10 %
800	2x 770 A	2x 610 A	2x 465 A	1100	–	2x 540 A	6 %	< 33 %	≤10 %
900	2x 860 A	2x 685 A	2x 525 A	1250	–	2x 590 A	6 %	< 33 %	≤10 %
1000	2x 940 A	2x 770 A	2x 570 A	1400	–	2x 660 A	6 %	< 33 %	≤10 %
1100	2x 1040 A	2x 840 A	2x 620 A	1600	–	2x 755 A	6 %	< 33 %	≤10 %
1200	2x 1110 A	2x 900 A	2x 665 A	1700	–	2x 790 A	6 %	< 33 %	≤10 %
1300	2x 1200 A	2x 980 A	2x 725 A	1900	–	2x 885 A	6 %	< 33 %	≤10 %
1400	2x 1300 A	2x 1050 A	2x 780 A	2000	–	2x 930 A	6 %	< 33 %	≤10 %
1500	–	2x 1120 A	2x 840 A	2100	–	2x 980 A	6 %	< 33 %	≤10 %
1800	–	2x 1330 A	2x 1000 A	2200	–	2x 1020 A	6 %	< 33 %	≤10 %
2000	–	–	2x 1100 A	2500	–	2x 1150 A	6 %	< 33 %	≤10 %
2100	–	–	2x 1150 A	–	–	–	6 %	< 33 %	≤10 %
2400	–	–	2x 1300 A	–	–	–	6 %	< 33 %	≤10 %

Recommended output voltage for the transformer

The nominal output voltage of a transformer is specified at no load operation. Therefore this value should be 3...5 % higher than the rated voltage of the drive.

Inverter	Transformer output voltage phase / phase (no load)						
	Nominal voltage						
	380 V	400 V	440 V	480 V	500 V	600 V	690 V
400 V range	400 V	425 V	460 V	500 V	–	–	–
690 V range	–	–	–	–	525 V	630 V	715 V

Braking Option

Braking Unit Option BUO

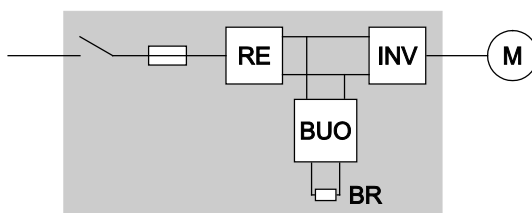

The use of a braking unit is required, if:

- More power is returned to the DC link during the braking procedure than the losses in the motor and the inverter amount to or
- The application requires very short braking times.

The braking unit option BUO is placed in an own enclosure and is equipped with a voltage regulation to control the braking transistors.

If the DC link voltage exceeds an adjustable value, the external braking resistor is switched into the DC link as a consumer. The braking resistor converts the power incurred during generator operation into heat. This helps to avoid a further rising of the DC link voltage and thus a shut-down with overvoltage.

The key benefits of the braking unit option BUO are:

- Significant reduction of capacitor load due to three-phase design
- Monitoring of the braking resistors for overload and interruption
- Shielded braking unit lines allow the compliance with the EMC limits
- Integrated protection against short-circuits and ground faults for the braking resistor and the wiring

The braking unit option BUO has following features and characteristics:

- The ModBuo●●● braking option is 3-phase designed and so it requires three braking resistors (possibly in a housing with six terminals).
- The braking option ModBuo●●● controls itself. But for monitoring the function there is an additional internal bus connection to the frequency inverter. So all settings and displays can take place at the interface of the inverter.
- The braking resistor is monitored for short-circuit and interruption; provided that the nominal power of the resistor is correctly set. The protection against ground faults is realized via the integrated circuit breaker.
- For monitoring and diagnostics all braking resistors are subsumed to one group.
- For simple applications it is possible to assign a braking unit and braking resistors with less power.
- If the installed peak braking power is not sufficient, the inverter automatically extends the deceleration ramp in order to prevent a shut-down. However, if short braking times must be kept, select a braking resistor according to the maximum braking power (see).

Technical Data Braking Unit

Braking unit	ModBuo	C16●4	C31●4	C50●4	C63●4	C80●4
Nominal data						
Size	Single Drive System	1c			2c	
Braking voltage max.		780 V dc	780 V dc	780 V dc	780 V dc	780 V dc
Braking power						
At 780 V dc	12s / 240s (= 5%)	200 kW	400 kW	600 kW	800 kW	1000 kW
At 755 V dc	12s / 240s (= 5%)	180 kW	360 kW	540 kW	720 kW	900 kW
At 720 V dc	12s / 240s (=5%)	170 kW	340 kW	510 kW	680 kW	850 kW
	36s / 240s (= 15%)	150 kW	300 kW	450 kW	600 kW	750 kW
	120s / 240s (= 50%)	120 kW	240 kW	360 kW	480 kW	600 kW
Continuous operation	(= 100%)	100 kW	200 kW	300 kW	400 kW	500 kW
Braking resistor						
Braking resistor	Min. ⁽¹⁾	3x 6.0 Ω	3x 3.0 Ω	3x 2.2 Ω	6x 3.0 Ω	6x 2.6 Ω
	Max. ⁽²⁾	3x 8.0 Ω	3x 4.0 Ω	3x 2.7 Ω	6x 4.0 Ω	6x 3.4 Ω
Characteristics						
Maximum current I_{max}		85	170	255	340	425
Heat losses at cont. operation	Total losses	1050 W	1600 W	2200 W	3300 W	3600 W
	Control part only	280 W	310 W	350 W	460 W	510 W
Auxiliary voltage	230V, 50/60Hz	250 W	250 W	250 W	500 W	500 W
Enclosure width		400 mm			800 mm	
Weight	Net	260 kg	260 kg	260 kg	510 kg	510 kg
	Gross	270 kg	270 kg	270 kg	530 kg	530 kg
Arrangement	Single Drive System	Right			Right	
Ambient conditions						
Air flow	Power part	580 m ³ /h	580 m ³ /h	580 m ³ /h	1160 m ³ /h	1160 m ³ /h
	Control part	140 m ³ /h	140 m ³ /h	140 m ³ /h	280 m ³ /h	280 m ³ /h
Cable cross section						
Number of terminals		6			12	
Cable cross section	Per terminal	2x M12			2x M12	
	Max. cross-section	4x 120mm ²			4x 120mm ²	
<p>(1) Nominal value of the braking resistance which may not fall short due to help to protect the braking transistor (-10 % tolerance)</p> <p>(2) Nominal resistance value at which a peak braking power of 125...150 % of the nominal inverter power HD (Heavy Duty) can still be reached (+25 % tolerance including temperature rise)</p>						

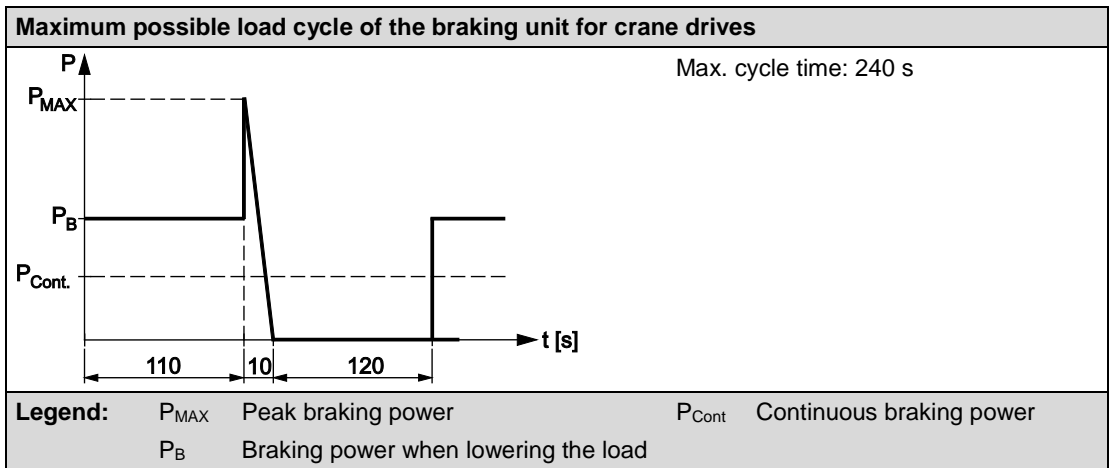

Dimensions Braking Unit Option IP23 Size 1c



Interior View Braking Unit Option IP23 for Size 1c

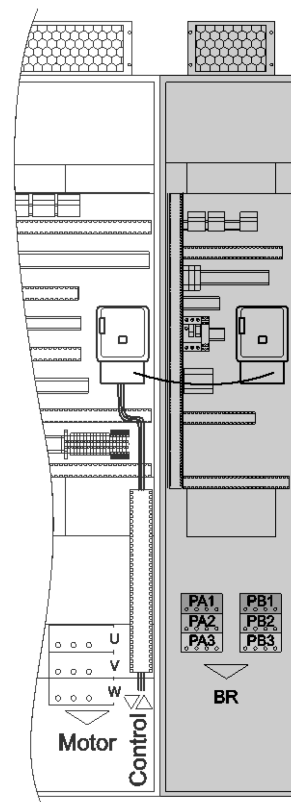

NOTE: At protection degree IP54 the enclosure height is increased by 200 mm.

Dimensions Braking Unit Option IP23 Size 2c

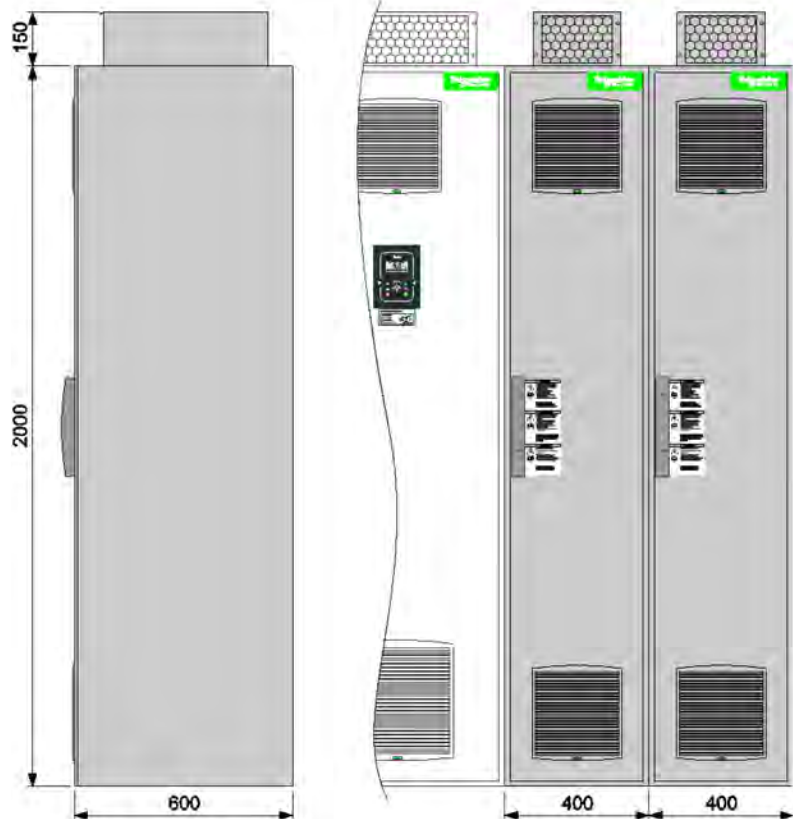

Interior View Braking Unit Option IP23 for Size 2c

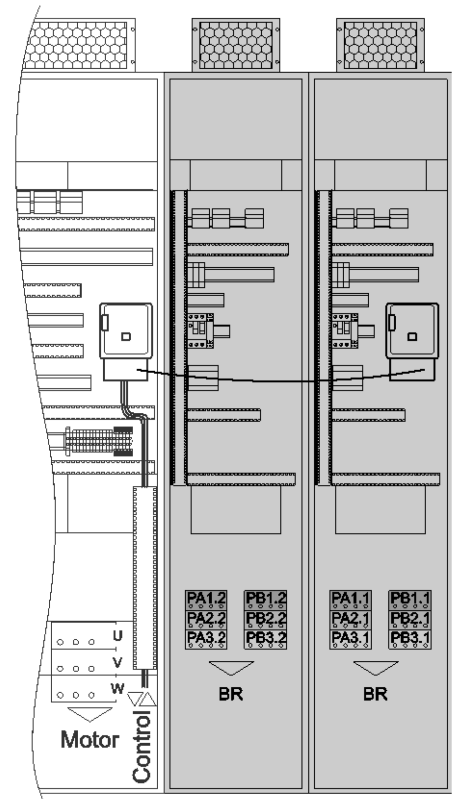

NOTE: At protection degree IP54 the enclosure height is increased by 200 mm.

Braking Resistors BR

The braking resistor converts the power accumulating during generator operation into heat and thus helps to prevent a further rising of the DC link voltage.

Braking resistors can be only connected to Drive Systems which are equipped with an braking unit option BUO.

When allocating the braking resistors to the frequency inverters, observe the following points:

- Minimum braking resistance per inverter power
- Required peak braking power and cycle time
- Necessary continuous power depending on the application requirements
- Recommended assignment of braking resistors

Choose a suitable place for installing the braking resistors where the energy can dissipate unhindered via the ambient air.

Thereby the surface of the resistor may reach up to 250°C. So the braking resistor must be mounted on non-combustible material.

The unhindered air flow may not be impaired by other devices or casing parts!

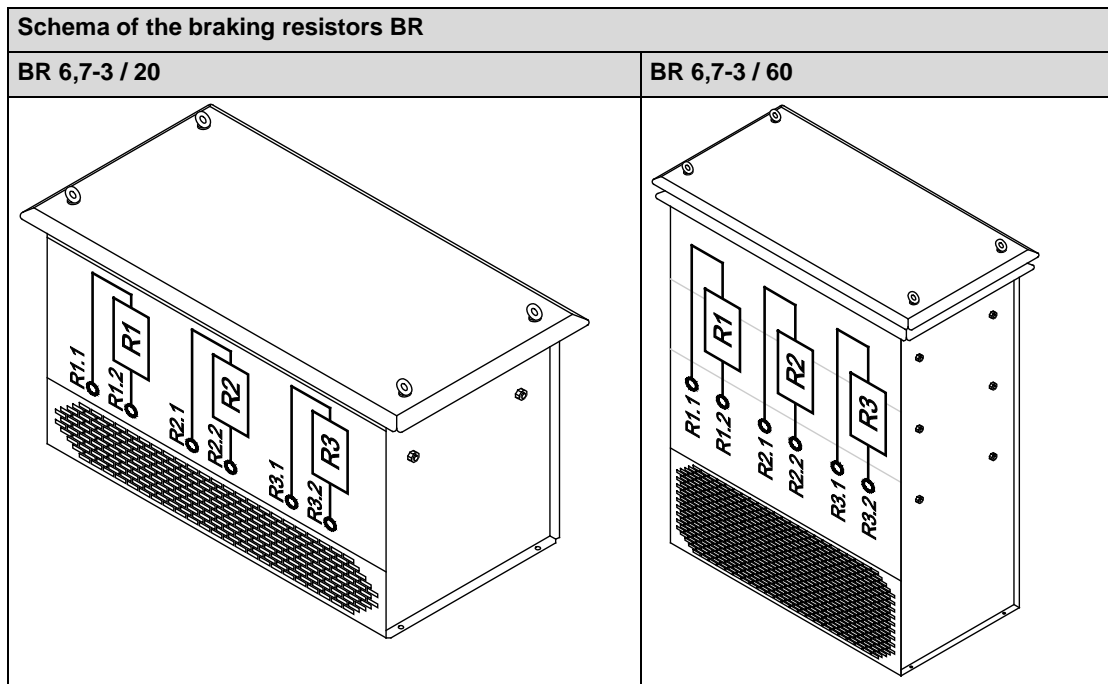

⚠ WARNING

HOT SURFACES

- Ensure that it is not possible to make any contact with a hot braking resistor.
- Do not allow flammable or heat-sensitive parts in the immediate vicinity of the braking resistor.
- Verify that the heat dissipation is sufficient by performing a test run under maximum load conditions.

Failure to follow these instructions can result in death, serious injury or equipment damage.

Technical Data Braking Resistor

General technical data	
Nominal tolerance at 20°C	±10 %; additionally +15 % resulting from the temperature rise during operation
Thermal protection	Software function in the Drive System (or by a thermal relay / motor protection relay)
Ambient conditions	
Ambient temperature	-25...+40 °C; above +40 °C with derating of 4 % per 10 K
Storage / Transport temperature	-25...+70 °C
Cooling	Natural convection
Thermal time constant	140 s ⁽¹⁾
Protection degree	IP23
Altitude	Up to 1000 m, above with derating of 1 % per 100 m
Standards	
Standards	CE ⁽²⁾
(1) Set this value via parameter [Braking Resist T Constant] $brtC$.	
(2) For applications, which require a UL certification, you can choose resistors from the Schneider Electric standard program (e.g. 3x VW3 A7 755 instead of 1x VW3 A7 791).	

Braking resistor	BR 6,7-3 / 20	BR 6,7-3 / 60
Reference number	VW3 A7 790	VW3 A7 791
Nominal data		
Resistance	3x 6.7 Ω	3x 6.7 Ω
Continuous power total	20 kW	60 kW
Parameter brP (x number of resistors connected in parallel)	20	60
Peak braking power at 120 s cycle repetitive		
At 680 V dc	150 kW (max. 7 % duty cycle)	150 kW (max. 24 % duty cycle)
At 780 V dc	200 kW (max. 5 % duty cycle)	200 kW (max. 18 % duty cycle)
At 975 V dc	300 kW (max. 3 % duty cycle)	300 kW (max. 11 % duty cycle)
At 1075 V dc	380 kW (max. 2 % duty cycle)	380 kW (max. 8 % duty cycle)
Duty cycle ED and cycle time		
At 115 kW braking power	12 % duty cycle at 120 s cycle ($t_{ON} = 15$ s, $t_{OFF} = 105$ s; repetitive)	50 % duty cycle at 120 s cycle ($t_{ON} = 60$ s, $t_{OFF} = 60$ s; max. 3 cycles, then at least 20 min. pause)
		40 % duty cycle at 120 s cycle ($t_{ON} = 48$ s, $t_{OFF} = 72$ s; repetitive)
		30 % duty cycle at 200 s cycle ($t_{ON} = 60$ s, $t_{OFF} = 140$ s; repetitive)
Characteristics		
Setting value thermal relay	35 A per phase	55 A per phase
Weight	Net 50 kg Gross 70 kg	120 kg 150 kg
Connection		
Connection	6x M10 2x M10 for PE	6x M10 2x M10 for PE

Dimensions BR 6,7-3 / 20

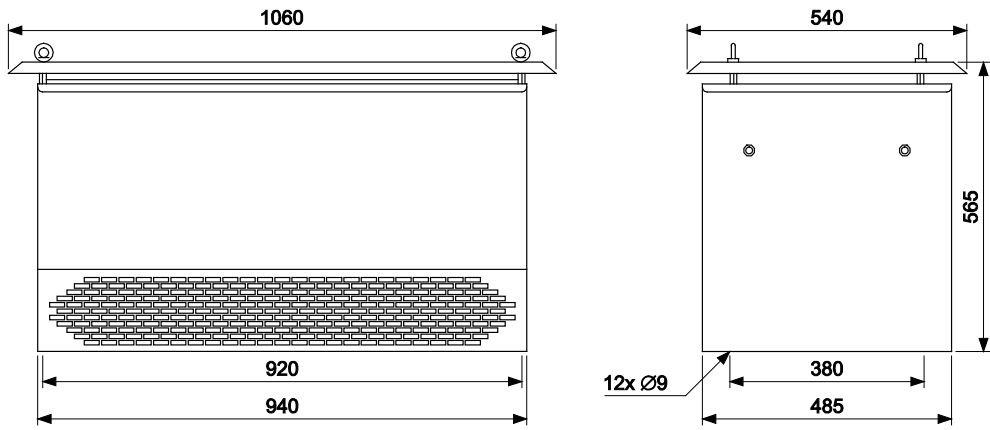

Dimensions BR 6,7-3 / 60

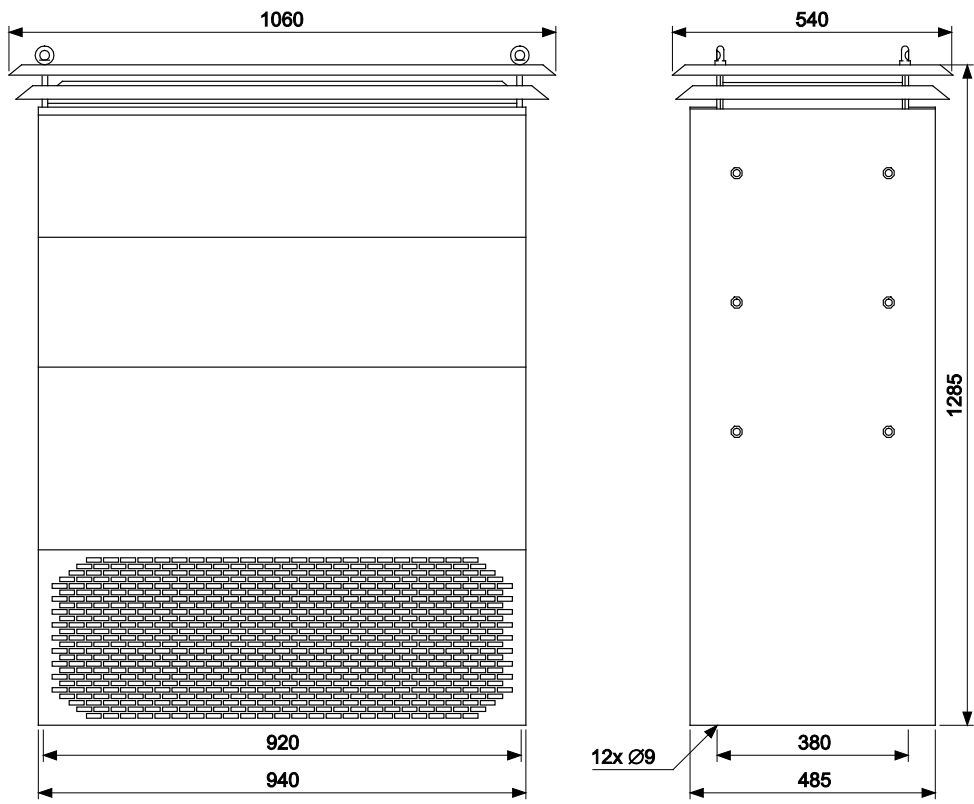

Monitoring Options

Remote Monitoring

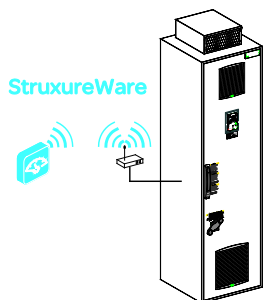

With remote monitoring the Altivar Process Drive System can be monitored via Ethernet or Modbus using a PC, tablet or smart phone.

The delivered gateway records the data of the Drive System in regular intervals. The collected data are transmitted using an integrated GPRS modem via the mobile phone network to the Schneider Electric StruxureWare Energy Operation network.

You can easily access the provided data of your Altivar Process System using PC, tablet or smart phone in order to analyze them and to be up-to-date:

- Notification per email or SMS when reaching warning or error states
- Preset reminders per email for maintenance purpose, inspection,...
- Cyclical sending of status reports

Via the predefined data model the following values are monitored 24/7 and logged:

Registered data	
<ul style="list-style-type: none"> • Mains voltage • Mains frequency • DC link voltage • Input / output voltage • Motor current and voltage • Motor speed • Motor torque 	<ul style="list-style-type: none"> • Energy consumption • Energy saving by frequency inverter operation • Saving of CO₂ emission • Thermal state of motor and Drive System • Operating state of Drive System • Event memory with detailed information • Application data (input / output pressure, flow,...)

The module contains additional inputs in order to record further measures:

- 2 temperature sensors (Pt100 or Pt1000)
- 6 digital inputs
- 2 analog inputs

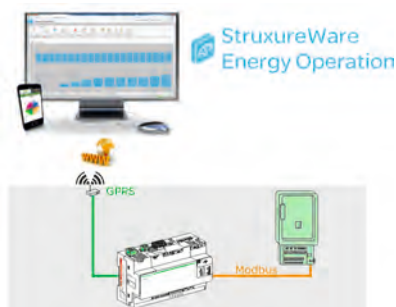

NOTE: For this option a service contract is necessary which will imply additional costs.

Packaging

Safety Labels in Local Language

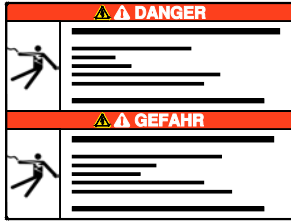

All Altivar Process Drive Systems are delivered with safety labels in English and French.

Optionally the devices can be also ordered with labels in the local language.

Seaworthy Packaging

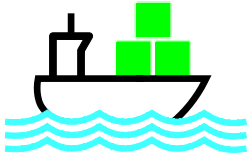

This option contains a seaworthy packaging for transport by ship. The packaging complies with the HPE packaging guidelines (federal association for wooden packages, pallets and export packaging in Germany).

