

# Altivar Process

## ATV680 Low Harmonic Drive Systems

### Handbook

English

10/2017



# Altivar Process

## Low Harmonic Drive Systems



The customized solution for your drive

"Ready-to-use" Low Harmonic Drive Systems:

- + New Low Harmonic system concept
- + Developed on highest quality level
- + Manufactured according to your needs
- + Tested at full-load operating conditions
- + Pre-set appropriate to the design



### Newest 3-level architecture

- + Total current distortion factor THD(i) < 5 %
- + Improved life-time of the motor due to reduced voltage load
- + Less heat losses compared to the classic AFE architecture
- + Compact dimensions due to optimized filter components

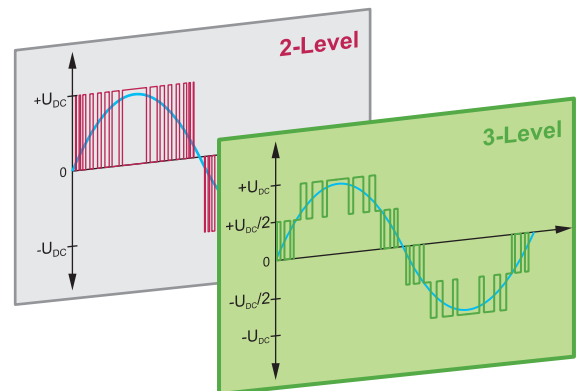

### The energy-saving drive solution

- + Up to 60% energy saving at standby due to the innovative "Stop & Go" operation without additional costs
- + Intelligent control of the internal fans depending on the operation
- + Optimal energy efficiency over the whole life cycle
- + Logging and graphical presentation of the absorbed power

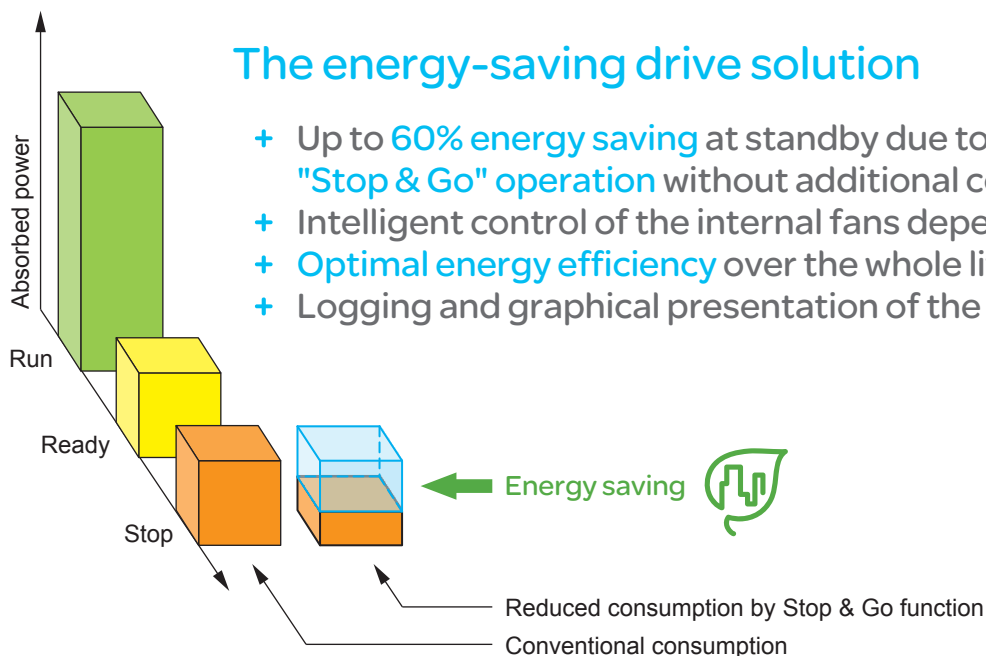



## Perfect monitoring of your process

- + Integrated pump curves for process optimization
- + Monitoring of the pump efficiency
- + Notification of critical operating points without additional sensors
- + Process integration with pressure-, flow- and level-control including compensation of flow losses



## Simple embedding into PLC environments

- + Easy integration thanks to standardized FDT/DTM and ODVA technology
- + Support by predefined libraries
- + Easy access via PC, tablet or smartphone
- + Secure connection via "Cyber-secured Ethernet"



## Sophisticated service concept with QR code

- + Modular design allows easy logistics of spare parts
- + Optimized costs of maintenance due to dynamic maintenance schedule with integrated monitoring of the individual components
- + Simple exchange of power modules and fans
- + Quick assistance with dynamic QR codes and Customer Care App



---

The information provided in this documentation contains general descriptions and/or technical characteristics of the performance of the products contained herein. This documentation is not intended as a substitute for and is not to be used for determining suitability or reliability of these products for specific user applications. It is the duty of any such user or integrator to perform the appropriate and complete risk analysis, evaluation and testing of the products with respect to the relevant specific application or use thereof. Neither Schneider Electric nor any of its affiliates or subsidiaries shall be responsible or liable for misuse of the information contained herein. If you have any suggestions for improvements or amendments or have found errors in this publication, please notify us.

You agree not to reproduce, other than for your own personal, noncommercial use, all or part of this document on any medium whatsoever without permission of Schneider Electric, given in writing. You also agree not to establish any hypertext links to this document or its content. Schneider Electric does not grant any right or license for the personal and noncommercial use of the document or its content, except for a non-exclusive license to consult it on an "as is" basis, at your own risk. All other rights are reserved.

All pertinent state, regional, and local safety regulations must be observed when installing and using this product. For reasons of safety and to help ensure compliance with documented system data, only the manufacturer should perform repairs to components.

When devices are used for applications with technical safety requirements, the relevant instructions must be followed.

Failure to use Schneider Electric software or approved software with our hardware products may result in injury, harm, or improper operating results.

Failure to observe this information can result in injury or equipment damage.

© 2017 Schneider Electric. All rights reserved.

---

# Table of Contents

---



	<b>Safety Information</b> .....	<b>7</b>
	<b>About the Book</b> .....	<b>8</b>
<b>Chapter 1</b>	<b>Drive Systems</b> .....	<b>11</b>
	Overview .....	12
	ATV680 – Low Harmonic Drive Systems .....	13
	Expandability .....	16
<b>Chapter 2</b>	<b>General Specification</b> .....	<b>19</b>
	Quality .....	20
	Mains Conditions .....	24
	Protection of the Plant .....	27
<b>Chapter 3</b>	<b>ATV680●●●●4X1</b> .....	<b>31</b>
	Description .....	32
	Specification .....	36
	Circuit Diagram .....	64
	Mains Connection .....	65
	Motor Connection .....	68
	Customizations .....	75
<b>Chapter 4</b>	<b>Wiring of the Control Terminals</b> .....	<b>77</b>
	Design/Position of the Individual Terminals .....	78
	Control Block .....	79
	Option "Logic and Analog I/O Card" .....	86
	Option "Relay Output Card" .....	89
	Option Terminals .....	90
<b>Chapter 5</b>	<b>Customizations</b> .....	<b>93</b>
	Enclosure Options .....	94
	Control Options .....	98
	I/O Expansion Cards .....	99
	Communication Cards .....	100
	Functional Safety .....	102
	Display Options .....	103
	Motor Options .....	104
	Mains Supply .....	106
	Monitoring Options .....	108
	Packaging .....	109





## Important Information

### NOTICE

Read these instructions carefully, and look at the equipment to become familiar with the device before trying to install, operate, or maintain it. The following special messages may appear throughout this documentation or on the equipment to warn of potential hazards or to call attention to information that clarifies or simplifies a procedure.



The addition of this symbol to a "Danger" or "Warning" safety label indicates that an electrical hazard exists which will result in personal injury if the instructions are not followed.



This is the safety alert symbol. It is used to alert you to potential personal injury hazards. Obey all safety messages that follow this symbol to avoid possible injury or death.

### **DANGER**

**DANGER** indicates a hazardous situation which, if not avoided, **will result in** death or serious injury.

### **WARNING**

**WARNING** indicates a hazardous situation which, if not avoided, **could result in** death or serious injury.

### **CAUTION**

**CAUTION** indicates a hazardous situation which, if not avoided, **could result in** minor or moderate injury.

### **NOTICE**

**NOTICE** is used to address practices not related to physical injury.

### PLEASE NOTE

Electrical equipment should be installed, operated, serviced, and maintained only by qualified personnel. No responsibility is assumed to Schneider Electric for any consequences arising out of the use of this material.

A qualified person is one who has skills and knowledge related to the construction and operation of electrical equipment and its installation, and has received safety training to recognize and avoid the hazards involved.

### Qualification Of Personnel

Only appropriately trained persons who are familiar with and understand the contents of this manual and all other pertinent product documentation are authorized to work on and with this product. In addition, these persons must have received safety training to recognize and avoid hazards involved. These persons must have sufficient technical training, knowledge and experience and be able to foresee and detect potential hazards that may be caused by using the product, by changing the settings and by the mechanical, electrical and electronic equipment of the entire system in which the product is used. All persons working on and with the product must be fully familiar with all applicable standards, directives, and accident prevention regulations when performing such work.



## At a Glance

### Document Scope

This document gives you an overview of the available Altivar Process Drive Systems. Furthermore, you can select from the options described in detail in order to adapt the Altivar Process Drive System to the actual requirements of your system.

### Validity Note

Original instructions and information given in this manual have been written in English (before optional translation).

This documentation is valid for the Altivar Process Drive Systems.

The technical characteristics of the devices described in this document also appear online. To access this information online:

Step	Action
1	Go to the Schneider Electric home page <a href="http://www.schneider-electric.com">www.schneider-electric.com</a> .
2	In the <b>Search</b> box type the reference of a product or the name of a product range. <ul style="list-style-type: none"><li>• Do not include blank spaces in the reference or product range.</li><li>• To get information on grouping similar modules, use asterisks (*).</li></ul>
3	If you entered a reference, go to the <b>Product Datasheets</b> search results and click on the reference that interests you. If you entered the name of a product range, go to the <b>Product Ranges</b> search results and click on the product range that interests you.
4	If more than one reference appears in the <b>Products</b> search results, click on the reference that interests you.
5	Depending on the size of your screen, you may need to scroll down to see the data sheet.
6	To save or print a data sheet as a .pdf file, click <b>Download XXX product datasheet</b> .

The characteristics that are presented in this manual should be the same as those characteristics that appear online. In line with our policy of constant improvement, we may revise content over time to improve clarity and accuracy. If you see a difference between the manual and online information, use the online information as your reference.



## Related Documents

Use your tablet or your PC to quickly access detailed and comprehensive information on all our products on [www.schneider-electric.com](http://www.schneider-electric.com).

The internet site provides the information you need for products and solutions:

- The whole catalog for detailed characteristics and selection guides
- The CAD files to help design your installation, available in over 20 different file formats
- Software and firmware to maintain your drive up to date
- A large quantity of White Papers, Environment documents, Application solutions, Specifications... to gain a better understanding of our electrical systems and equipment or automation
- And finally the User Guides related to your drive, listed below:

Title of Documentation	Reference number
ATV680 Handbook	<a href="#">NHA37112</a> (German), <a href="#">NHA37113</a> (English)
Drive Systems – Installation manual	<a href="#">NHA37118</a> (German), <a href="#">NHA37119</a> (English), <a href="#">NHA37121</a> (French), <a href="#">NHA37122</a> (Spanish), <a href="#">NHA37123</a> (Italian), <a href="#">NHA37126</a> (Polish), <a href="#">NHA37127</a> (Portuguese), <a href="#">NHA37128</a> (Russian), <a href="#">NHA37129</a> (Turkish), <a href="#">NHA37130</a> (Chinese)
ATV6●● Programming manual	<a href="#">EAV64318</a> (English), <a href="#">EAV64320</a> (French), <a href="#">EAV64321</a> (German), <a href="#">EAV64322</a> (Spanish), <a href="#">EAV64323</a> (Italian), <a href="#">EAV64324</a> (Chinese)
ATV6●● Modbus serial link manual (embedded)	<a href="#">EAV64325</a> (English)
ATV6●● Ethernet manual (embedded)	<a href="#">EAV64327</a> (English)
ATV6●● Ethernet IP - Modbus TCP manual (VW3A3720, 721)	<a href="#">EAV64328</a> (English)
ATV6●● PROFIBUS DP Manual (VW3A3607)	<a href="#">EAV64329</a> (English)
ATV6●● PROFINET manual (VW3A3627)	<a href="#">EAV64331</a> (English)
ATV6●● CANopen manual (VW3A3608, 618, 628)	<a href="#">EAV64333</a> (English)
ATV6●● Communication parameters	<a href="#">EAV64332</a> (English)
ATV6●● Safety function manual	<a href="#">EAV64334</a> (English)
ATV6●● & ATV9●● ATEX manual	<a href="#">NVE42416</a> (English)
SoMove: FDT	<a href="#">SoMove_FDT</a> (English, French, German, Spanish, Italian, Chinese)
Altivar Process ATV6●● DTM	<a href="#">ATV6xx_DTM_Library_EN</a> (English), <a href="#">ATV6xx_DTM_Library_FR</a> (French), <a href="#">ATV6xx_DTM_Library_DE</a> (German), <a href="#">ATV6xx_DTM_Library_SP</a> (Spanish), <a href="#">ATV6xx_DTM_Library_IT</a> (Italian), <a href="#">ATV6xx_DTM_Library_CN</a> (Chinese),

You can download these technical publications and other technical information from our website at [www.schneider-electric.com](http://www.schneider-electric.com).

---

## Terminology

The technical terms, terminology and the corresponding descriptions in this manual are inspired by the terms or definitions in the relevant standards.

In the area of drive systems this includes, but is not limited to, terms such as **error, error message, failure, fault, fault reset, protection, safe state, safety function, warning, warning message** and so on.

Among others, these standards include:

- IEC 61800 series: Adjustable speed electrical power drive systems
- EN 61439 series: Low-voltage switchgear and controlgear assemblies
- IEC 61508, Ed. 2 series: Functional safety of electrical/electronic/programmable electronic safety-related
- EN 954-1 Safety of machinery – Safety related parts of control systems
- EN ISO 13849-1 and 2 Safety of machinery – Safety related parts of control systems
- IEC 61158 series: Industrial communication networks – Fieldbus specifications
- IEC 61784 series: Industrial communication networks – Profiles
- IEC 60204-1: Safety of machinery – Electrical equipment of machines – Part 1: General requirements

In addition, the term **zone of operation** is used in conjunction with the description of specific hazards, and is defined as it is for a **hazard zone** or **danger zone** in the EC Machinery Directive (2006/42/EC) and in ISO 12100-1.

## Contact us

Select your country on:

[www.schneider-electric.com/contact](http://www.schneider-electric.com/contact)

### Schneider Electric Industries SAS

Head Office  
35, rue Joseph Monier  
92500 Rueil-Malmaison  
France

---

# Chapter 1

## Drive Systems

---

### What Is in This Chapter?

This chapter contains the following topics:

Topic	Page
Overview	12
ATV680 – Low Harmonic Drive Systems	13
Expandability	16

Overview

<b>Market segment</b>	<b>Water and waste water</b> <b>Oil &amp; gas</b> <b>Mining, minerals &amp; metals</b> <b>Food &amp; beverage</b>
-----------------------	----------------------------------------------------------------------------------------------------------------------------



<b>Drive Systems</b>	Frequency inverter as enclosure unit for speed control of asynchronous and synchronous motors.	
<b>Brief description</b>	Enclosure unit, alternatively in the standard design, with additional adaptations or as a customized solution	Low Harmonic, alternatively in the standard design, with additional adaptations or as a customized solution
<b>Special features</b>	Compact Drive Systems with integrated line reactor to reduce the current harmonics THDi 32...48 %	Low Harmonic Drive Systems with active mains rectifier to reduce the current harmonics THDi < 5 %
<b>Protection degree</b>	IP23 standard design of the enclosure IP54 optional design of the enclosure	
<b>Power range</b>	110 / 90 up to 800 / 630 kW	
<b>Voltage ranges</b>	<ul style="list-style-type: none"> <li>● 3 AC 380 V -10 % ... 415 V +6 %</li> <li>● 3 AC 400 V -10 % ... 415 V +10 %</li> </ul>	<ul style="list-style-type: none"> <li>● 3 AC 440 V ±10 %</li> <li>● 3 AC 480 V ±10 %</li> </ul>
<b>Mains frequency</b>	50/60 Hz +/- 5 %	
<b>Output frequency</b>	0.1...500 Hz	
<b>Control method</b>	Asynchronous motor: Variable load torque, constant load torque, energy saving Synchronous motor: PM (permanent magnet) motor	
<b>Interfaces</b>	Operating panel in the enclosure door, control terminals inside the enclosure, control terminals can be extended, fieldbus connection via Ethernet or Modbus, saving the parameters via USB interface at the keypad	
<b>References</b>	<b>ATV660●●●●●X1</b>	<b>ATV680●●●●●X1</b>
<b>Further reading</b>	You can find detailed information in the "Altivar Process ATV660 Handbook" and on <a href="http://www.schneider-electric.com">www.schneider-electric.com</a> .	You will find detailed information in this document.

## ATV680 – Low Harmonic Drive Systems

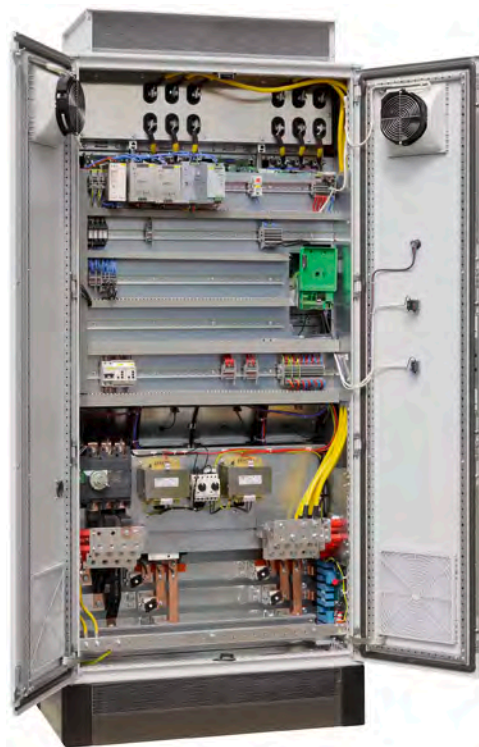

Low Harmonic Drive Systems as enclosure unit for speed control of asynchronous and synchronous motors.

### Concept

The ATV680 Low Harmonic Drive Systems are used when drives should contain mains harmonics particularly low.

In comparison with the classic circuit structure of active mains rectifiers, the 3-level technology allows an increase of the switching frequency and the current load is reduced at the same time. This new technology reaches a total distortion factor THD(i) of around 2 % and thus fulfills the requirements according to IEEE 519 of  $\text{THD}(i) < 5\%$  also in case of distorted mains. Additionally, the  $\cos \Phi \approx 1$  in each load situation helps to reduce the load of the mains.

The modular construction makes it possible to adapt the enclosure unit to the individual requests. It makes the planning easy and allows a quick installation and commissioning of the drive.

### Basic equipment

The basic equipment contains active infeed modules and their filter components as well as frequency inverter modules, semiconductor fuses, a main switch, a dv/dt filter choke (from 200 kW) for protection of the motor and spacious mains and motor bars for connection of the power cables. The design is based on the standard enclosure system Spacial SF with an graphical operating panel integrated into the enclosure door.

The control is located on a spacious control panel. It provides compact dimensions, nevertheless it is enough space for additional extensions and accessibility in case of maintenance.

## Device features

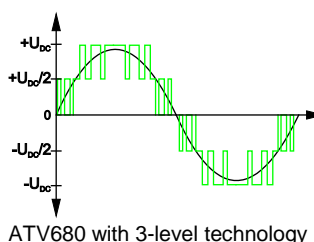
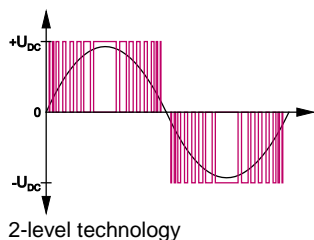

### Enhanced motor lifetime due to 3-level concept

The 3-level technology of the active mains rectifier reduces the voltage load at the motor significantly compared to other Low Harmonic frequency inverters. The gliding adaptation of the DC link voltage makes a major contribution to extend the motor lifetime.

### Reduced losses by 3-level concept

In comparison with the classic circuit structure of active mains rectifiers, the switching frequency is increased and the current load is reduced at the same time when using 3-level technology. So the losses of the whole system are significantly reduced.

### Compact dimensions due to 3-level concept

A significant advantage of the 3-level technology becomes clear when considering the dimensions of the integrated filter components. Due to the increased switching frequency and the location inside the forced cooling air channel, the dimensions of the filter could be almost halved.

Enclosure Design 400 V

ATV680 - General technical data			
Mains voltage	<ul style="list-style-type: none"> <li>● 3 AC 380 V -10 % ... 415 V +6 %</li> <li>● 3 AC 400 V -10 % ... 415 V +10 %</li> <li>● 3 AC 440 V ±10 %</li> <li>● 3 AC 480 V ±10 %</li> </ul> <p>50/60 Hz ±5 % for TT, TN-C or TN-S Other voltages and mains topologies on request.</p>		
Maximum current	<p>Normal duty (ND): 110 % for 60 s per 10 minutes Heavy duty (HD): 150 % for 60 s per 10 minutes</p>		
Ambient temperature	<p>-10...+50 °C (below 0 °C with additional enclosure heating, above +40 °C with derating) You will find further information at chapter "Maximum Ambient Temperature", page 35.</p>		
Standard equipment	<p>Enclosure system Spacial SF in RAL 7035, protection degree IP23, graphical operating panel in the enclosure door, Low Harmonic Drive System with active mains rectifier to reduce the current harmonics THDi &lt; 5 %, mains and motor terminals, cable entry from bottom</p>		
Interfaces	<p>Pluggable control terminals, fieldbus connection via Ethernet or Modbus</p>		
Possible customizations	<table border="0" style="width: 100%;"> <tr> <td style="vertical-align: top; width: 50%;"> <ul style="list-style-type: none"> <li>● Increased protection degree IP54</li> <li>● Enclosure plinth for basic device</li> <li>● Connection enclosure cable from top/bottom</li> <li>● Enclosure lighting</li> <li>● Enclosure heating</li> <li>● Key switch "local/remote"</li> <li>● Ethernet port on front door</li> <li>● Digital and analog I/O card</li> <li>● Relay output card</li> <li>● Communication cards for various fieldbus systems</li> <li>● STO - SIL 3 Stop category 0 or 1</li> <li>● Front display module (FDM)</li> <li>● Modified wiring colors</li> <li>● Remote monitoring</li> <li>● Seaworthy packaging</li> <li>● Differing mains voltages</li> <li>● Design without main switch</li> </ul> </td> <td style="vertical-align: top; width: 50%;"> <ul style="list-style-type: none"> <li>● Increased short-circuit strength (100 kA)</li> <li>● Indicator lamps on front door</li> <li>● Motor temperature monitoring</li> <li>● Bearing temperature monitoring</li> <li>● dv/dt filter choke</li> <li>● Motor heating</li> <li>● Circuit breaker</li> <li>● Undervoltage coil for circuit breaker 230 V</li> <li>● Motor for circuit breaker 230 V</li> <li>● Safety labels in local language</li> <li>● Air intake from back</li> <li>● Differing enclosure colors</li> <li>● Customized documentation</li> <li>● Customized labeling</li> <li>● Design for IT mains</li> <li>● Motor contactor</li> <li>● ...</li> </ul> </td> </tr> </table>	<ul style="list-style-type: none"> <li>● Increased protection degree IP54</li> <li>● Enclosure plinth for basic device</li> <li>● Connection enclosure cable from top/bottom</li> <li>● Enclosure lighting</li> <li>● Enclosure heating</li> <li>● Key switch "local/remote"</li> <li>● Ethernet port on front door</li> <li>● Digital and analog I/O card</li> <li>● Relay output card</li> <li>● Communication cards for various fieldbus systems</li> <li>● STO - SIL 3 Stop category 0 or 1</li> <li>● Front display module (FDM)</li> <li>● Modified wiring colors</li> <li>● Remote monitoring</li> <li>● Seaworthy packaging</li> <li>● Differing mains voltages</li> <li>● Design without main switch</li> </ul>	<ul style="list-style-type: none"> <li>● Increased short-circuit strength (100 kA)</li> <li>● Indicator lamps on front door</li> <li>● Motor temperature monitoring</li> <li>● Bearing temperature monitoring</li> <li>● dv/dt filter choke</li> <li>● Motor heating</li> <li>● Circuit breaker</li> <li>● Undervoltage coil for circuit breaker 230 V</li> <li>● Motor for circuit breaker 230 V</li> <li>● Safety labels in local language</li> <li>● Air intake from back</li> <li>● Differing enclosure colors</li> <li>● Customized documentation</li> <li>● Customized labeling</li> <li>● Design for IT mains</li> <li>● Motor contactor</li> <li>● ...</li> </ul>
<ul style="list-style-type: none"> <li>● Increased protection degree IP54</li> <li>● Enclosure plinth for basic device</li> <li>● Connection enclosure cable from top/bottom</li> <li>● Enclosure lighting</li> <li>● Enclosure heating</li> <li>● Key switch "local/remote"</li> <li>● Ethernet port on front door</li> <li>● Digital and analog I/O card</li> <li>● Relay output card</li> <li>● Communication cards for various fieldbus systems</li> <li>● STO - SIL 3 Stop category 0 or 1</li> <li>● Front display module (FDM)</li> <li>● Modified wiring colors</li> <li>● Remote monitoring</li> <li>● Seaworthy packaging</li> <li>● Differing mains voltages</li> <li>● Design without main switch</li> </ul>	<ul style="list-style-type: none"> <li>● Increased short-circuit strength (100 kA)</li> <li>● Indicator lamps on front door</li> <li>● Motor temperature monitoring</li> <li>● Bearing temperature monitoring</li> <li>● dv/dt filter choke</li> <li>● Motor heating</li> <li>● Circuit breaker</li> <li>● Undervoltage coil for circuit breaker 230 V</li> <li>● Motor for circuit breaker 230 V</li> <li>● Safety labels in local language</li> <li>● Air intake from back</li> <li>● Differing enclosure colors</li> <li>● Customized documentation</li> <li>● Customized labeling</li> <li>● Design for IT mains</li> <li>● Motor contactor</li> <li>● ...</li> </ul>		
Standards	<p>CE, EAC, RCM, ATEX, IEEE 519 (THDi &lt; 5 %), RFI filter for second "industrial environment" C3 integrated</p>		

Type	Size	Motor rating (ND / HD)	Output current (ND / HD)	Dimensions		
				Width	Depth <sup>(1)</sup>	Height
ATV680C11●4X1	1a	110 kW / 90 kW	211 A / 173 A	600 mm	600 mm	2150 mm
ATV680C13●4X1		132 kW / 110 kW	250 A / 211 A	600 mm	600 mm	2150 mm
ATV680C16●4X1		160 kW / 132 kW	302 A / 250 A	600 mm	600 mm	2150 mm
ATV680C20●4X1	2a	200 kW / 160 kW	370 A / 302 A	1000 mm	600 mm	2150 mm
ATV680C25●4X1		250 kW / 200 kW	477 A / 370 A	1000 mm	600 mm	2150 mm
ATV680C31●4X1		315 kW / 250 kW	590 A / 477 A	1000 mm	600 mm	2150 mm
ATV680C35●4X1	3a	355 kW / 280 kW	660 A / 520 A	1600 mm	600 mm	2150 mm
ATV680C40●4X1		400 kW / 315 kW	730 A / 590 A	1600 mm	600 mm	2150 mm
ATV680C45●4X1		450 kW / 355 kW	830 A / 660 A	1600 mm	600 mm	2150 mm
ATV680C50●4X1		500 kW / 400 kW	900 A / 730 A	1600 mm	600 mm	2150 mm
ATV680C56●4X1	4a	560 kW / 450 kW	1020 A / 830 A	2000 mm	600 mm	2150 mm
ATV680C63●4X1		630 kW / 500 kW	1140 A / 900 A	2000 mm	600 mm	2150 mm
ATV680C71●4X1	5a	710 kW / 560 kW	1260 A / 1020 A	2600 mm	600 mm	2150 mm
ATV680C80●4X1		800 kW / 630 kW	1420 A / 1140 A	2600 mm	600 mm	2150 mm
<b>(1)</b> Total depth including door handle and switch handle: 664 mm						

## Expandability

The new Altivar Process Drive Systems are the result of our many years of experience in the field of electronic drives. Moreover we provide especially designed expansion options for a various range of applications. Our worldwide, certified manufacturing sites and the local engineering teams allow a global offer.

## Predefined Customizations



Due to the predefined customizations the Altivar Process Drive System can be adapted easily and quick to the customer requirements. Besides, this allows minimal delivery time for an individually adapted enclosure ready to connect.

Certainly the Altivar Process Drive Systems can be ordered also in the basic design, which is already extensive equipped, without any customization.

Predefined customizations are:

- Increased protection degree IP54
- Enclosure plinth for basic device
- Connection enclosure cable from top/bottom
- Enclosure lighting
- Enclosure heating
- Key switch "local/remote"
- Ethernet port on front door
- Digital and analog I/O card
- Relay output card
- Communication cards for various fieldbus systems
- STO - SIL 3 Stop category 0 or 1
- Indicator lamps on front door
- Motor temperature monitoring
- Bearing temperature monitoring
- dv/dt filter choke
- Motor heating
- Circuit breaker
- Undervoltage coil for circuit breaker
- Motor for circuit breaker 230 V
- Safety labels in local language
- Modified wiring colors
- Remote monitoring
- Seaworthy packaging
- Differing mains voltages
- Design without main switch
- Increased short-circuit strength (100 kA)
- Air intake from back
- Differing enclosure colors
- Customized documentation
- Customized labeling
- Design for IT mains
- Motor contactor
- Integrated control functions
- ...

## Individual Customizations



Due to our substantial know-how and the high flexibility in performing projects, it is possible to realize unique system solutions. They are individually adapted to the customers demands.

Typical customizations:

- Multi drives (several frequency inverters in an enclosure composition)
- Differing cooling system
- Different enclosure system
- Differing dimensions
- ...



## Type designation

The type designation of the Altivar Process Drive Systems consists of several points of signs (characters and figures). The meaning of each point is illustrated in the following example.

		ATV	680	C16	Q4	X1
<b>Product</b>	<b>Description</b>					
ATV	Altivar					
<b>oSegments</b>						
680	Low Harmonic Drive Systems					
<b>Drive power</b>						
C11...C80	110 / 90 kW ... 800 / 630 kW					
<b>Mains voltage</b>						
Q4	3 AC 380 V -10 %...415 V +6 % (+10 %)					
R4	3 AC 440 V ±10 %					
T4	3 AC 480 V ±10 %					
<b>Design variant</b>						
X1	Europe CE					



---

# Chapter 2

## General Specification

---

### What Is in This Chapter?

This chapter contains the following topics:

Topic	Page
Quality	20
Mains Conditions	24
Protection of the Plant	27

## Quality

Altivar frequency inverters use modern components and solutions for the control of asynchronous three-phase motors and synchronous three-phase motors. This enables an extremely compact design and user-friendly device features.

The ATV680 includes an active input bridge and leads a sinusoidal mains current. So it is an alternative to active and passive filters.

State-of-the-art components, a new control concept as well as a top-quality filter module reduce the total harmonic distortion THD(i) of the frequency inverter to a value less than 2...5 % and by this way it fulfills the requirements according to the recommendations in IEEE 519 to reduce the current harmonics in the mains.

Also in case of operation with partial load (from 30 %  $P_n$ ) the ATV680 leads a sinusoidal mains current with a power factor  $\cos \Phi \approx 1$ .

Our high degree of quality awareness ranges from the basic requests in the product specification over the development of the cooling system, of the mechanical design, of the electrical circuit diagram and the individual functions up to the production of the device. This process quality level is also long-term guaranteed by means of the corresponding quality assurance systems in the individual business processes and is certified every year by independent authorities according to DIN EN ISO 9001.

The Altivar Process Drive Systems fulfil the relevant international standards and regulations.

## System concept ATV680

Altivar Process Drive Systems are manufactured according to the selected design (basic device and options) and are delivered as a drive unit ready to connect. They include the functionally necessary components.

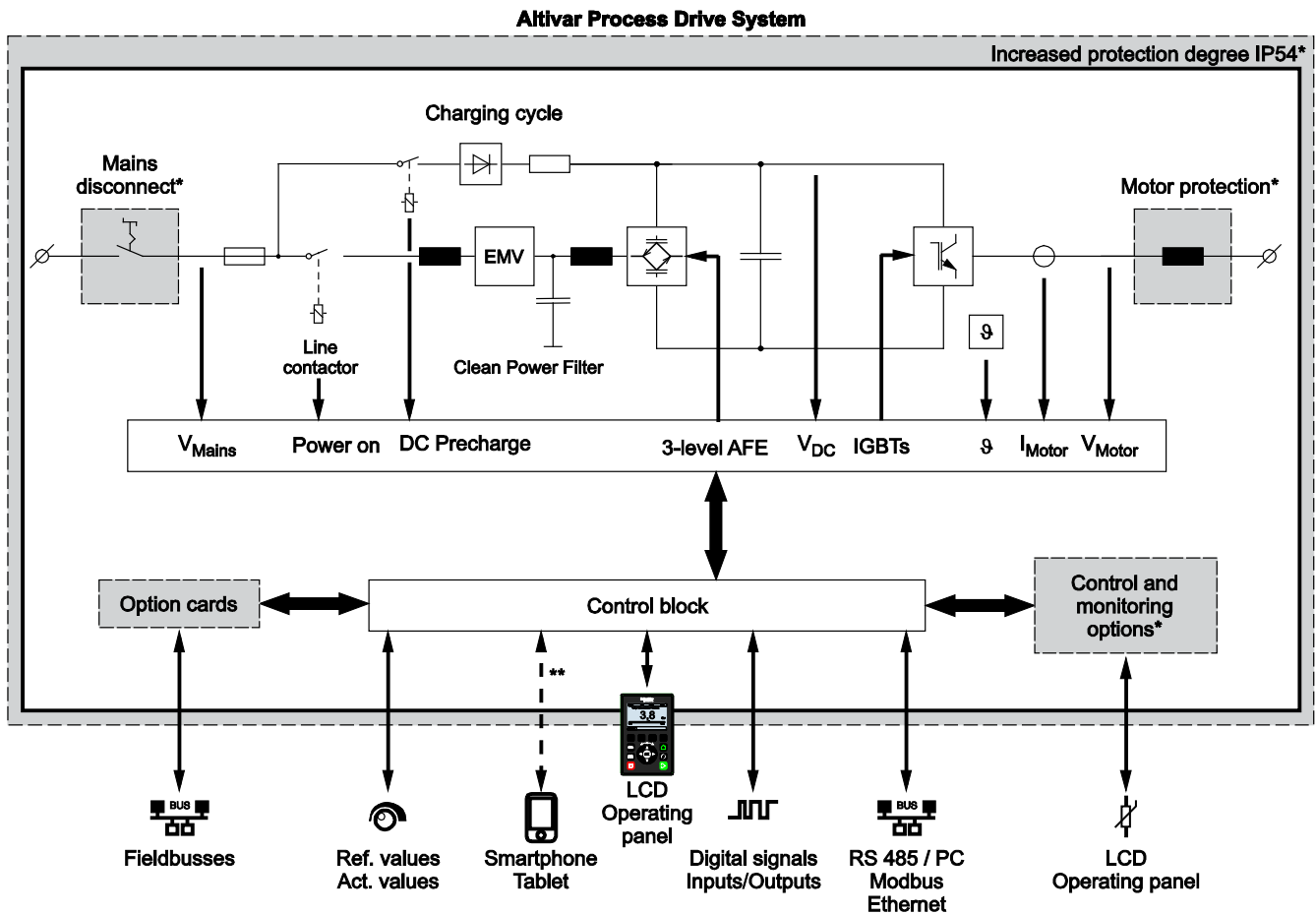

\* Optionally selectable

\*\* With optional WIFI module (TCSEGWB13FA0)

Depending on the local conditions and the requests on the drive the basic design can be supplemented by options. Options for the power path, options for control and operation as well as mechanical options are available. They are all integrated into the enclosure unit but they may cause a change of dimensions.

## CE Marking

The frequency inverters have a CE marking on the rating plate. However, to achieve the corresponding limits it is necessary to observe the installation regulations, superior and regional standards and directives as well as the directives listed below.

All devices and drives of the electric drive engineering may cause electromagnetic interferences and otherwise they may be influenced by such interferences. Therefore, they are subject to the **EMC directive 2004/108/EC**.

The frequency inverters have an operating voltage which is clearly in the range of 50...1000 V AC or 75...1500 V DC. Therefore, they are also subject to the **Low Voltage Directive 2006/95/EC**.

Because of the EMC filters which are built into the frequency inverters they are in conformity with **EN 61800-3** and **EN 61800-5-1**.

Frequency inverters are not considered as stand-alone machines according to the Machinery Directive 2006/42/EC. They have to be accounted as component of the closed functional safety system.

This product meets the EMC requirements according to the standard IEC 61800-3 if the measures described in this manual are implemented during installation.

If the selected composition (product itself, mains filter, other accessories and measures) does not meet the requirements of category C1, the following information applies as it appears in IEC 61800-3:

<b>⚠ WARNING</b>
<b>RADIO INTERFERENCE</b>
In a domestic environment this product may cause radio interference in which case supplementary mitigation measures may be required.
<b>Failure to follow these instructions can result in death, serious injury, or equipment damage.</b>

## Installation Regulations

- The frequency inverters have a RFI filter for grounded mains built-in.
- Take care of good HF connection between motor cable screen and filter.
- Use of shielded motor cables, proper connection of the motor cables on both ends or proper laying in a metallic, closed and interconnected cable conduit
- In case of high motor cable lengths a corresponding dv/dt filter choke is required.
- Use shielded control cables and connect them correctly.
- Ground the frequency inverter for human protection.
- Consider the protective separation (PELV) when preparing signal wires and coupling relays.
- Lay the motor cables separate from other cables, especially from the signal wires.

**NOTE:** Further information is given in the installation manual.

## Safety of Machinery

For the functional safety and stop categories the function "Safe Torque Off (STO)" has been integrated. So an optimal adaptation of the drive to the required safety category for the machine is possible.

**NOTE:** You will find further information about this function in chapter "Safe Torque Off (STO)", page 102.

For all selectable safety options the implementation of external safety-relevant contacts is provided. So the Altivar Process does not act as a closed functional safety system in terms of the Machine directive and safety standards EN/IEC 61508, ISO 13849-1 and NF EN 62061. It has to be accounted as component in any case.

**EMC Product Standard for PDS (Power Drive Systems) EN 61800-3**

For frequency inverter drives the product standard EN/IEC 61800-3 edition 1 and 2 appeared. It has first priority over the existing general standards (generic standards). If a drive is installed into another device for which a separate EMC product standard exists, then this standard applies.

The aim of the **EMC directive 2004/108/EEC** is the ability of electric and electronic installations to operate satisfactorily in their electromagnetic environment without influencing the environment or other loads therein.

Therefore, the PDS product standard contains both limits for admissible interferences and requirements for the necessary interference resistance.

The power drive standard EN 61800-3 covers the complete drive from the mains supply to the motor shaft.

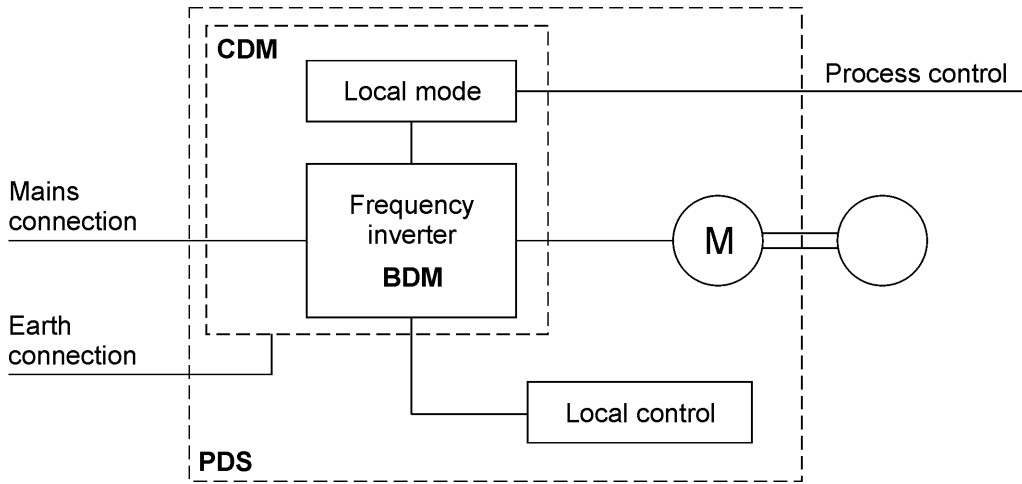

- BDM: Base-Drive-Module**      Basic drive consisting of the power part and the control electronics (e.g. frequency inverter - built-in unit)
- CDM: Complete-Drive-Module**      Drive modules consisting of BDM (basic drive) and extensions, if existing (e.g. enclosure including main switch, circuit breaker, line contactor, filter components, power terminals, ...)
- PDS: Power-Drive-System**      Drive system consisting of CDM (drive module) and motor, motor cable, local control, power transformer, ... (e.g. the complete electric drive of a machine)

The differentiation in respect of the sales method and the range of use is essential for the handling of frequency inverters.

### Use In Industrial Environment

The standard refers to these application areas as "second environment". These are areas which are separated from the public mains by means of an own transformer.

The user has to take care that the suppression components recommended by the manufacturer are used and that the introductions of the manufacturer are observed. Moreover, the user has to take care that strong interferences do not couple into neighboring low-voltage mains.

If the neighboring mains is a public mains with residential areas, the limits 66-56/56/60 dB(μV) quasi-peak apply. In case of industrial mains the higher limits 79/73/73 dB(μV) quasi-peak can be used.

Furthermore, it is necessary to enhance the suppression of interferences if other devices are influenced. The operator of the plant is responsible for this improvement.

The limits for immunity are much stricter because they are based on a generally higher level of interferences.

### Category C3

Use in industrial environments

Limits for interferences	Line-conducted interferences	Radiation
For drives with a size ≤ 100 A the admissible limits for interferences are 100/86/90-70 dB(μV) quasi-peak and 50/60 dB(μV/m) at a distance of 10 m (class A group 2).	<p><b>dBμV (QP)</b></p> <p>0.15 0.5 5 30 MHz</p>	<p><b>dBμV/m (QP)</b></p> <p>30 230 1000 MHz</p>
For drives with a size > 100 A the admissible limits for interferences are 130/125/115 dB(μV) quasi-peak and 50/60 dB(μV/m) at a distance of 10 m (class A group 2).	<p><b>dBμV (QP)</b></p> <p>0.15 0.5 5 30 MHz</p>	<p><b>dBμV/m (QP)</b></p> <p>30 230 1000 MHz</p>

### Category C4

Use in industrial environments for drives > 1000 V or > 400 A

For these drives are no limits defined. An EMC concept has to be compiled within project planning.

### IT mains

In case of non-grounded mains it is usually not possible to keep the limits. Filter capacitors make detection of insulation faults difficult and thus they interfere with the concept of a floating power supply. However, filters that are developed especially for IT mains can be used because they also cause a high reduction of the conducted interferences in non-grounded mains.

**NOTE:** The basic requirements for compliance with the relevant limits are the observance and compliance of the installation requirements and a correct customization of the Drive System.

## Mains Conditions

### Mains Voltage

The Altivar Process Drive Systems are designed for standard industrial mains TT and TN with following mains voltage:

- 3 AC 380 V -10 % ... 415 V +6 %
- 3 AC 400 V -10 % ... 415 V +10 %
- 3 AC 440 V ±10 %
- 3 AC 480 V ±10 %

**NOTE:** Other voltages and the use in IT mains or "Corner grounded networks" are available on request.

The mains voltage must comply with the requirements according to IEC 60038 and EN 50160:

- Unbalance between phases: < 2 %
- Total harmonic factor THD(v): < 10 %
- Maximum single harmonic: < 5 %

**NOTICE**

**DESTRUCTION DUE TO INCORRECT MAINS VOLTAGE**

Before switching on and configuring the product, verify that it is approved for the mains voltage.  
**Failure to follow these instructions can result in equipment damage.**

### Undervoltage behavior

In case of short-time mains voltage drops outside the specified tolerance, operation is still possible.

If the mains voltage does not return within the specified time, an undervoltage shut-down occurs.

Mains undervoltage	Restriction
-10 % of nominal voltage	Starting the drive and continuous operation possible <sup>(1)</sup>
-15 % of nominal voltage	Starting the drive and operation <sup>(1)</sup> for 10 s per 100 s possible
-20 % of nominal voltage	Operation <sup>(1)</sup> for less than 1 s possible
-30 % of nominal voltage	Operation <sup>(1)</sup> for less than 0.5 s possible
<b>(1)</b> With nominal current	

### Non-grounded Mains

The Altivar Process Drive Systems can be prepared for the use in non-grounded mains (IT mains or "Corner grounded networks").



## Radio Interferences

The Altivar Process Drive Systems include a radio frequency interference filter as standard. This filter fulfils the requirements for category "C3 – industrial environments" according to EN/IEC 61800-3 (in the past: EN 55011 class A group 2).

This product meets the EMC requirements according to the standard IEC 61800-3 if the measures described in this manual are implemented during installation.

If the selected composition (product itself, mains filter, other accessories and measures) does not meet the requirements of category C1, the following information applies as it appears in IEC 61800-3:

 <b>WARNING</b>
<b>RADIO INTERFERENCE</b>
In a domestic environment this product may cause radio interference in which case supplementary mitigation measures may be required.
<b>Failure to follow these instructions can result in death, serious injury, or equipment damage.</b>

## Mains Impedance / Short-circuit Current

The Altivar Process Drive Systems are designed considering a maximal and minimal permitted mains short-circuit current of the supply (values see "Technical data" of the respective frequency inverter).

These frequency inverters can be designed for higher mains short-circuit currents on request. You will find information about the short-circuit protection at chapter "Mains Connection", page 65.

## Switching Rate

Altivar Process Drive Systems are equipped with a main switch for disconnecting the applied mains voltage.

In case of frequent start/stop requests it is recommended to realize them by means of the digital control inputs (or via a serial bus) directly to the electronics of the inverter.

Optionally the mains separation can be realized by a circuit breaker with motor.

**NOTE:** By means of the certificated control inputs  $\overline{\text{STOA}}$  and  $\overline{\text{STOB}}$  a "Safe Torque Off" of the drive is considering the safety category according to ISO 13849-1 (and IEC/EN 61800-5-2). Disconnecting the mains supply or the motor is therefore not required.

Inverter control	Switching rate ATV680
Mains voltage switched external	Max. 60 switching operations per hour
Mains voltage switched internal: <ul style="list-style-type: none"> <li>● Main switch (standard)</li> <li>● Circuit breaker (option)</li> <li>● Circuit breaker with motor (option)</li> </ul>	Max. 10 switching operations per hour Max. 10,000 switching operations total
Start / Stop requests via digital inputs with active energy saving function "Stop and Go" <sup>(1)</sup>	Max. 60 switching operations per hour
Start / Stop requests via digital inputs without energy saving function "Stop and Go" <sup>(1)</sup>	Arbitrary
Release / Lock via STO inputs with active energy saving function "Stop and Go" <sup>(1)</sup>	Max. 60 switching operations per hour
Release / Lock via STO inputs without energy saving function "Stop and Go" <sup>(1)</sup>	Arbitrary
<b>(1)</b> The energy saving function "Stop and Go" is activated by default.	

**NOTE:** The device fans are automatically controlled depending on the start/stop request.

If the power stage is disabled unintentionally, for example, as a result of power outage, errors or functions, there is a possibility that the motor is no longer decelerated in a controlled way.

 **WARNING**

**UNANTICIPATED EQUIPMENT OPERATION**

Verify that movements without braking effect does not result in unsafe conditions.

**Failure to follow these instructions can result in death, serious injury, or equipment damage.**

## Protection of the Plant

### Responsibility

All stated connection recommendations and planning remarks are to be taken merely as suggestions which must be adapted to the local conditions and regulations concerning installation and usage.

This applies especially to the functional safety regulations for machines, the EMC regulations and the general regulations for human protection.

### Installation Site

Altivar Process Drive Systems are qualified for vertical installation in electrical operating rooms as well as in the area of production facilities.

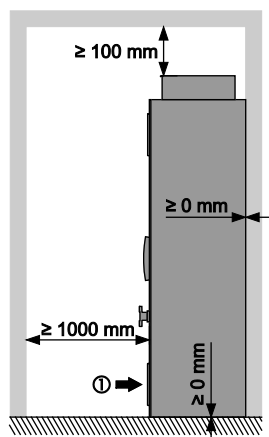

- Observe the specified minimum distances. Mounting the Drive Systems side by side or back to back is allowed.
- Install the Altivar Process Drive System vertically on a non-combustible, solid and vibration-free ground.
- Take care of compliance with the ambient conditions.
- Take care that the air exchange is sufficient for dissipation of the lost heat during operation.

① Air inflow temperature: -10...+50 °C (14...122 °F)  
(below 0 °C (32 °F) with additional enclosure heating,  
above +40 °C (104 °F) with derating)

**NOTE:** At enclosure design IP54 the ATV680 frequency inverter is qualified for pollution degree 3 according to EN 61800-5-1.

**NOTE:** Further information is given in the installation manual.

This equipment has been designed to operate outside of any hazardous location. Only install this equipment in zones known to be free of hazardous atmosphere.

## **⚠ DANGER**

### **POTENTIAL FOR EXPLOSION**

Install and use this equipment in non-hazardous locations only.

**Failure to follow these instructions will result in death or serious injury.**

### Increased Motor Speed

With the Altivar Process Drive Systems it is possible to control the rotational speed of motors from 0.1...500 Hz.

### Overvoltage Protective Circuit

The AC and DC control circuits must be protected against overvoltage.

Use flyback diodes for DC control circuits.

For AC control circuits, RC circuits are advisable because they can reduce the peak overvoltage and the rise time while varistors only reduce the peak voltage.

<b>NOTICE</b>
<b>INOPERATIVE CONTROL CIRCUITS</b> Verify that all inductances such as relays, contactors, external brakes, etc. are equipped with appropriate overvoltage protection circuits. <b>Failure to follow these instructions can result in equipment damage.</b>

### Residual Current Circuit Breaker

Frequency inverters, especially those with additional EMC filters and shielded motor cables, lead an increased leakage current against ground.

The leakage current depends on:

- The length of the motor cable
- The type of laying and whether the motor cable is shielded or not
- The set pulse frequency
- The use of an additional radio frequency interference filter
- The grounding of the motor at its installation place (grounded or non-grounded)

Depending on the conditions, the leakage current of plants with high cable lengths can be absolutely higher than 100 mA !

The built-in residual current detection has no current-limiting effect. It only helps to protect the drive and is no human protection.

Particularly because of the capacitors of the radio frequency interference filter, an unintentional triggering of a residual current circuit breaker may occur at the moment of switching on. As well, the ground capacitances may cause an incorrect triggering during operation. On the other hand, it is possible that the triggering is blocked by means of DC components which are caused by the mains rectification at the input of the inverter.

Direct current can be introduced in the protective ground conductor of this drive. If a residual current device (RCD / GFCI) or a residual current monitor (RCM) is used for additional protection against direct or indirect contact, the following specific types must be used:

<b>⚠ WARNING</b>
<b>DIRECT CURRENT CAN BE INTRODUCED INTO THE PROTECTIVE GROUND CONDUCTOR</b> Use a Type B Residual Current Device (RCD / GFCI) or a Residual Current Monitor (RCM) that has approval for use with frequency inverters and is sensitive to all types of current. <b>Failure to follow these instructions can result in death, serious injury, or equipment damage.</b>

Further conditions for use of a residual current device:

- The drive has an increased leakage current at the moment power is applied. Use a residual current device (RCD / GFCI) or a residual current monitor (RCM) with a response delay.
- High-frequency currents must be filtered.

**NOTE:** Protect the other loads by means of a separate residual current circuit breaker.

## Automatic Restarting

This function increases the availability, especially for drives that are not integrated into the plant control via a fieldbus system. Depending on the parameterization, the frequency inverter can automatically start-up again after each mains switch-on or mains recurrence.

## Locking of the Frequency Inverter

Altivar Process Drive Systems include the standard protective function "Safe Torque Off (STO)", which helps to prevent any unintended start-up of the motor. This function fulfills, when correctly wired, the machine standard ISO 13849-1 Performance level PL e, the IEC/EN 61508 Safety integrity level SIL 3 standard for functional safety and the power drive system standard IEC/EN 61800-5-2.

**NOTE:** You will find further information in the Safety Function Manual ([EAV64334](#)).

The safety function STO (Safe Torque Off) does not remove power from the DC bus. The safety function STO only removes power to the motor. The DC bus voltage and the mains voltage to the drive are still present.

### DANGER

#### HAZARD OF ELECTRIC SHOCK

- Do not use the safety function STO for any other purposes than its intended function.
- Use an appropriate switch, that is not part of the circuit of the safety function STO, to disconnect the drive from the mains power.

**Failure to follow these instructions will result in death or serious injury.**

When the safety function STO is triggered, the power stage is immediately disabled. In the case of vertical applications or external forces acting on the motor shaft, you may have to take additional measures to bring the motor to a standstill and to keep it at a standstill when the safety function STO is used, for example, by using a service brake.

### WARNING

#### INSUFFICIENT DECELERATION OR UNINTENDED EQUIPMENT OPERATION

- Verify that using the safety function STO does not result in unsafe conditions.
- If standstill is required in your application, ensure that the motor comes to a secure standstill when the safety function STO is used.

**Failure to follow these instructions can result in death, serious injury, or equipment damage.**

## Stop and Go Function



All Altivar Process Drive Systems include the energy saving function "Stop and Go". When the frequency inverter gets a stop or lock request, the own consumption is clearly decreased by reducing the DC link voltage. With the next start request the DC link is charged and the motor can start-up again.

**NOTE:** For applications where a start delay of 1...2 s is undesired, this energy saving function can be also deactivated.

### Connecting and Disconnecting the Motor

Alternatively to the use of the control terminal STO "Safe Torque Off" a safety switch or a motor contactor can be installed to connect and disconnect the motor – Design on request.

After connection the motor restarts by means of the function "Catch on the fly".

### Multi-motor Operation

With Altivar Process Drive Systems it is possible to operate several motors at one output.

For pumps (centrifugal pumps) and fan applications, however, observe the following:

- The sum of the nominal currents has to be less than the nominal current of the inverter.
- A different speed control is not possible.
- The total motor cable length has to be taken into consideration.
- No high starting torque is available.
- The inverter does not provide individual motor overload protection.
- Autotuning is not possible (but also not necessary).
- Activation of individual motors is only permitted when the starting current remains less than the maximum inverter current.

### Operation of ATEX Motors

If you want to operate an explosion-protected motor (ATEX) with this drive system, you must use the option "Motor monitoring PTC with ATEX certificate".

**NOTE:** You will find further information about the operation of ATEX motors in the ATEX manual ([NVE42416](#)).

This equipment has been designed to operate outside of any hazardous location. Only install this equipment in zones known to be free of hazardous atmosphere.

## DANGER

### POTENTIAL FOR EXPLOSION

Install and use this equipment in non-hazardous locations only.

**Failure to follow these instructions will result in death or serious injury.**

---

# Chapter 3

## ATV680●●●●4X1

---

### What Is in This Chapter?

This chapter contains the following topics:

Topic	Page
Description	32
Specification	36
Circuit Diagram	64
Mains Connection	65
Motor Connection	68
Customizations	75

## Description

### ATV680 Frequency Inverter in Enclosure Design for 400 V Mains

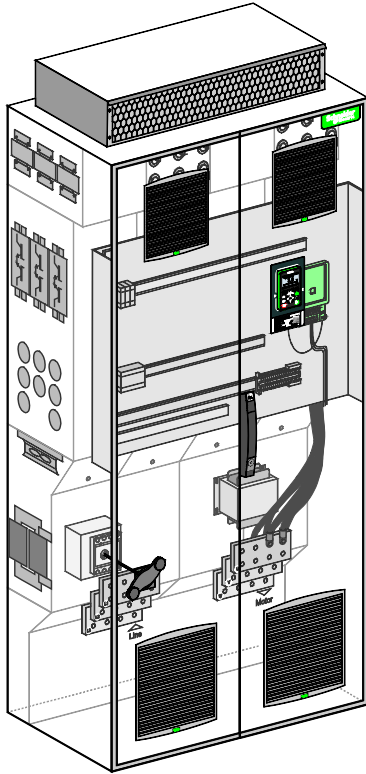

#### Power components:

- Mains connection terminals
- Main switch
- Semiconductor fuses
- Clean power filter with EMC filter
- Active Front End module(s)
- Inverter module(s)
- dv/dt filter choke(s) (optional at size 1a)
- Terminals for motor connection

#### Design:

- Floor-standing enclosure
- Integrated control panel
- Protection degree IP23
- Forced cooling
- -10...+50 °C  
(below 0 °C with additional enclosure heating,  
above +40 °C with derating)
- Graphical operating panel in the enclosure door

#### Scope of delivery:

- ATV680 Low Harmonic Drive System
- Multilingual instructions
- Documentation-CD-ROM with parameterization instructions, fieldbus instructions, operating and parameterizing software, ...
- Enclosure layout plans consisting of circuit diagram, terminal connection table, list of materials and design drawing
- Transport packaging



## General Technical Data

<b>Input</b>	
Rated voltage $U_n$	for TT, TN-C or TN-S: <ul style="list-style-type: none"> <li>• 3 AC 380 V -10 % ... 415 V +6 %</li> <li>• 3 AC 400 V -10 % ... 415 V +10 %</li> <li>• 3 AC 440 V <math>\pm</math>10 %</li> <li>• 3 AC 480 V <math>\pm</math>10 %</li> </ul> Other voltages and mains topologies on request.
Rated frequency $f_n$	50 / 60 Hz $\pm$ 5 %
Total harmonic distortion	$\leq$ 5 % (at nominal load and sinusoidal mains voltage)
Power factor cos Phi	$>$ 0.99 (at 30...120 % load)
Overvoltage category	Category III according to EN 50178
<b>Output</b>	
Control method	Asynchronous motor: Variable load torque, constant load torque, energy saving Synchronous motor: PM (permanent magnet) motor
Voltage	3 AC 0...100 % mains voltage
Overload	Normal Duty (ND): 110 % for 60 s per 10 minutes Heavy Duty (HD): 150 % for 60 s per 10 minutes
Pulse frequency	2.5 kHz, adjustable from 2...8 kHz
Frequency	0.1...500 Hz
Short-circuit protection	Short-circuits and ground faults are handled by overcurrent function and switch-off the output.
Speed accuracy	V/f mode: slip frequency VC without feedback: 0.3 x slip frequency
<b>Mechanical strength</b>	
Mechanical vibrations	According to IEC/EN 60068-2-6 1.5 mm at 3...10 Hz, 0.6 g at 10...200 Hz (3M3 according to IEC/EN 60721-3-3)
Mechanical shock	According to IEC/EN 60068-2-27 4 g for 11 ms (3M2 according to IEC/EN 60721-3-3)
<b>Ambient conditions</b>	
Ambient temperature	-10...+50 °C (below 0 °C with additional enclosure heating, above +40 °C with derating) 3K3 according to IEC/EN 60721-3-3
Storage / Transport temperature	-25...+70 °C
Protection degree	Door closed: IP23 (optionally enclosure design IP54) Door open: IP2x
Environmental class / Humidity	Class 3K3 in accordance with IEC/EN 60721-3-3 / no condensation inside the enclosure, max. 95 % relative humidity
Altitude	Up to 1000 m no derating necessary 1000...2000 m derating of 1 % / 100 m (for all types of mains) 2000...3800 m derating of 1 % / 100 m (only TT/TN, IT) 3800...4800 m derating of 1 % / 100 m (only TT/TN)
Allowed pollution	Pollution degree IP23: 2 according to EN 61800-5-1 Pollution degree IP54 (optional): 3 according to EN 61800-5-1 Chemical / mechanical classification: 3C3 and 3S3 according to EN 60721-3-3
Protection class	Class 1 according to EN 61800-5-1

Functional safety	
Functional safety of the drive	The function "Safe Torque Off" (STO) allows a controlled shut-down and switch-off of the power supply to the motor. It also helps to prevent any unintended start of the motor according to ISO 13849-1, performance level PL e, according to IEC/EN 61508 safety integrity level SIL 3 and IEC/EN 61800-5-2.
Response time	≤ 100 ms at STO (Safe Torque Off)
Standards	
Basic standard	The devices are designed, built and tested on the basis of EN 61800-2, EN 61800-3, EN 61800-5-1 and EN 60204-1.
EMC immunity	According to EN 61800-3, second environment (EN 61000-4-2; EN 61000-4-3; EN 61000-4-4; EN 61000-4-5; EN 61000-4-6)
EMC emission	In accordance with product standard EN 61800-3, second environment, category C3
Insulation	Galvanic insulation of the control circuit in accordance with EN 61800-5-1 PELV (Protective Extra Low Voltage)
Standards	CE, EAC, RCM, ATEX, IEEE 519 (THDi < 5%), RFI filter for second "industrial environment" C3 integrated

**Protection Degree**

The standard design of the Altivar Process Drive Systems complies with protection degree IP23. It provides optimal cooling of the built-in frequency inverter modules and all power components as well as maximum compactness at the same time.

Standard enclosure design IP23	
	<p>For optimized cooling of the Altivar Process Drive System, all power part components are arranged in the main cooling air channel.</p> <p>The input of the cooling air takes place by a grid in the lower area of the enclosure door.</p> <p>The internal fan, which is in a separated air channel, provides the cooling of the power part. The air outlet takes place through the top of the enclosure.</p> <p>The heat losses of the control part are exhausted by a fan in the enclosure door.</p> <ol style="list-style-type: none"> <li>1 Air inflow grid (without filter mat) for control part and power part</li> <li>2 Filter components</li> <li>3 Fans for power part</li> <li>4 Active Front End module</li> <li>5 dv/dt filter choke (from 200 kW built-in as standard)</li> <li>6 Air outlet through metal grid with splash water protection</li> <li>7 Air outlet (without filter mat) with fans for control part</li> </ol> <p>Air inflow temperature: -10...+50 °C (below 0 °C with additional enclosure heating, above +40 °C with derating)</p>

**NOTE:** For details about the increased protection degree IP54 see chapter "Increased Protection Degree IP54", page 94.

## Cooling concept

### Control/monitoring of fans

The power part fans as well as the fans in the enclosure door are controlled energy optimized depending on the operation. Switching the fans on and off is derived from the start/stop request.

The fans in the power part are equipped with speed monitoring and the fans in the enclosure doors include a temperature monitoring and that helps to protect the Altivar Process Drive Systems. If one of these monitoring units triggers, a warning message is generated.

Furthermore, the operating hours of all fans can be monitored and a warning message can be triggered when the set limit is exceeded.

### Overtemperature protection

The temperature of the power part is monitored all the time. In case of overtemperature the pulse frequency or the power is automatically reduced.

The temperature of the control part is monitored with a thermostat. When the set temperature is exceeded, a warning message is generated. Only in case of insufficient cooling the drive is necessarily shut down.

## Maximum Ambient Temperature

Depending on the chosen pulse frequency, the maximum ambient temperature and the desired output frequency a derating is necessary. This can be determined by means of the following diagrams.

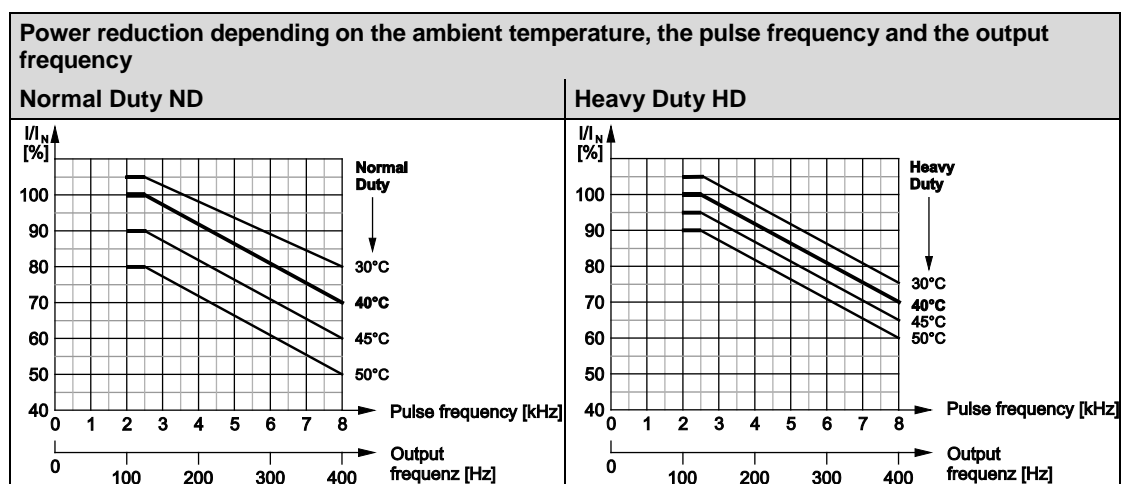

Observe the following guidelines:

- In case of output frequencies higher than 125 Hz the pulse frequency is increased automatically. So the pulse frequency is increased to 4 kHz at 200 Hz output frequency, for example. Consequently, a derating of 8 % at max. 40°C has to be considered.
- Due to the reduction of the output current also the overload capability of the Altivar Process Drive System is reduced.
- At higher pulse frequencies the allowed motor cable length is reduced (see page 70).
- For full shaft power the motor size should not be more than one power rating bigger than the drive.

**NOTE:** If the ambient temperature is too high, the pulse frequency is automatically reduced which helps to prevent an overload of the inverter (except in case of operation with sinus-motor-filter).

## Specification

### Technical Data ATV680C11●4X1

Type		ATV680C11●4X1	
Nominal data		Normal Duty ND	Heavy Duty HD <sup>(1)</sup>
Typical motor rating $P_n$	$U_n = 400\text{ V}$	110 kW	90 kW
	$U_n = 440\text{ V}$	110 kW	90 kW
	$U_n = 480\text{ V}$	132 kW	110 kW
Rated output current $I_n$		211 A	173 A
Maximum current $I_{MAX}$ for 60 s per 10 minutes		232 A	260 A
<b>Input</b>			
Rated input current $I_{in}$ (at $I_{SC} = 22\text{ kA}$ )	$U_n = 400\text{ V}$	175 A	144 A
	$U_n = 440\text{ V}$	159 A	132 A
	$U_n = 480\text{ V}$	175 A	147 A
Rated apparent power $S_n$	$U_n = 400\text{ V}$	121 kVA	100 kVA
	$U_n = 440\text{ V}$	121 kVA	100 kVA
	$U_n = 480\text{ V}$	145 kVA	123 kVA
Current harmonic THDi <sup>(2)</sup>		< 5 %	
<b>Protection for upstream cables</b>			
Pre-fuse	$U_n = 400, 440, 480\text{ V}$	250 A gG	250 A gG
Circuit breaker $I_{therm} / I_{magn}$		230 A / 2 kA	200 A / 2 kA
<b>Internal short-circuit protection</b>			
Fuse	$U_n = 400, 440, 480\text{ V}$	250 A aR	
<b>Characteristics</b>			
Efficiency at $I_n$		0.965	
Heat losses at $I_n$	Total losses	4220 W	3480 W
	Control part only	560 W	470 W
Weight	Net	400 kg	
	Gross	445 kg	
<b>Ambient conditions</b>			
Air flow	Power part	1160 m <sup>3</sup> /h	
	Control part	140 m <sup>3</sup> /h	
Sound pressure level		70 dB(A)	
Rated short-circuit current $I_{SC}$	Minimum <sup>(3)</sup>	3 kA	
	Maximum <sup>(4)</sup>	50 kA (100 ms)	
<b>Mains and motor connection <sup>(5)</sup></b>			
Typical cable		1x (3x 120 mm <sup>2</sup> ) or 2x (3x 50 mm <sup>2</sup> )	1x (3x 95 mm <sup>2</sup> )
Max. Cable cross section <sup>(6)</sup>	Cable	2x (3x 240 mm <sup>2</sup> ) or 3x (3x 120 mm <sup>2</sup> ) or 4x (3x 95 mm <sup>2</sup> )	
	Cable entry <sup>(7)</sup>	max. 360 mm	
Terminals per phase		4x M12	
<p><b>(1)</b> For Heavy Duty HD operation parameter [Dual Rating] <i>drL</i> has to be set to [High rating] <i>HiGH</i> (see programming manual <i>EAV64318</i>).</p> <p><b>(2)</b> For details see table under chapter "Mains Current Harmonics / Mains Voltage Distortion", page 67.</p> <p><b>(3)</b> Minimum mains short-circuit current</p> <p><b>(4)</b> Permitted short-circuit current when the specified pre-fuse or circuit breaker is installed</p> <p><b>(5)</b> You will find further information at chapter "Mains Connection", page 65 and at chapter "Motor Connection", page 68.</p> <p><b>(6)</b> Greater connection cross sections are possible with the separate connection enclosure.</p> <p><b>(7)</b> Maximum possible width of cables connected next to each other in the enclosure</p>			

Dimensions IP23 for Size 1a

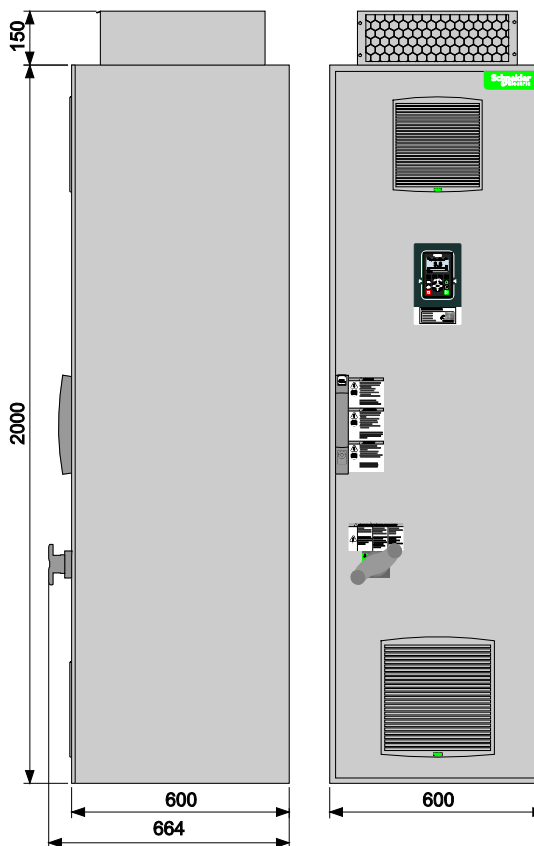

Interior View IP23 for Size 1a

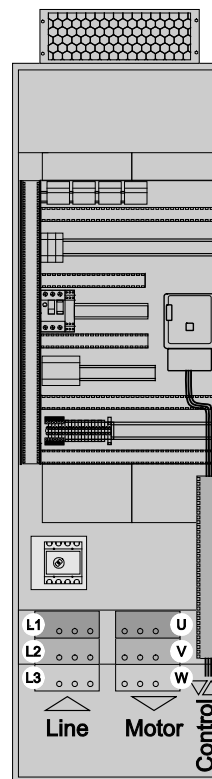

**NOTE:** Following customizations affect the total dimensions:

- Increased protection degree IP54
- Enclosure plinth for basic device
- Connection enclosure cable from top/bottom

## Technical Data ATV680C13●4X1

Type		ATV680C13●4X1	
Nominal data		Normal Duty ND	Heavy Duty HD <sup>(1)</sup>
Typical motor rating $P_n$	$U_n = 400\text{ V}$	132 kW	110 kW
	$U_n = 440\text{ V}$	132 kW	110 kW
	$U_n = 480\text{ V}$	160 kW	132 kW
Rated output current $I_n$		250 A	211 A
Maximum current $I_{MAX}$ for 60 s per 10 minutes		275 A	317 A
<b>Input</b>			
Rated input current $I_{in}$ (at $I_{SC} = 35\text{ kA}$ )	$U_n = 400\text{ V}$	208 A	174 A
	$U_n = 440\text{ V}$	190 A	159 A
	$U_n = 480\text{ V}$	211 A	175 A
Rated apparent power $S_n$	$U_n = 400\text{ V}$	144 kVA	121 kVA
	$U_n = 440\text{ V}$	145 kVA	121 kVA
	$U_n = 480\text{ V}$	175 kVA	145 kVA
Current harmonic THDi <sup>(2)</sup>		< 5 %	
<b>Protection for upstream cables</b>			
Pre-fuse $U_n = 400, 440, 480\text{ V}$		300 A gG	300 A gG
Circuit breaker $I_{therm} / I_{mag}$		280 A / 3 kA	240 A / 3 kA
<b>Internal short-circuit protection</b>			
Fuse $U_n = 400, 440, 480\text{ V}$		315 A aR	
<b>Characteristics</b>			
Efficiency at $I_n$		0.965	
Heat losses at $I_n$	Total losses	5110 W	4200 W
	Control part only	660 W	540 W
Weight	Net	400 kg	
	Gross	445 kg	
<b>Ambient conditions</b>			
Air flow	Power part	1160 m <sup>3</sup> /h	
	Control part	140 m <sup>3</sup> /h	
Sound pressure level		70 dB(A)	
Rated short-circuit current $I_{SC}$	Minimum <sup>(3)</sup>	3.5 kA	
	Maximum <sup>(4)</sup>	50 kA (100 ms)	
<b>Mains and motor connection <sup>(5)</sup></b>			
Typical cable		1x (3x 150 mm <sup>2</sup> ) or 2x (3x 70 mm <sup>2</sup> )	1x (3x 120 mm <sup>2</sup> ) or 2x (3x 50 mm <sup>2</sup> )
Max. Cable cross section <sup>(6)</sup>	Cable	2x (3x 240 mm <sup>2</sup> ) or 3x (3x 120 mm <sup>2</sup> ) or 4x (3x 95 mm <sup>2</sup> )	
	Cable entry <sup>(7)</sup>	max. 360 mm	
Terminals per phase		4x M12	
<p><b>(1)</b> For Heavy Duty HD operation parameter [Dual Rating] <i>drL</i> has to be set to [High rating] <i>HiGH</i> (see programming manual <i>EAV64318</i>).</p> <p><b>(2)</b> For details see table under chapter "Mains Current Harmonics / Mains Voltage Distortion", page 67.</p> <p><b>(3)</b> Minimum mains short-circuit current</p> <p><b>(4)</b> Permitted short-circuit current when the specified pre-fuse or circuit breaker is installed</p> <p><b>(5)</b> You will find further information at chapter "Mains Connection", page 65 and at chapter "Motor Connection", page 68.</p> <p><b>(6)</b> Greater connection cross sections are possible with the separate connection enclosure.</p> <p><b>(7)</b> Maximum possible width of cables connected next to each other in the enclosure</p>			

Dimensions IP23 for Size 1a

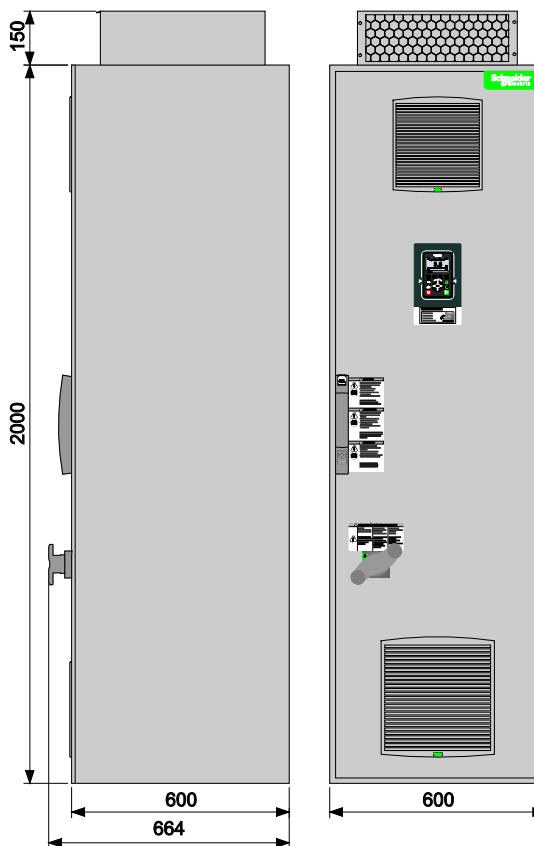

Interior View IP23 for Size 1a

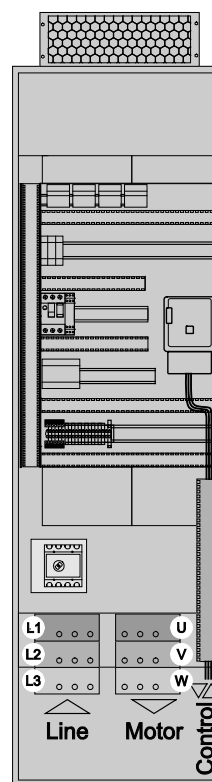

**NOTE:** Following customizations affect the total dimensions:

- Increased protection degree IP54
- Enclosure plinth for basic device
- Connection enclosure cable from top/bottom

## Technical Data ATV680C16●4X1

Type		ATV680C16●4X1	
Nominal data		Normal Duty ND	Heavy Duty HD <sup>(1)</sup>
Typical motor rating $P_n$	$U_n = 400\text{ V}$	160 kW	132 kW
	$U_n = 440\text{ V}$	160 kW	132 kW
	$U_n = 480\text{ V}$	180 kW	160 kW
Rated output current $I_n$		302 A	250 A
Maximum current $I_{MAX}$ for 60 s per 10 minutes		332 A	375 A
<b>Input</b>			
Rated input current $I_{in}$ (at $I_{SC} = 35\text{ kA}$ )	$U_n = 400\text{ V}$	252 A	208 A
	$U_n = 440\text{ V}$	229 A	190 A
	$U_n = 480\text{ V}$	236 A	211 A
Rated apparent power $S_n$	$U_n = 400\text{ V}$	174 kVA	144 kVA
	$U_n = 440\text{ V}$	174 kVA	145 kVA
	$U_n = 480\text{ V}$	196 kVA	175 kVA
Current harmonic THDi <sup>(2)</sup>		< 5 %	
<b>Protection for upstream cables</b>			
Pre-fuse $U_n = 400, 440, 480\text{ V}$		315 A gG	300 A gG
Circuit breaker $I_{therm} / I_{mag}$		315 A / 3 kA	280 A / 3 kA
<b>Internal short-circuit protection</b>			
Fuse $U_n = 400, 440, 480\text{ V}$		400 A aR	
<b>Characteristics</b>			
Efficiency at $I_n$		0.965	
Heat losses at $I_n$	Total losses	6400 W	5100 W
	Control part only	820 W	650 W
Weight	Net	400 kg	
	Gross	445 kg	
<b>Ambient conditions</b>			
Air flow	Power part	1160 m <sup>3</sup> /h	
	Control part	140 m <sup>3</sup> /h	
Sound pressure level		70 dB(A)	
Rated short-circuit current $I_{SC}$	Minimum <sup>(3)</sup>	4 kA	
	Maximum <sup>(4)</sup>	50 kA (100 ms)	
<b>Mains and motor connection <sup>(5)</sup></b>			
Typical cable		1x (3x 185 mm <sup>2</sup> ) or 2x (3x 95 mm <sup>2</sup> )	1x (3x 150 mm <sup>2</sup> ) or 2x (3x 70 mm <sup>2</sup> )
Max. Cable cross section <sup>(6)</sup>	Cable	2x (3x 240 mm <sup>2</sup> ) or 3x (3x 120 mm <sup>2</sup> ) or 4x (3x 95 mm <sup>2</sup> )	
	Cable entry <sup>(7)</sup>	max. 360 mm	
Terminals per phase		4x M12	
<p><b>(1)</b> For Heavy Duty HD operation parameter [Dual Rating] <i>drL</i> has to be set to [High rating] <i>HiGH</i> (see programming manual <i>EAV64318</i>).</p> <p><b>(2)</b> For details see table under chapter "Mains Current Harmonics / Mains Voltage Distortion", page 67.</p> <p><b>(3)</b> Minimum mains short-circuit current</p> <p><b>(4)</b> Permitted short-circuit current when the specified pre-fuse or circuit breaker is installed</p> <p><b>(5)</b> You will find further information at chapter "Mains Connection", page 65 and at chapter "Motor Connection", page 68.</p> <p><b>(6)</b> Greater connection cross sections are possible with the separate connection enclosure.</p> <p><b>(7)</b> Maximum possible width of cables connected next to each other in the enclosure</p>			



Dimensions IP23 for Size 1a

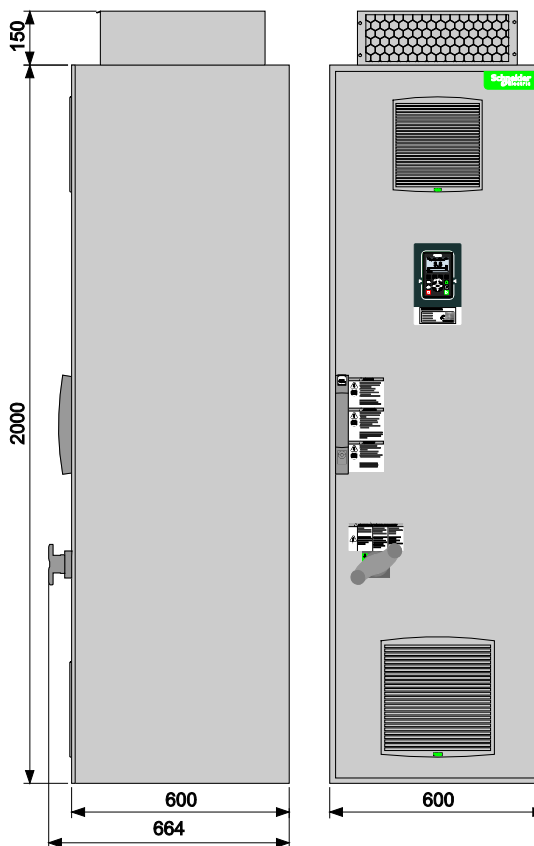

Interior View IP23 for Size 1a

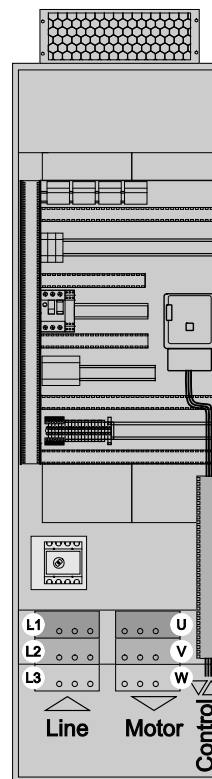

**NOTE:** Following customizations affect the total dimensions:

- Increased protection degree IP54
- Enclosure plinth for basic device
- Connection enclosure cable from top/bottom

## Technical Data ATV680C20●4X1

Type		ATV680C20●4X1	
Nominal data		Normal Duty ND	Heavy Duty HD <sup>(1)</sup>
Typical motor rating $P_n$	$U_n = 400\text{ V}$	200 kW	160 kW
	$U_n = 440\text{ V}$	200 kW	160 kW
	$U_n = 480\text{ V}$	220 kW	180 kW
Rated output current $I_n$		370 A	302 A
Maximum current $I_{MAX}$ for 60 s per 10 minutes		407 A	453 A
<b>Input</b>			
Rated input current $I_{in}$ (at $I_{SC} = 35\text{ kA}$ )	$U_n = 400\text{ V}$	313 A	252 A
	$U_n = 440\text{ V}$	285 A	229 A
	$U_n = 480\text{ V}$	287 A	236 A
Rated apparent power $S_n$	$U_n = 400\text{ V}$	217 kVA	174 kVA
	$U_n = 440\text{ V}$	217 kVA	174 kVA
	$U_n = 480\text{ V}$	239 kVA	196 kVA
Current harmonic THDi <sup>(2)</sup>		< 5 %	
<b>Protection for upstream cables</b>			
Pre-fuse $U_n = 400, 440, 480\text{ V}$		400 A gG	355 A gG
Circuit breaker $I_{therm} / I_{magn}$		400 A / 4 kA	330 A / 4 kA
<b>Internal short-circuit protection</b>			
Fuse $U_n = 400, 440, 480\text{ V}$		2x 250 A aR	
<b>Characteristics</b>			
Efficiency at $I_n$		0.965	
Heat losses at $I_n$	Total losses	7890 W	6450 W
	Control part only	940 W	770 W
Weight	Net	700 kg	
	Gross	755 kg	
<b>Ambient conditions</b>			
Air flow	Power part	2320 m <sup>3</sup> /h	
	Control part	280 m <sup>3</sup> /h	
Sound pressure level		73 dB(A)	
Rated short-circuit current $I_{SC}$	Minimum <sup>(3)</sup>	5.5 kA	
	Maximum <sup>(4)</sup>	50 kA (100 ms)	
<b>Mains and motor connection <sup>(5)</sup></b>			
Typical cable		2x (3x 120 mm <sup>2</sup> ) or 3x (3x 70 mm <sup>2</sup> )	1x (3x 185 mm <sup>2</sup> ) or 2x (3x 95 mm <sup>2</sup> )
Max. Cable cross section <sup>(6)</sup>	Cable	2x (3x 240 mm <sup>2</sup> ) or 4x (3x 185 mm <sup>2</sup> )	
	Cable entry <sup>(7)</sup>	max. 760 mm	
Terminals per phase		4x M12	
<p><b>(1)</b> For Heavy Duty HD operation parameter [Dual Rating] <math>drL</math> has to be set to [High rating] <math>HiGH</math> (see programming manual <i>EAV64318</i>).</p> <p><b>(2)</b> For details see table under chapter "Mains Current Harmonics / Mains Voltage Distortion", page 67.</p> <p><b>(3)</b> Minimum mains short-circuit current</p> <p><b>(4)</b> Permitted short-circuit current when the specified pre-fuse or circuit breaker is installed</p> <p><b>(5)</b> You will find further information at chapter "Mains Connection ", page 65 and at chapter "Motor Connection", page 68.</p> <p><b>(6)</b> Greater connection cross sections are possible with the separate connection enclosure.</p> <p><b>(7)</b> Maximum possible width of cables connected next to each other in the enclosure</p>			

Dimensions IP23 for Size 2a

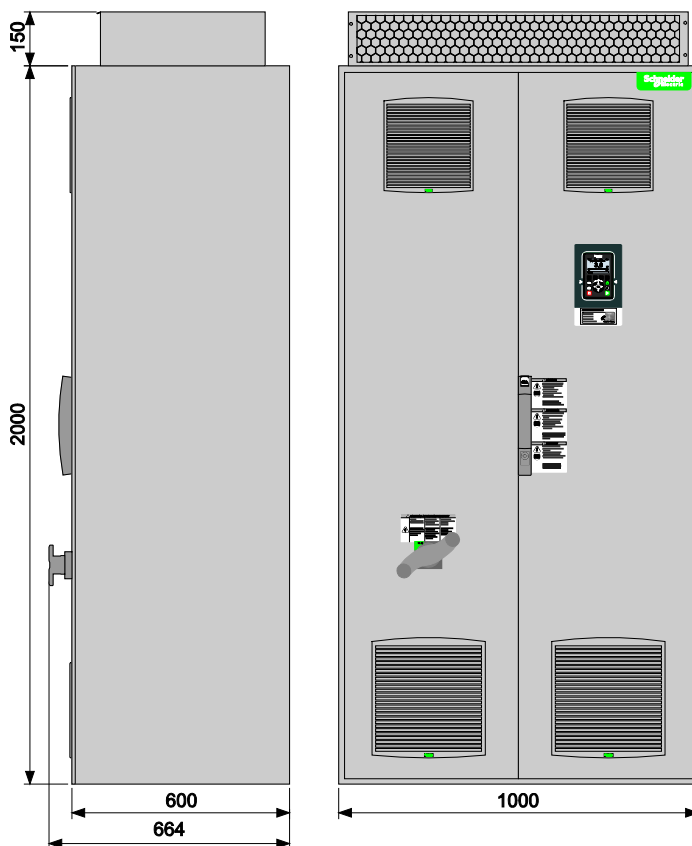

Interior View IP23 for Size 2a

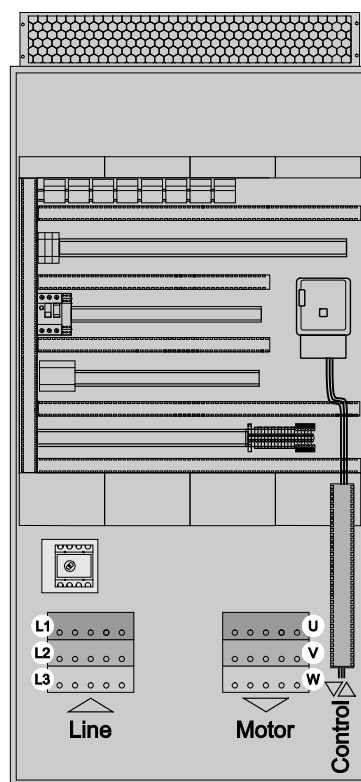

**NOTE:** Following customizations affect the total dimensions:

- Increased protection degree IP54
- Enclosure plinth for basic device
- Connection enclosure cable from top/bottom

## Technical Data ATV680C25●4X1

Type		ATV680C25●4X1	
Nominal data		Normal Duty ND	Heavy Duty HD <sup>(1)</sup>
Typical motor rating P <sub>n</sub>	U <sub>n</sub> = 400 V	250 kW	200 kW
	U <sub>n</sub> = 440 V	250 kW	200 kW
	U <sub>n</sub> = 480 V	280 kW	220 kW
Rated output current I <sub>n</sub>		477 A	370 A
Maximum current I <sub>MAX</sub> for 60 s per 10 minutes		525 A	555 A
<b>Input</b>			
Rated input current I <sub>in</sub> (at I <sub>sc</sub> = 50 kA)	U <sub>n</sub> = 400 V	389 A	313 A
	U <sub>n</sub> = 440 V	354 A	285 A
	U <sub>n</sub> = 480 V	363 A	287 A
Rated apparent power S <sub>n</sub>	U <sub>n</sub> = 400 V	270 kVA	217 kVA
	U <sub>n</sub> = 440 V	270 kVA	217 kVA
	U <sub>n</sub> = 480 V	302 kVA	239 kVA
Current harmonic THDi <sup>(2)</sup>		< 5 %	
<b>Protection for upstream cables</b>			
Pre-fuse	U <sub>n</sub> = 400, 440, 480 V	500 A gG	400 A gG
Circuit breaker I <sub>therm</sub> / I <sub>mag</sub>		500 A / 5 kA	400 A / 5 kA
<b>Internal short-circuit protection</b>			
Fuse	U <sub>n</sub> = 400, 440, 480 V	2x 315 A aR	
<b>Characteristics</b>			
Efficiency at I <sub>n</sub>		0.965	
Heat losses at I <sub>n</sub>	Total losses	9910 W	7870 W
	Control part only	1160 W	920 W
Weight	Net	700 kg	
	Gross	755 kg	
<b>Ambient conditions</b>			
Air flow	Power part	2320 m <sup>3</sup> /h	
	Control part	280 m <sup>3</sup> /h	
Sound pressure level		73 dB(A)	
Rated short-circuit current I <sub>sc</sub>	Minimum <sup>(3)</sup>	7 kA	
	Maximum <sup>(4)</sup>	50 kA (100 ms)	
<b>Mains and motor connection <sup>(5)</sup></b>			
Typical cable		2x (3x 150 mm <sup>2</sup> ) or 3x (3x 95 mm <sup>2</sup> )	2x (3x 120 mm <sup>2</sup> ) or 3x (3x 70 mm <sup>2</sup> )
Max. Cable cross section <sup>(6)</sup>	Cable	2x (3x 240 mm <sup>2</sup> ) or 4x (3x 185 mm <sup>2</sup> )	
	Cable entry <sup>(7)</sup>	max. 760 mm	
Terminals per phase		4x M12	
<p><b>(1)</b> For Heavy Duty HD operation parameter [Dual Rating] <i>drL</i> has to be set to [High rating] <i>HiGH</i> (see programming manual <i>EAV64318</i>).</p> <p><b>(2)</b> For details see table under chapter "Mains Current Harmonics / Mains Voltage Distortion", page 67.</p> <p><b>(3)</b> Minimum mains short-circuit current</p> <p><b>(4)</b> Permitted short-circuit current when the specified pre-fuse or circuit breaker is installed</p> <p><b>(5)</b> You will find further information at chapter "Mains Connection ", page 65 and at chapter "Motor Connection", page 68.</p> <p><b>(6)</b> Greater connection cross sections are possible with the separate connection enclosure.</p> <p><b>(7)</b> Maximum possible width of cables connected next to each other in the enclosure</p>			

Dimensions IP23 for Size 2a

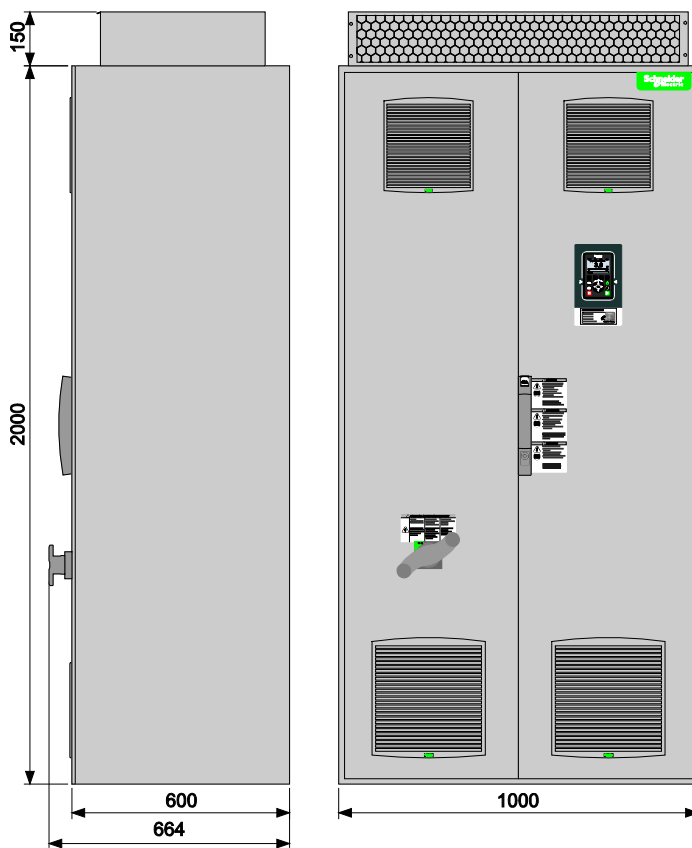

Interior View IP23 for Size 2a

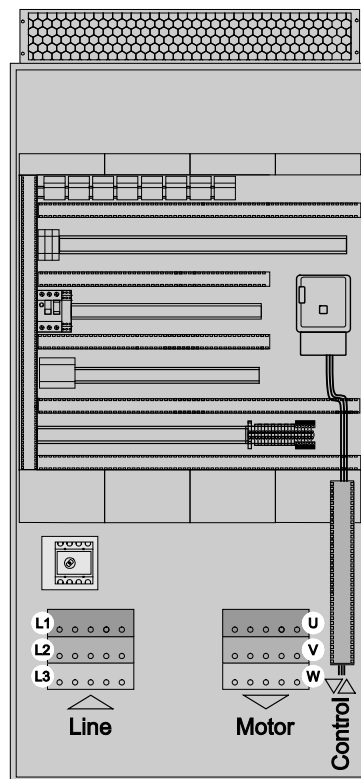

**NOTE:** Following customizations affect the total dimensions:

- Increased protection degree IP54
- Enclosure plinth for basic device
- Connection enclosure cable from top/bottom

## Technical Data ATV680C31●4X1

Type		ATV680C31●4X1	
Nominal data		Normal Duty ND	Heavy Duty HD <sup>(1)</sup>
Typical motor rating $P_n$	$U_n = 400\text{ V}$	315 kW	250 kW
	$U_n = 440\text{ V}$	315 kW	250 kW
	$U_n = 480\text{ V}$	355 kW	280 kW
Rated output current $I_n$		590 A	477 A
Maximum current $I_{MAX}$ for 60 s per 10 minutes		649 A	716 A
<b>Input</b>			
Rated input current $I_{in}$ (at $I_{SC} = 50\text{ kA}$ )	$U_n = 400\text{ V}$	491 A	389 A
	$U_n = 440\text{ V}$	446 A	354 A
	$U_n = 480\text{ V}$	461 A	363 A
Rated apparent power $S_n$	$U_n = 400\text{ V}$	340 kVA	270 kVA
	$U_n = 440\text{ V}$	340 kVA	270 kVA
	$U_n = 480\text{ V}$	383 kVA	302 kVA
Current harmonic THDi <sup>(2)</sup>		< 5 %	
<b>Protection for upstream cables</b>			
Pre-fuse	$U_n = 400, 440, 480\text{ V}$	630 A gG	500 A gG
Circuit breaker $I_{therm} / I_{magn}$		630 A / 6 kA	500 A / 6 kA
<b>Internal short-circuit protection</b>			
Fuse	$U_n = 400, 440, 480\text{ V}$	2x 400 A aR	
<b>Characteristics</b>			
Efficiency at $I_n$		0.965	
Heat losses at $I_n$	Total losses	13060 W	9890 W
	Control part only	1560 W	1140 W
Weight	Net	700 kg	
	Gross	755 kg	
<b>Ambient conditions</b>			
Air flow	Power part	2320 m <sup>3</sup> /h	
	Control part	280 m <sup>3</sup> /h	
Sound pressure level		73 dB(A)	
Rated short-circuit current $I_{SC}$	Minimum <sup>(3)</sup>	8 kA	
	Maximum <sup>(4)</sup>	50 kA (100 ms)	
<b>Mains and motor connection <sup>(5)</sup></b>			
Typical cable		2x (3x 185 mm <sup>2</sup> ) or 3x (3x 120 mm <sup>2</sup> )	2x (3x 150 mm <sup>2</sup> ) or 3x (3x 120 mm <sup>2</sup> )
Max. Cable cross section <sup>(6)</sup>	Cable	2x (3x 240 mm <sup>2</sup> ) or 4x (3x 185 mm <sup>2</sup> )	
	Cable entry <sup>(7)</sup>	max. 760 mm	
Terminals per phase		4x M12	
<p><b>(1)</b> For Heavy Duty HD operation parameter [Dual Rating] <i>drL</i> has to be set to [High rating] <i>HiGH</i> (see programming manual <i>EAV64318</i>).</p> <p><b>(2)</b> For details see table under chapter "Mains Current Harmonics / Mains Voltage Distortion", page 67.</p> <p><b>(3)</b> Minimum mains short-circuit current</p> <p><b>(4)</b> Permitted short-circuit current when the specified pre-fuse or circuit breaker is installed</p> <p><b>(5)</b> You will find further information at chapter "Mains Connection ", page 65 and at chapter "Motor Connection", page 68.</p> <p><b>(6)</b> Greater connection cross sections are possible with the separate connection enclosure.</p> <p><b>(7)</b> Maximum possible width of cables connected next to each other in the enclosure</p>			

Dimensions IP23 for Size 2a

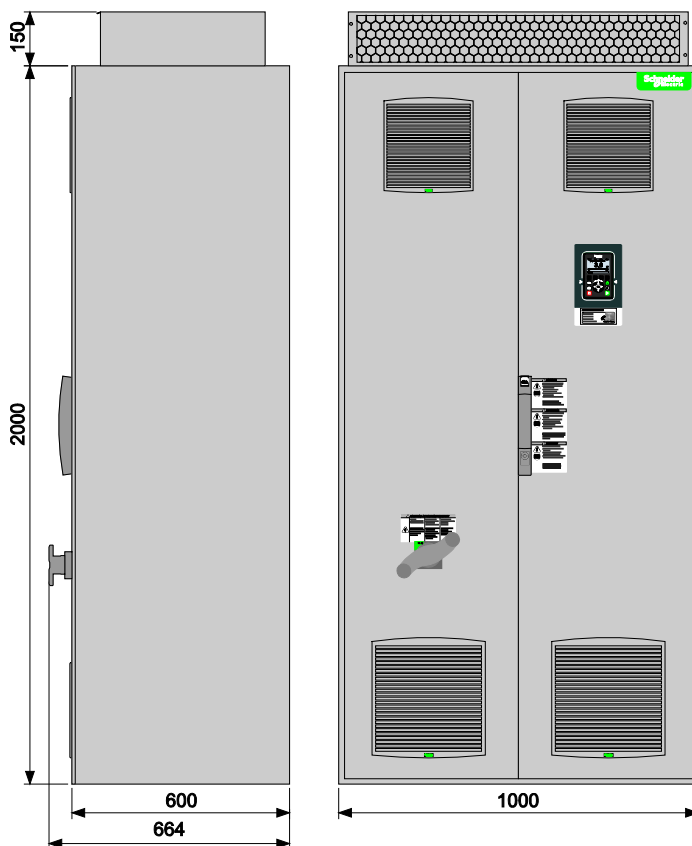

Interior View IP23 for Size 2a

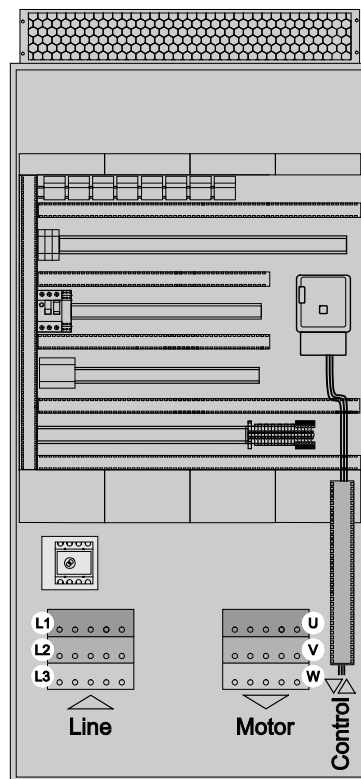

**NOTE:** Following customizations affect the total dimensions:

- Increased protection degree IP54
- Enclosure plinth for basic device
- Connection enclosure cable from top/bottom

## Technical Data ATV680C35●4X1

Type		ATV680C35●4X1	
Nominal data		Normal Duty ND	Heavy Duty HD <sup>(1)</sup>
Typical motor rating P <sub>n</sub>	U <sub>n</sub> = 400 V	355 kW	280 kW
	U <sub>n</sub> = 440 V	355 kW	280 kW
	U <sub>n</sub> = 480 V	400 kW	315 kW
Rated output current I <sub>n</sub>		660 A	520 A
Maximum current I <sub>MAX</sub> for 60 s per 10 minutes		726 A	780 A
<b>Input</b>			
Rated input current I <sub>in</sub> (at I <sub>SCC</sub> = 50 kA)	U <sub>n</sub> = 400 V	553 A	436 A
	U <sub>n</sub> = 440 V	503 A	396 A
	U <sub>n</sub> = 480 V	519 A	409 A
Rated apparent power S <sub>n</sub>	U <sub>n</sub> = 400 V	383 kVA	302 kVA
	U <sub>n</sub> = 440 V	383 kVA	302 kVA
	U <sub>n</sub> = 480 V	432 kVA	340 kVA
Current harmonic THDi <sup>(2)</sup>		< 5 %	
<b>Protection for upstream cables</b>			
Pre-fuse	U <sub>n</sub> = 400, 440, 480 V	800 A gG	630 A gG
Circuit breaker I <sub>therm</sub> / I <sub>magN</sub>		700 A / 7 kA	580 A / 7 kA
<b>Internal short-circuit protection</b>			
Fuse	U <sub>n</sub> = 400, 440, 480 V	3x 315 A aR	
<b>Characteristics</b>			
Efficiency at I <sub>n</sub>		0.965	
Heat losses at I <sub>n</sub>	Total losses	13970 W	10990 W
	Control part only	1570 W	1240 W
Weight	Net	1150 kg	
	Gross	1220 kg	
<b>Ambient conditions</b>			
Air flow	Power part	3480 m <sup>3</sup> /h	
	Control part	420 m <sup>3</sup> /h	
Sound pressure level		75 dB(A)	
Rated short-circuit current I <sub>SCC</sub>	Minimum <sup>(3)</sup>	11 kA	
	Maximum <sup>(4)</sup>	50 kA (100 ms)	
<b>Mains and motor connection <sup>(5)</sup></b>			
Typical cable		3x (3x 150 mm <sup>2</sup> ) or 4x (3x 95 mm <sup>2</sup> )	2x (3x 185 mm <sup>2</sup> ) or 3x (3x 120 mm <sup>2</sup> )
Max. Cable cross section <sup>(6)</sup>	Cable	3x (3x 240 mm <sup>2</sup> ) or 4x (3x 185 mm <sup>2</sup> ) or 6x (3x 120 mm <sup>2</sup> )	
	Cable entry mains <sup>(7)</sup>	max. 360 mm	
	Cable entry motor <sup>(7)</sup>	max. 760 mm	
Terminals per phase		6x M12	
<p><b>(1)</b> For Heavy Duty HD operation parameter [Dual Rating] <i>drL</i> has to be set to [High rating] <i>HiGH</i> (see programming manual <i>EAV64318</i>).</p> <p><b>(2)</b> For details see table under chapter "Mains Current Harmonics / Mains Voltage Distortion", page 67.</p> <p><b>(3)</b> Minimum mains short-circuit current</p> <p><b>(4)</b> Permitted short-circuit current when the specified pre-fuse or circuit breaker is installed</p> <p><b>(5)</b> You will find further information at chapter "Mains Connection", page 65 and at chapter "Motor Connection", page 68.</p> <p><b>(6)</b> Greater connection cross sections are possible with the separate connection enclosure.</p> <p><b>(7)</b> Maximum possible width of cables connected next to each other in the enclosure</p>			



Dimensions IP23 for Size 3a

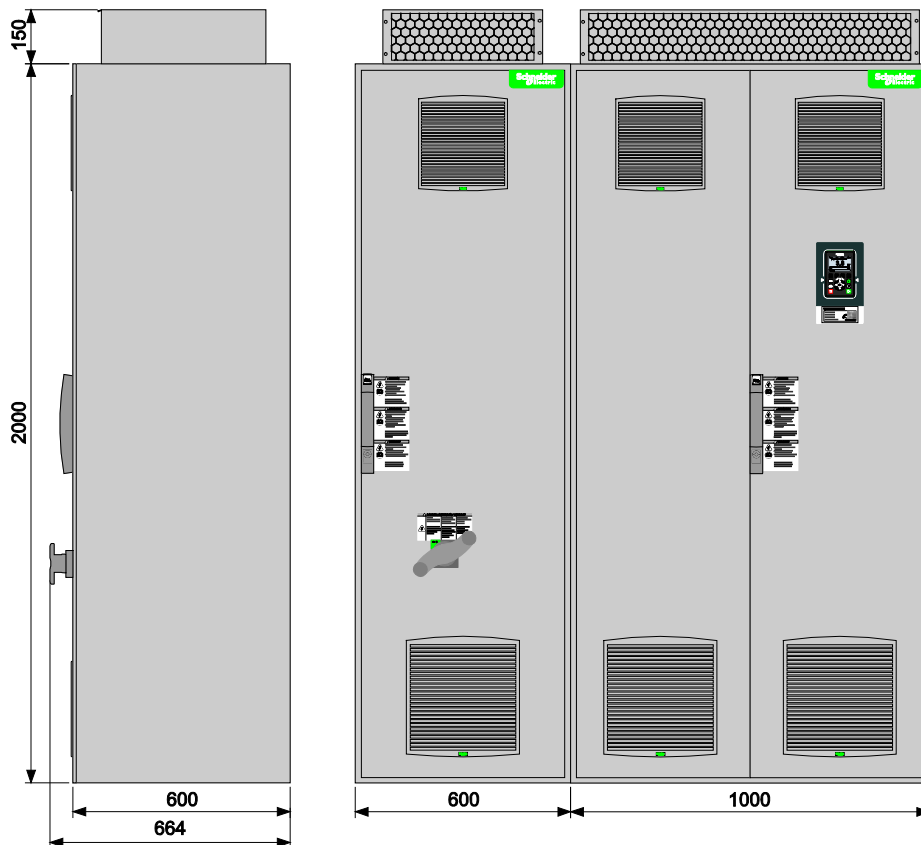

Interior View IP23 for Size 3a

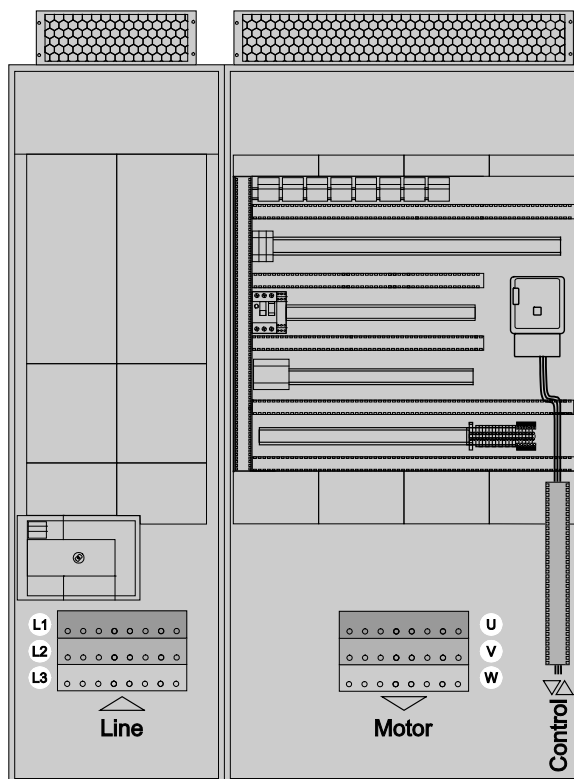

**NOTE:** Following customizations affect the total dimensions:

- Increased protection degree IP54
- Enclosure plinth for basic device
- Connection enclosure cable from top/bottom

## Technical Data ATV680C40●4X1

Type		ATV680C40●4X1	
Nominal data		Normal Duty ND	Heavy Duty HD <sup>(1)</sup>
Typical motor rating P <sub>n</sub>	U <sub>n</sub> = 400 V	400 kW	315 kW
	U <sub>n</sub> = 440 V	400 kW	315 kW
	U <sub>n</sub> = 480 V	450 kW	355 kW
Rated output current I <sub>n</sub>		730 A	590 A
Maximum current I <sub>MAX</sub> for 60 s per 10 minutes		803 A	885 A
<b>Input</b>			
Rated input current I <sub>in</sub> (at I <sub>scc</sub> = 50 kA)	U <sub>n</sub> = 400 V	620 A	491 A
	U <sub>n</sub> = 440 V	563 A	446 A
	U <sub>n</sub> = 480 V	581 A	461 A
Rated apparent power S <sub>n</sub>	U <sub>n</sub> = 400 V	429 kVA	340 kVA
	U <sub>n</sub> = 440 V	429 kVA	340 kVA
	U <sub>n</sub> = 480 V	483 kVA	383 kVA
Current harmonic THDi <sup>(2)</sup>		< 5 %	
<b>Protection for upstream cables</b>			
Pre-fuse	U <sub>n</sub> = 400, 440, 480 V	800 A gG	630 A gG
Circuit breaker I <sub>therm</sub> / I <sub>mag</sub>		780 A / 8 kA	630 A / 8 kA
<b>Internal short-circuit protection</b>			
Fuse	U <sub>n</sub> = 400, 440, 480 V	3x 315 A aR	
<b>Characteristics</b>			
Efficiency at I <sub>n</sub>		0.965	
Heat losses at I <sub>n</sub>	Total losses	15850 W	12300 W
	Control part only	1800 W	1400 W
Weight	Net	1150 kg	
	Gross	1220 kg	
<b>Ambient conditions</b>			
Air flow	Power part	3480 m <sup>3</sup> /h	
	Control part	420 m <sup>3</sup> /h	
Sound pressure level		75 dB(A)	
Rated short-circuit current I <sub>scc</sub>	Minimum <sup>(3)</sup>	11 kA	
	Maximum <sup>(4)</sup>	50 kA (100 ms)	
<b>Mains and motor connection <sup>(5)</sup></b>			
Typical cable		3x (3x 185 mm <sup>2</sup> ) or 4x (3x 120 mm <sup>2</sup> )	3x (3x 120 mm <sup>2</sup> ) or 4x (3x 95 mm <sup>2</sup> )
Max. Cable cross section <sup>(6)</sup>	Cable	3x (3x 240 mm <sup>2</sup> ) or 4x (3x 185 mm <sup>2</sup> ) or 6x (3x 120 mm <sup>2</sup> )	
	Cable entry mains <sup>(7)</sup>	max. 360 mm	
	Cable entry motor <sup>(7)</sup>	max. 760 mm	
Terminals per phase		6x M12	
<p><b>(1)</b> For Heavy Duty HD operation parameter [Dual Rating] <i>drL</i> has to be set to [High rating] <i>HiGH</i> (see programming manual <i>EAV64318</i>).</p> <p><b>(2)</b> For details see table under chapter "Mains Current Harmonics / Mains Voltage Distortion", page 67.</p> <p><b>(3)</b> Minimum mains short-circuit current</p> <p><b>(4)</b> Permitted short-circuit current when the specified pre-fuse or circuit breaker is installed</p> <p><b>(5)</b> You will find further information at chapter "Mains Connection", page 65 and at chapter "Motor Connection", page 68.</p> <p><b>(6)</b> Greater connection cross sections are possible with the separate connection enclosure.</p> <p><b>(7)</b> Maximum possible width of cables connected next to each other in the enclosure</p>			

Dimensions IP23 for Size 3a

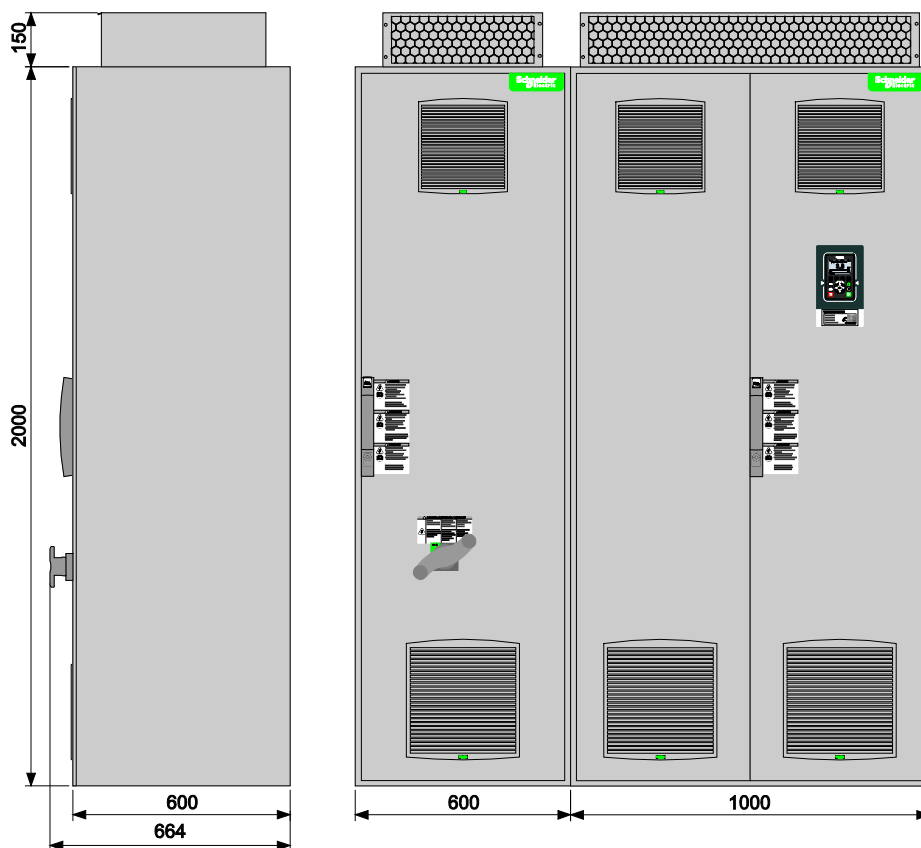

Interior View IP23 for Size 3a

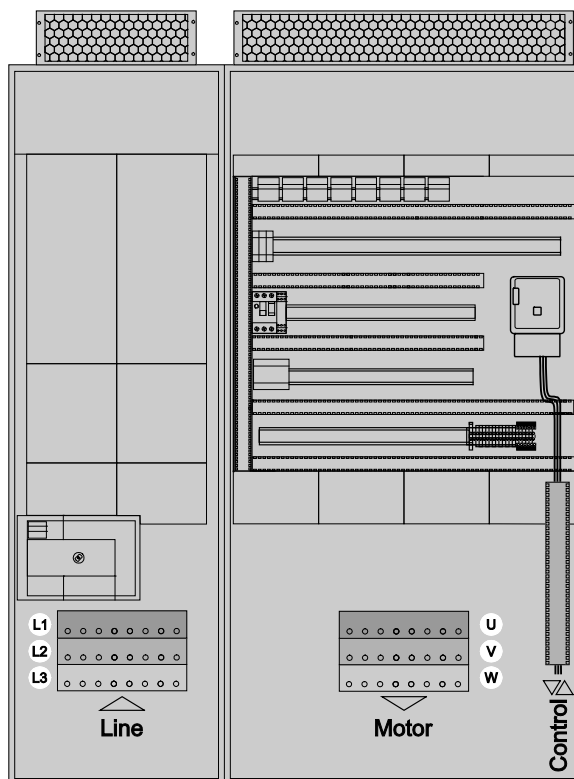

**NOTE:** Following customizations affect the total dimensions:

- Increased protection degree IP54
- Enclosure plinth for basic device
- Connection enclosure cable from top/bottom

## Technical Data ATV680C45●4X1

Type		ATV680C45●4X1	
Nominal data		Normal Duty ND	Heavy Duty HD <sup>(1)</sup>
Typical motor rating P <sub>n</sub>	U <sub>n</sub> = 400 V	450 kW	355 kW
	U <sub>n</sub> = 440 V	450 kW	355 kW
	U <sub>n</sub> = 480 V	500 kW	400 kW
Rated output current I <sub>n</sub>		830 A	660 A
Maximum current I <sub>MAX</sub> for 60 s per 10 minutes		913 A	990 A
<b>Input</b>			
Rated input current I <sub>in</sub> (at I <sub>sc</sub> = 50 kA)	U <sub>n</sub> = 400 V	697 A	553 A
	U <sub>n</sub> = 440 V	634 A	503 A
	U <sub>n</sub> = 480 V	646 A	519 A
Rated apparent power S <sub>n</sub>	U <sub>n</sub> = 400 V	483 kVA	383 kVA
	U <sub>n</sub> = 440 V	483 kVA	383 kVA
	U <sub>n</sub> = 480 V	537 kVA	432 kVA
Current harmonic THDi <sup>(2)</sup>		< 5 %	
<b>Protection for upstream cables</b>			
Pre-fuse	U <sub>n</sub> = 400, 440, 480 V	1000 A gG	800 A gG
Circuit breaker I <sub>therm</sub> / I <sub>mag</sub>		900 A / 9 kA	720 A / 9 kA
<b>Internal short-circuit protection</b>			
Fuse	U <sub>n</sub> = 400, 440, 480 V	3x 400 A aR	
<b>Characteristics</b>			
Efficiency at I <sub>n</sub>		0.965	
Heat losses at I <sub>n</sub>	Total losses	18210 W	13960 W
	Control part only	2060 W	1560 W
Weight	Net	1150 kg	
	Gross	1220 kg	
<b>Ambient conditions</b>			
Air flow	Power part	3480 m <sup>3</sup> /h	
	Control part	420 m <sup>3</sup> /h	
Sound pressure level		75 dB(A)	
Rated short-circuit current I <sub>sc</sub>	Minimum <sup>(3)</sup>	13 kA	
	Maximum <sup>(4)</sup>	50 kA (100 ms)	
<b>Mains and motor connection <sup>(5)</sup></b>			
Typical cable		4x (3x 150 mm <sup>2</sup> ) or 5x (3x 120 mm <sup>2</sup> )	3x (3x 150 mm <sup>2</sup> ) or 4x (3x 95 mm <sup>2</sup> )
Max. Cable cross section <sup>(6)</sup>	Cable	3x (3x 240 mm <sup>2</sup> ) or 4x (3x 185 mm <sup>2</sup> ) or 6x (3x 120 mm <sup>2</sup> )	
	Cable entry mains <sup>(7)</sup>	max. 360 mm	
	Cable entry motor <sup>(7)</sup>	max. 760 mm	
Terminals per phase		6x M12	
<p><b>(1)</b> For Heavy Duty HD operation parameter [Dual Rating] <i>drL</i> has to be set to [High rating] <i>HiGH</i> (see programming manual <i>EAV64318</i>).</p> <p><b>(2)</b> For details see table under chapter "Mains Current Harmonics / Mains Voltage Distortion", page 67.</p> <p><b>(3)</b> Minimum mains short-circuit current</p> <p><b>(4)</b> Permitted short-circuit current when the specified pre-fuse or circuit breaker is installed</p> <p><b>(5)</b> You will find further information at chapter "Mains Connection", page 65 and at chapter "Motor Connection", page 68.</p> <p><b>(6)</b> Greater connection cross sections are possible with the separate connection enclosure.</p> <p><b>(7)</b> Maximum possible width of cables connected next to each other in the enclosure</p>			

Dimensions IP23 for Size 3a

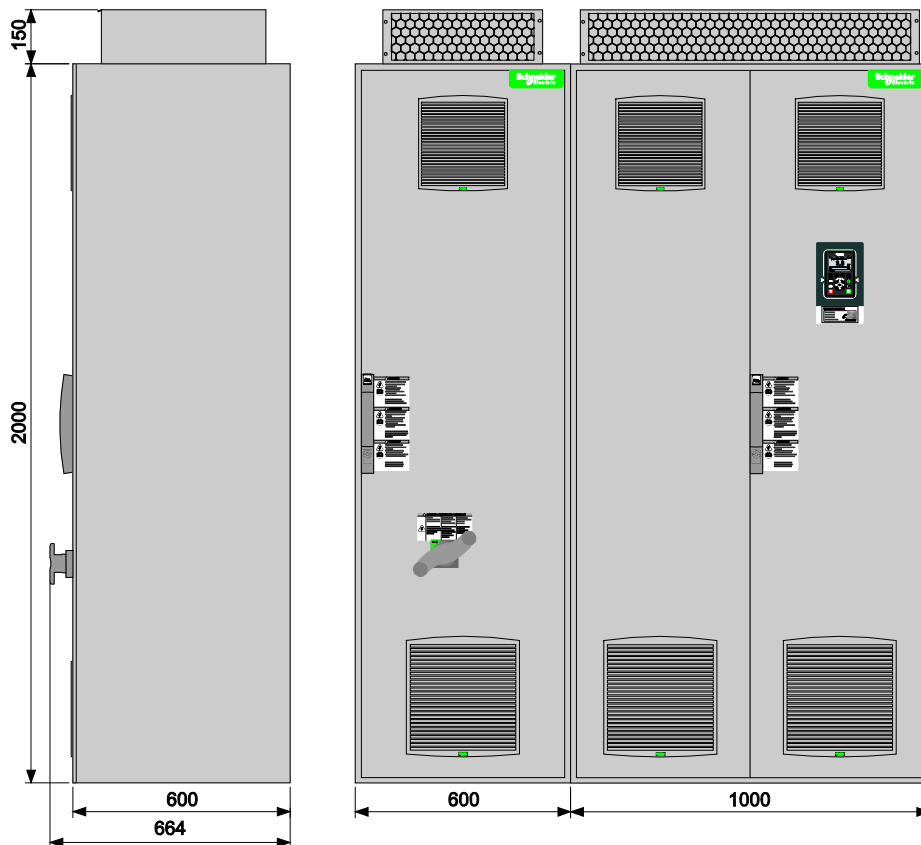

Interior View IP23 for Size 3a

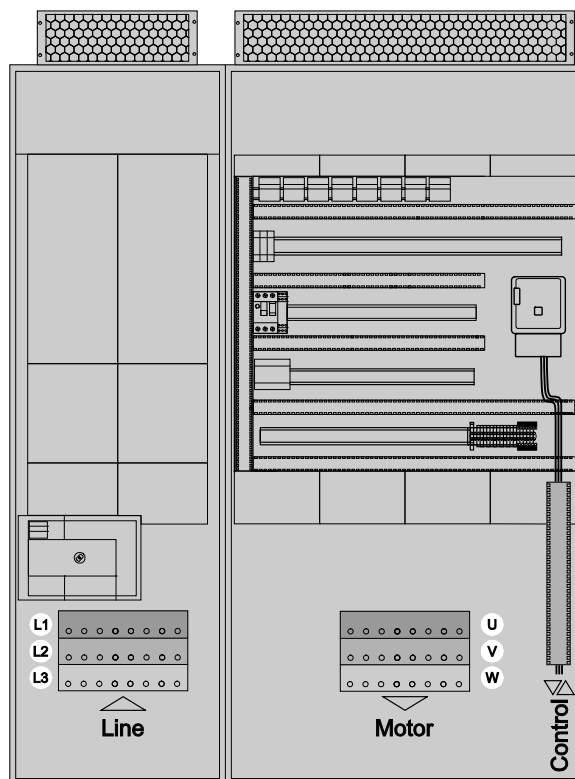

**NOTE:** Following customizations affect the total dimensions:

- Increased protection degree IP54
- Enclosure plinth for basic device
- Connection enclosure cable from top/bottom

## Technical Data ATV680C50●4X1

Type		ATV680C50●4X1	
Nominal data		Normal Duty ND	Heavy Duty HD <sup>(1)</sup>
Typical motor rating P <sub>n</sub>	U <sub>n</sub> = 400 V	500 kW	400 kW
	U <sub>n</sub> = 440 V	500 kW	400 kW
	U <sub>n</sub> = 480 V	560 kW	450 kW
Rated output current I <sub>n</sub>		900 A	730 A
Maximum current I <sub>MAX</sub> for 60 s per 10 minutes		990 A	1095 A
<b>Input</b>			
Rated input current I <sub>in</sub> (at I <sub>sc</sub> = 50 kA)	U <sub>n</sub> = 400 V	775 A	620 A
	U <sub>n</sub> = 440 V	704 A	563 A
	U <sub>n</sub> = 480 V	723 A	581 A
Rated apparent power S <sub>n</sub>	U <sub>n</sub> = 400 V	537 kVA	429 kVA
	U <sub>n</sub> = 440 V	537 kVA	429 kVA
	U <sub>n</sub> = 480 V	601 kVA	483 kVA
Current harmonic THDi <sup>(2)</sup>		< 5 %	
<b>Protection for upstream cables</b>			
Pre-fuse	U <sub>n</sub> = 400, 440, 480 V	1000 A gG	800 A gG
Circuit breaker I <sub>therm</sub> / I <sub>mag</sub>		1000 A / 10 kA	800 A / 10 kA
<b>Internal short-circuit protection</b>			
Fuse	U <sub>n</sub> = 400, 440, 480 V	3x 400 A aR	
<b>Characteristics</b>			
Efficiency at I <sub>n</sub>		0.965	
Heat losses at I <sub>n</sub>	Total losses	20800 W	15830 W
	Control part only	2400 W	1780 W
Weight	Net	1150 kg	
	Gross	1220 kg	
<b>Ambient conditions</b>			
Air flow	Power part	3480 m <sup>3</sup> /h	
	Control part	420 m <sup>3</sup> /h	
Sound pressure level		75 dB(A)	
Rated short-circuit current I <sub>sc</sub>	Minimum <sup>(3)</sup>	13 kA	
	Maximum <sup>(4)</sup>	50 kA (100 ms)	
<b>Mains and motor connection <sup>(5)</sup></b>			
Typical cable		4x (3x 185 mm <sup>2</sup> ) or 5x (3x 120 mm <sup>2</sup> )	3x (3x 185 mm <sup>2</sup> ) or 4x (3x 120 mm <sup>2</sup> )
Max. Cable cross section <sup>(6)</sup>	Cable	3x (3x 240 mm <sup>2</sup> ) or 4x (3x 185 mm <sup>2</sup> ) or 6x (3x 120 mm <sup>2</sup> )	
	Cable entry mains <sup>(7)</sup>	max. 360 mm	
	Cable entry motor <sup>(7)</sup>	max. 760 mm	
Terminals per phase		6x M12	
<p><b>(1)</b> For Heavy Duty HD operation parameter [Dual Rating] <i>drL</i> has to be set to [High rating] <i>HiGH</i> (see programming manual <i>EAV64318</i>).</p> <p><b>(2)</b> For details see table under chapter "Mains Current Harmonics / Mains Voltage Distortion", page 67.</p> <p><b>(3)</b> Minimum mains short-circuit current</p> <p><b>(4)</b> Permitted short-circuit current when the specified pre-fuse or circuit breaker is installed</p> <p><b>(5)</b> You will find further information at chapter "Mains Connection", page 65 and at chapter "Motor Connection", page 68.</p> <p><b>(6)</b> Greater connection cross sections are possible with the separate connection enclosure.</p> <p><b>(7)</b> Maximum possible width of cables connected next to each other in the enclosure</p>			

Dimensions IP23 for Size 3a

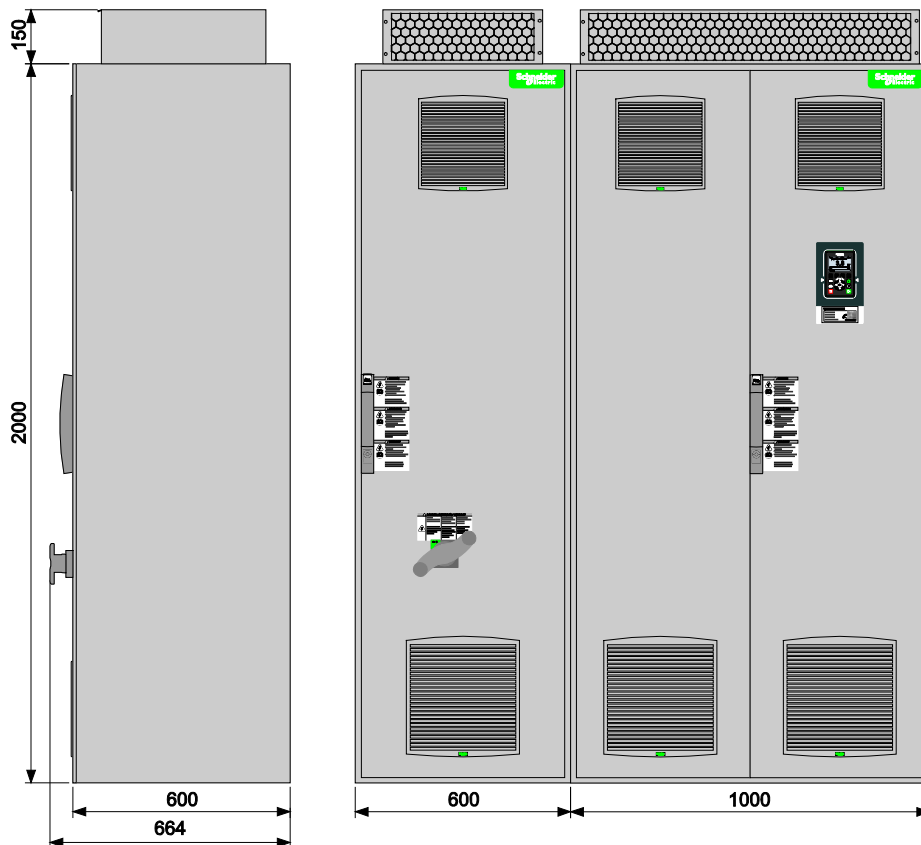

Interior View IP23 for Size 3a

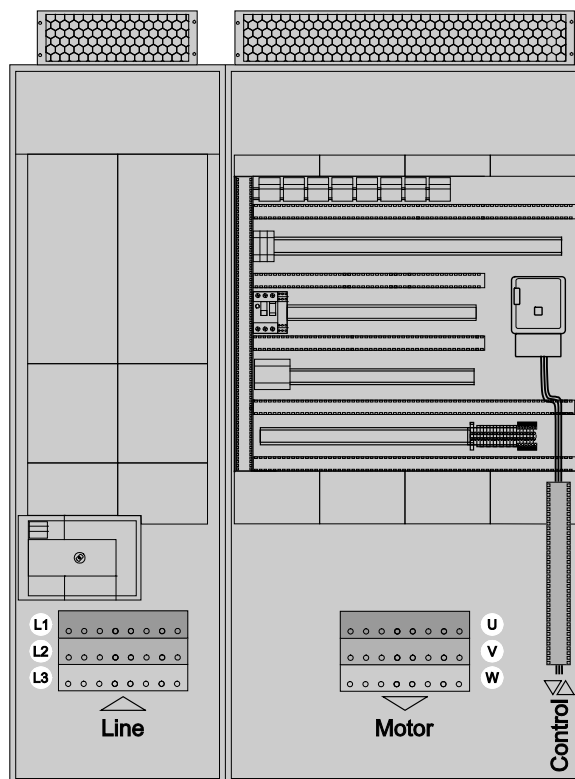

**NOTE:** Following customizations affect the total dimensions:

- Increased protection degree IP54
- Enclosure plinth for basic device
- Connection enclosure cable from top/bottom

## Technical Data ATV680C56●4X1

Type		ATV680C56●4X1	
Nominal data		Normal Duty ND	Heavy Duty HD <sup>(1)</sup>
Typical motor rating $P_n$	$U_n = 400\text{ V}$	560 kW	450 kW
	$U_n = 440\text{ V}$	560 kW	450 kW
	$U_n = 480\text{ V}$	630 kW	500 kW
Rated output current $I_n$		1020 A	830 A
Maximum current $I_{MAX}$ for 60 s per 10 minutes		1122 A	1245 A
<b>Input</b>			
Rated input current $I_{in}$ (at $I_{SC} = 50\text{ kA}$ )	$U_n = 400\text{ V}$	868 A	697 A
	$U_n = 440\text{ V}$	789 A	634 A
	$U_n = 480\text{ V}$	813 A	646 A
Rated apparent power $S_n$	$U_n = 400\text{ V}$	601 kVA	483 kVA
	$U_n = 440\text{ V}$	601 kVA	483 kVA
	$U_n = 480\text{ V}$	676 kVA	537 kVA
Current harmonic THDi <sup>(2)</sup>		< 5 %	
<b>Protection for upstream cables</b>			
Pre-fuse	$U_n = 400, 440, 480\text{ V}$	1250 A gG	1000 A gG
Circuit breaker $I_{therm} / I_{magn}$		1100 A / 11 kA	900 A / 11 kA
<b>Internal short-circuit protection</b>			
Fuse	$U_n = 400, 440, 480\text{ V}$	4x 400 A aR	
<b>Characteristics</b>			
Efficiency at $I_n$		0.965	
Heat losses at $I_n$	Total losses	22300 W	17480 W
	Control part only	2500 W	1930 W
Weight	Net	1450 kg	
	Gross	1530 kg	
<b>Ambient conditions</b>			
Air flow	Power part	4640 m <sup>3</sup> /h	
	Control part	560 m <sup>3</sup> /h	
Sound pressure level		77 dB(A)	
Rated short-circuit current $I_{SC}$	Minimum <sup>(3)</sup>	15 kA	
	Maximum <sup>(4)</sup>	50 kA (100 ms)	
<b>Mains and motor connection <sup>(5)</sup></b>			
Typical cable		4x (3x 185 mm <sup>2</sup> ) or 5x (3x 150 mm <sup>2</sup> )	4x (3x 150 mm <sup>2</sup> ) or 5x (3x 120 mm <sup>2</sup> )
Max. Cable cross section <sup>(6)</sup>	Cable	5x (3x 240 mm <sup>2</sup> ) or 6x (3x 185 mm <sup>2</sup> )	
	Cable entry mains <sup>(7)</sup>	max. 760 mm	
	Cable entry motor <sup>(7)</sup>	max. 760 mm	
Terminals per phase		8x M12	
<p><b>(1)</b> For Heavy Duty HD operation parameter [Dual Rating] <i>drL</i> has to be set to [High rating] <i>HiGH</i> (see programming manual <i>EAV64318</i>).</p> <p><b>(2)</b> For details see table under chapter "Mains Current Harmonics / Mains Voltage Distortion", page 67.</p> <p><b>(3)</b> Minimum mains short-circuit current</p> <p><b>(4)</b> Permitted short-circuit current when the specified pre-fuse or circuit breaker is installed</p> <p><b>(5)</b> You will find further information at chapter "Mains Connection", page 65 and at chapter "Motor Connection", page 68.</p> <p><b>(6)</b> Greater connection cross sections are possible with the separate connection enclosure.</p> <p><b>(7)</b> Maximum possible width of cables connected next to each other in the enclosure</p>			



Dimensions IP23 for Size 4a

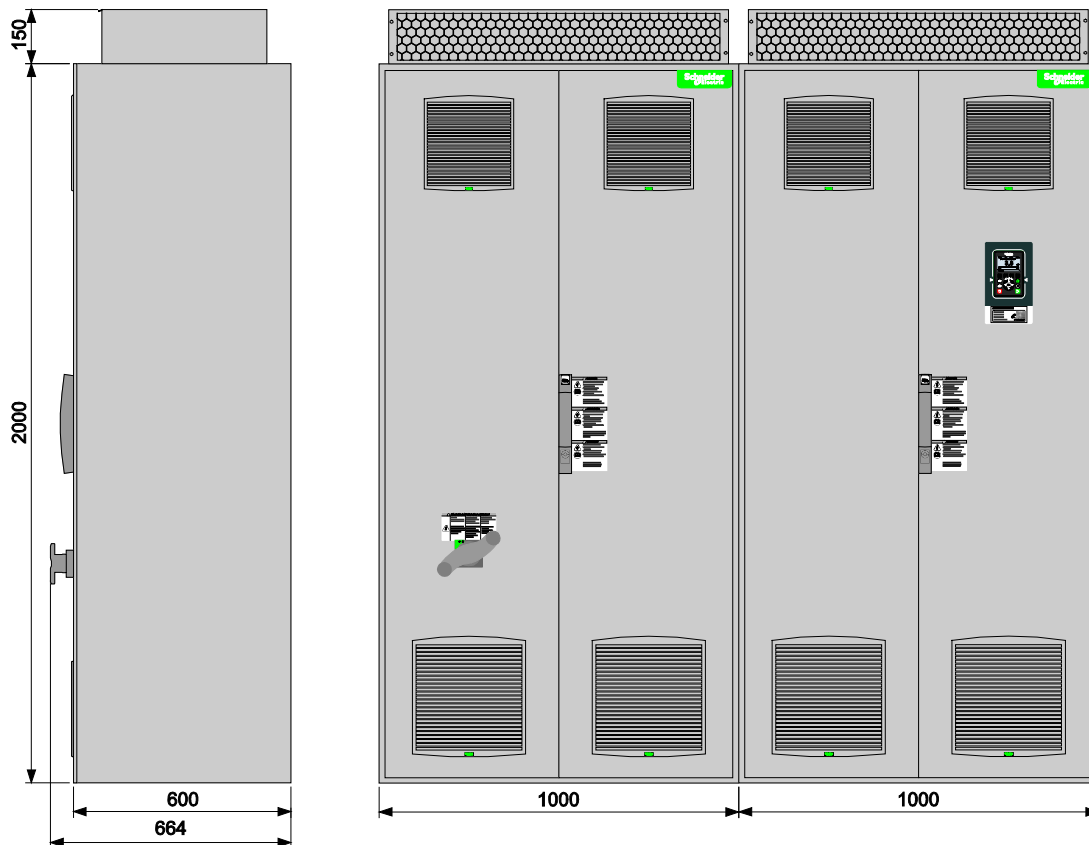

Interior View IP23 for Size 4a

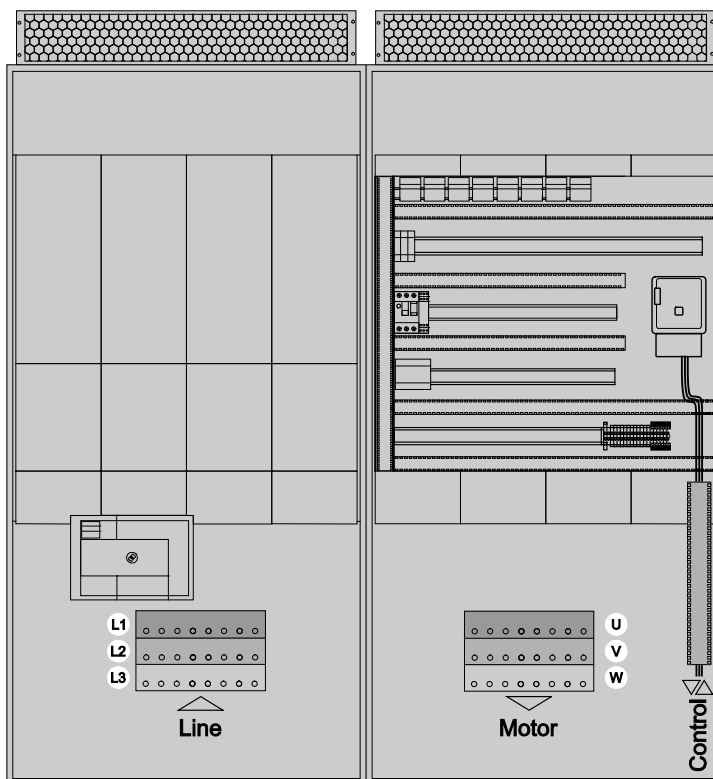

**NOTE:** Following customizations affect the total dimensions:

- Increased protection degree IP54
- Enclosure plinth for basic device
- Connection enclosure cable from top/bottom

## Technical Data ATV680C63●4X1

Type		ATV680C63●4X1	
Nominal data		Normal Duty ND	Heavy Duty HD <sup>(1)</sup>
Typical motor rating P <sub>n</sub>	U <sub>n</sub> = 400 V	630 kW	500 kW
	U <sub>n</sub> = 440 V	630 kW	500 kW
	U <sub>n</sub> = 480 V	710 kW	560 kW
Rated output current I <sub>n</sub>		1140 A	900 A
Maximum current I <sub>MAX</sub> for 60 s per 10 minutes		1254 A	1350 A
<b>Input</b>			
Rated input current I <sub>in</sub> (at I <sub>sc</sub> = 50 kA)	U <sub>n</sub> = 400 V	971 A	775 A
	U <sub>n</sub> = 440 V	883 A	704 A
	U <sub>n</sub> = 480 V	912 A	723 A
Rated apparent power S <sub>n</sub>	U <sub>n</sub> = 400 V	673 kVA	537 kVA
	U <sub>n</sub> = 440 V	673 kVA	537 kVA
	U <sub>n</sub> = 480 V	758 kVA	601 kVA
Current harmonic THDi <sup>(2)</sup>		< 5 %	
<b>Protection for upstream cables</b>			
Pre-fuse	U <sub>n</sub> = 400, 440, 480 V	1250 A gG	1000 A gG
Circuit breaker I <sub>therm</sub> / I <sub>mag</sub>		1250 A / 12 kA	1000 A / 12 kA
<b>Internal short-circuit protection</b>			
Fuse	U <sub>n</sub> = 400, 440, 480 V	4x 400 A aR	
<b>Characteristics</b>			
Efficiency at I <sub>n</sub>		0.965	
Heat losses at I <sub>n</sub>	Total losses	25630 W	19560 W
	Control part only	2930 W	2160 W
Weight	Net	1450 kg	
	Gross	1530 kg	
<b>Ambient conditions</b>			
Air flow	Power part	4640 m <sup>3</sup> /h	
	Control part	560 m <sup>3</sup> /h	
Sound pressure level		77 dB(A)	
Rated short-circuit current I <sub>sc</sub>	Minimum <sup>(3)</sup>	17 kA	
	Maximum <sup>(4)</sup>	50 kA (100 ms)	
<b>Mains and motor connection <sup>(5)</sup></b>			
Typical cable		4x (3x 240 mm <sup>2</sup> ) or 5x (3x 185 mm <sup>2</sup> ) or 6x (3x 120 mm <sup>2</sup> )	4x (3x 185 mm <sup>2</sup> ) or 5x (3x 120 mm <sup>2</sup> )
Max. Cable cross section <sup>(6)</sup>	Cable	5x (3x 240 mm <sup>2</sup> ) or 6x (3x 185 mm <sup>2</sup> )	
	Cable entry mains <sup>(7)</sup>	max. 760 mm	
	Cable entry motor <sup>(7)</sup>	max. 760 mm	
Terminals per phase		8x M12	
<p><b>(1)</b> For Heavy Duty HD operation parameter [Dual Rating] <i>drL</i> has to be set to [High rating] <i>HiGH</i> (see programming manual <i>EAV64318</i>).</p> <p><b>(2)</b> For details see table under chapter "Mains Current Harmonics / Mains Voltage Distortion", page 67.</p> <p><b>(3)</b> Minimum mains short-circuit current</p> <p><b>(4)</b> Permitted short-circuit current when the specified pre-fuse or circuit breaker is installed</p> <p><b>(5)</b> You will find further information at chapter "Mains Connection", page 65 and at chapter "Motor Connection", page 68.</p> <p><b>(6)</b> Greater connection cross sections are possible with the separate connection enclosure.</p> <p><b>(7)</b> Maximum possible width of cables connected next to each other in the enclosure</p>			

Dimensions IP23 for Size 4a

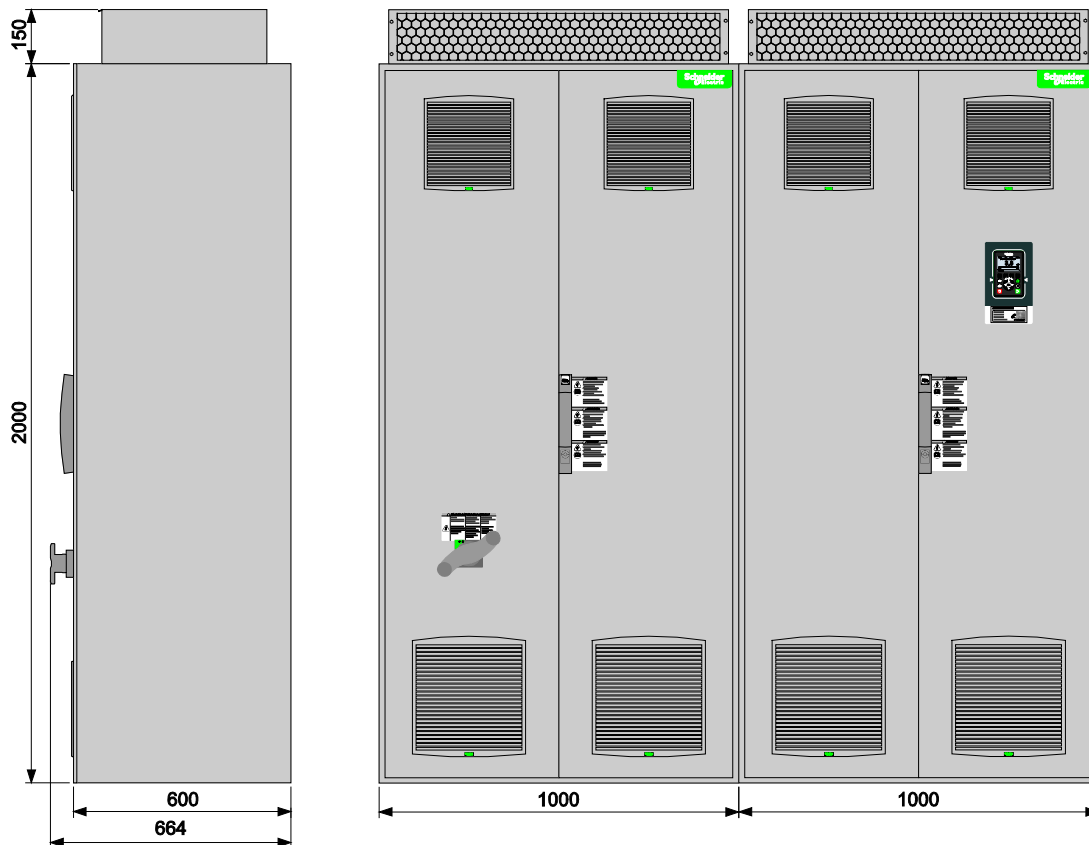

Interior View IP23 for Size 4a

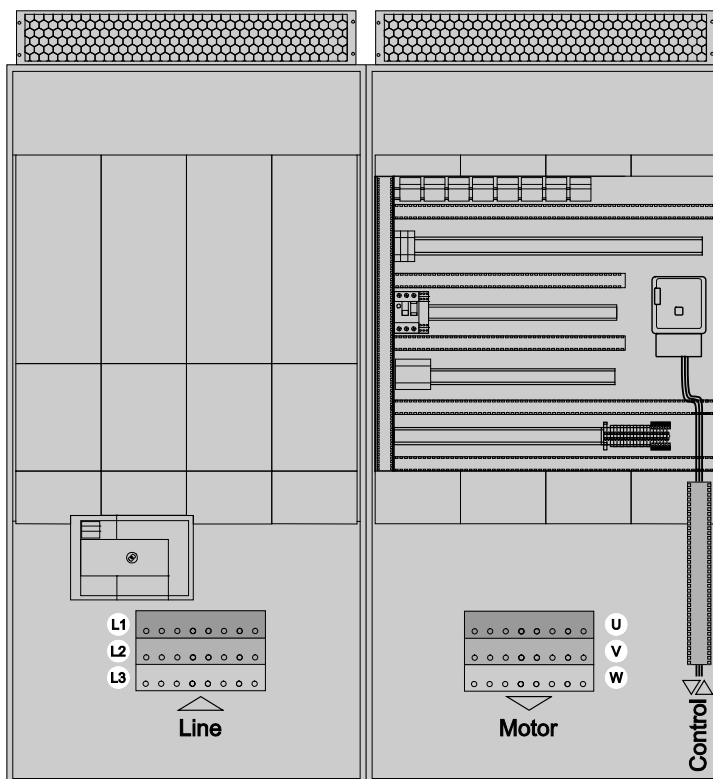

**NOTE:** Following customizations affect the total dimensions:

- Increased protection degree IP54
- Enclosure plinth for basic device
- Connection enclosure cable from top/bottom

## Technical Data ATV680C71●4X1

Type		ATV680C71●4X1	
Nominal data		Normal Duty ND	Heavy Duty HD <sup>(1)</sup>
Typical motor rating $P_n$	$U_n = 400\text{ V}$	710 kW	560 kW
	$U_n = 440\text{ V}$	710 kW	560 kW
	$U_n = 480\text{ V}$	800 kW	630 kW
Rated output current $I_n$		1260 A	1020 A
Maximum current $I_{MAX}$ for 60 s per 10 minutes		1386 A	1530 A
<b>Input</b>			
Rated input current $I_{in}$ (at $I_{SC} = 50\text{ kA}$ )	$U_n = 400\text{ V}$	1094 A	868 A
	$U_n = 440\text{ V}$	995 A	789 A
	$U_n = 480\text{ V}$	1028 A	813 A
Rated apparent power $S_n$	$U_n = 400\text{ V}$	758 kVA	601 kVA
	$U_n = 440\text{ V}$	758 kVA	601 kVA
	$U_n = 480\text{ V}$	854 kVA	676 kVA
Current harmonic THDi <sup>(2)</sup>		< 5 %	
<b>Protection for upstream cables</b>			
Pre-fuse $U_n = 400, 440, 480\text{ V}$		1600 A gG	1250 A gG
Circuit breaker $I_{therm} / I_{magn}$		1400 A / 14 kA	1100 A / 14 kA
<b>Internal short-circuit protection</b>			
Fuse $U_n = 400, 440, 480\text{ V}$		5x 400 A aR	
<b>Characteristics</b>			
Efficiency at $I_n$		0.965	
Heat losses at $I_n$	Total losses	28230 W	21850 W
	Control part only	3230 W	2450 W
Weight	Net	1950 kg	
	Gross	2045 kg	
<b>Ambient conditions</b>			
Air flow	Power part	5800 m <sup>3</sup> /h	
	Control part	700 m <sup>3</sup> /h	
Sound pressure level		78 dB(A)	
Rated short-circuit current $I_{SC}$	Minimum <sup>(3)</sup>	18 kA	
	Maximum <sup>(4)</sup>	50 kA (100 ms)	
<b>Mains and motor connection <sup>(5)</sup></b>			
Typical cable		5x (3x 185 mm <sup>2</sup> ) or 6x (3x 150 mm <sup>2</sup> )	4x (3x 185 mm <sup>2</sup> ) or 5x (3x 150 mm <sup>2</sup> )
Max. Cable cross section <sup>(6)</sup>	Cable	6x (3x 240 mm <sup>2</sup> ) or 8x (3x 150 mm <sup>2</sup> )	
	Cable entry mains <sup>(7)</sup>	max. 760 mm	
	Cable entry motor <sup>(7)</sup>	max. 760 mm	
Terminals per phase		10x M12	
<p><b>(1)</b> For Heavy Duty HD operation parameter [Dual Rating] <i>drL</i> has to be set to [High rating] <i>HiGH</i> (see programming manual <i>EAV64318</i>).</p> <p><b>(2)</b> For details see table under chapter "Mains Current Harmonics / Mains Voltage Distortion", page 67.</p> <p><b>(3)</b> Minimum mains short-circuit current</p> <p><b>(4)</b> Permitted short-circuit current when the specified pre-fuse or circuit breaker is installed</p> <p><b>(5)</b> You will find further information at chapter "Mains Connection", page 65 and at chapter "Motor Connection", page 68.</p> <p><b>(6)</b> Greater connection cross sections are possible with the separate connection enclosure.</p> <p><b>(7)</b> Maximum possible width of cables connected next to each other in the enclosure</p>			

Dimensions IP23 for Size 5a

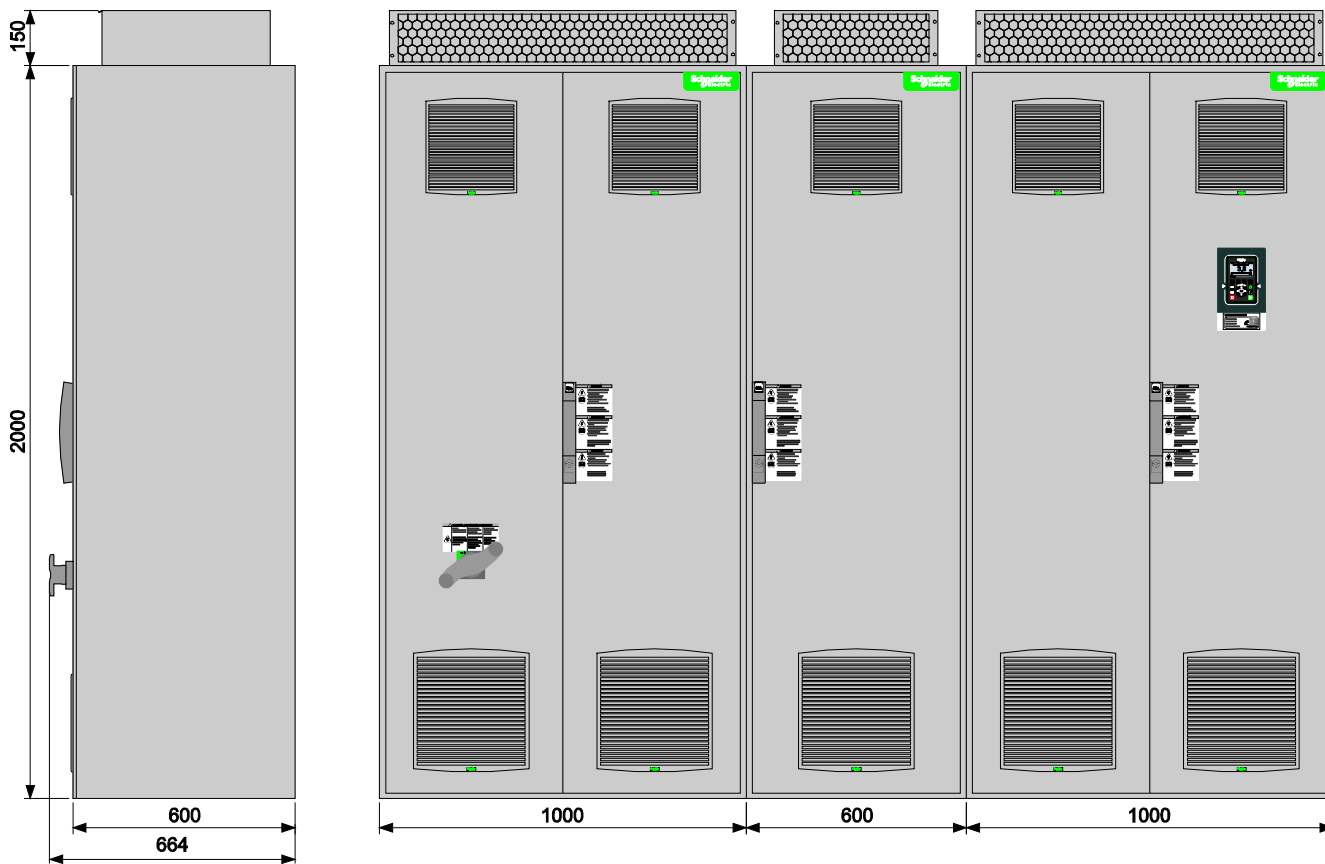

Interior View IP23 for Size 5a

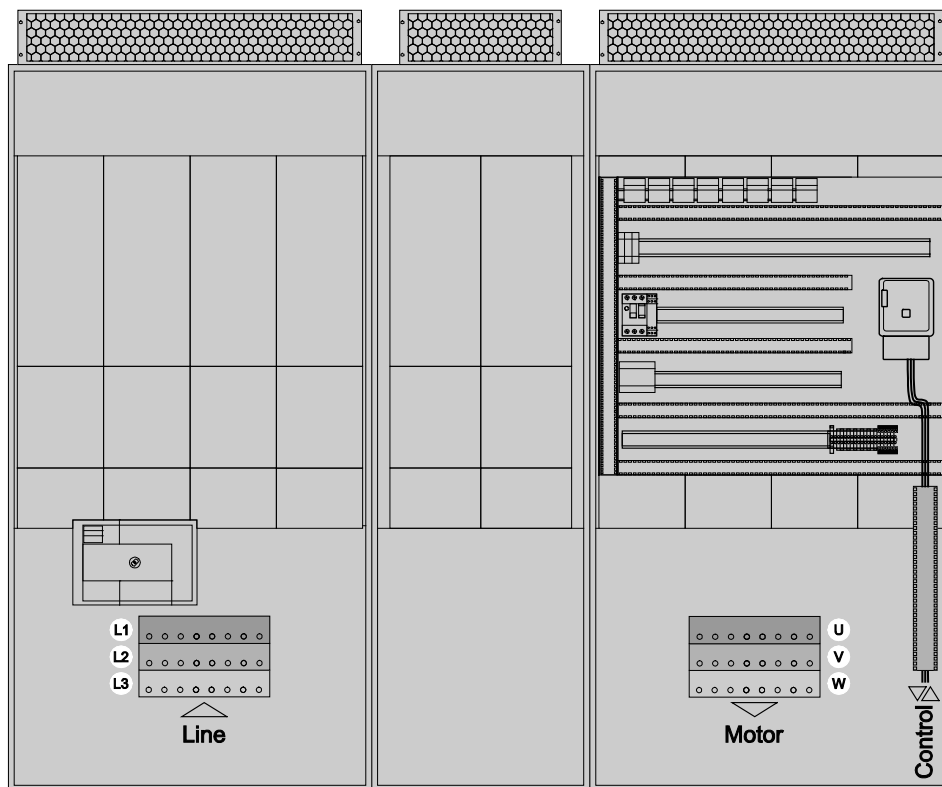

**NOTE:** Following customizations affect the total dimensions:

- Increased protection degree IP54
- Enclosure plinth for basic device
- Connection enclosure cable from top/bottom

## Technical Data ATV680C80●4X1

Type		ATV680C80●4X1	
Nominal data		Normal Duty ND	Heavy Duty HD <sup>(1)</sup>
Typical motor rating P <sub>n</sub>	U <sub>n</sub> = 400 V	800 kW	630 kW
	U <sub>n</sub> = 440 V	800 kW	630 kW
	U <sub>n</sub> = 480 V	900 kW	710 kW
Rated output current I <sub>n</sub>		1420 A	1140 A
Maximum current I <sub>MAX</sub> for 60 s per 10 minutes		1562 A	1710 A
<b>Input</b>			
Rated input current I <sub>in</sub> (at I <sub>sc</sub> = 50 kA)	U <sub>n</sub> = 400 V	1227 A	971 A
	U <sub>n</sub> = 440 V	1115 A	883 A
	U <sub>n</sub> = 480 V	1150 A	912 A
Rated apparent power S <sub>n</sub>	U <sub>n</sub> = 400 V	850 kVA	673 kVA
	U <sub>n</sub> = 440 V	850 kVA	673 kVA
	U <sub>n</sub> = 480 V	956 kVA	758 kVA
Current harmonic THDi <sup>(2)</sup>		< 5 %	
<b>Protection for upstream cables</b>			
Pre-fuse	U <sub>n</sub> = 400, 440, 480 V	1600 A gG	1250 A gG
Circuit breaker I <sub>therm</sub> / I <sub>mag</sub>		1600 A / 16 kA	1250 A / 16 kA
<b>Internal short-circuit protection</b>			
Fuse	U <sub>n</sub> = 400, 440, 480 V	5x 400 A aR	
<b>Characteristics</b>			
Efficiency at I <sub>n</sub>		0.965	
Heat losses at I <sub>n</sub>	Total losses	32580 W	24580 W
	Control part only	3780 W	2780 W
Weight	Net	1950 kg	
	Gross	2045 kg	
<b>Ambient conditions</b>			
Air flow	Power part	5800 m <sup>3</sup> /h	
	Control part	700 m <sup>3</sup> /h	
Sound pressure level		78 dB(A)	
Rated short-circuit current I <sub>sc</sub>	Minimum <sup>(3)</sup>	20 kA	
	Maximum <sup>(4)</sup>	50 kA (100 ms)	
<b>Mains and motor connection <sup>(5)</sup></b>			
Typical cable		5x (3x 240 mm <sup>2</sup> ) or 6x (3x 185 mm <sup>2</sup> )	4x (3x 240 mm <sup>2</sup> ) or 5x (3x 185 mm <sup>2</sup> ) or 6x (3x 120 mm <sup>2</sup> )
Max. Cable cross section <sup>(6)</sup>	Cable	6x (3x 240 mm <sup>2</sup> ) or 8x (3x 150 mm <sup>2</sup> )	
	Cable entry mains <sup>(7)</sup>	max. 760 mm	
	Cable entry motor <sup>(7)</sup>	max. 760 mm	
Terminals per phase		10x M12	
<p><b>(1)</b> For Heavy Duty HD operation parameter [Dual Rating] <i>drL</i> has to be set to [High rating] <i>HiGH</i> (see programming manual <a href="#">EAV64318</a>).</p> <p><b>(2)</b> For details see table under chapter "Mains Current Harmonics / Mains Voltage Distortion", page 67.</p> <p><b>(3)</b> Minimum mains short-circuit current</p> <p><b>(4)</b> Permitted short-circuit current when the specified pre-fuse or circuit breaker is installed</p> <p><b>(5)</b> You will find further information at chapter "Mains Connection", page 65 and at chapter "Motor Connection", page 68.</p> <p><b>(6)</b> Greater connection cross sections are possible with the separate connection enclosure.</p> <p><b>(7)</b> Maximum possible width of cables connected next to each other in the enclosure</p>			

Dimensions IP23 for Size 5a

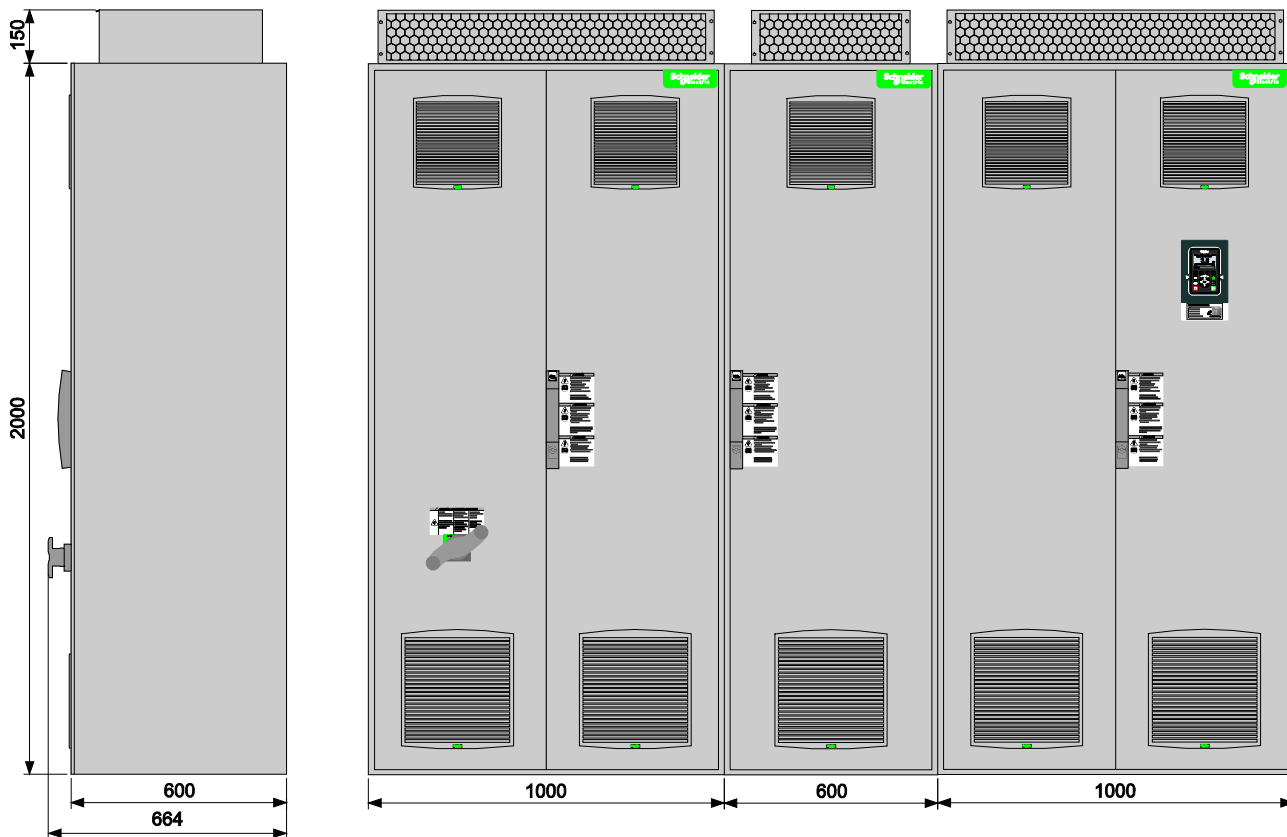

Interior View IP23 for Size 5a

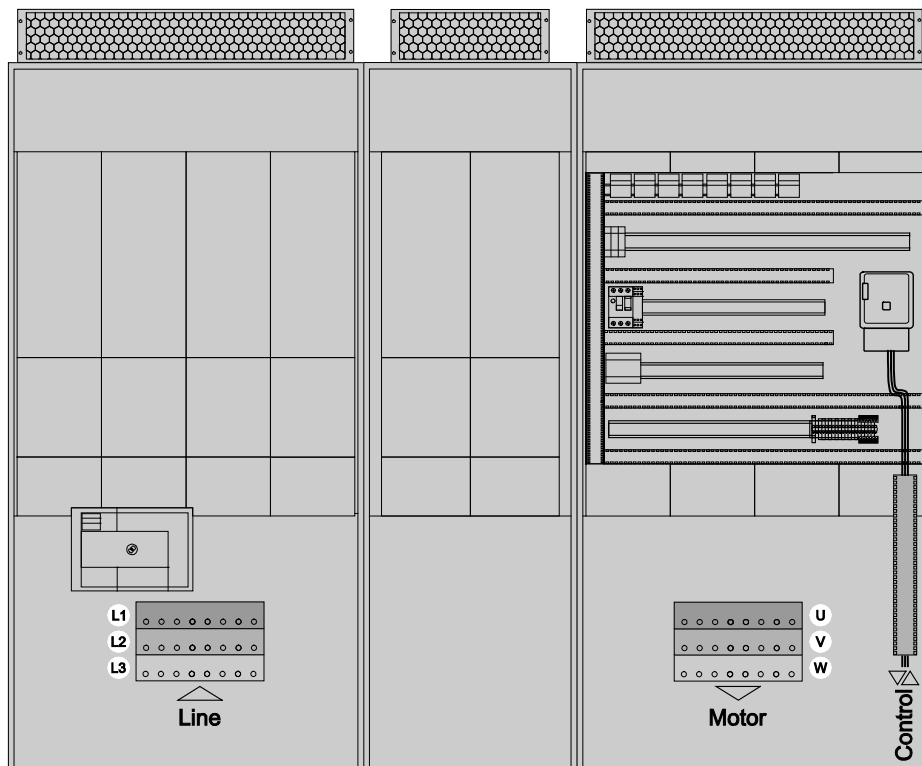

**NOTE:** Following customizations affect the total dimensions:

- Increased protection degree IP54
- Enclosure plinth for basic device
- Connection enclosure cable from top/bottom

## Circuit Diagram

The following diagram shows the typical wiring of the frequency inverter including the options which may be required for protection of the plant or the device, depending on the use case.

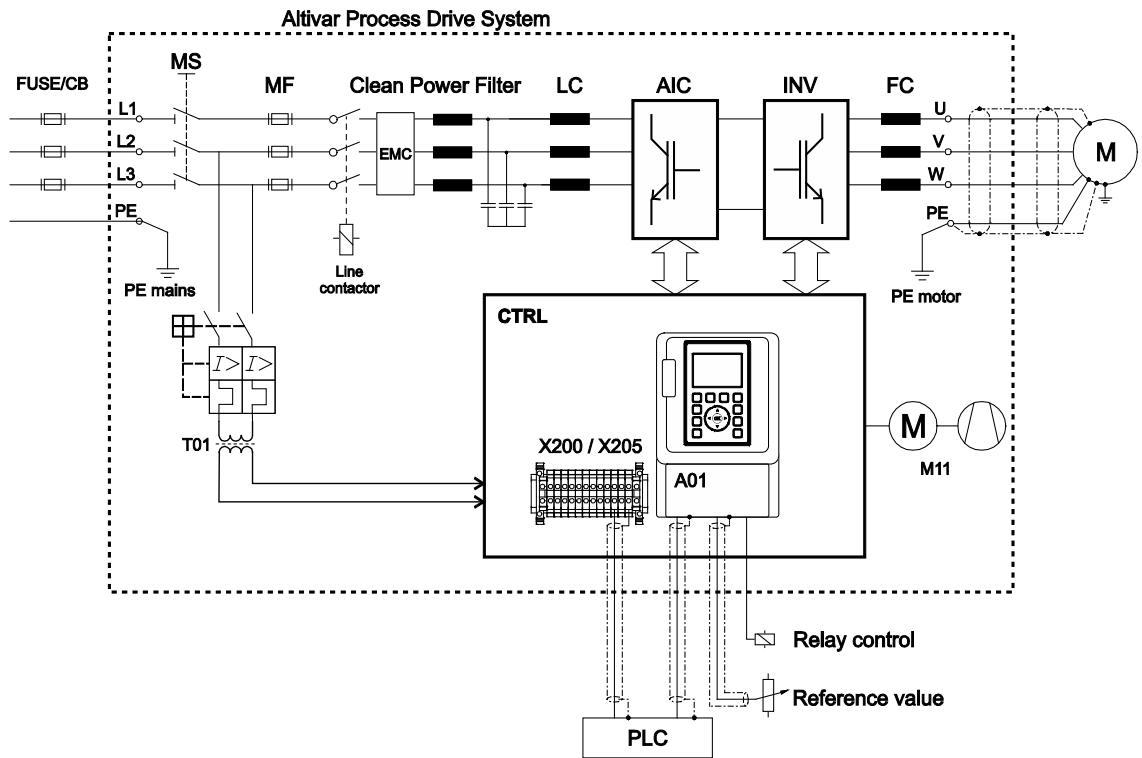

<b>ATV680</b>	Altivar Process Drive Systems
<b>FUSE/CB</b>	External pre-fuse or circuit breaker to protect the mains cable
<b>MS</b>	Built-in main switch, lockable in open position
<b>T01</b>	Control transformer 400 / 230 V AC
<b>MF</b>	aR fuses for short-circuit shut-down if the electronic protective devices do not work properly
<b>Clean Power Filter</b>	Clean Power Filter with integrated EMC filter
<b>LC</b>	Filter choke
<b>AIC</b>	Active Infeed Converter module(s)
<b>INV</b>	Inverter module(s)
<b>FC</b>	dv/dt filter choke to reduce the voltage load of the motor (at some types a "dv/dt filter choke" is already integrated)
<b>CTRL</b>	Control panel with control block and further control components
<b>A01</b>	Control terminals at the control block
<b>X200 / X205</b>	Control terminals at the control panel
<b>M11</b>	Fan in enclosure door





## Mains Connection

### Dimensioning of the Power Cables

The Altivar Process Drive Systems include semiconductor fuses as standard. These fuses are for the case that the electronic protective mechanisms of the inverter do not work. So they are a secondary protection of the inverter.

The Altivar Process Drive Systems help to protect themselves as well as the mains cables and the motor cables against thermal overload. The specified pre-fuses or circuit breakers (with magnetic release) must be installed upstream to protect the mains cables against short-circuit.

The recommended values for dimensioning the cable cross sections given in chapter "Technical data" are reference values for multi-core copper power cables layed in air at a maximum ambient temperature of 40°C. Observe different ambient conditions and local regulations.

Recommended types of mains cables	
	Three-phase cable with sector-shaped conductors and reduced protective conductor <b>NOTE:</b> Check whether the protective conductor complies with the requirements of IEC 61439-1.
	Three-phase cable with round conductors and reduced protective conductor. <b>NOTE:</b> Check whether the protective conductor complies with the requirements of IEC 61439-1.

**NOTE:** The recommended cable cross sections are given at the technical data of the respective Altivar Process Drive System (from page 36).

### **WARNING**

#### **OVERLOAD DUE TO INCORRECT RATING OF MAINS SUPPLY**

- Install properly rated upstream mains fuses or circuit breakers.
- When rating the upstream mains fuses and the cross sections as well as the length of the mains cables, take into account the available specified short circuit current.
- If the required short circuit is not available, increase the power of the transformer.

**Failure to follow these instructions can result in death, serious injury, or equipment damage.**

## Overcurrent- and Short-circuit Protection

The following picture illustrates the overcurrent protection and short-circuit protection at the input side.

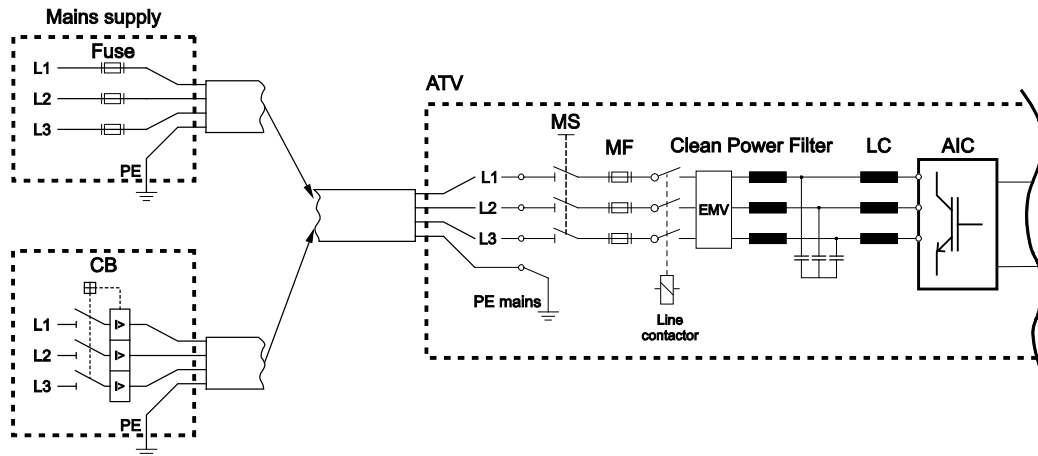

<b>ATV</b>	Altivar Process Drive Systems
<b>FUSE</b>	External pre-fuse to protect the mains cable
<b>CB</b>	External circuit breaker to protect the mains cable (alternatively to FUSE)
<b>MS</b>	Built-in main switch, lockable in open position
<b>MF</b>	aR mains fuses for short-circuit shut-down if the electronic protective devices do not work properly
<b>Clean Power Filter</b>	Clean Power Filter with integrated EMC filter
<b>LC</b>	Filter choke
<b>AIC</b>	Active Infeed Converter module(s)

The Altivar Process Drive System includes semiconductor fuses as standard. These fuses are for the case that the electronic protective mechanisms of the inverter do not work. So they are a secondary protection of the inverter.

**NOTE:** If the mains fuses blow, the inverter already has a primary damage. Therefore, exchanging the blown fuses and switching the inverter on again without any check is not effective.

**NOTE:** The overcurrent protection is given at the technical data of the respective Altivar Process Drive System (from page 36).

## Mains Current Harmonics / Mains Voltage Distortion

Because of using a diode rectifier on the input of a conventional inverter, harmonics occur in the mains current which lead to a voltage distortion of the supplying mains.

The ATV680 Low Harmonic Drive Systems are equipped with an active mains supply module. So these typical harmonic currents of the frequency inverter do not occur anymore.

The new 3-level technology inside the ATV680 Low Harmonic Drive System reaches a total harmonic distortion THD(i) of around 2 % and thus fulfills the requirements according to IEEE 519 of  $THD(i) < 5\%$  also in case of distorted mains. This low total harmonic distortion THD(i) is reached during mains supply operation as well as during regenerating operation.

$\cos \Phi \approx 1$  is reached in each load situation (from 30 %  $P_n$ ) and additionally helps to reduce the load of the mains.

This table represents typical values of the individual current harmonics at operation with the ATV680 Low Harmonic Drive Systems.

Operating mode	Current harmonics in % <sup>(1)</sup>																	
	H1	H5	H7	H11	H13	H17	H19	H23	H25	H29	H31	H35	H37	H41	H43	H47	H49	THD
<b>Motor</b>	<b>100</b>	1.29	1.05	0.38	0.21	0.20	0.19	0.34	0.19	0.11	0.09	0.15	0.12	0.19	0.18	0.07	0.04	<b>2.2</b>
<b>Generator</b>	<b>100</b>	1.26	0.78	0.39	0.33	0.69	0.60	0.28	0.40	0.22	0.22	0.16	0.20	0.18	0.09	0.04	0.04	<b>2.1</b>

(1) Values are valid for operation at nominal load and sinusoidal mains voltage.

## Motor Connection

### Assignment of the Motor

All Altivar Process Drive Systems include the function "Dual rating". It enables the use for drives with low overload "Normal duty" (typically pumps and fans) and, on the other hand, also the use with increased requirements regarding overload capability, starting torque, load impacts and control performance "Heavy duty" (e.g. compressors, mixers, rotary blowers,...).

You can select the desired power/overload capability with parameter [Dual rating] *drL*. When changing this parameter all relevant parameters are adapted to the selected property. For example, the parameters for motor power and motor current are modified accordingly.

In case of setting HD – Heavy Duty [High rating] *HiGH* the overload capability and the maximum overload current are increased. But at the same time the nominal motor power and the continuous output current of the frequency inverter are reduced. So you have to select a higher device type for the same motor power.

#### Example for ATV680C13Q4X1:

##### Normal Duty ND:

132 kW with 250 A continuous current and 275 A overload current for 60 s

- Nominal power
- Overload 10 %
- Factory setting: [Normal rating] *norMAL*

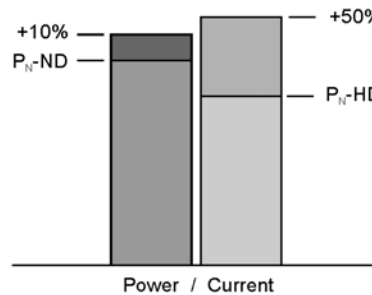

##### Heavy Duty HD:

110 kW with 211 A continuous current and 317 A overload current for 60 s

- Lower nominal power
- Overload 50 %
- Selectable via parameter: [High rating] *HiGH*

The factory setting of the parameter [Dual Rating] *drL* is "Normal Duty". When the product is reset to the factory settings, this parameter is also reset to "Normal Duty".

## Dimensioning of the Motor Cables

The recommended values for dimensioning the cable cross sections given in chapter "Technical data" are reference values for multi-core copper power cables layed in air at a maximum ambient temperature of 40°C. Observe different ambient conditions and local regulations.

**NOTE:** The recommended cable cross sections are given at the technical data of the respective Altivar Process Drive System (from page 36).

The motor cables are dimensioned for the maximum continuous current. They apply to 0...100 Hz (up to 300 Hz the cable losses increase about 25 % because of the Skin-effect).

The IGBT modules cause high-frequent interferences which drain off more and more stronger to the ground potential with increasing motor cable length. As a result the line-conducted interferences to the mains increase. In case of too long motor cables the attenuation of the mains filters is not longer sufficient and the permitted interference limits are exceeded.

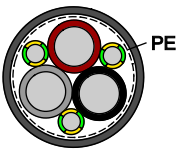
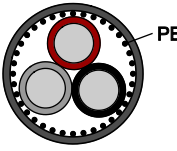
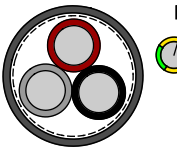
Recommended types of motor cables	
	<p>Symmetrically shielded cable with three phase conductors, symmetrically arranged PE conductor and a shield.</p> <p><b>NOTE:</b> Check that the PE conductor complies with the requirements according to IEC 61439-1.</p> <p><b>Example:</b> 2YSLCY-JB</p>
	<p>Symmetrically shielded cable with three phase conductors and a concentric PE conductor as shield.</p> <p><b>NOTE:</b> Check that the shield (PE conductor) complies with the requirements according to IEC 61439-1.</p> <p><b>Example:</b> NYCY / NYCWY</p>
	<p>Symmetrically shielded cable with three phase conductors.</p> <p><b>NOTE:</b> A separate PE conductor is required if the shield does not fulfill the requirements according to IEC 61439-1.</p>

**NOTE:** Shielded single-conductor cables are not recommended due to increased currents in the shield.

## DANGER

### ELECTRIC SHOCK DUE TO OVERLOAD ON MOTOR CABLES

- Verify that the protective conductor complies with the requirements of the standard IEC 61439-1.
- Observe the recommendations for motor power cables described in the standard IEC 60034-25.

**Failure to follow these instructions will result in death or serious injury.**

**Length of Motor Cables**

Because of the permitted mains disturbances, the allowed overvoltages at the motor, the occurring bearing currents and the permitted heat losses the distance between inverter and motor(s) is limited. The maximum distance heavily depends on the used motors (insulation material), the type of motor cable used (shielded/unshielded), the cable laying (cable channel, underground installation, ...) as well as from the used options.

**Dynamic voltage load of the motor**

Overvoltages at the motor terminals result from reflection in the motor cable. Basically the motors are stressed with measurable higher voltage peaks from a motor cable length of 10 m. With the length of the motor cable also the value of overvoltage increases.

The steep edges of the switching impulses at the output side of the frequency inverter lead to a further load of the motors. The slew rate of the voltage is typically over 5 kV/μs but it decreases with the length of the motor cable.

The ATV680 frequency inverters are equipped with a dv/dt filter choke (at higher types a "dv/dt filter choke" is already integrated), which significantly reduces the load of the motors and so it is in accordance with the allowed limits.

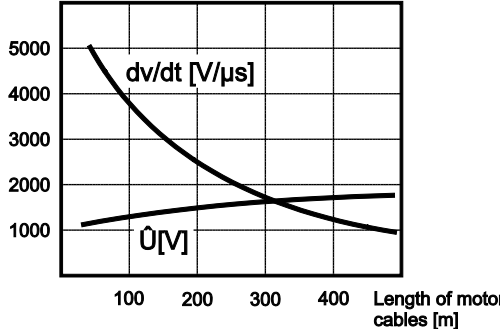
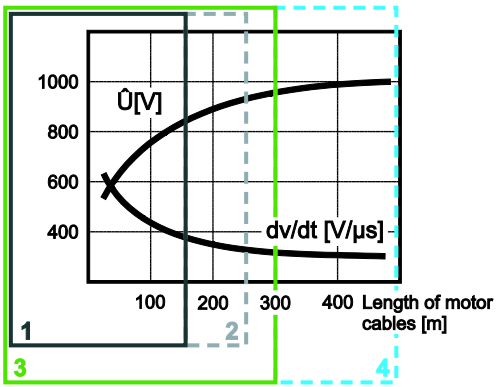
Typical load of the motor <sup>(1)</sup>	Description
 <p>The graph plots dv/dt [V/μs] and U [V] against the length of motor cables [m]. The x-axis ranges from 0 to 400 m. The y-axis for dv/dt ranges from 0 to 5000 V/μs, and for U [V] from 0 to 5000 V. The dv/dt curve starts at 5000 V/μs at 0 m and decreases to approximately 1000 V/μs at 400 m. The U curve starts at 1000 V at 0 m and increases to approximately 2000 V at 400 m.</p>	<p>Load of the motor with overvoltage and slew rate when using conventional frequency inverters without integrated dv/dt filter chokes.</p>
 <p>This graph shows U [V] and dv/dt [V/μs] vs Length of motor cables [m]. The x-axis ranges from 0 to 400 m. The y-axis for U [V] ranges from 0 to 1000 V, and for dv/dt [V/μs] from 0 to 1000 V/μs. The U curve starts at 600 V at 0 m and increases to 1000 V at 400 m. The dv/dt curve starts at 1000 V/μs at 0 m and decreases to approximately 300 V/μs at 400 m. Four regions are highlighted: 1 (0-150 m, U &lt; 600 V), 2 (150-300 m, U &lt; 600 V), 3 (0-300 m, U &lt; 600 V), and 4 (300-400 m, U &lt; 600 V).</p>	<p>Reduced load of the motor by using Altivar Process Drive Systems with integrated dv/dt filter chokes 150 m (at higher types a "dv/dt filter choke" is already integrated).</p> <ol style="list-style-type: none"> <li>1 When using a shielded motor cable</li> <li>2 When using an unshielded motor cable</li> <li>3 When using a shielded motor cable and a "dv/dt filter choke 300 m".</li> <li>4 When using an unshielded motor cable and a "dv/dt filter choke 300 m".</li> </ol>
<p>(1) The given values are related to the voltage load phase-to-phase. The voltage values phase to ground are approximately 300 V lower, du/dt is approximately 150 V/μs lower.</p>	

The motor standards for IEC and NEMA specify limits for the permitted load regarding slew rate and voltage peaks.

- IEC 60034-17 – Permitted values for standard power supply driven motors at the frequency inverter, up to 500 V
- IEC 60034-25 – Permitted values for "inverter motors" up to 500 V
- NEMA MG1 – Permitted values for "inverter motors"

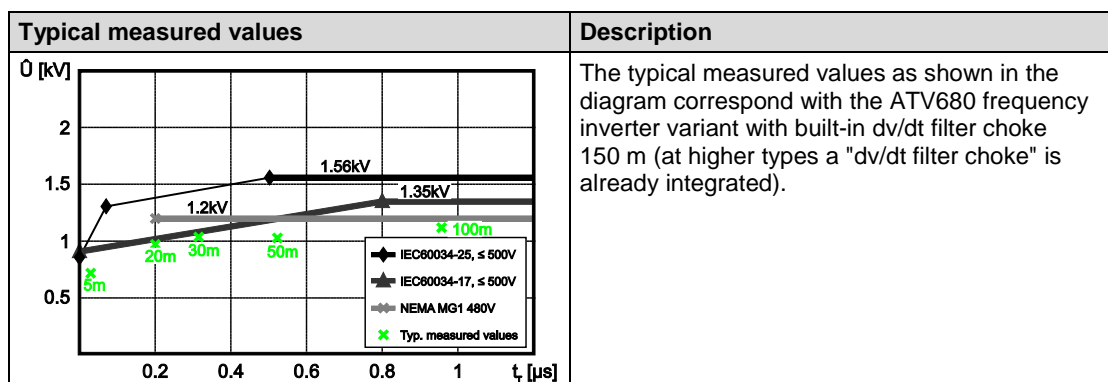

Motors according IEC 60034-25 as well as motors according NEMA MG1 are dimensioned for operation with frequency inverters and thus they are well qualified for drives with ATV680 frequency inverters.

Motors according IEC 60034-17 are dimensioned for operation with pure sinusoidal voltage, but they can also be operated at ATV680 when observing the permitted cable lengths and correct customization.

The Low Harmonic Drive Systems ATV680 and ATV980 offer significant improvement regarding motor load in comparison with older generations with active mains rectifiers AFE (as still offered from many competitors). By the new "3-level" system architecture the voltage load is the same as for ATV660 and ATV960 with classic diode rectifiers and so it not required to take it into account separately.

Basically for all motors from frame size 315 (approximately 110 kW) an insulated bearing on the non-drive end is recommended. It helps to prevent internal current flow inside the motor which can result from unbalances. The insulated bearing is to be understood as supplement to the dv/dt filter choke inside the frequency inverter.

## NOTICE

### OVERVOLTAGE AT THE MOTOR

Do not exceed the maximum length of the motor cables as specified in this document.

**Failure to follow these instructions can result in equipment damage.**

**EMC interferences**

The IGBT modules cause high-frequent interferences which drain off more and more stronger to the ground potential with increasing motor cable length. As a result the line-conducted interferences to the mains increase. In case of too long motor cables the attenuation of the mains filters is not longer sufficient and the permitted interference limits are exceeded.

The IGBT modules cause high-frequency interference which increases with increasing motor cable length. If the motor cable length exceeds the maximum cable length, the internal mains filters are no longer sufficient.

 **WARNING****UNEXPECTED EQUIPMENT OPERATION DUE TO HIGH-FREQUENCY INTERFERENCE**

Do not exceed the maximum length of the motor cables as specified in this document.

**Failure to follow these instructions can result in death, serious injury, or equipment damage.**

This product meets the EMC requirements according to the standard IEC 61800-3 if the measures described in this manual are implemented during installation.

If the selected composition (product itself, mains filter, other accessories and measures) does not meet the requirements of category C1, the following information applies as it appears in IEC 61800-3:

 **WARNING****RADIO INTERFERENCE**

In a domestic environment this product may cause radio interference in which case supplementary mitigation measures may be required.

**Failure to follow these instructions can result in death, serious injury, or equipment damage.**

**Bearing currents**

The dv/dt filter choke inside the ATV680 frequency inverter effects a significant reduction of the common mode bearing currents.

Especially in case of big motors with middle up to high motor cable lengths the filter chokes are considerable to increase the availability of the motor.



### Multiplication factors

In case of conditions differing from the table the recommended cable lengths have to be converted by means of the following factors.

If several factors apply, please multiply them.

		Correction of the max. cable lengths
The pulse frequency does not correspond to factory setting:	at 4 kHz	multiply all values by 0.70
	at 8 kHz	multiply all values by 0.40
Output frequencies higher than 100 Hz.	up to 200 Hz	multiply all values by 0.80
	up to 300 Hz	multiply all values by 0.50
In case of 6-pole motor cabling (e.g. for star/delta starting circuit)		multiply all values by 0.75
In case of parallel motors with a dedicated cable to each motor the inverter values have to be converted in compliance with the number of motors. When a motor choke is used for each motor, the following values in brackets apply.	at 2 motors	multiply all values by 0.40 (0.80)
	at 3 motors	multiply all values by 0.25 (0.60)
	at 4 motors	multiply all values by 0.15 (0.40)
	at 5 motors	multiply all values by 0.10 (0.25)
In case of parallel motors with a common cable to all motors the inverter values have to be converted in compliance with the number of motors:	at 2 motors	multiply all values by 0.80
	at 3 motors	multiply all values by 0.60
	at 4 motors	multiply all values by 0.40
	at 5 motors	multiply all values by 0.25

### Recommended maximum lengths of motor cables in second environment (industrial environment)

EMC category (EN 61800-3)	ATV680	Chosen option	Type of cable	Max. cable length
C3	C11●4X1...C16●4X1	–	Shielded	50 m
	C11●4X1...C16●4X1	dv/dt filter choke 150m	Shielded	150 m
	C20●4X1...C80●4X1	– <sup>(1)</sup>	Shielded	150 m
C4	C11●4X1...C16●4X1	–	Unshielded	100 m
	C11●4X1...C16●4X1	dv/dt filter choke 150m	Unshielded	250 m
	C20●4X1...C80●4X1	– <sup>(1)</sup>	Unshielded	250 m
	C11●4X1...C80●4X1	dv/dt filter choke 300m	Shielded	300 m
	C11●4X1...C80●4X1	dv/dt filter choke 300m	Unshielded	500 m
<b>(1)</b> At ATV680 Drive Systems from 200 kW the dv/dt filter choke 150m is built-in as standard.				

**NOTE:** The specified lengths of motor cables are recommended limits based on typical motor cables, laying in cable channels, default pulse frequency and maximal output frequency of 100 Hz. Longer cable lengths are possible on request.

## Thermal Motor Monitoring

In the Altivar Process Drive System several possibilities for thermal motor monitoring are available:

- Standard sensor inputs AI2, AI3 at the control block  
Suitable temperature sensors: PTC, Pt100, Pt1000, KTY84
- Sensor inputs AI4, AI5 at expansion card "Logic and analog I/O card"  
Suitable temperature sensors: PTC, Pt100, Pt1000, KTY84

### DANGER

#### HAZARD OF ELECTRIC SHOCK, EXPLOSION OR ARC FLASH

- Verify that the temperature sensors in the motor meet the PELV requirements.
- Verify that the motor encoder meets the PELV requirements.
- Verify that any other equipment connected via signal cables meets the PELV requirements.

**Failure to follow these instructions will result in death or serious injury.**

- On customer request the motor monitoring PTC, a PTC thermistor relay (alternatively with ATEX certificate), is installed and the sensor inputs are wired with the option terminals. The evaluation is performed via the diagnostics system in the Altivar Process Drive System.
- On customer request the motor/bearing monitoring Pt100/Pt1000/KTY is installed, which includes evaluation relays and the wiring of the sensor inputs to the option terminals. The evaluation is performed via the diagnostics system in the Altivar Process Drive System.

**NOTE:** When protective separation of the thermistor sensors in the motor cannot be guaranteed or in case of long motor cables, this option is highly recommended.

## Customizations

### Predefined Customizations

Customization	Brief description	Page
<b>Enclosure options</b>		
Increased protection degree IP54	Enclosure designed in increased protection degree IP54	94
Enclosure plinth	Enclosure plinth for basic device in protection degree IP23	95
Connection enclosure	Separate connection enclosure; for connection of cables alternatively from top or from bottom.	95
Enclosure lighting	Fluorescent lamp and a power socket 230 V AC	96
Enclosure heating	Heats the enclosure in order to avoid frost and condensation at an ambient temperature up to -10°C	96
Modified wiring colors	Modified wiring colors at the power cables	97
<b>Control options</b>		
Key switch "local / remote"	Key switch in the enclosure door for switching between remote control and local control	98
Ethernet port on front door	Access to the Ethernet network directly on the enclosure door	98
<b>I/O expansion cards</b>		
Logic and analog I/O card	Expansion card for additional analog and digital inputs and outputs (6 digital inputs, 2 digital outputs, 2 analog inputs)	99
Relay output card	Expansion card with three additional relay outputs	99
<b>Communication cards</b>		
Communication card Modbus TCP or EtherNet IP	Dual port option card for control of the inverter via Modbus TCP or EtherNet/IP	100
Communication card CANopen Daisy Chain	Option card for control of the inverter via CANopen Daisy Chain	100
Communication card CANopen SUB-D9	Option card for control of the inverter via CANopen with SUB-D port	100
Communication card CANopen with screw terminals	Option card for control of the inverter via CANopen with screw terminals	100
Communication card DeviceNet	Option card for control of the inverter via DeviceNet	100
Communication card Profibus DP	Option card for control of the inverter via Profibus DP V1	101
Communication card PROFINET	Option card for control of the inverter via PROFINET	101
<b>Functional safety</b>		
STO - SIL 3 Stop category 0	This option effects a Safe Torque Off at the motor	102
STO - SIL 3 Stop category 1	This option effects a Safe Torque Off at the motor with controlled deceleration	102
<b>Display options</b>		
Front Display Module (FDM)	Measuring device mounted in the enclosure door which indicates the operating data	103
Indicator lamps on front door	Three additional Indicator lamps mounted in the enclosure door which indicate the operating state	103

<b>Customization</b>	<b>Brief description</b>	<b>Page</b>
<b>Motor options</b>		
Motor monitoring PTC	PTC thermistor relay to monitor the motor temperature via PTC thermistors in the motor	104
Motor monitoring PTC with ATEX certificate	PTC thermistor relay to monitor the motor temperature via PTC thermistors in the motor with ATEX certificate	104
Motor monitoring Pt100/Pt1000/KTY	Tripping unit to monitor the motor temperature via Pt100/Pt1000/KTY sensors in the motor winding	104
Bearing monitoring Pt100/Pt1000/KTY	Tripping unit to monitor the motor temperature via Pt100/Pt1000/KTY sensors in the bearings of the motor	105
dv/dt filter choke 150 m	Reduces the slew rate, peak voltage and common mode interferences on the output of the inverter and helps to protect the motor	105
dv/dt filter choke 300 m	Helps to protect the motor winding and motor bearings in case of very long motor cable	105
Motor heating	Includes a motor circuit breaker, a contactor and the terminals to connect a motor heating	105
<b>Mains supply</b>		
Circuit breaker	Mains disconnect unit instead of the main switch, including door handle	106
Undervoltage coil for circuit breaker 230 V	When there is no voltage at the undervoltage coil, the circuit breaker switches off	106
Motor for circuit breaker 230 V	Remote control of the circuit breaker via control commands is possible by means of this motor drive.	107
<b>Monitoring</b>		
Remote monitoring	Records the data of the Drive Systems and provides them in the Schneider Electric StruxureWare Energy Operation Network.	108
<b>Packaging</b>		
Safety labels in local language	With this option the devices can be ordered with labels in the local language.	109
Seaworthy packaging	This option contains a seaworthy packaging for transport by ship.	109

---

# Chapter 4

## Wiring of the Control Terminals

---

### What Is in This Chapter?

This chapter contains the following topics:

Topic	Page
Design/Position of the Individual Terminals	78
Control Block	79
Option "Logic and Analog I/O Card"	86
Option "Relay Output Card"	89
Option Terminals	90

## Design/Position of the Individual Terminals

The Altivar Process Drive Systems are already equipped with extensive terminals on the control block as standard. The use and the function of all inputs and outputs can be parameterized.

In addition, there are the terminals X200 and X205, which are wired internally appropriate to the customizations.

For expansion the option cards Logic and analog I/O card and the relay output card are available. Both expansion cards can be installed, but the same card cannot be plugged twice.

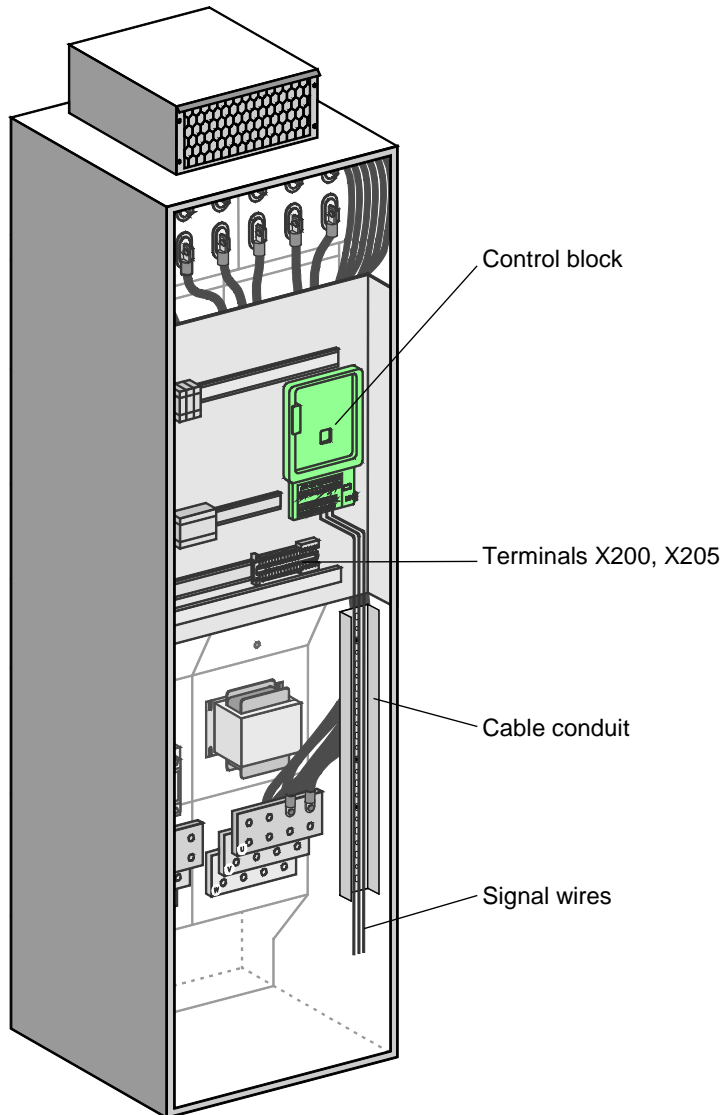

## Voltage Supply and Auxiliary Voltage

All Drive Systems are equipped with a control transformer matching with the mains voltage and the required power. It provides a 230 V AC control voltage for supplying the fans in the enclosure doors and the DC supply units.

The DC supply units generate 48 V DC for the internal power part fans and a 24 V DC auxiliary voltage. All control components are supplied by the internally provided voltages.

**NOTE:** For buffering the control block and with that keeping communication alive (e.g. fieldbus), the control block can be supplied via the terminals P24 and 0V externally with 24 V DC.

## Control Block

### Structure of the Control Block

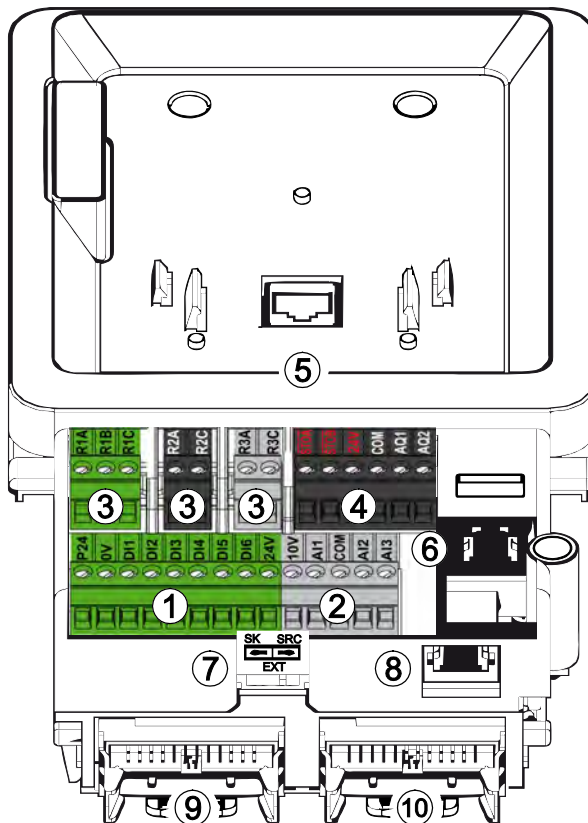

- 1 Control terminals of digital inputs
- 2 Control terminals of analog inputs
- 3 Control terminals of relay outputs
- 4 Control terminals STO (Safe Torque Off) and analog outputs
- 5 RJ45 port for the graphical keypad
- 6 RJ45 port for Ethernet IP or Modbus TCP
- 7 Sink-Ext-Source selector switch
- 8 RJ45 port for serial Modbus
- 9 Slot B for I/O expansion card
- 10 Slot A for communication card or I/O expansion card

Control Terminals at the Control Block

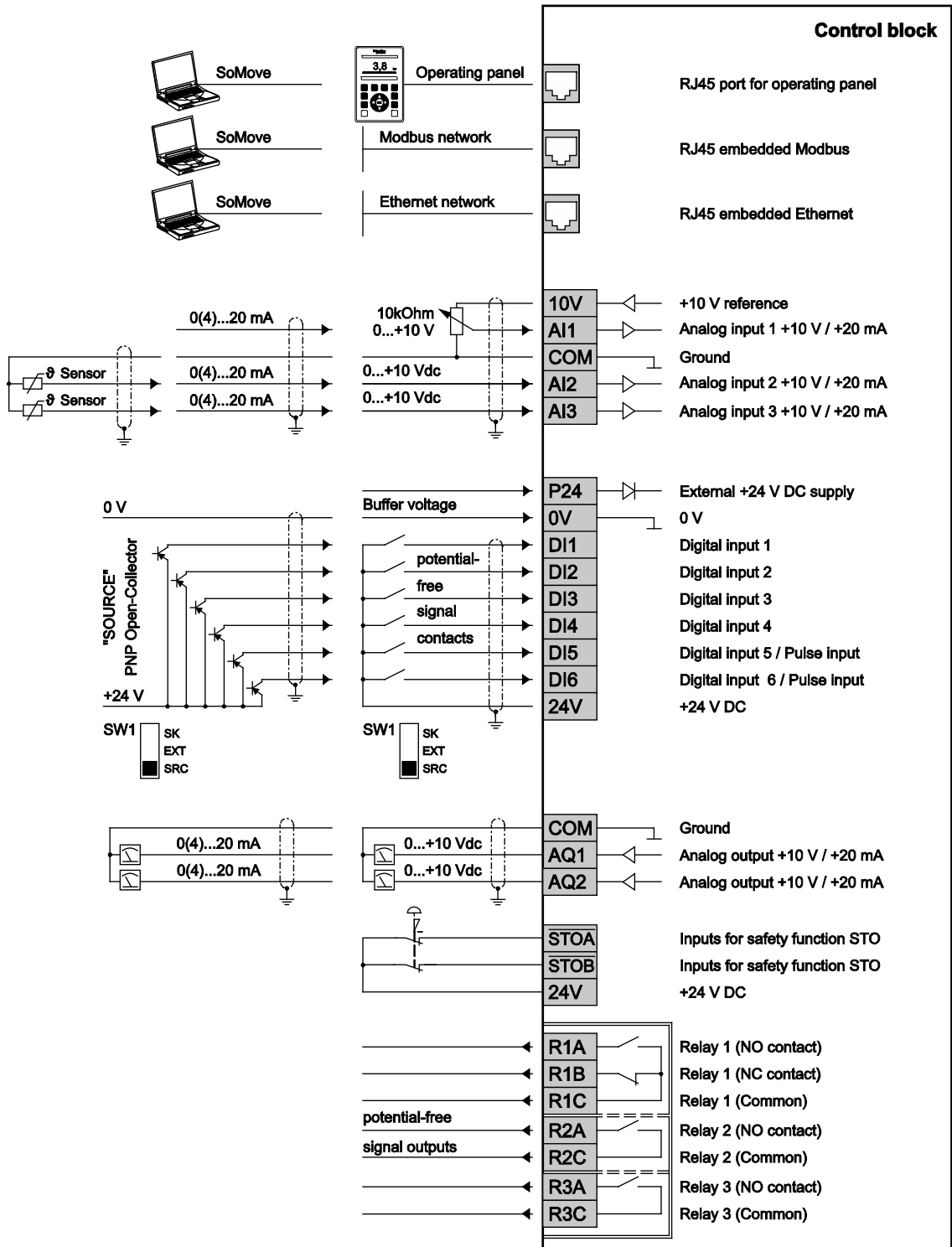



## Specification of the Control Terminals

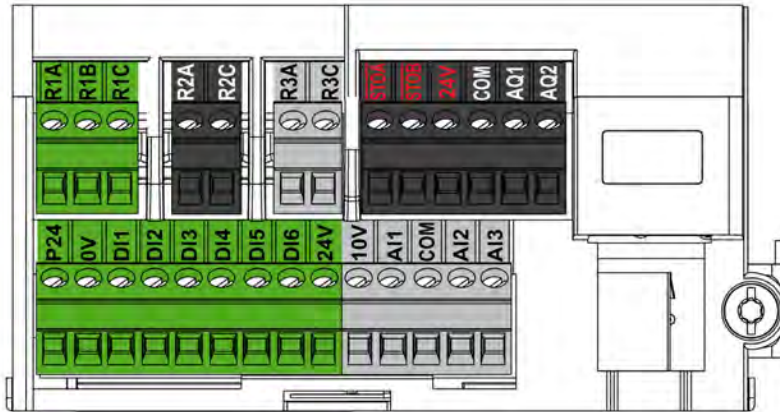

### Screw terminals

Maximum cable cross section for all terminals: 1.5 mm<sup>2</sup> (AWG 16), 0.25 Nm

Minimum cable cross section:

- For relay terminals 0.75 mm<sup>2</sup>(AWG 18)
- For all other terminals 0.5 mm<sup>2</sup>(AWG 20)

Strip length: 10 mm

Maximum cable length:

- AI●, AQ●, DI●, DQ●: 50 m shielded
- $\overline{\text{STOA}}$ ,  $\overline{\text{STOB}}$ : 30 m unshielded

Terminal	Description	Specification
R1A R1B R1C	Relay output 1 (R1A NO contact, R1B NC contact)	<ul style="list-style-type: none"> <li>• Minimum switching capacity: 5 mA for 24 V DC</li> <li>• Maximum switching capacity on resistive load (<math>\cos \varphi = 1</math>): 3 A for 250 V AC and 30 V DC</li> <li>• Maximum switching capacity on inductive load (<math>\cos \varphi = 0.4</math> and <math>L/R = 7</math> ms): 2 A for 250 V AC and 30 V DC</li> <li>• Response time: 5 ms <math>\pm</math> 0.5 ms</li> <li>• Life cycle: 100,000 switching cycles at max. switching capacity</li> </ul>
R2A R2C	Relay output 2 (NO contact)	<ul style="list-style-type: none"> <li>• Minimum switching capacity: 5 mA for 24 V DC</li> <li>• Maximum switching capacity on resistive load (<math>\cos \varphi = 1</math>): 3 A for 250 V AC and 30 V DC</li> <li>• Maximum switching capacity on inductive load (<math>\cos \varphi = 0.4</math> and <math>L/R = 7</math> ms): 2 A for 250 V AC and 30 V DC</li> <li>• Response time: 5 ms <math>\pm</math> 0.5 ms</li> <li>• Life cycle: 100,000 switching cycles at max. switching capacity</li> </ul>
R3A R3C	Relay output 3 (NO contact)	<ul style="list-style-type: none"> <li>• Minimum switching capacity: 5 mA for 24 V DC</li> <li>• Maximum switching capacity on resistive load (<math>\cos \varphi = 1</math>): 3 A for 250 V AC and 30 V DC</li> <li>• Maximum switching capacity on inductive load (<math>\cos \varphi = 0.4</math> and <math>L/R = 7</math> ms): 2 A for 250 V AC and 30 V DC</li> <li>• Response time: 5 ms <math>\pm</math> 0.5 ms</li> <li>• Life cycle: 100,000 switching cycles at max. switching capacity</li> </ul>
$\overline{\text{STOA}}$ , $\overline{\text{STOB}}$	STO inputs	Inputs of the safety function STO See "Safety Function Manual (EAV64334)" available on <a href="http://www.schneider-electric.com">www.schneider-electric.com</a> .
24V	Sampling voltage for STO inputs	+24 V DC for STO inputs $\overline{\text{STOA}}$ and $\overline{\text{STOB}}$

Terminal	Description	Specification
COM	Ground for analog I/O	0 V reference potential for analog outputs
AQ1	Analog output AQ1	Analog output configurable for voltage or current by software <ul style="list-style-type: none"> <li>• Analog voltage output 0...10 V DC, min. load impedance 470 <math>\Omega</math></li> <li>• Analog current output freely programmable from 0...20 mA, max. load impedance 500 <math>\Omega</math></li> <li>• Max. sampling period: 10 ms <math>\pm</math> 1 ms</li> <li>• Resolution 10 bits</li> <li>• Accuracy: <math>\pm</math> 1 % for a temperature variation of 60°C</li> <li>• Linearity <math>\pm</math> 0.2 %</li> </ul>
AQ2	Analog output AQ2	
P24	External input supply	External input supply +24 V DC <ul style="list-style-type: none"> <li>• Tolerance: min. 19 V DC, max. 30 V DC</li> <li>• Current: max. 0.8 A</li> </ul>
0V	Ground	0 V for external supply P24
DI1...DI6	Digital inputs	6 programmable digital inputs 24 V DC, comply with IEC/EN 61131-2 logic type 1 <ul style="list-style-type: none"> <li>• Positive logic (Source): state 0 when <math>\leq</math> 5 V DC or digital input not wired, state 1 when <math>\geq</math> 11 V DC</li> <li>• Negative logic (Sink): state 0 when <math>\geq</math> 16 V DC or digital input not wired, state 1 when <math>\leq</math> 10 V DC</li> <li>• Impedance 3.5 k<math>\Omega</math></li> <li>• Maximum voltage: 30 V DC</li> <li>• Max. sampling period: 2 ms <math>\pm</math> 0.5 ms</li> </ul> Multiple assignment makes it possible to configure several functions on one input (example: DI1 assigned to forward and preset speed 2, DI3 assigned to reverse and preset speed 3).
DI5...DI6	Pulse inputs	Programmable pulse inputs <ul style="list-style-type: none"> <li>• Comply with level 1 PLC standard IEC 65A-68</li> <li>• State 0 when <math>\leq</math> 0.6 V DC, state 1 when <math>\geq</math> 2.5 V DC</li> <li>• Pulse counter 0...30 kHz</li> <li>• Frequency range: 0...30 kHz</li> <li>• Duty cycle: 50 % <math>\pm</math> 10 %</li> <li>• Maximum input voltage: 30 V DC, &lt; 10 mA</li> <li>• Max. sampling period: 5 ms <math>\pm</math> 1 ms</li> </ul>
24V	Sampling voltage for digital inputs	<ul style="list-style-type: none"> <li>• +24 V DC</li> <li>• Tolerance: min. 20.4 V DC, max. 27 V DC</li> <li>• Current: max. 200 mA for both 24 V terminals</li> <li>• Terminal protected against overload and short-circuit</li> <li>• When the selector switch is in position "Ext", this supply is powered by an external PLC.</li> </ul>
10V	Sampling voltage for analog inputs	Internal supply for reference potentiometer (1...10 k $\Omega$ ) <ul style="list-style-type: none"> <li>• 10.5 V DC</li> <li>• Tolerance: <math>\pm</math> 5 %</li> <li>• Current: max. 10 mA</li> <li>• Short-circuit protected</li> </ul>
AI1...AI3	Analog inputs	Three analog input configurable for voltage or current by parameter <ul style="list-style-type: none"> <li>• Analog voltage input 0...10 V DC, impedance 30 k<math>\Omega</math></li> <li>• Analog current input freely programmable from 0...20 mA, impedance 250 <math>\Omega</math></li> <li>• Max. sampling period: 5 ms <math>\pm</math> 1 ms</li> <li>• Resolution 12 bits</li> <li>• Accuracy: <math>\pm</math> 0.6 % for a temperature variation of 60°C</li> <li>• Linearity <math>\pm</math> 0.15 % of maximum value</li> </ul>
COM	Ground for analog I/O	0 V reference potential for analog outputs

Terminal	Description	Specification
AI2, AI3	Sensor inputs	Pt100, Pt1000, KTY84, PTC or water level sensor configurable by software <ul style="list-style-type: none"> <li>● <b>Pt100</b> <ul style="list-style-type: none"> <li>● 1 or 3 temperature sensors per analog input (configurable by software)</li> <li>● Sensor current: 5 mA</li> <li>● Range -20...200°C</li> <li>● Accuracy: <math>\pm 4</math> C for a temperature variation of 60°C</li> </ul> </li> <li>● <b>Pt1000, KTY84</b> <ul style="list-style-type: none"> <li>● 1 (Pt1000, KTY84) or 3 (Pt1000) temperature sensors in series per analog input (configurable by software)</li> <li>● Temperature sensor current: 1 mA</li> <li>● Range -20...200°C</li> <li>● Accuracy: <math>\pm 4</math> C for a temperature variation of 60°C</li> </ul> </li> <li>● <b>PTC</b> <ul style="list-style-type: none"> <li>● 1 to 6 sensors in series</li> <li>● Sensor current: 1 mA</li> <li>● Nominal value: <math>&lt; 1.5</math> k<math>\Omega</math></li> <li>● Overheat trigger threshold: <math>2.9</math> k<math>\Omega</math> <math>\pm 0.2</math> k<math>\Omega</math></li> <li>● Overheat reset threshold: <math>1.575</math> k<math>\Omega</math> <math>\pm 0.75</math> k<math>\Omega</math></li> <li>● Threshold for low impedance: <math>50</math> k<math>\Omega</math> -<math>10</math> <math>\Omega</math>/<math>+20</math> <math>\Omega</math></li> <li>● Short-circuit detection threshold: <math>&lt; 1</math> k<math>\Omega</math></li> </ul> </li> <li>● <b>Water level sensor</b> <ul style="list-style-type: none"> <li>● Sensitivity: <math>0...1</math> M<math>\Omega</math>, adjustable by software</li> <li>● Water level sensor current: <math>0.3...1</math> mA maximum</li> <li>● Adjustable delay time: <math>0...10</math> s</li> </ul> </li> </ul>

## DANGER

### HAZARD OF ELECTRIC SHOCK, EXPLOSION OR ARC FLASH

- Verify that the temperature sensors in the motor meet the PELV requirements.
- Verify that the motor encoder meets the PELV requirements.
- Verify that any other equipment connected via signal cables meets the PELV requirements.

**Failure to follow these instructions will result in death or serious injury.**

Signal interference can cause unexpected responses of the drive and of other equipment in the vicinity of the drive.

## WARNING

### SIGNAL AND EQUIPMENT INTERFERENCE

- Install the wiring in accordance with the EMC requirements described in this document.
- Verify compliance with the EMC requirements described in this document.
- Verify compliance with all EMC regulations and requirements applicable in the country in which the product is to be operated and with all EMC regulations and requirements applicable at the installation site.

**Failure to follow these instructions can result in death, serious injury, or equipment damage.**

Configuration of the Sink / Source Selector Switch

**⚠ WARNING**

**UNANTICIPATED EQUIPMENT OPERATION**

- If the drive is set to "Sink Int" or "Sink Ext", do not connect the "0 V" terminal to ground or to protective ground.
- Verify that accidental grounding of digital inputs configured for sink logic, caused, for example, by damage to the signal cables, cannot occur.
- Follow all applicable standards and directives such as NFPA 79 and EN 60204 for proper control circuit grounding practices.

**Failure to follow these instructions can result in death, serious injury or equipment damage.**

The switch is used to adapt the operation of the digital inputs to the technology of the signal control. The switch is located below the control terminals (see picture at page 79).

- Set the selector switch to SRC (Source) when using PLC outputs with PNP transistors (factory setting).
- Set the switch to Ext (external) when using PLC outputs with NPN transistors.

Selector Switch in Position SRC (Source) and Internal Voltage Supply of the Digital Inputs

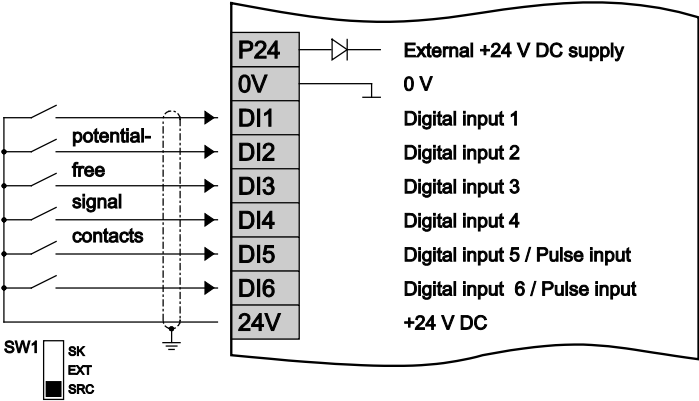

Selector Switch in Position SRC (Source) and External Voltage Supply of the Digital Inputs

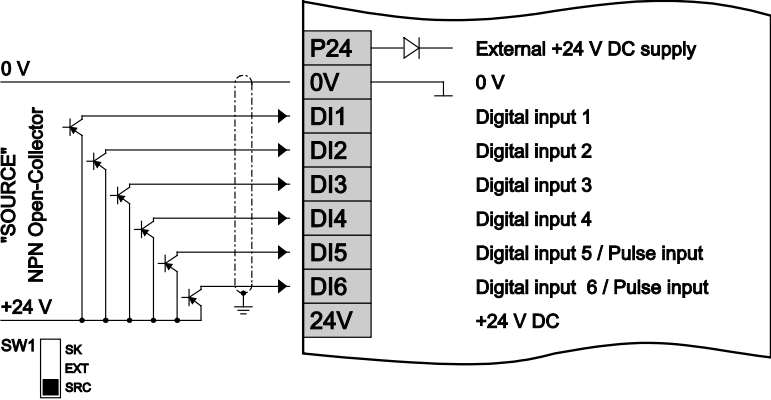

**Selector Switch in Position SK (Sink) and Internal Voltage Supply of the Digital Inputs**

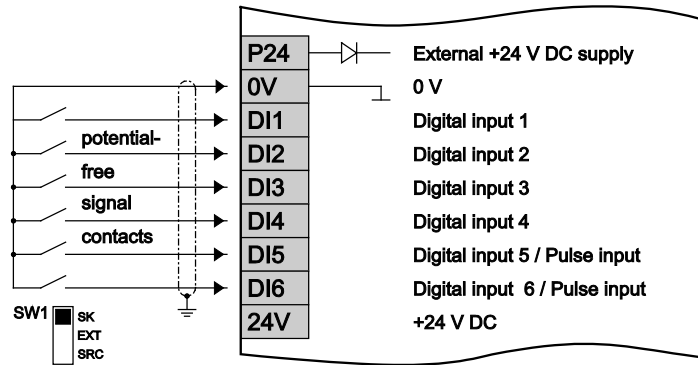

**Selector Switch in Position EXT (external) and External Voltage Supply of the Digital Inputs**

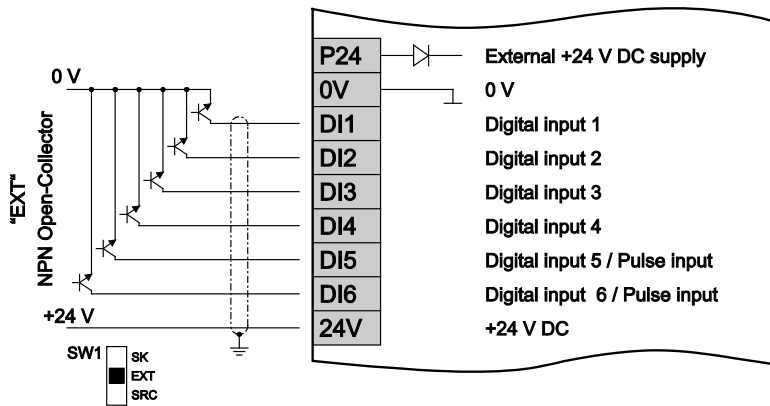

## Option "Logic and Analog I/O Card"

### Control terminals at the expansion card

Option to expand the control inputs and control outputs of the control block. The expansion card contains two analog inputs, six digital inputs and two digital outputs.

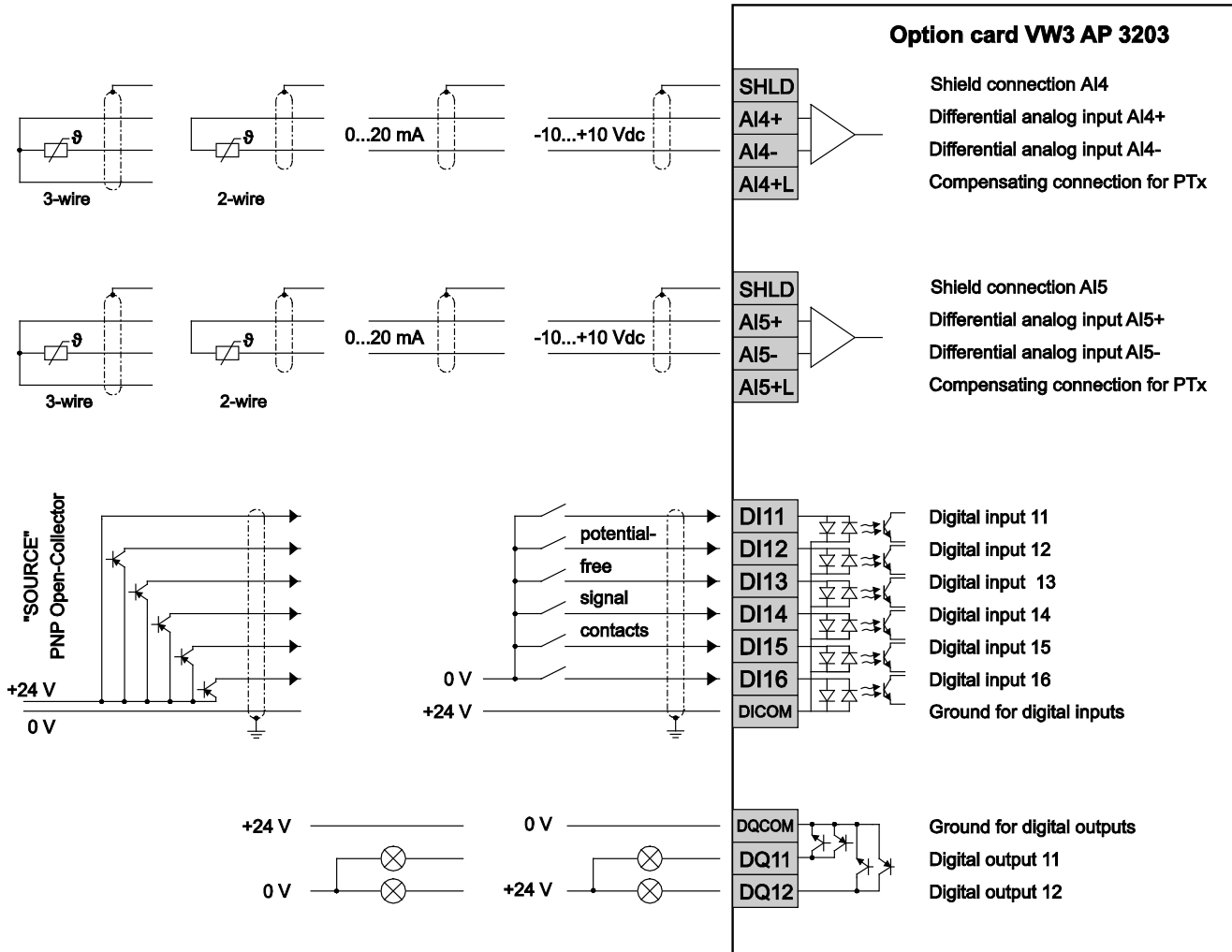

## Specification of the Control Terminals

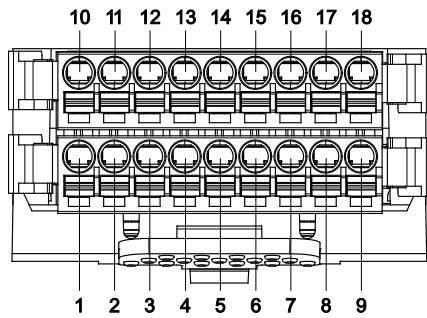

## Spring terminals

Max. cable cross section: 1 mm<sup>2</sup> (AWG 16)

Strip length: 10 mm

Max. cable length AI●, AQ●, DI●, DQ●: 50 m shielded

Pin	Terminal	Description	Specification
1	SHLD	Shield connection for AI4	<p>You can select between voltage, current, Pt100, Pt1000, KTY84 and PTC measurement by software configuration.</p> <p><b>Differential voltage at the input circuit:</b></p> <ul style="list-style-type: none"> <li>Range: -10 V DC...+10 V DC</li> <li>Impedance: 20 kΩ</li> <li>Resolution: 11 bits + 1 sign bit</li> <li>Accuracy: ± 0.6 % for a temperature variation of 60 °C</li> <li>Linearity ± 0.15 % of maximum value</li> </ul> <p><b>Current measurements:</b></p> <ul style="list-style-type: none"> <li>Range: freely programmable from 0...20 mA</li> <li>Impedance: 250 Ω</li> <li>Resolution: 12 bits</li> <li>Accuracy: ± 0.6 % for a temperature variation of 60 °C</li> <li>Linearity ± 0.15 % of maximum value</li> <li>Sampling period: 1 ms</li> </ul> <p><b>PTx measurement:</b></p> <p>Pt100, Pt1000, PTC or KTY84 configurable by software</p> <ul style="list-style-type: none"> <li><b>Pt100</b> <ul style="list-style-type: none"> <li>1 or 3 temperature sensors in series per analog input (configurable by software)</li> <li>Temperature sensor current: max. 7.5 mA</li> <li>Range -20...200 °C</li> <li>Accuracy: ± 3°C for a temperature variation of 60 °C</li> </ul> </li> <li><b>Pt1000, KTY84</b> <ul style="list-style-type: none"> <li>1 (Pt1000, KTY84) or 3 (Pt1000) temperature sensors in series per analog input (configurable by software)</li> <li>Temperature sensor current: max. 1 mA</li> <li>Range -20...200 °C</li> <li>Accuracy: ± 3 °C for a temperature variation of 60 °C</li> </ul> </li> <li><b>PTC</b> <ul style="list-style-type: none"> <li>3 or 6 temperature sensors in series</li> <li>Temperature sensor current: max. 1 mA</li> <li>Nominal value: &lt; 1.5 kΩ</li> <li>Overheat trigger threshold: 2.9 kΩ</li> <li>Overheat reset threshold: 1.575 kΩ</li> <li>Short-circuit detection threshold: &lt; 1 kΩ</li> <li>Wire break detection: &gt; 100 kΩ</li> </ul> </li> </ul>
2	AI4+	<b>Differential analog input 4</b> Depending on software configuration: <ul style="list-style-type: none"> <li>Measurement of differential voltage</li> </ul>	
3	AI4-	<ul style="list-style-type: none"> <li>PTx measurement</li> <li>0...20 mA measurement</li> <li>Reference potential AI4- for AI4+</li> </ul>	
4	AI4+L	Compensating connection for one temperature sensor Pt100, Pt1000 or KTY84 in 3-wire-design	
5	SHLD	Shield connection for AI5	
6	AI5+	<b>Differential analog input 5</b> Depending on software configuration: <ul style="list-style-type: none"> <li>Measurement of differential voltage</li> </ul>	
7	AI5-	<ul style="list-style-type: none"> <li>PTx measurement</li> <li>0...20 mA measurement</li> <li>Reference potential AI5- for AI5+</li> </ul>	
8	AI5+L	Compensating connection for one temperature sensor Pt100, Pt1000 or KTY84 in 3-wire-design	

Pin	Terminal	Description	Specification
9	DQ12	Digital output 12	The 24 V DC digital outputs DQ comply with the standard IEC/EN 61131-2. <ul style="list-style-type: none"> <li>• Logic type selected by DQCOM wiring</li> <li>• Output voltage: <math>\leq 30</math> V DC</li> <li>• Switching capability: <math>\leq 100</math> mA</li> <li>• Voltage drop at 100 mA load: <math>\leq 3</math> V DC</li> <li>• Response time: 1 ms</li> </ul>
10	DICOM	Reference potential for the digital inputs	The 24 V DC digital inputs DI are galvanically isolated via optocoupler and comply with the standard IEC/EN 61131-2. <ul style="list-style-type: none"> <li>• Logic type selected by DICOM wiring</li> <li>• Positive logic (Source): state 0 when <math>\leq 5</math> V DC, state 1 when <math>\geq 11</math> V DC</li> <li>• Negative logic (Sink): state 0 when <math>\geq 16</math> V DC, state 1 when <math>\leq 10</math> V DC</li> <li>• Maximum voltage: <math>\leq 30</math> V DC</li> <li>• Input current (typically): 2.5 mA</li> <li>• Sampling period: 1 ms</li> </ul>
11	DI11	Digital input 11	
12	DI12	Digital input 12	
13	DI13	Digital input 13	
14	DI14	Digital input 14	
15	DI15	Digital input 15	
16	DI16	Digital input 16	
17	DQCOM	Reference potential for the digital outputs	The 24 V DC digital outputs DQ comply with the standard IEC/EN 61131-2. <ul style="list-style-type: none"> <li>• Logic type selected by DQCOM wiring</li> <li>• Output voltage: <math>\leq 30</math> V DC</li> <li>• Switching capability: <math>\leq 100</math> mA</li> <li>• Voltage drop at 100 mA load: <math>\leq 3</math> V DC</li> <li>• Response time: 1 ms</li> </ul>
18	DQ11	Digital output 11	

## DANGER

### HAZARD OF ELECTRIC SHOCK, EXPLOSION OR ARC FLASH

- Verify that the temperature sensors in the motor meet the PELV requirements.
- Verify that the motor encoder meets the PELV requirements.
- Verify that any other equipment connected via signal cables meets the PELV requirements.

**Failure to follow these instructions will result in death or serious injury.**

Signal interference can cause unexpected responses of the drive and of other equipment in the vicinity of the drive.

## WARNING

### SIGNAL AND EQUIPMENT INTERFERENCE

- Install the wiring in accordance with the EMC requirements described in this document.
- Verify compliance with the EMC requirements described in this document.
- Verify compliance with all EMC regulations and requirements applicable in the country in which the product is to be operated and with all EMC regulations and requirements applicable at the installation site.

**Failure to follow these instructions can result in death, serious injury, or equipment damage.**



## Option "Relay Output Card"

### Control terminals at the expansion card

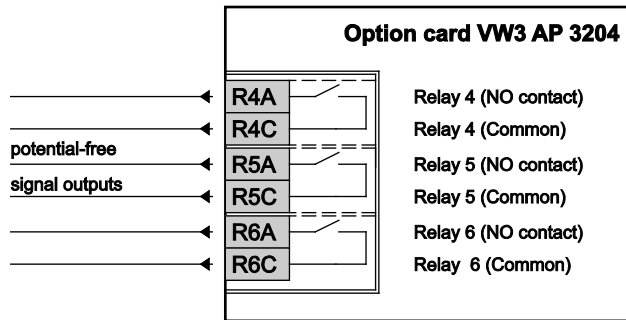

### Specification of the Control Terminals

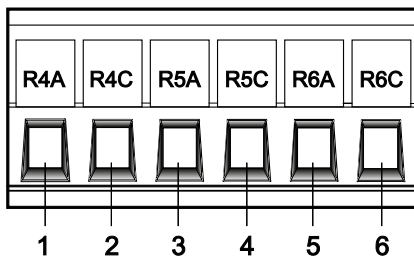

#### Screw terminals

Maximum cable cross section: 1.5 mm<sup>2</sup> (AWG 16)

Maximum tightening torque: 0.5 Nm (4.4 lb.in)

Minimum cable cross section: 0.75 mm<sup>2</sup> (AWG 18)

Strip length: 10 mm

Pin	Terminal	Description	Specification
1	R4A	Relay output 4 (NO contact)	<b>Programmable relay output 4:</b> <ul style="list-style-type: none"> <li>Minimum switching capacity: 5 mA for 24 V DC</li> <li>Maximum switching capability on resistive load (<math>\cos \varphi = 1</math>): 3 A for 250 V AC and 30 V DC</li> <li>Maximum switching capability on inductive load (<math>\cos \varphi = 0.4</math> and <math>L/R = 7</math> ms): 2 A for 250 V AC and 30 V DC</li> <li>Response time: 5 ms <math>\pm</math> 0.5 ms</li> <li>Life cycle: 100,000 switching cycles at max. switching capacity</li> </ul>
2	R4C		
3	R5A	Relay output 5 (NO contact)	<b>Programmable relay output 5:</b> <ul style="list-style-type: none"> <li>Minimum switching capacity: 5 mA for 24 V DC</li> <li>Maximum switching capability on resistive load (<math>\cos \varphi = 1</math>): 3 A for 250 V AC and 30 V DC</li> <li>Maximum switching capability on inductive load (<math>\cos \varphi = 0.4</math> and <math>L/R = 7</math> ms): 2 A for 250 V AC and 30 V DC</li> <li>Response time: 5 ms <math>\pm</math> 0.5 ms</li> <li>Life cycle: 100,000 switching cycles at max. switching capacity</li> </ul>
4	R5C		
5	R6A	Relay output 6 (NO contact)	<b>Programmable relay output 6:</b> <ul style="list-style-type: none"> <li>Minimum switching capacity: 5 mA for 24 V DC</li> <li>Maximum switching capability on resistive load (<math>\cos \varphi = 1</math>): 3 A for 250 V AC and 30 V DC</li> <li>Maximum switching capability on inductive load (<math>\cos \varphi = 0.4</math> and <math>L/R = 7</math> ms): 2 A for 250 V AC and 30 V DC</li> <li>Response time: 5 ms <math>\pm</math> 0.5 ms</li> <li>Life cycle: 100,000 switching cycles at max. switching capacity</li> </ul>
6	R6C		

## Option Terminals

### Control Terminals at the Option Terminals

The option terminals X200 and X205 are built-in at each Altivar Process Drive System as standard. They are designed as pluggable terminals.

#### Spring terminals pluggable

Max. cable cross section: 2.5 mm<sup>2</sup> [AWG 12]  
Min. cable cross section: 0.25 mm<sup>2</sup> [AWG 26]  
Strip length: 10 mm

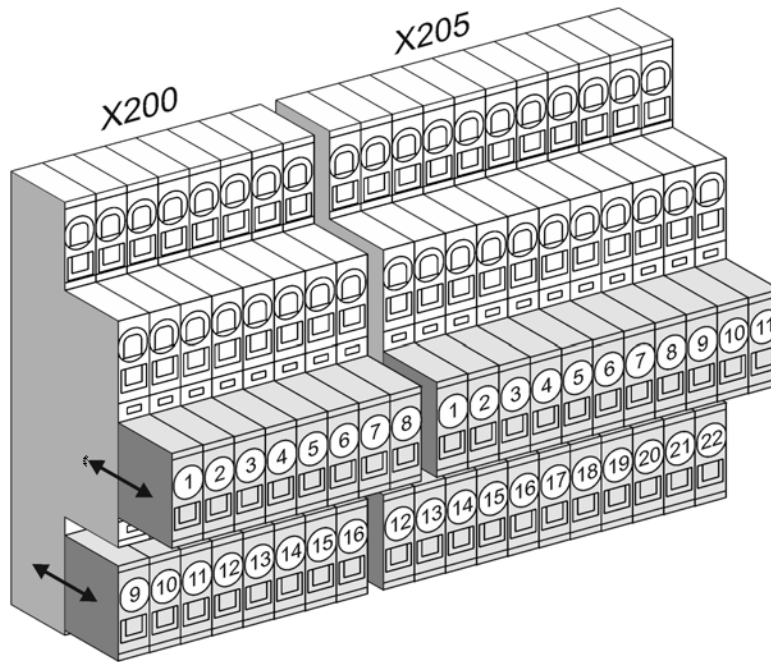

### Specification of the Control Terminals

As shown in the following illustration, there are following connections available for the customer depending on the chosen options.

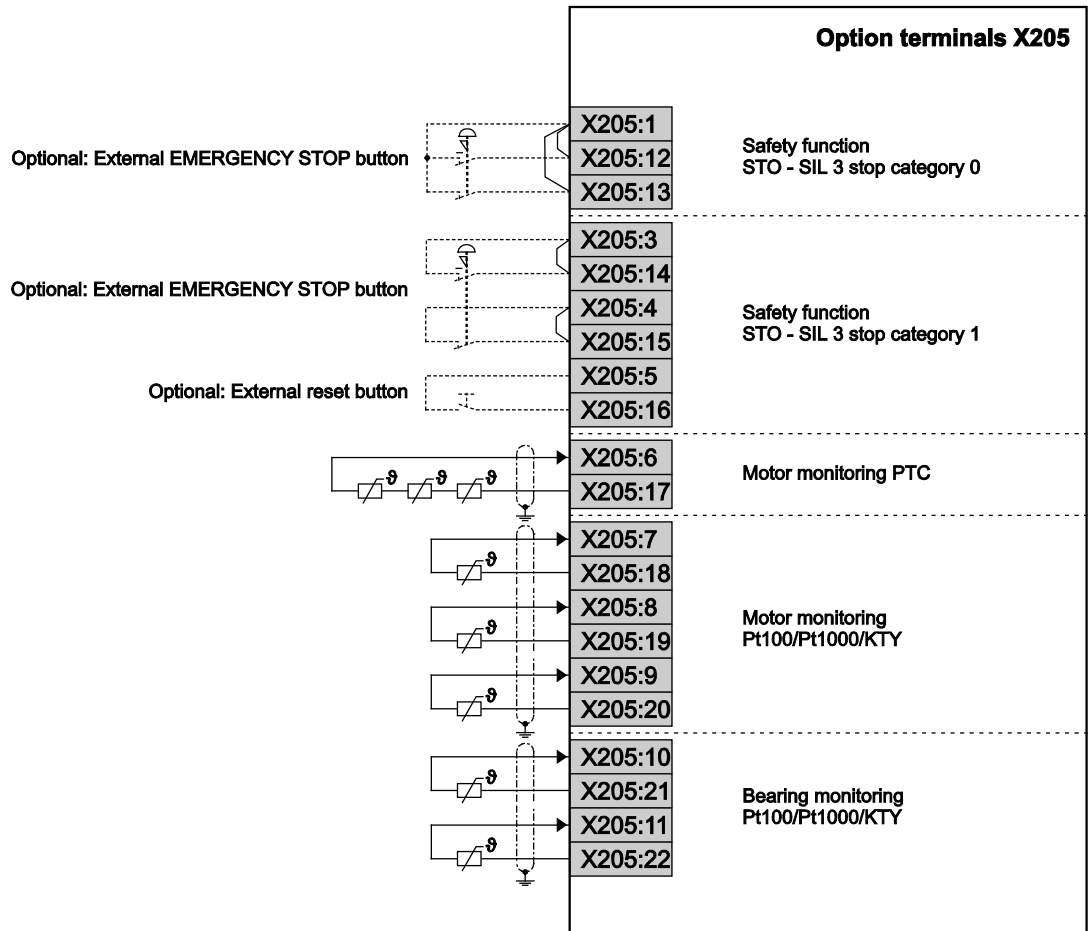
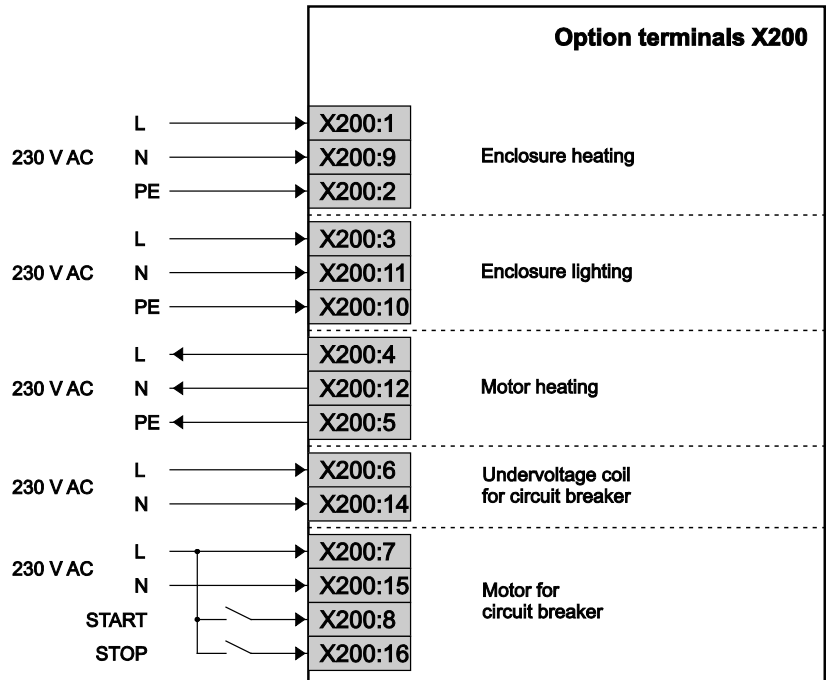



---

# Chapter 5

## Customizations

---

### What Is in This Chapter?

This chapter contains the following topics:

Topic	Page
Enclosure Options	94
Control Options	98
I/O Expansion Cards	99
Communication Cards	100
Functional Safety	102
Display Options	103
Motor Options	104
Mains Supply	106
Monitoring Options	108
Packaging	109

## Enclosure Options

During manufacturing of the Altivar Process Drive Systems already all customizations are considered. In addition, parameter adjustments are carried out and permanently stored as factory setting, if required.

This chapter contains customizations, which we have already predefined as a result of our many years of experience in order to cover the essential requirements of our customers. But in many cases a unique system solution is necessary due to the variety of applications and requirements.

Your Drive Systems Tendering Team is looking forward to your specific request.

### Increased Protection Degree IP54

For operation with rough ambient conditions the enclosure can be designed in protection degree IP54. So when the doors are closed the Altivar Process Drive System is protected against:

- Touching live electrical parts
- Harmful dust accumulation inside
- Penetration of spray water from all directions

Typically, IP54 enclosure units are installed production halls and manufacturing sites, where heavy dirt accumulation is expected.

Our solution contains a clearly specified and tested cooling system with a separate cooling air channel which provides highest reliability.

Via this separated cooling air channel about 90 % of the heat losses are exhausted. The interior of the enclosure is cooled via fans in the enclosure door.

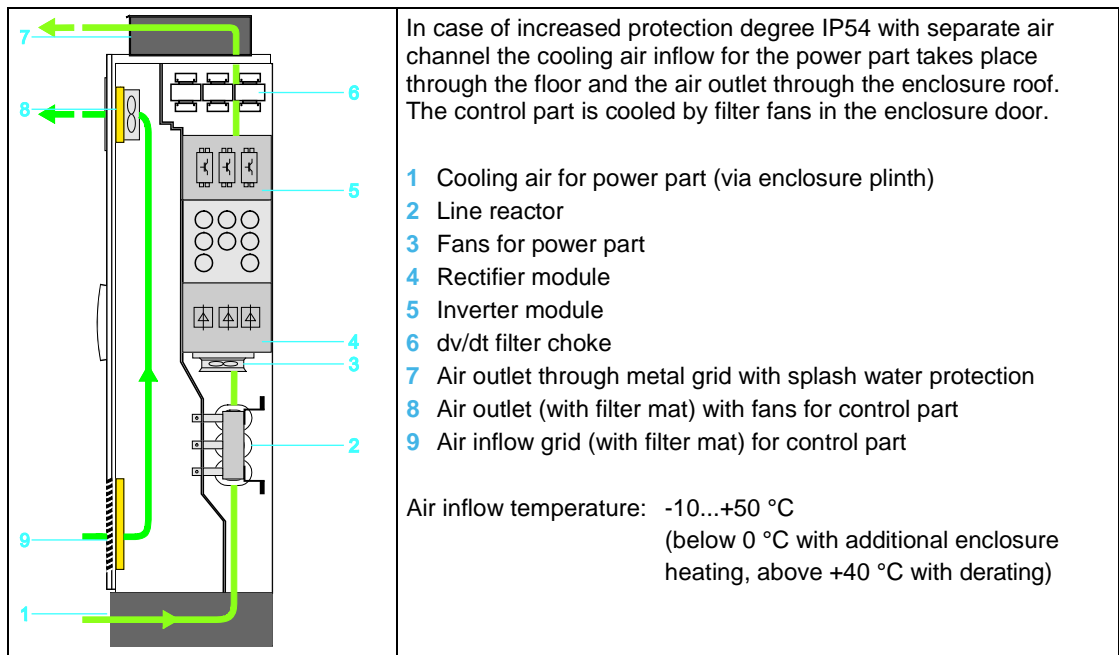

**NOTE:** The additional enclosure plinth increases the enclosure by 200 mm to a total height of 2350 mm.

### Enclosure Plinth for Basic Device

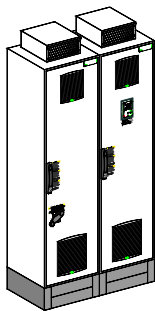

For adapting to the local conditions or for better protection of the enclosure against wet soil, the enclosure can be raised with a plinth (color: RAL 7022) by 200 mm.

So the enclosure height is increased to a total height of 2350 mm.

**NOTE:** At the customization "Increased protection degree IP54" the enclosure is already equipped with an enclosure plinth as standard.

### Connection Enclosure Cable from Top

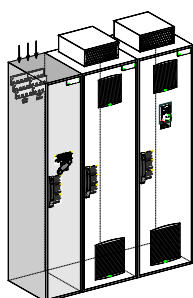

This separate connection enclosure makes it possible to insert and connect the mains cables and motor cables from the top of the enclosure.

The separated connecting enclosure contains all power terminals and the mains disconnection (e.g. main switch), which makes a voltage disconnection of the basic device during maintenance possible.

Furthermore, the connecting enclosure provides enough space for additional customizations.

**NOTE:** The additional connecting enclosure increases the total width of the enclosure.

### Connection Enclosure Cable from Bottom

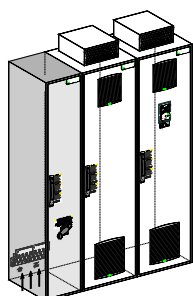

This separate connection enclosure makes it possible to insert and connect the mains cables and motor cables from the bottom of the enclosure.

The separated connecting enclosure contains all power terminals and the mains disconnection (e.g. main switch), which makes a voltage disconnection of the basic device during maintenance possible.

Furthermore, the connecting enclosure provides enough space for additional customizations.

**NOTE:** The additional connecting enclosure increases the total width of the enclosure.

### Enclosure Lighting

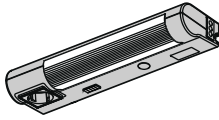

In order to make maintenance easier, the enclosure can be equipped with a lighting, which is switched on when opening the enclosure door.

The lighting is externally supplied and so it is also available at switched off mains supply. Furthermore, a power socket according to VDE standard (230 V / 50 Hz, 2 A) is located on the lighting to operate smaller consumers on-site.

**NOTE:** The additional power supply at terminals X200 has to be provided by the user.

- Rated voltage: 230 V
- Rated frequency: 50/60 Hz
- Rated power: 500 VA

This option requires an additional external 230 V power supply with overvoltage category 1 or 2 (according to IEC/UL 61800-5-1 ) connected to terminals X200.

**⚡ ⚠ DANGER**

**HAZARD OF ELECTRIC SHOCK**  
Verify that the external power supply complies with all national and local electrical code requirements.  
**Failure to follow these instructions will result in death or serious injury.**

### Enclosure Heating

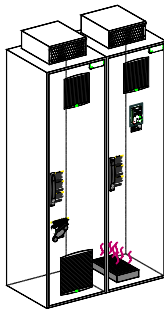

This customization is used to heat the enclosure in order to avoid frost and condensation at an ambient temperature up to -10°C. The enclosure heating is externally supplied, so the enclosure can be also heated when mains supply is switched off.

**NOTE:** The additional power supply at terminals X200 has to be provided by the user.

- Rated voltage: 230 V
- Rated frequency: 50/60 Hz
- Rated power: 400...800 VA

This option requires an additional external 230 V power supply with overvoltage category 1 or 2 (according to IEC/UL 61800-5-1 ) connected to terminals X200.

**⚡ ⚠ DANGER**

**HAZARD OF ELECTRIC SHOCK**  
Verify that the external power supply complies with all national and local electrical code requirements.  
**Failure to follow these instructions will result in death or serious injury.**



## Modified Wiring Colors



This option contains modified wiring colors as well as red, white and blue heat shrink tubes at the power cables.

## Control Options

### Key Switch "local / remote"



The key switch "local / remote" allows to switch between local operation (via the graphical operating panel) or remote control (terminals or bus). The switch can be only operated with a key and so it can be only switched by authorized personnel.

### Ethernet Port on Front Door

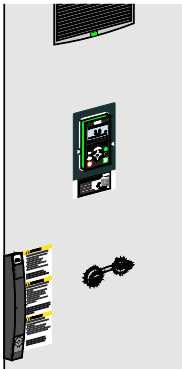

The Ethernet port in the enclosure door allows access to the frequency inverter without opening the enclosure door. The plug can be closed with a dust protection cap.

## I/O Expansion Cards

You will find detailed information in the respective documentation. See listing under chapter "Related Documents", page 9.

### Expansion Card With Additional Inputs / Outputs



Expansion card for additional analog and digital inputs and outputs (6 digital inputs, 2 digital outputs, 2 analog inputs)

You will find further information at chapter "Option "Logic and Analog I/O Card"", page 86.

### Expansion Card With Relay Outputs



Expansion card with three additional relay outputs

You will find further information at chapter "Option "Relay Output Card"", page 89.

## Communication Cards

You will find detailed information in the respective documentation. See listing under chapter "Related Documents", page 9.

### Communication Card Modbus TCP or EtherNet/IP



Dual port option card for control of the inverter via Modbus TCP or EtherNet/IP

### Communication Card CANopen Daisy Chain



Option card for control of the inverter via CANopen Daisy Chain

### Communication Card CANopen SUB-D9



Option card for control of the inverter via CANopen with SUB-D port.

### Communication Card CANopen With Screw Terminals



Option card for control of the inverter via CANopen with screw terminals

### Communication Card DeviceNet



Option card for control of the inverter via DeviceNet

### Communication Card Profibus DP



Option card for control of the inverter via Profibus DP V1

### Communication Card PROFINET



Option card for control of the inverter via PROFINET

## Functional Safety

### Safe Torque Off (STO)

The Altivar Process is equipped with the safety function "Safe Torque Off STO" according to ISO 13849-1, IEC/EN 61508, IEC/EN 60204-1, which helps to prevent any unintended start-up of the motor.

- Inputs STOA and STOB directly at the control terminals of the control block.  
This function fulfills, when correctly wired, the machine standard ISO 13849-1, Performance level PL e, the IEC/EN 61508 Safety integrity level SIL 3 standard for functional safety and the power drive system standard IEC/EN 61800-5-2.
- Customization SIL3, stop category 0 / PL e  
The triggering of the safety function leads to a coast down of the drive and helps to prevent an unintended restart.
- Customization SIL3, stop category 1 / PL e  
The triggering of this function starts a controlled deceleration, shuts down the drive after the set time and helps to prevent an unintended restart.

**NOTE:** You will find further information in the Safety Function Manual ([EAV64334](#)).

### Safe Torque Off STO – SIL 3 Stop Category 0 / Performance Level PL e

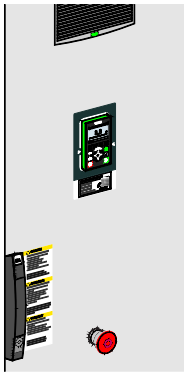

Via an EMERGENCY STOP button in the enclosure door or further implemented, external monitoring equipment, the torque at the motor can be switched off according SIL 3 stop category 0 / performance level PL e.  
The triggering of the safety function leads to a coast down of the drive and helps to prevent an unintended restart.

### Safe Torque Off STO – SIL 3 Stop Category 1 / Performance Level PL e

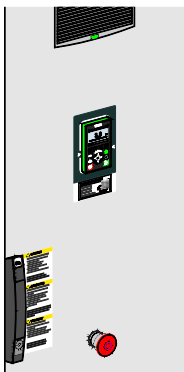

Via an EMERGENCY STOP button in the enclosure door or further implemented, external monitoring equipment, the torque at the motor can be switched off according SIL 3 stop category 1 / performance level PL e.  
The triggering of this function starts a controlled deceleration, shuts down the drive after the set time and helps to prevent an unintended restart.

## Display Options

### Front Display Module (FDM)

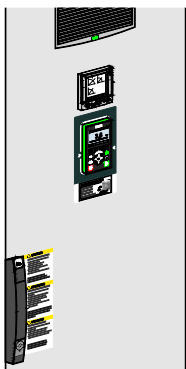

A display element mounted in the enclosure door enables clear indication of real-time values like:

- Indication of mains currents (3x)
- Mains voltages (3x phase voltages, 3x phase-to-phase voltages)
- Mains power

These values can be indicated graphically or digital.

The display element is provided with backlight for increased readability.

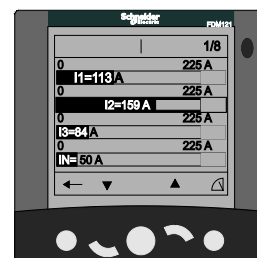

### Indicator Lamps on Front Door

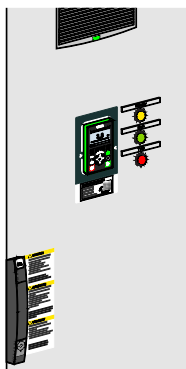

For quick, optical diagnostics of the actual operating state from a greater distance, the enclosure can be equipped with indicator lamps.

The lamps show following operating states:

Operating state	Indicator lamp	Labeling
Ready	Yellow	READY
Operation	Green	RUN
Detected fault	Red	TRIP

## Motor Options

### Motor Monitoring PTC

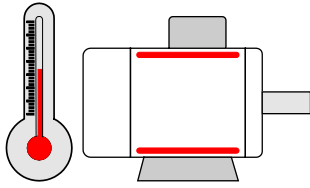

If the motor is equipped with integrated thermistor sensors to help to protect against thermal overload, they can be directly connected to a thermistor relay inside the Altivar Process Drive System.

If the frequency inverter detects an overtemperature at the motor, the drive stops the motor and generates an error message at the display. This operating state is also forwarded to the status relays and to the fieldbus.

**NOTE:** When protective separation of the thermistor sensors in the motor cannot be guaranteed or in case of long motor cables, this option is highly recommended.

### Motor Monitoring PTC with ATEX Certificate

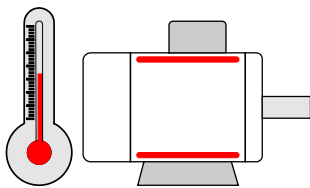

The motor monitoring PTC with ATEX certificate is used to monitor the thermistor sensors of motors which are installed in hazardous area (explosive atmosphere).

If the frequency inverter detects the overtemperature at the motor, the drive stops the motor and generates an error message at the display. This operating state is also forwarded to the status relays and to the fieldbus. The monitoring relay additionally triggers a safe shut-down of the drive.

This equipment has been designed to operate outside of any hazardous location. Only install this equipment in zones known to be free of hazardous atmosphere.

<b>⚠ DANGER</b>
<b>POTENTIAL FOR EXPLOSION</b>
Install and use this equipment in non-hazardous locations only.
<b>Failure to follow these instructions will result in death or serious injury.</b>

### Motor monitoring Pt100/Pt1000/KTY

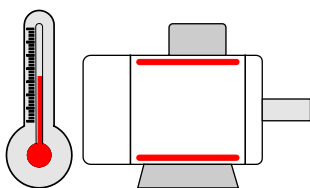

If the motor is equipped with integrated temperature sensors (Pt100, Pt1000, KTY 83/84) in the winding to help to protect against thermal overload, they can be directly connected to the relay inside the Altivar Process Drive System.

If the set temperature at the motor is exceeded, a warning message is generated. When the temperature is further rising over a set value, the drive is stopped and an error message is generated. The operating states are also forwarded to the status relays and to the fieldbus.

**NOTE:** When protective separation of the thermistor sensors in the motor cannot be guaranteed or in case of long motor cables, this option is highly recommended.



## Bearing Monitoring Pt100/Pt1000/KTY

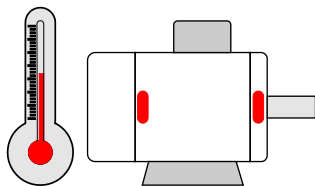

If the motor is equipped with integrated temperature sensors (Pt100, Pt1000, KTY 83/84) in the bearings to help to protect against thermal overload, they can be directly connected to the relay inside the Altivar Process Drive System.

If the set temperature at the motor is exceeded, a warning message is generated. When the temperature is further rising over a set value, the drive is stopped and an error message is generated. The operating states are also forwarded to the status relays and to the fieldbus.

**NOTE:** When protective separation of the thermistor sensors in the motor cannot be guaranteed or in case of long motor cables, this option is highly recommended.

## dv/dt Filter Choke 150 m

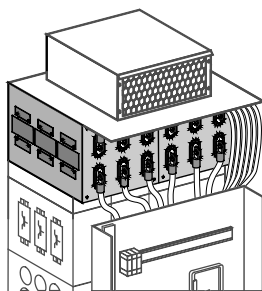

The use of the customization dv/dt filter choke 150 m has significant advantages concerning the operation of the drive:

- Decrease of the dv/dt and peak voltage load of the motor
- Prevention of common mode bearing currents in the motor – especially important at high power
- Great reduction of the influences to other cables – important if the separate laying of motor cables is not possible
- In case of long motor cables up to 150 m shielded or up to 250 m unshielded
- dv/dt filter choke 150 m can be installed without enlarged enclosure width.

**NOTE:** You will find further information about long motor cables under chapter "Length of Motor Cables", page 70.

## dv/dt Filter Choke 300 m

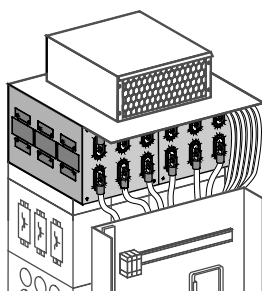

The use of the customization dv/dt filter choke 300 m has significant advantages concerning the operation of the drive:

- Decrease of the dv/dt and peak voltage load of the motor
- Prevention of common mode bearing currents in the motor – especially important at high power
- Great reduction of the influences to other cables – important if the separate laying of motor cables is not ensured
- In case of long motor cables up to 300 m shielded or up to 500 m unshielded
- dv/dt filter choke 300 m can be installed without enlarged enclosure width.

**NOTE:** You will find further information about long motor cables under chapter "Length of Motor Cables", page 70.

## Motor Heating

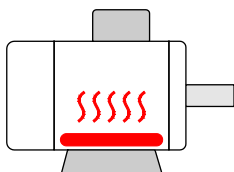

The motor standstill heating is used to avoid condensate and frost damages at standstill of the motors in cold environment. It is activated when the motor is shut down.

## Mains Supply

### Circuit Breaker

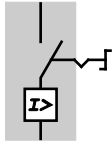

The circuit breaker is used for mains disconnection instead of the main switch. It is operated by a handle in the enclosure door.

The circuit breaker can be optionally equipped with an undervoltage coil and motor.

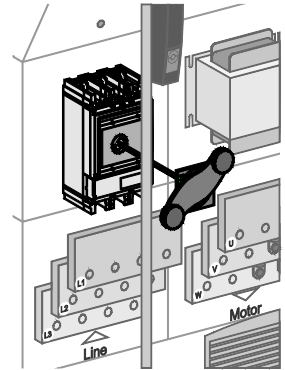

### Undervoltage Coil for Circuit Breaker 230 V

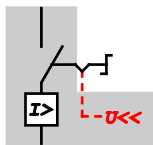

When there is no voltage at the undervoltage coil, the circuit breaker switches off. The undervoltage coil is built into the circuit breaker and is wired to the option terminals.

#### Specification of the control terminals

X200: 6/14      External control voltage  
220...240 V AC 50/60 Hz

- NOTE:**
- Only when control voltage is applied, the circuit breaker can be switched on manually.
  - You will find further information about the topic wiring under chapter "Option Terminals", page 90.

## Motor for Circuit Breaker 230 V

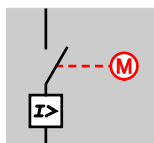

Remote control of the circuit breaker via control commands is possible by means of this motor drive. The motor drive is built into the circuit breaker and is wired to the option terminals.

### Specification of the control terminals

X200: 7/15	External control voltage 220...240 V AC 50/60 Hz
X200: 8	Start request
X200: 16	Stop request

### Specification of the motor drive:

External control circuit voltage:

- 230 V AC  $\pm$  5% 50/60 Hz

Reaction time:

- < 80 ms when closing
- < 600 ms when opening

Power input:

- $\leq$  500 VA when closing
- $\leq$  500 VA when opening

- NOTE:**
- At this customization no handle for the circuit breaker is possible.
  - You will find further information about the topic wiring under chapter "Option Terminals", page 90.
  - You will find further information about the topic switching rate under chapter "Switching Rate", page 25.

## Monitoring Options

### Remote Monitoring

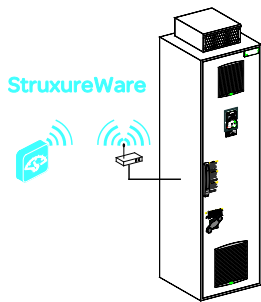

With remote monitoring the Altivar Process Drive System can be monitored via Ethernet or Modbus using a PC, tablet or smart phone.

The delivered gateway records the data of the Drive System in regular intervals. The collected data are transmitted using an integrated GPRS modem via the mobile phone network to the Schneider Electric StruxureWare Energy Operation network.

You can easily access the provided date of your Altivar Process System using PC, tablet or smart phone in order to analyze them and to be up-to-date:

- Notification per email or SMS when reaching warning or error states
- Preset reminders per email for maintenance purpose, inspection,...
- Cyclical sending of status reports

Via the predefined data model the following values are monitored 24/7 and logged:

Registered data	
<ul style="list-style-type: none"> <li>• Mains voltage</li> <li>• Mains frequency</li> <li>• DC link voltage</li> <li>• Input / output voltage</li> <li>• Motor current and voltage</li> <li>• Motor speed</li> <li>• Motor torque</li> </ul>	<ul style="list-style-type: none"> <li>• Energy consumption</li> <li>• Energy saving by frequency inverter operation</li> <li>• Saving of CO<sub>2</sub> emission</li> <li>• Thermal state of motor and Drive System</li> <li>• Operating state of Drive System</li> <li>• Event memory with detailed information</li> <li>• Application data (input / output pressure, flow,...)</li> </ul>

The module contains additional inputs in order to record further measures:

- 2 temperature sensors (Pt100 or Pt1000)
- 6 digital inputs
- 2 analog inputs

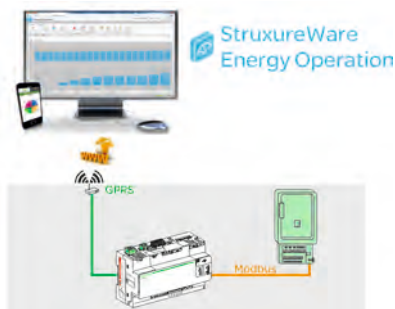

**NOTE:** For this option a service contract is necessary which will imply additional costs.

## Packaging

### Safety Labels in Local Language

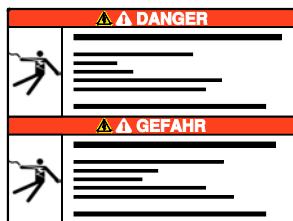

All Altivar Process Drive Systems are delivered with safety labels in English and French.

Optionally the devices can be also ordered with labels in the local language.

### Seaworthy Packaging

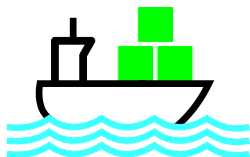

This option contains a seaworthy packaging for transport by ship. The packaging complies with the HPE packaging guidelines (federal association for wooden packages, pallets and export packaging in Germany).





