

Altivar Machine ATV320

Variable Speed Drives
For Asynchronous and Synchronous Motors

Modbus TCP - EtherNet/IP Manual - VW3A3616

02/2017



The information provided in this documentation contains general descriptions and/or technical characteristics of the performance of the products contained herein. This documentation is not intended as a substitute for and is not to be used for determining suitability or reliability of these products for specific user applications. It is the duty of any such user or integrator to perform the appropriate and complete risk analysis, evaluation and testing of the products with respect to the relevant specific application or use thereof. Neither Schneider Electric nor any of its affiliates or subsidiaries shall be responsible or liable for misuse of the information contained herein. If you have any suggestions for improvements or amendments or have found errors in this publication, please notify us.

No part of this document may be reproduced in any form or by any means, electronic or mechanical, including photocopying, without express written permission of Schneider Electric. All pertinent state, regional, and local safety regulations must be observed when installing and using this product. For reasons of safety and to help ensure compliance with documented system data, only the manufacturer should perform repairs to components.

When devices are used for applications with technical safety requirements, the relevant instructions must be followed.

Failure to use Schneider Electric software or approved software with our hardware products may result in injury, harm, or improper operating results.

Failure to observe this information can result in injury or equipment damage.

© 2017 Schneider Electric. All rights reserved.

Table of Contents



	Safety Information	6
	About the Book	9
Chapter 1	Presentation	12
	Overview	13
	Transparent Ready	13
	Modbus TCP - EtherNet/IP Communication Card Features Overview	14
	Modbus TCP	14
	EtherNet/IP	15
	TCP/IP and Ethernet Features	15
	Webserver	15
	Notation	16
Chapter 2	Hardware Setup	17
	Hardware Presentation	18
	Firmware and EDS Version Compatibility	18
	Installation of the module	18
	Wiring	20
	Installation Topology	21
	LED's Indicators	22
Chapter 3	Configuration and Parameters	24
	Network Settings	25
	Modbus TCP Settings	27
	FDR Settings	30
	EtherNet/IP Settings	31
	Monitoring of Communication Channels	32
Chapter 4	Configuration of the Drive Commands Settings	34
	Configuration of the Drive for Operation in I/O Profile	35
	Configuration of the Drive for Operation With CiA402 Profile in Combined Mode	36
	Configuration of the Drive for Operation With CiA402 Profile in Separate Mode	36
Chapter 5	Network Layer Supported Functions/Protocols	37
	ARP, ICMP and IP Protocol	37
Chapter 6	Transport Layer Protocols	39
	TCP and UDP Protocol	39
Chapter 7	Modbus TCP Features	41
	Modbus TCP Frames	42
	ATV320 and VW3A3616: Modbus Servers	42
	Supported Modbus Functions	43
	Application Profile with Modbus TCP	48
	Configuring Communication Detected Fault Management	49
	Configuring Monitor Parameters	51
Chapter 8	Controlling an ATV320 From Modbus TCP (M340)	52
	Description of the Configuration	53
	Configuration of the Ethernet Module (NOE 100 or NOE 110)	55
	Monitor and Control the Exchanges	58

	Modbus Messaging	59
Chapter 9	EtherNet/IP Features	60
	VW3A3616 and EtherNet/IP Overview	61
	Cyclical Exchanges (Implicit Exchanges)	62
	Messaging (Explicit Exchanges)	66
	Detected Fault Management	67
Chapter 10	ATV320 Configuration in ETC100	68
	Procedure	69
	Explicit Messaging	74
Chapter 11	Profiles	76
	Definition of a Profile	77
	Functional Profiles Supported by the Altivar 320	78
Chapter 12	CiA®402 - IEC61800-7 Functional Profile	79
	Functional Description	80
	CiA402 State Chart	81
	Description of States	82
	Summary	83
	Control Word (CMD)	84
	Stop Commands	85
	Assigning Control Word Bits	85
	Status Word (EtA)	86
	Starting Sequence	87
	Sequence for a Drive Powered by the Power Section Line Supply	88
	Sequence for a Drive With Separate Control Section	90
	Sequence for a Drive With Line Contactor Control	93
Chapter 13	CIP Objects Overview	95
	Objects in the AC/DC Drive Device	96
	Object 28hex (Motor Data)	96
	Object 29hex (Control Supervisor)	97
	Object 2Ahex (AC/DC Drive)	98
Chapter 14	Transparent Ready Features	99
	Presentation	100
	Startup Detailed Behavior	101
	FDR Operation Behavior	102
	FDR Settings	103
	Local Configuration	104
	Downloaded Configuration	105
Chapter 15	Embedded Webserver	107
	Overview	108
	Connexion to the Webserver	108
	Pages Description	109
	FTP Server	117
Chapter 16	Integration in the EtherNet/IP Network	118
	Installing the EDS File	119
	Configuration of the EtherNet/IP Module in the Rockwell PLC	121
	Configuring the Implicit Exchanges	122
	Configuration of the Communication Scanner	124
	Configuration of the Communication Period	125
	Explicit Messaging	126
	Assembly Selection	128
Chapter 17	Software Setup with SoMachine (M251)	129
	Introduction	130

	Drive Configuration	131
	Ethernet Master Configuration	132
Chapter 18	CIP Objects	137
	Supported Object Classes	138
	Identity Object (F1h)	138
	Message Router Object (F2h)	141
	TCP/IP Interface Object (F5h)	141
	Ethernet Link Object (F6h)	144
	Assembly Object (04 hex)	145
	Connection Manager Object (06h)	147
	Motor Data Object (28h)	149
	Control Supervisor Object (29h)	150
	AC/DC Drive Object (2Ah)	151
	Application Object (70h to C7h) / Explicit Messaging	154

Safety Information

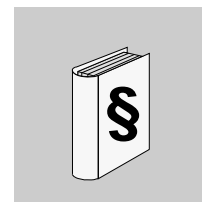

Important Information

NOTICE

Read these instructions carefully, and look at the equipment to become familiar with the device before trying to install, operate, or maintain it. The following special messages may appear throughout this documentation or on the equipment to warn of potential hazards or to call attention to information that clarifies or simplifies a procedure.



The addition of this symbol to a Danger or Warning safety label indicates that an electrical hazard exists, which will result in personal injury if the instructions are not followed.



This is the safety alert symbol. It is used to alert you to potential personal injury hazards. Obey all safety messages that follow this symbol to avoid possible injury or death.

▲ DANGER

DANGER indicates a hazardous situation, which, if not avoided, **will result** in death or serious injury.

▲ WARNING

WARNING indicates a hazardous situation, which, if not avoided, **could result** in death or serious injury.

▲ CAUTION

CAUTION indicates a hazardous situation, which, if not avoided, **could result** in minor or moderate injury.

NOTICE

NOTICE is used to address practices not related to physical injury.

PLEASE NOTE

Electrical equipment should be installed, operated, serviced, and maintained only by qualified personnel. No responsibility is assumed by Schneider Electric for any consequences arising out of the use of this material.

A qualified person is one who has skills and knowledge related to the construction and operation of electrical equipment and its installation, and has received safety training to recognize and avoid the hazards involved.

Qualification Of Personnel

Only appropriately trained persons who are familiar with and understand the contents of this manual and all other pertinent product documentation are authorized to work on and with this product. In addition, these persons must have received safety training to recognize and avoid hazards involved. These persons must have sufficient technical training, knowledge and experience and be able to foresee and detect potential hazards that may be caused by using the product, by changing the settings and by the mechanical, electrical and electronic equipment of the entire system in which the product is used. All persons working on and with the product must be fully familiar with all applicable standards, directives, and accident prevention regulations when performing such work.

Product Related Information

Read and understand these instructions before performing any procedure with this drive.

DANGER

HAZARD OF ELECTRIC SHOCK, EXPLOSION OR ARC FLASH

- Only appropriately trained persons who are familiar with and understand the contents of this manual and all other pertinent product documentation and who have received safety training to recognize and avoid hazards involved are authorized to work on and with this drive system. Installation, adjustment, repair and maintenance must be performed by qualified personnel.
- The system integrator is responsible for compliance with all local and national electrical code requirements as well as all other applicable regulations with respect to grounding of all equipment.
- Many components of the product, including the printed circuit boards, operate with mains voltage. Do not touch.
- Only use properly rated, electrically insulated tools and measuring equipment.
- Do not touch unshielded components or terminals with voltage present.
- Motors can generate voltage when the shaft is rotated. Prior to performing any type of work on the drive system, block the motor shaft to prevent rotation.
- AC voltage can couple voltage to unused conductors in the motor cable. Insulate both ends of unused conductors of the motor cable.
- Do not short across the DC bus terminals or the DC bus capacitors or the braking resistor terminals.
- Before performing work on the drive system:
 - Disconnect all power, including external control power that may be present.
 - Place a **Do Not Turn On** label on all power switches related to the drive system.
 - Lock all power switches in the open position.
 - Wait 15 minutes to allow the DC bus capacitors to discharge.
 - Follow the instructions given in the chapter "Verifying the Absence of Voltage" in the installation-manual of the product.
- Before applying voltage to the drive system:
 - Verify that the work has been completed and that the entire installation cannot cause hazards.
 - If the mains input terminals and the motor output terminals have been grounded and short-circuited, remove the ground and the short circuits on the mains input terminals and the motor output terminals.
 - Verify proper grounding of all equipment.
 - Verify that all protective equipment such as covers, doors, grids is installed and/or closed.

Failure to follow these instructions will result in death or serious injury.

Drive systems may perform unexpected movements because of incorrect wiring, incorrect settings, incorrect data or other errors.

WARNING

UNEXPECTED EQUIPMENT OPERATION

- Carefully install the wiring in accordance with the EMC requirements.
- Do not operate the product with unknown or unsuitable settings or data.
- Perform a comprehensive commissioning test.

Failure to follow these instructions can result in death, serious injury, or equipment damage.

Damaged products or accessories may cause electric shock or unanticipated equipment operation.

DANGER

ELECTRIC SHOCK OR UNANTICIPATED EQUIPMENT OPERATION

Do not use damaged products or accessories.

Failure to follow these instructions will result in death or serious injury.

Contact your local Schneider Electric sales office if you detect any damage whatsoever.

WARNING

LOSS OF CONTROL

- The designer of any control scheme must consider the potential failure modes of control paths and, for critical control functions, provide a means to achieve a safe state during and after a path failure. Examples of critical control functions are emergency stop, overtravel stop, power outage and restart.
- Separate or redundant control paths must be provided for critical control functions.
- System control paths may include communication links. Consideration must be given to the implications of unanticipated transmission delays or failures of the link.
- Observe all accident prevention regulations and local safety guidelines (1).
- Each implementation of the product must be individually and thoroughly tested for proper operation before being placed into service.

Failure to follow these instructions can result in death, serious injury, or equipment damage.

(1) For USA: Additional information, refer to NEMA ICS 1.1 (latest edition), Safety Guidelines for the Application, Installation, and Maintenance of Solid State Control and to NEMA ICS 7.1 (latest edition), Safety Standards for Construction and Guide for Selection, Installation and Operation of Adjustable-Speed Drive Systems.

NOTICE

DESTRUCTION DUE TO INCORRECT MAINS VOLTAGE

Before switching on and configuring the product, verify that it is approved for the mains voltage

Failure to follow these instructions can result in equipment damage.

The product is not approved for use in hazardous areas (explosive atmospheres).

WARNING

EXPLOSION HAZARD

Only use this device outside of hazardous areas (explosive atmospheres).

Failure to follow these instructions can result in death, serious injury, or equipment damage.

Machines, controllers, and related equipment are usually integrated into networks. Unauthorized persons and malware may gain access to the machine as well as to other devices on the network/fieldbus of the machine and connected networks via insufficiently secure access to software and networks.

WARNING

UNAUTHORIZED ACCESS TO THE MACHINE VIA SOFTWARE AND NETWORKS

- In your hazard and risk analysis, consider all hazards that result from access to and operation on the network/fieldbus and develop an appropriate cyber security concept.
- Verify that the hardware infrastructure and the software infrastructure into which the machine is integrated as well as all organizational measures and rules covering access to this infrastructure consider the results of the hazard and risk analysis and are implemented according to best practices and standards covering IT security and cyber security (such as: ISO/IEC 27000 series, Common Criteria for Information Technology Security Evaluation, ISO/IEC 15408, IEC 62351, ISA/IEC 62443, NIST Cybersecurity Framework, Information Security Forum - Standard of Good Practice for Information Security).
- Verify the effectiveness of your IT security and cyber security systems using appropriate, proven methods.

Failure to follow these instructions can result in death, serious injury, or equipment damage.

About the Book

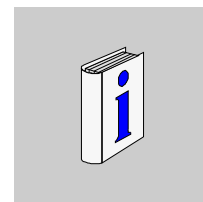

At a Glance

Document Scope

The purpose of this document is to:

- show you how to install the Ethernet fieldbus on your drive,
- show you how to configure the drive to use Ethernet for monitoring and control,
- provide examples of setup using Unity.

NOTE: Read and understand this document and all related documents (see below) before installing, operating, or maintaining your drive.

Validity Note

This documentation is valid for the Altivar Machine drives.

The technical characteristics of the devices described in this document also appear online. To access this information online:

Step	Action
1	Go to the Schneider Electric home page www.schneider-electric.com .
2	In the Search box type the reference of a product or the name of a product range. <ul style="list-style-type: none"> • Do not include blank spaces in the reference or product range. • To get information on grouping similar modules, use asterisks (*).
3	If you entered a reference, go to the Product Datasheets search results and click on the reference that interests you. If you entered the name of a product range, go to the Product Ranges search results and click on the product range that interests you.
4	If more than one reference appears in the Products search results, click on the reference that interests you.
5	Depending on the size of your screen, you may need to scroll down to see the data sheet.
6	To save or print a data sheet as a .pdf file, click Download XXX product datasheet .

The characteristics that are presented in this manual should be the same as those characteristics that appear online. In line with our policy of constant improvement, we may revise content over time to improve clarity and accuracy. If you see a difference between the manual and online information, use the online information as your reference.

Related Documents

Use your tablet or your PC to quickly access detailed and comprehensive information on all our products on www.schneider-electric.com

The internet site provides the information you need for products and solutions

- The whole catalog for detailed characteristics and selection guides
- The CAD files to help design your installation, available in over 20 different file formats
- All software and firmware to maintain your installation up to date
- A large quantity of White Papers, Environment documents, Application solutions, Specifications... to gain a better understanding of our electrical systems and equipment or automation

And finally all the User Guides related to your drive, listed below: You can download the latest versions of these technical publications and other technical information from our website at www.schneider-electric.com.

Title of documentation	Reference Number
ATV320 Getting Started	NVE21763 (English) NVE21771 (French) NVE21772 (German) NVE21773 (Spanish) NVE21774 (Italian) NVE21776 (Chinese)
ATV320 Getting Started Annex (SCCR)	NVE21777 (English)
ATV320 Installation manual	NVE41289 (English) NVE41290 (French) NVE41291 (German) NVE41292 (Spanish) NVE41293 (Italian) NVE41294 (Chinese)
ATV320 Programming manual	NVE41295 (English) NVE41296 (French) NVE41297 (German) NVE41298 (Spanish) NVE41299 (Italian) NVE41300 (Chinese)
ATVATV320 Modbus Serial Link manual	NVE41308 (English)
ATV320 PROFIBUS DP manual (VW3A3607)	NVE41310 (English)
ATV320 Ethernet IP/Modbus TCP manual (VW3A3616)	NVE41313 (English)
ATV320 DeviceNet manual (VW3A3609)	NVE41314 (English)
ATV320 CANopen manual (VW3A3608, 618, 628)	NVE41309 (English)
ATV320 POWERLINK manual (VW3A3619)	NVE41312 (English)
ATV320 EtherCAT manual (VW3A3601)	NVE41315 (English)
ATV320 Communication Parameters	NVE41316 (English)
ATV320 PROFINET manual	NVE41311 (English)
ATV320 Safety Functions manual	NVE50467 (English) NVE50468 (French) NVE50469 (German) NVE50470 (Spanish) NVE50472 (Italian) NVE50473 (Chinese)

You can download these technical publications and other technical information from our website at <http://download.schneider-electric.com>

Terminology

The technical terms, terminology, and the corresponding descriptions in this manual normally use the terms or definitions in the relevant standards.

In the area of drive systems this includes, but is not limited to, terms such as **error**, **error message**, **failure**, **fault**, **fault reset**, **protection**, **safe state**, **safety function**, **warning**, **warning message**, and so on.

Among others, these standards include:

- IEC 61800 series: Adjustable speed electrical power drive systems
- IEC 61508 Ed.2 series: Functional safety of electrical/electronic/programmable electronic safety-related
- EN 954-1 Safety of machinery - Safety related parts of control systems

- EN ISO 13849-1 & 2 Safety of machinery - Safety related parts of control systems.
- IEC 61158 series: Industrial communication networks - Fieldbus specifications
- IEC 61784 series: Industrial communication networks - Profiles
- IEC 60204-1: Safety of machinery - Electrical equipment of machines – Part 1: General requirements

In addition, the term **zone of operation** is used in conjunction with the description of specific hazards, and is defined as it is for a **hazard zone** or **danger zone** in the EC Machinery Directive (2006/42/EC) and in ISO 12100-1.

Presentation

1

What's in this Chapter?

This chapter contains the following topics:

Topic	Page
Overview	13
Transparent Ready	13
Modbus TCP - EtherNet/IP Communication Card Features Overview	14
Modbus TCP	14
EtherNet/IP	15
TCP/IP and Ethernet Features	15
Webserver	15
Notation	16

Overview

The VW3A3616 is a dual port Ethernet communication module that can be used in the following two industrial communication protocols: Modbus TCP and EtherNet/IP. In addition of the communication services provided by each protocol, the VW3A3616 provides a set of common services at the Ethernet and TCP/IP level. The VW3A3616 offers also an embedded web server (English) which offers comfortable monitoring and commissioning functions directly from a standard web browser.

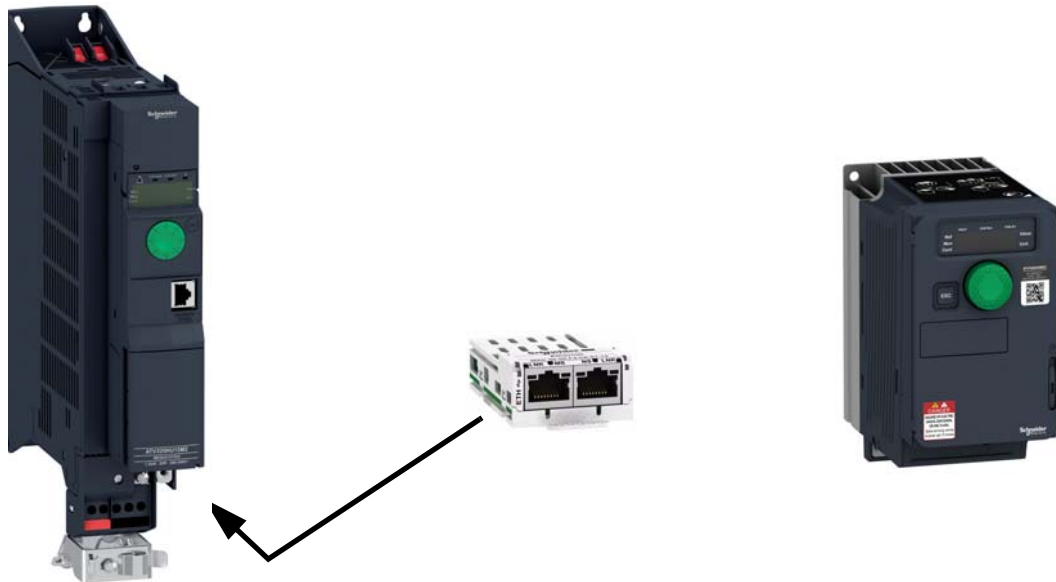

Basic Overview According to the Simplified TCP/IP Model

Application	Modbus TCP - EtherNet/IP
Transport	TCP / UDP
Network	IP
Link	Ethernet

Transparent Ready

Introduced by Schneider Electric, the Transparent Ready concept enables transparent communication between control system devices, production and management. Network technologies and the associated new services are used to share and distribute data between sensors, PLCs, workstations and third-party devices in an increasingly efficient manner. Web servers embedded in the network components and control system devices can be used to:

- Access configuration data transparently
- Perform remote diagnostics
- Incorporate simple human/machine interface functions

This concept is based on the Ethernet TCP/IP industrial standard which proposes a single network that meets most communication requirements from sensors/actuators to production management systems. Where a variety of communication systems is usually required, Transparent Ready standard technologies can result in significant cost savings in the areas of definition, installation, maintenance or training.

Transparent Ready is based on:

- Ethernet TCP/IP-based services meeting control system requirements in terms of functions, performance and quality of services
- Products including several ranges of PLC, distributed I/O, industrial terminals, variable speed drives, gateways and an increasing number of partner products
- The ConneXium range of cabling accessories: hubs, switches, cables adapted to the environment and to the requirements of industrial conditions.

Modbus TCP - EtherNet/IP Communication Card Features Overview

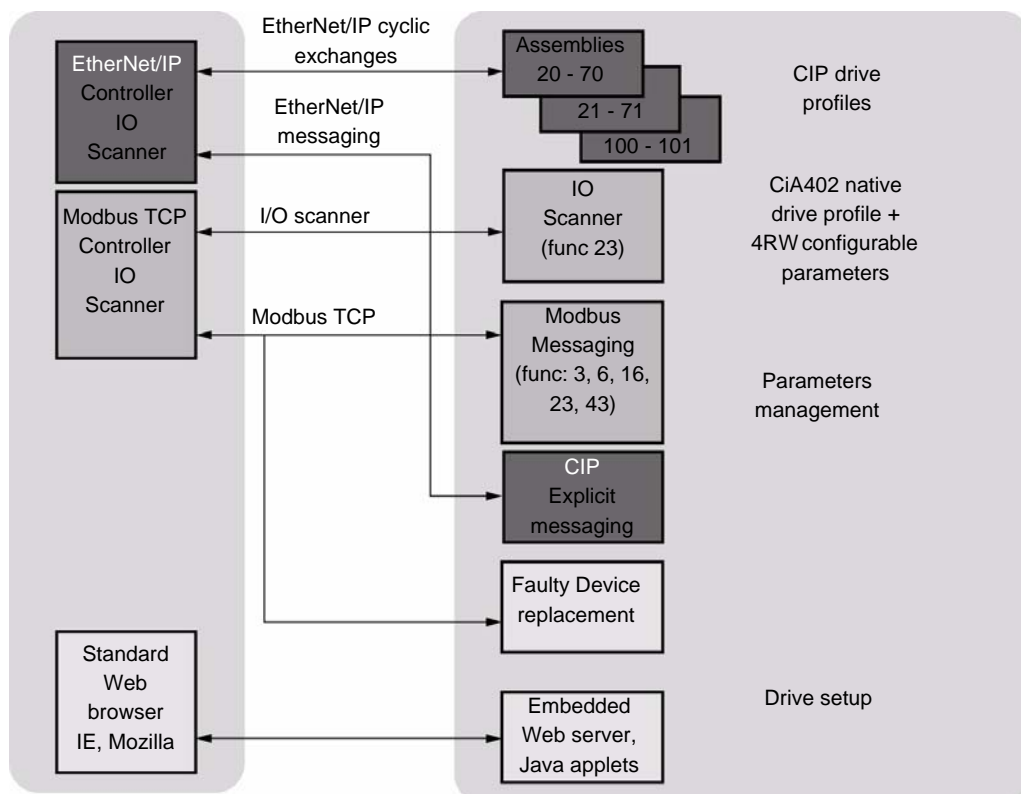

Modbus TCP

The Modbus application layer is standard. Thousands of manufacturers are already implementing this protocol. Many have already developed a Modbus TCP/IP connection and numerous products are currently available. With the simplicity of its protocol and the fast Ethernet throughput data rate of 100 Mbps, Modbus TCP/IP achieves excellent performance.

EtherNet/IP

EtherNet/IP is a fieldbus based on TCP and UDP. EtherNet/IP extends Ethernet by an advanced industrial protocol (CIP, Common Industrial Protocol) as an application layer for automation applications in this way, Ethernet is excellently suited for industrial control. Products from different manufacturers can be networked without the need for special interface adaptation.

TCP/IP and Ethernet Features

The product supports the following functions via:

- Automatic IP address assignment via BOOTP or DHCP
- Automatic configuration data via FDR (only in Modbus TCP)
- Commissioning via commissioning software SoMove
- Diagnostics and configuration via integrated web server

Webserver

The standard Web server (English only) provides access to the following pages:

- Altivar Viewer
- Data Viewer
- Ethernet
- Security
- Etc...

Notation

Drive Terminal Displays

The graphic display terminal (to be ordered separately - reference VW3A1101) menus are shown in square brackets.

Example: **[Communication]**

The integrated 7-segment display terminal menus are shown in round brackets.

Example: (L F F -)

Parameter names are displayed on the graphic display terminal in square brackets.

Example: **[Fallback speed]**

Parameter codes are displayed on the integrated 7-segment display terminal in round brackets.

Example: (L F F)

Formats

In this manual, hexadecimal values are written as follows: 16#

Binary values are written as follows: 2#

Abbreviations

Req. = Required

Opt. = Optional

Hardware Setup



2

What's in this Chapter?

This chapter contains the following topics:

Topic	Page
Hardware Presentation	18
Firmware and EDS Version Compatibility	18
Installation of the module	18
Wiring	20
Installation Topology	21
LED's Indicators	22

Hardware Presentation

The following figure presents the Modbus TCP - EtherNet/IP module:



Firmware and EDS Version Compatibility

Only VW3A3616 option cards, with minimum 1.14IE01 firmware version, are compliant with ATV320.

NOTE: Check the firmware version, on the packaging label (on the right part of the label).

The associated EDS is the following SE_ET_ATV320_0114E.eds. This file is available on www.schneider-electric.com.

Installation of the module

Before Starting

Verify that the catalog number printed on the label corresponds to the purchase order.

Remove the fieldbus module from its packaging and check that it has not been damaged in transit.

⚠️ ⚠️ DANGER

ELECTRIC SHOCK OR UNANTICIPATED EQUIPMENT OPERATION

Do not use damaged products or accessories.

Failure to follow these instructions will result in death or serious injury.

Insertion of the fieldbus module

The table provides the procedure for insertion of the Modbus TCP - EtherNet/IP module in the drive:

Step	Action
1	Ensure that the power is off.
2	Locate the fieldbus module slott on the bottom of the control part.
3	Add the corresponding sticker on the LED front panel of the drive.
4	Insert the module.
5	Check that the module is correctly inserted and locked mechanically in the drive.

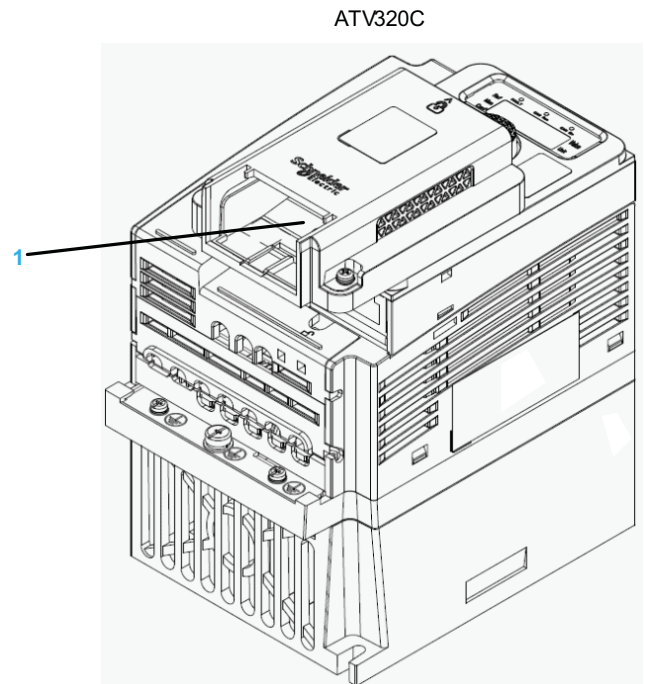
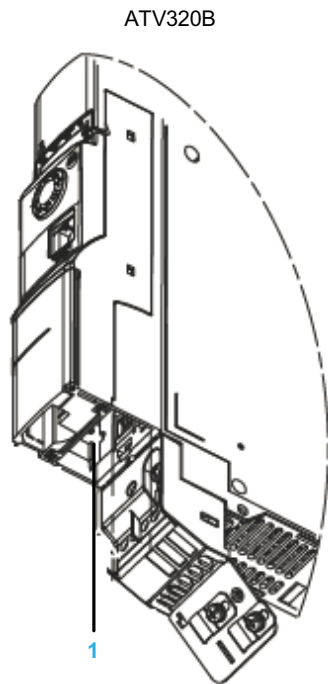

1. Slot A

Wiring

The VW3A3616 option card is equipped with 2 RJ45 female sockets for the Ethernet connection.

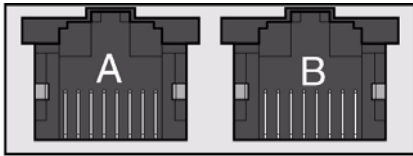

8 7 6 5 4 3 2 1 8 7 6 5 4 3 2 1

- Minimum Cat 5e,
- Use equipotential bonding conductors,
- Connector RJ45, no crossover cable
- Shield: both ends grounded
- Twisted pair cable
- Cable : 8 x 0.25 mm² (8 x AWG 22)
- Use pre-assembled cables to reduce the wiring mistakes,
- Verify that wiring, cables and connected interfaces meet the PELV requirements.
- Maximum cable length between devices = 100 m (328 ft)

The following table describes the pin out of each RJ45:

Pin	Signal	Meaning
1	Tx+	Ethernet transmit line +
2	Tx-	Ethernet transmit line -
3	Rx+	Ethernet receive line +
4	-	-
5	-	-
6	Rx-	Ethernet receive line -
7	-	-
8	-	-

Installation Topology

The VW3A3616 option module, with its 2 RJ45 connector, enables several wiring solutions:

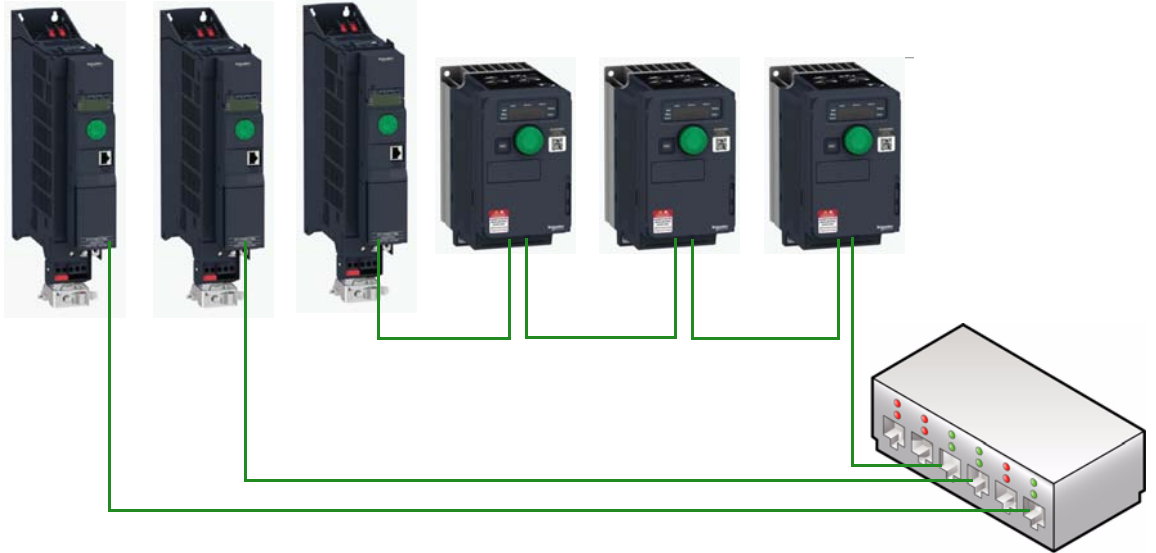

The following configuration **MUST NOT** be used:

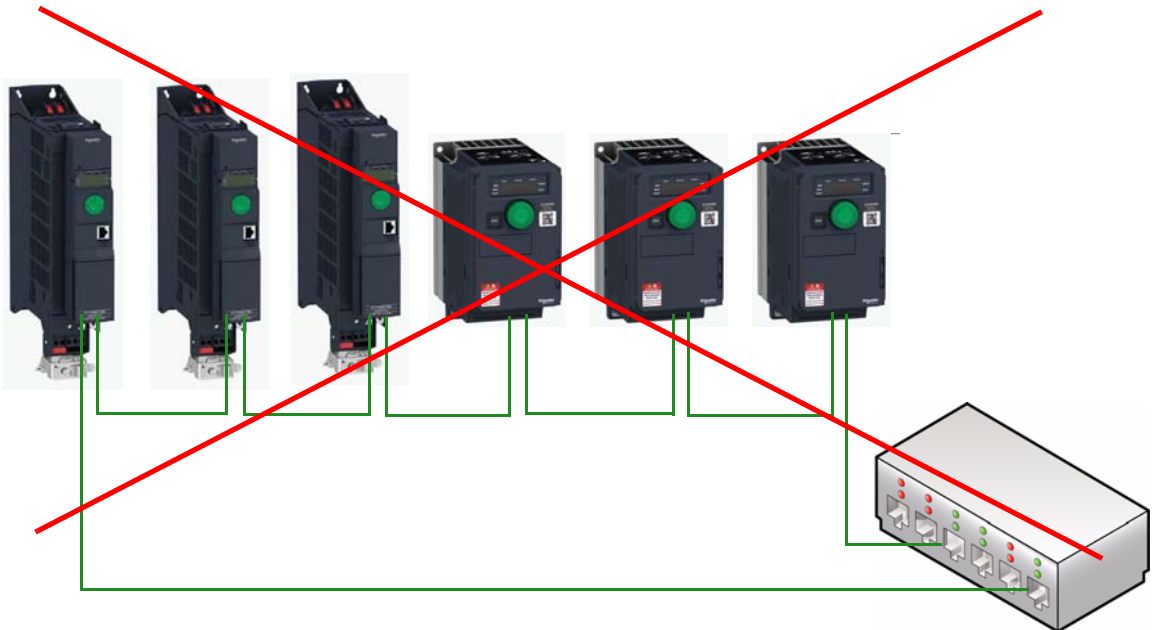

LED's Indicators

The following figures describes the LEDs status module:

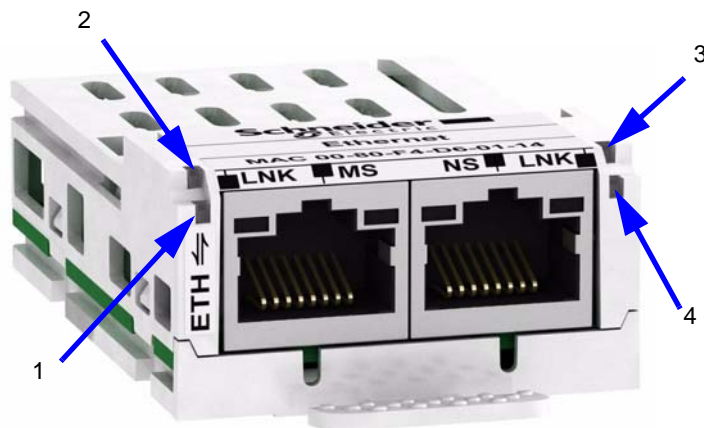

LED	Description
LNK (1)	Connection A port
MS (2)	Module status
NS (3)	Network status
LNK (4)	Connection B port

LEDs 1 and 4: Link Activity

These LEDs indicate the status of the Ethernet port A (1) and Ethernet port B (4):

	Color & Status	Description
EtherNet/IP & Modbus TCP	OFF	No link
	Flashing Green/Yellow	Power up testing
	Green ON	Link at 100Mbps
	Yellow ON	Link at 10 Mbps
	Green Blink	Activity at 100 Mbps
	Yellow Blink	Activity at 10 Mbps

LED 2: Module Status

This LED indicates the status of the module status:

	Color & Status	Description
EtherNet/IP	OFF	No power is supplied to the device
	Flashing Green/Red	Power up testing
	Green ON	The device is operating correctly.
	Green flashing	The device has not been configured
	Red flashing	The device has detected a recoverable minor detected fault
	Red on	The device has detected a non-recoverable major detected fault
Modbus TCP	OFF	The device does not have an IP address or powered off
	Flashing Green/Red	Power up testing
	Green ON	The device is ready
	Green flashing	The device is not ready (waiting for cable connection,...)
	Red flashing	The device has detected a (C n F)
	Red ON	The device has detected a (i L F)

LED 3: Network Status

This LED indicates the status of the module status:

	Color & Status	Description
EtherNet/IP	OFF	The device does not have an IP address or powered off
	Flashing Green/Red	Power up testing
	Green ON	The device has at least one established connection
	Green flashing	The device has no at least one established connection
	Red flashing	One or more of the connections in which this device is the target has timed out. This shall be left only if all time out connections are reestablished or if the device is reset.
	Red on	The device has detected that its IP address is already in use
Modbus TCP	OFF	The device does not have an IP address or powered off
	Flashing Green/Red	Power up testing
	Green ON	At least one port is connected and an IP ^o address has been obtained
	Green flashing 3 times	All ports are unplugged, but the card has an IP address
	Green flashing 4 times	Detected error: duplicate IP address
	Green flashing 5 times	The card is performing a BOOTP or DHCP sequence

LED Behavior Detail

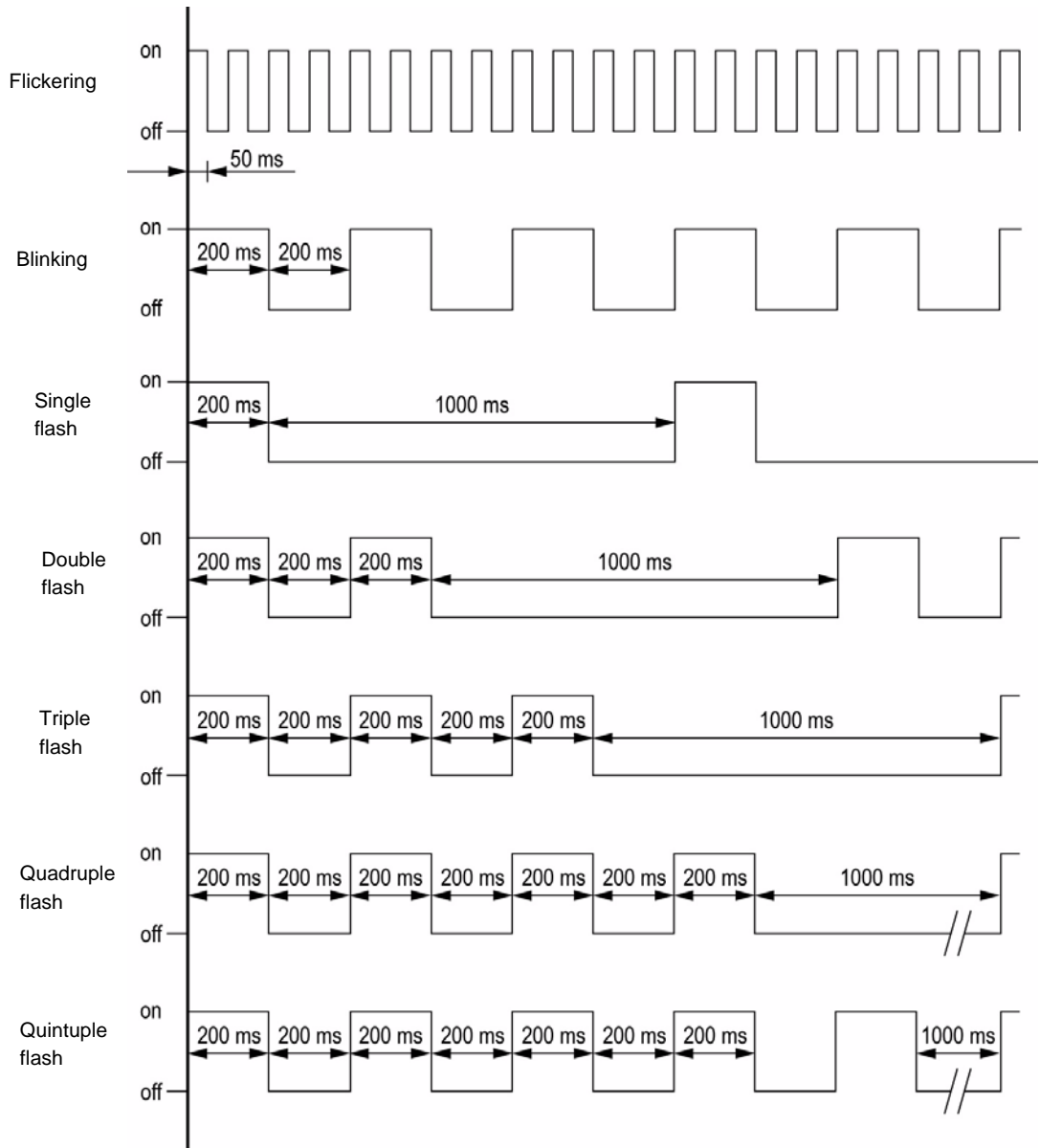

Configuration and Parameters

3

Overview

This chapter describes the parameters of the VW3A3616 module. These parameters are described here according to the local HMI or the Graphic keypad. These settings are also possible from SoMove or from the embedded web server.

What's in this Chapter?

This chapter contains the following topics:

Topic	Page
Network Settings	25
Modbus TCP Settings	27
FDR Settings	30
EtherNet/IP Settings	31
Monitoring of Communication Channels	32

Network Settings

The parameters are accessible via **[Configuration]** (CONF -), **[Full]** (FULL -), **[Communication]** (COM -) menu and **[Communication module]** (CbD -) submenu.

Parameter Description (HMI mnemonic)	Range or Listed Values	Default	Long Name	Short Name	Access	Parameter Number
[Ethernet protocol] (ETHN) This parameter defines which protocol is used for implicit exchanges	0: Modbus TCP 1: EtherNet/IP	0	[Modbus TCP] [Ethernet IP]	(NETP) (EIP)	R/W	64241
[Rate setting] (rds) Rate and data settings	0: Autodetect 1: 10 Mbps Full 2: 10 Mbps Half 3: 100 Mbps Full 4: 100 Mbps Half	Auto	[Auto] [10M. full] [10M. half] [100M. full] [100M. half]	(AUTO) (10F) (10H) (100F) (100H)	R/W	64251
[IP mode] (IPN) Use this parameter to select the IP address assignment method	0: Man 1: BOOTP 2: DHCP	DHCP	[Fixed] [BOOTP] [DHCP]	(IPMAN) (BOOTP) (DHCP)	R/W	64250
[IP module] (IPC) (IPC1)(IPC2)(IPC3)(IPC4) These fields are editable when IP mode is set to Fixed address	0 to 255 for each 4 fields	-	[139.160.069.241]	(139) (160) (069) (241)	R/W	64212 64213 64214 64215
[IP Mask] (IPN) (IPN1)(IPN2)(IPN3)(IPN4) These fields are editable when IP mode is set to Fixed address	0 to 255 for each 4 fields	-	[255.255.254.0]	(255) (255) (254) (0)	R/W	64216 64217 64218 64219
[IP Gate] (IPG) (IPG1)(IPG2)(IPG3)(IPG4) These fields are editable when IP mode is set to Fixed address	0 to 255 for each 4 fields	-	[0.0.0.0]	(0) (0) (0) (0)	R/W	64220 64221 64222 64223
[MAC @] (MAC) MAC address display	[00-80-F4-XX-XX-XX]	-	[00-80-F4-XX-XX-XX]	0080 F4--- XX XXXX	R	64267 64268 64269

NOTE: Before entry begins, the IP address displayed is the active IP address.

Assigning IP Addresses

The drive needs 3 IP addresses:

- The drive IP address.
- The subnet mask.
- The gateway IP address.

These IP addresses can be entered directly: Using the integrated display terminal. Using the graphic display terminal. Or using the SoMove software. They can be provided by:

- A BOOTP server (correspondence between the MAC address and the IP addresses).
- Or a DHCP server (correspondence between Device Name **[Device Name]** and the IP addresses).

If an IP address other than 0.0.0.0 has been entered using the display terminal or the SoMove software, assignment using a server is disabled.

Entering IP Addresses in the Terminal

In the **[Communication]** (*C o m -*) menu, **[Communication module]** (*C b d -*) submenu, enter the following IP addresses:

- **[IP card]** (*, P C 1*) (*, P C 2*) (*, P C 3*) (*, P C 4*),
- **[IP Mask]** (*, P M 1*) (*, P M 2*) (*, P M 3*) (*, P M 4*),
- **[IP Gate]** (*, P G 1*) (*, P G 2*) (*, P G 3*) (*, P G 4*).

Turn the drive off and then back on again (control voltage if a separate power supply is being used), otherwise the IP addresses are not taken into account.

If this address is modified, the new IP address entered is displayed. This IP address will be effective the next time the drive is turned on.

Configuring BOOTP

The BOOTP service is used to assign IP addresses from the MAC address. The MAC address consisting of 6 hexadecimal digits (00-80-F4-80-xx-yy) must be entered in the BOOTP server. The MAC address appears on the label attached to the Ethernet card.

In the **[Communication]** (*C o m -*) menu, **[Communication module]** (*C b d -*) submenu:

- Leave the IP address **[IP card]** (*, P C 1*) (*, P C 2*) (*, P C 3*) (*, P C 4*) at the value **[0.0.0.0]** (*(0) (0) (0) (0)*).
- Do not enable the FDR service: **[FDR Activation]** (*F d r u*) = **[No]** (*n o*).

Modbus TCP Settings

The parameters are accessible via **[Configuration]** (C o n F -), **[Full]** (F u l l -), **[Communication]** (C o m -) menu and **[Communication module]** (C b d -) submenu.

These settings are only visible when the parameter **[Ethernet protocol]** (E t h n) is defined on **[ModbusTCP]** (M b t P):

Parameter Description (HMI mnemonic)	Range or Listed Values	Default	Long Name	Short Name	Access	Parameter Number
[MAC @] (M A C) MAC address display	[00-80-F4-XX-XX-XX]	-	[00-80-F4-XX-XX-XX]	0080 F4--- XX XXXX	R	64267 64268 64269
[Rate setting] (r d S)	0: Autodetect 1: 10 Mbps Full 2: 10 Mbps Half 3: 100 Mbps Full 4: 100 Mbps Half	Auto	[Auto] [10M. full] [10M. half] [100M. full] [100M. half]	(R u t o) (1 0 F) (1 0 H) (1 0 0 F) (1 0 0 H)	R/W	64251
[Ethernet protocol] (E t h n)	0:Modbus TCP 1:EtherNet/IP	0	[Modbus TCP] [EthernetIP]	(M b t P) (E t , P)	R/W	64241
[IP mode] (, P n) Use this parameter to select the IP address assignment method	0: Man 1: BOOTP 2: DHCP	DHCP	[Fixed] [BOOTP] [DHCP]	(M a n) (b o o t) (d h c p)	R/W	64250
[IP Module] (, P C) (, P C 1)(, P C 2)(, P C 3) (, P C 4) These fields are editable when IP mode is set to Fixed address	0 to 255 for each 4 fields	0.0.0.0	[0.0.0.0]	(0) (0) (0) (0)	R/W	64212 64213 64214 64215
[IP Gate] (, P G) (, P G 1)(, P G 2)(, P G 3) (, P G 4) These fields are editable when IP mode is set to Fixed address	0 to 255 for each 4 fields	-	[0.0.0.0]	(0) (0) (0) (0)	R/W	64220 64221 64222 64223
[IP Master] (, P P) (, P P 1)(, P P 2)(, P P 3) (, P P 4) These fields define the address of the device which retains control of the drive	0 to 255 for each 4 fields	0.0.0.0	[0.0.0.0]	(0) (0) (0) (0)	R/W	64234 64235 64236 64237
[IP FDR] (, P F) (, P F 1)(, P F 2)(, P F 3) (, P F 4) These fields displays the served address of the FDR server	0 to 255 for each 4 fields	0.0.0.0	[0.0.0.0]	(0) (0) (0) (0)	R/W	64224 64225 64226 64227
[FDR Activation] (F d r a) Enable FDR service	0: no 1: yes	yes	[No] [Yes]	(n o) (y e s)	R/W	64228
[FDR Action] (F d r A)	NOT ACTIVE: No command SAVE: save command REST: download command DEL: delete command	IDLE	[NOT ACTIVE] [SAVE] [REST] [DEL]	(, d l e) (S a v e) (r e s t) (d e l)	R/W	64229
[FDR Autosave] (F d r S) Interval for periodic saving of the FDR service	0: no 1: yes	no	[No] [Yes]	(n o) (y e s)	R/W	64230
[FDR Autosave Timer] (F d r t)	0 to 9999 minutes	0	[0]	(0)	R/W	64231

Parameter Description (HMI mnemonic)	Range or Listed Values	Default	Long Name	Short Name	Access	Parameter Number
[FDR Status] (F d r E) FDR service status	- NOT ACTIVE: idle state - INIT: initialisation - CONF: configuration - RDY: ready - GET: download the current configuration - SET: save the current configuration - APP: Write the FDR server conf. to the drive - OPE: operational - UCFG: not configured	IDLE	[NOT ACTIVE] [INIT] [CONF] [RDY] [GET] [SET] [APP] [OPE] [UCFG]	(i d L E) (i n i t) (C o n F) (r d Y) (G E t) (S E t) (A P P) (o P E) (u C F G)	RW	64232
[FDR file error] (F d r F) Enable FDR detected fault management	0: no 1: yes	yes	[No] [Yes]	(n o) (Y E S)	R/W	64240
[Ethernet local conf] (L C F G) Selection of local or server configuration	0: no 1: yes	no	[No] [Yes]	(n o) (Y E S)	R/W	64238
[Eth IO scan act] (i o S A) Enable I/O scanner	0: no 1: Yes	-	[No] [Yes]	(n o) (Y E S)	R/W	64239
[Services] (E W E -) Enable web services	0: No web services 1: Web server enabled	1	-	-	R/W	-
[Ethernet Timeout] (E o u t) Ethernet timeout	0.5 to 60 s 0: disabled	2.0	[2.0s]	(2 . 0)	R/W	64211
[FDR Error Code] (F d r d) FDR error code	- 0: No error - 2: the FDR configuration file is not compatible with the drive type - 3: Detected error reading the FDR configuration file on the server - 4: Detected error writing the configuration file to the server - 7: Time out for receipt of the FDR configuration file from the server - 9: duplicated IP address. - 12: the FDR configuration file is missing - 13: the FDR configuration file deployment on the drive has detected an error (local detected error) - 14: the configuration file delete request has detected an error on the FDR server	0	[0] [2] [3] [4] [7] [9] [12] [13] [14]	(0) (2) (3) (4) (7) (9) (1 2) (1 3) (1 4)	R	64233
[Scan.Out1 address] (o C A 1) Scan Out 1 Modbus address	Eligible modbus address	CM	[OCA1]	(o C A 1)	R/W	15421
[Scan.Out2 address] (o C A 2) Scan Out 2 Modbus address	Eligible modbus address	LFRD	[OCA2]	(o C A 2)	R/W	15422
[Scan.Out3 address] (o C A 3) Scan Out 3 Modbus address	Eligible modbus address	0	[OCA3]	(o C A 3)	R/W	15423
[Scan.Out4 address] (o C A 4) Scan Out 4 Modbus address	Eligible modbus address	0	[OCA4]	(o C A 4)	R/W	15424
[Scan.Out5 address] (o C A 5) Scan Out 5 Modbus address	Eligible modbus address	0	[OCA5]	(o C A 5)	R/W	15425
[Scan.Out6 address] (o C A 6) Scan Out 6 Modbus address	Eligible modbus address	0	[OCA6]	(o C A 6)	R/W	15426
[Scan. IN1 address] (o P A 1) Scan In 1 Modbus address	Eligible modbus address	ETA	[OMA1]	(o P A 1)	R/W	15401
[Scan. IN2 address] (o P A 2) Scan In 2 Modbus address	Eligible modbus address	RFRD	[OMA2]	(o P A 2)	R/W	15402
[Scan. IN3 address] (o P A 3) Scan In 3 Modbus address	Eligible modbus address	0	[OMA3]	(o P A 3)	R/W	15403
[Scan. IN4 address] (o P A 4) Scan In 4 Modbus address	Eligible modbus address	0	[OMA4]	(o P A 4)	R/W	15404
[Scan. IN5 address] (o P A 5) Scan In 5 Modbus address	Eligible modbus address	0	[OMA5]	(o P A 5)	R/W	15405
[Scan. IN6 address] (o P A 6) Scan In 6 Modbus address	Eligible modbus address	0	[OMA6]	(o P A 6)	R/W	15406
[InternCom Error 1] (i L F 1) Option card 1 ILF Errors	Eligible modbus address	0	[-]	(-)	R/W	7134
[Fieldbus Com Interrupt] (C n F) Communication module error	Eligible modbus address	0	[-]	(-)	R/W	7132

- If control has been reserved: only the control word (**C P d**) written by the master with control will be accepted via I/O Scanning or via Modbus TCP messaging. Two TCP connections are reserved for this device. In this way, you avoid other TCP clients using all the available connections (8 maximum) and the control master therefore no longer being able to access the drive Modbus TCP server.

NOTE: Other parameters written from other IP addresses are accepted (for example, adjustments or writing a setpoint). When control has been reserved and another device attempts to write the control word (**C P d**):

- via I/O Scanning: The Modbus TCP connection for this client is immediately reinitialized.
 - via Modbus TCP messaging: Control is denied.
- If control has not been reserved (**[IP Master] = [0.0.0.0] (D) (D) (D) (D)**), control can come from any IP address.

Configuring I/O Scanning

The drive I/O Scanning service can be enabled or disabled in the **[Communication] (C o n -)** menu, **[Communication module] (C b d -)** submenu via parameter **[Eth IO scan act] (i o S A)**.

It is not possible to modify the assignment of the I/O Scanning periodic variables using the display terminal (integrated or graphic). To configure I/O Scanning, use the standard Web server or the SoMove software.

FDR Settings

The parameters are accessible via **[Configuration]** (CONF -), **[Full]** (FULL -), **[Communication]** (COM -) menu and **[Communication module]** (CbD -) submenu.

The following table describes the parameters related to the “Fast device replacement settings”. More information about FDR settings can be found in “FDR Settings” on page 103

Parameter Description (HMI mnemonic)	Range or Listed Values	Default	Long Name	Short Name	Access	Parameter Number
[IP FDR] (IPF) (IPF1)(IPF2)(IPF3) (IPF4) These fields displays the served address of the FDR server	0 to 255 for each 4 fields	0.0.0.0	[0.0.0.0]	(0) (0) (0) (0)	R/W	64224 64225 64226 64227
[FDR Activation] (FDRU) Enable FDR service	0: no 1: yes	yes	[No] [Yes]	(no) (YES)	R/W	64228
[Ethernet local conf] (LCFG) Selection of local or server configuration	0: no 1: yes	no	[No] [Yes]	(no) (YES)	R/W	64238
[FDR file error] (FDRF) Enable FDR error management	0: no 1: yes	yes	[No] [Yes]	(no) (YES)	R/W	64240
[FDR Action] (FDRR) SAVE: save command REST: download command DEL: delete command	NOT ACTIVE: No command	IDLE	[NOT ACTIVE] [SAVE] [REST] [DEL]	(idle) (SAVE) (REST) (DEL)	R/W	64229
[FDR Autosave] (FDRS) Interval for periodic saving of the FDR service	0: no 1: yes	no	[No] [Yes]	(no) (YES)	R/W	64230
[FDR Autosave Timer] (FDRTE) FDR service status	0 to 9999 minutes	0	[0]	(0)	R/W	64231
[FDR Status] (FDRS) FDR service status	- NOT ACTIVE: idle state - INIT: initialisation - CONF: configuration - RDY: ready - GET: download the current configuration - SET: save the current configuration - APP: Write the FDR server conf. to the drive - OPE: operational - UCFG: not configured	IDLE	[NOT ACTIVE] [INIT] [CONF] [RDY] [GET] [SET] [APP] [OPE] [UCFG]	(idle) (init) (CONF) (RDY) (GET) (SET) (APP) (OPE) (UCFG)	RW	64232
[FDR Error Code] (FDRD) FDR service status	- 0: No error - 2: the FDR configuration file is not compatible with the drive type - 3: Detected error reading the FDR configuration file on the server - 4: Detected error writing the configuration file to the server - 7: Time out for receipt of the FDR configuration file from the server - 9: duplicated IP address. - 12: the FDR configuration file is missing - 13: the FDR configuration file deployment on the drive has detected an error (local detected error) - 14: the configuration file delete request has detected an error on the FDR server	0	[0] [2] [3] [4] [7] [9] [12] [13] [14]	(0) (2) (3) (4) (7) (9) (12) (13) (14)	R	64233

NOTE: During the application of the configuration, the option use the File Transfer mechanism (FTP) and some system services. If all the transfers are well finished, the operational state is reached. If the configuration is ok: the operational state is reached, else if the configuration is not ok: the unconfigured state is reached (FDR error #14).

EtherNet/IP Settings

The parameters are accessible via **[Configuration]** (C O N F -), **[Full]** (F U L L -), **[Communication]** (C O M -) menu and **[Communication module]** (C b d -) submenu.

These settings are only visible when the parameter **[Ethernet protocol]** (E t H n) is defined on **[EthernetIP]** (E t , P):

Parameter Description (HMI mnemonic)	Range or Listed Values	Default	Long Name	Short Name	Access	Parameter Number
[MAC @] (n a c) MAC address display	[00-80-F4-XX-XX-XX]	-	[00-80-F4-XX-XX-XX]	0080 F4--- XX XXXX	R	64267 64268 64269
[Rate setting] (r d 5)	0: Autodetect 1: 10 Mbps Full 2: 10 Mbps Half 3: 100 Mbps Full 4: 100 Mbps Half	Auto	[Auto] [10M. full] [10M. half] [100M. full] [100M. half]	(R u t o) (1 0 F) (1 0 H) (1 0 0 F) (1 0 0 H)	R/W	64251
[Ethernet protocol] (E t H n)	0:Modbus TCP 1:EtherNet/IP	0	[Modbus TCP] [EthernetIP]	(n b t P) (E t , P)	R/W	64241
[IP mode] (, P n) Use this parameter to select the IP address assignment method	0: Man 1: BOOTP 2: DHCP	DHCP	[fixed] [BOOTP] [DHCP]	(n P n u) (b o o t P) (d H C P)	R/W	64250
[IP Module] (, P C) (, P C 1)(, P C 2)(, P C 3) (, P C 4) These fields are editable when IP mode is set to Fixed address	0 to 255 for each 4 fields	0.0.0.0	[0.0.0.0]	(0) (0) (0) (0)	R/W	64212 64213 64214 64215
[IP Gate] (, P G) (, P G 1)(, P G 2)(, P G 3) (, P G 4) These fields are editable when IP mode is set to Fixed address	0 to 255 for each 4 fields	-	[0.0.0.0]	(0) (0) (0) (0)	R/W	64220 64221 64222 64223
[Conf. Assembly] (C , o 2) Configured output assembly	20,21,100, 101	20	[20]	-	R	-
[Services] (E W E -) Enable web services	0: No web services 1: Web server enabled	1	-	-	R/W	-
[Scan.Out1 address] (o C R 1)	Eligible modbus address	CMD	[OCA1]	(o C R 1)	R/W	15421
[Scan.Out2 address] (o C R 2)	Eligible modbus address	LFRD	[OCA2]	(o C R 2)	R/W	15422
[Scan.Out3 address] (o C R 3)	Eligible modbus address	0	[OCA3]	(o C R 3)	R/W	15423
[Scan.Out4 address] (o C R 4)	Eligible modbus address	0	[OCA4]	(o C R 4)	R/W	15424
[Scan.Out5 address] (o C R 5)	Eligible modbus address	0	[OCA5]	(o C R 5)	R/W	15425
[Scan.Out6 address] (o C R 6)	Eligible modbus address	0	[OCA6]	(o C R 6)	R/W	15426
[Scan. IN1 address] (o n R 1)	Eligible modbus address	ETA	[OMA1]	(o n R 1)	R/W	15401
[Scan. IN2 address] (o n R 2)	Eligible modbus address	RFRD	[OMA2]	(o n R 2)	R/W	15402
[Scan. IN3 address] (o n R 3)	Eligible modbus address	0	[OMA3]	(o n R 3)	R/W	15403
[Scan. IN4 address] (o n R 4)	Eligible modbus address	0	[OMA4]	(o n R 4)	R/W	15404
[Scan. IN5 address] (o n R 5)	Eligible modbus address	0	[OMA5]	(o n R 5)	R/W	15405
[Scan. IN6 address] (o n R 6)	Eligible modbus address	0	[OMA6]	(o n R 6)	R/W	15406
[InternCom Error1] (, L F 1) Communication interruption between option card 1 and drive	Eligible modbus address	0	[-]	(-)	R/W	7134
[Fieldbus Com Interrupt] (C n F) Communication module error	Eligible modbus address	0	[-]	(-)	R/W	7132

Monitoring of Communication Channels

Command and Reference Channels

All the drive's command and reference parameters are managed on a channel-by-channel basis.

It is possible to identify the last value written for each channel and each command or reference parameter:

Parameter name	Parameter code			
	Taken into account by the drive	Modbus	CANopen	Communication card
Control word	(C P d)	(C P d 1)	(C P d 2)	(C P d 3)
Extended control word	(C P i)	(C P i 1)	(C P i 2)	(C P i 3)
Speed reference (rpm)	(L F r d)	(L F r d 1)	(L F r d 2)	(L F r d 3)
Frequency reference (0.1 Hz)	(L F r)	(L F r 1)	(L F r 2)	(L F r 3)
PI regulator reference	(P i S P)	(P i r 1)	(P i r 2)	(P i r 3)
Analog multiplier reference	(P F r)	(P F r 1)	(P F r 2)	(P F r 3)

Network Monitoring Criteria

The network is monitored according to the protocol-specific criteria.

Protocol	Criteria	Related detected fault
Integrated Modbus port	Adjustable time-out for received requests destined for the drive.	[Modbus Com Interruption] (S L F)
Ethernet card	FDR detected fault IP address duplication detected fault Adjustable time-out for received control word (I/O scanning or messaging) Network overload	[Fieldbus Error] (E P F 2) [Fieldbus Com Interruption] (C n F)

Monitoring of Communication Channels

Communication channels are monitored if they are involved in one of the following parameters:

- The control word ([Cmd Register] (C P d)) from the active command channel
- The control word containing the command switch (bit configured on [Command Switching] (C C 5))
- The control word containing the switch for reference 1'1B (bit configured on [Ref 1B switching] (r C b))
- The control word containing the switch for reference 1'2 (bit configured on [Freq Switch Assign] (r F C))
- The frequency or speed reference ([Ref Frequency] (L F r) or LFRD: Nominal speed value) from the active reference channel
- Summing frequency or speed reference ([Ref Frequency] (L F r) or LFRD: Nominal speed value) 2 (assigned to [Summing Input 2] (S A 2))
- Summing frequency or speed reference ([Ref Frequency] (L F r) or LFRD: Nominal speed value) 3 (assigned to [Summing Input 3] (S A 3))
- Subtracting frequency or speed reference ([Ref Frequency] (L F r) or LFRD: Nominal speed value) 2 (assigned to [Subtract Ref Freq 2] (d A 2))
- Subtracting frequency or speed reference ([Ref Frequency] (L F r) or LFRD: Nominal speed value) 3 (assigned to [Subtract Ref Freq 3] (d A 3))
- The PID regulator reference (PISP)
- The PID regulator feedback ([AI Virtual 2] (A i u 2))
- The reference multiplication coefficient ([Multiplying coeff.] (P F r)) 2 (assigned to [Ref Freq 2 Multiply] (P A 2))
- The reference multiplication coefficient ([Multiplying coeff.] (P F r)) 3 (assigned to [Ref Freq 3 Multiply] (P A 3))

As soon as one of these parameters has been written once to a communication channel, it activates monitoring for that channel.

If a communication alarm is sent (in accordance with the protocol criteria) by a monitored port or network card, the drive will trigger a communication interruption.

The drive reacts according to the communication interruption configuration (detected fault, maintenance, fallback, etc.)

If a communication alarm occurs on a channel that is not being monitored, the drive will not trigger a communication interruption.

Enabling of Communication Channels

A communication channel is enabled once all the parameters involved have been written at least one time. The drive is only able to start if all channels involved in command and reference are enabled.

Example:

A drive in DSP402 profile is connected to an active communication channel.

It is mandatory to write at least one time the reference and the command in order to switch from "4-Switched on" to "5-Operation enabled" state

A communication channel is disabled:

- In the event of a communication alarm
- In "forced local" mode.

Note: On exiting "forced local" mode:

- The drive copies the run commands, the direction and the forced local reference to the active channel (maintained).
- Monitoring of the active command and reference channels resumes following a time delay **[Time-out forc. local] (FL o t)**.
- Drive control only takes effect once the drive has received the reference and the command from the active channel.

Configuration of the Drive Commands Settings

4

Overview

This chapter explains how to configure the drive for operation from communication network through 3 following examples:

- I/O Mode - a simple command Word (based on forward, reverse and reset binary commands).
- Combined Mode (with native profile CiA402) - Both reference and command word come from the communication network.
- Separate (with native profile CiA402) - Reference and command word come from separate sources: for example, the command word (in CiA402) comes from the communication network and the reference word from the HMI.

What's in this Chapter?

This chapter contains the following topics:

Topic	Page
Configuration of the Drive for Operation in I/O Profile	35
Configuration of the Drive for Operation With CiA402 Profile in Combined Mode	36
Configuration of the Drive for Operation With CiA402 Profile in Separate Mode	36

Configuration of the Drive for Operation in I/O Profile

To illustrate the I/O Profile, we will describe a simple example, which can be of course extended with additional features. The Command word is made of Run forward (bit 0 of **CMD**), run reverse (bit 1 of **CMD**), and a detected fault reset (bit 7 of **CMD**).

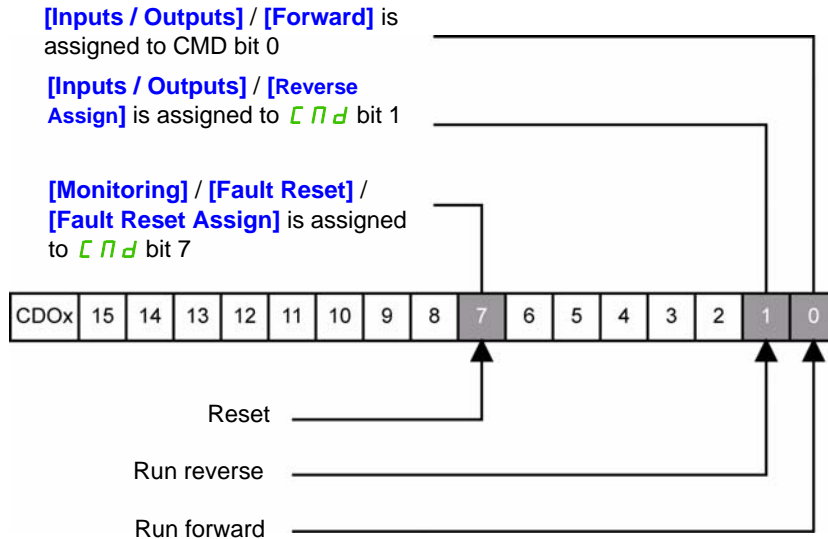

The settings will be the following:

[Ref Freq 1 Config] (<i>Fr I</i>)	[Ref.Freq-Rmt.Term] (<i>L L L</i>) (for example)
[Reverse Disable] (<i>r r n</i>)	Default
[Stop Key Enable] (<i>P S E</i>)	Default
[Control Mode] (<i>C H C F</i>)	[I/O profile] (<i>i o</i>)
[Command Switching] (<i>C C S</i>)	Default
[Cmd channel 1] (<i>C d I</i>)	[Com. Module] (<i>n E E</i>)

The bits of the command word must now be configured.

In the **[Inputs / Outputs]** Menu, configure:

[Forward] (<i>Fr d</i>)	[Cd00] (<i>C d 0 0</i>)
[Reverse Assign] (<i>r r S</i>)	[Cd01] (<i>C d 0 1</i>)

In the **[Monitoring]** menu, **[Fault reset]** submenu, configure:

[Fault Reset Assign] (<i>r S F</i>)	[Cd07] (<i>C d 0 7</i>)
--	----------------------------------

Configuration of the Drive for Operation With CiA402 Profile in Combined Mode

This chapter describes how to configure the settings of the drive if it is controlled in CiA402 Mode. The example focuses on the Not separate mode (Combined). Additional modes such as the separate Mode are detailed in the ATV320 Programming manual.

In the Command Menu **[Command]** (C E L -):

- **[Ref Freq 1 Config]** (F r I): is set according to the communication source you can choose in the following table:

Origin of the control	Ref1 Channel setting
EtherNet/IP - Modbus TCP	[Ref. Freq-Com. Module] (n E E)

- **[Control Mode]** (C H C F): defines if the drive operates in combined mode (reference and command from the same channel).

Configuration of the Drive for Operation With CiA402 Profile in Separate Mode

Alternate combinations are possible, see the ATV320 programming manual for the list of possible settings.

Example:

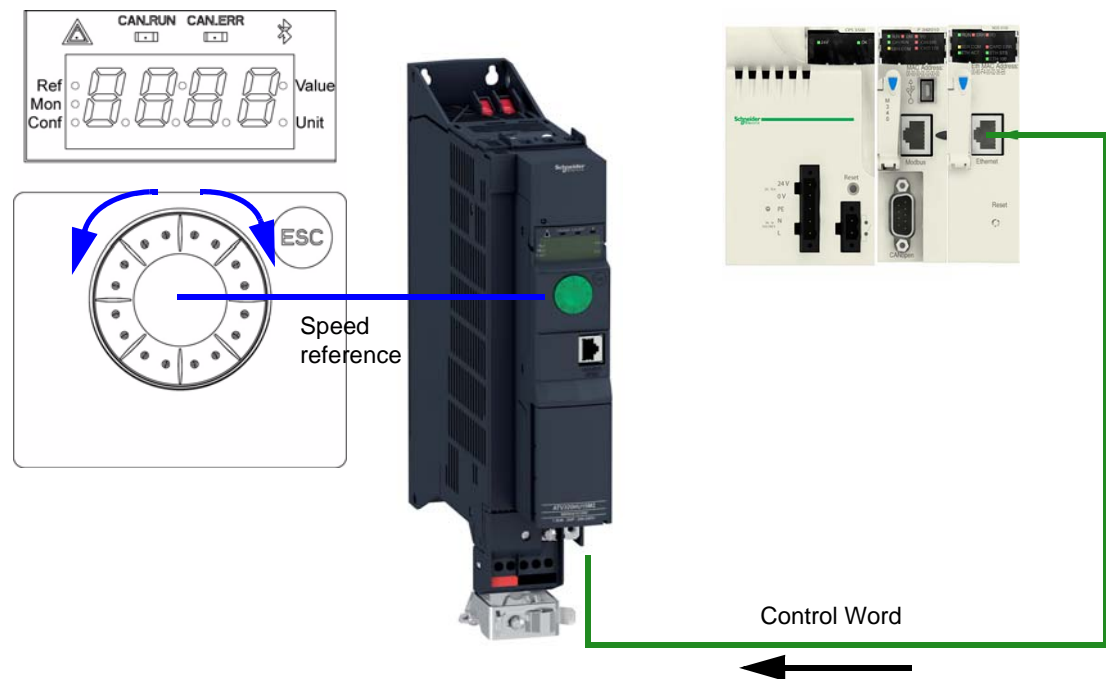

The drive is controlled from the communication (EtherNet) but the reference is adjusted on the local HMI. The control word comes from the controller and is written according to CiA402 profile.

The settings will be as follows:

[Ref Freq 1 Config] (F r I)	[AI virtual 1] (R I U I)
[Reverse Disable] (r n)	Default
[Stop Key enable] (P S E)	Default
[Control Mode] (C H C F)	[Separate] (S E P)
[Command switching] (C C S)	Default
[Cmd channel 1] (C d I)	[Com. module] (n E E)

Network Layer Supported Functions/Protocols

5

ARP, ICMP and IP Protocol

ARP Protocol

The ARP (Address Resolution Protocol) is a protocol used by the IP (Internet Protocol) network layer protocol to map IP network addresses to hardware addresses (MAC address). The protocol operates below the network layer as a part of the OSI link layer, and is used when IP is used over Ethernet.

A host, wishing to obtain a physical address, broadcasts an ARP request onto the TCP/IP network. The host on the network, that has the IP address in the request, then replies with its physical HA (Hardware Address).

There are four types of ARP messages which may be sent by the ARP protocol. They are identified by two values in the "operation" field of an ARP message. The types of message are: ARP request; ARP reply.

The following table describes the format of an ARP message:

0	8	15	16	31
Hardware Type		Protocol Type		
HLEN (Hardware address Length)	PLEN (Protocol address Length)	Operation		
Sender HA (bytes 0-3)				
Sender HA (bytes 4-5)			Sender IP (bytes 0-1)	
Sender IP (bytes 2-3)			Target HA (bytes 0-1)	
Target HA (bytes 2-5)				
Target IP (bytes 0-3)				

ARP frames are described as follows:

- ARP Request: it allows to get the hardware (MAC) Address of a remote device.
- Gratuitous ARP: it allows to announce the use of an IP and Hardware Addresses.
- ARP Probe: it allows questioning the network to know if an IP Address is already used without updating the ARP table of the other hosts on the network.

The following table describes the ARP frames:

	ARP Request	Gratuitous ARP / Response	ARP Probe
Sender IP Address	Local IP Address	Local IP Address	Zero
Sender Hardware Address	Local MAC Address	Local MAC Address	Local MAC Address
Target IP Address	Non-zero (!= Sender IP Address)	Local IP Address (= Sender IP Address)	IP Address to probe
Target Hardware Address	Zero	Non significant	Zero

ICMP Protocol

The Option board manages the ICMP protocol.

- ICMP client: not supported
- ICMP server: the managed requests are the following:

Type	Description	Type	Description
0	Echo reply (ping)	11	Time exceeded
3	Destination unreachable	12	Parameter problem
4	Source quench	13	Timestamp request
5	Redirect	14	Timestamp reply
6	Alternate Host Address	15	Information request
8	Echo request (ping)	16	Information reply
9	Router advertisement	17	Address mask request
10	Router solicitation	18	Address mask reply

IP Protocol

The OB (Option Board) implements the IP protocol V4.

SNMP Services

The VW3A3316 accepts the Community Name "Schneider" for Reading/Writing and the Community Name "Public" for Reading only.

MIB

Objects	Description	Access	Default Value
SysDescr	Text description of the product	RO	Schneider Electric Altivar Fast Ethernet TCP/IP Module
SysObjectID	Points in the private MIB on the product reference	RO	1.3.6.1.4.1.3833.1.7.255.6
SysUpTime	Time elapsed since the last power up	RO	Managed by the option
SysContact	Information allowing to contact the node manager	R/W	" "
SysName	Node administrative name	R/W	"ATV" or FDR device name if configured
SysLocation	Physical location of the product	R/W	" "
SysService	Indicates the service type offered by the product.	RO	72

Transport Layer Protocols

6

TCP and UDP Protocol

Connections

The VW3A3616 supports maximum 8 concurrent TCP connections.

The VW3A3616 device, according to EtherNet/IP specifications, supports:

- 3 concurrent encapsulation sessions,
- 6 concurrent transport class 3 explicit messaging connections,
- more than 1 transport class 3 connection per encapsulation session.

BOOTP and DHCP Protocol

The VW3A3616 can use BOOTP and DHCP protocols.

BOOTP & DHCP protocol frames

The following table describes the DHCP frame format:

OP (1byte)	HTYPE (1 byte)	HLEN (1 byte)	HOPS (1 byte)
XID (4 bytes)			
SECS (2 bytes)		FLAGS (2 bytes)	
CIADDR (4 bytes)			
YIADDR (4 bytes)			
SIADDR (4 bytes)			
GIADDR (4 bytes)			
CHADDR (16 bytes)			
SNAME (64 bytes)			
FILE (128 bytes)			
OPTIONS (312 bytes)			

The BOOTP frame is the same: only the VW3A3616 OP field is different.

DHCP frame fields are described as follows:

Field	Description
op	Message type DHCP Request / DHCP Reply
htype	Address hardware type
hlen	Hardware address length
hops	Used by relay agent
xid	Transaction identifier, random number chosen by the client allowing to associate the request and the response
secs	Time in seconds since the beginning of the transaction
flags	First bit used for the Broadcast reply flag
ciaddr	Client IP address, only used if the client can respond to ARP request
yiaddr	Client IP address, "your" IP address proposed by the server
siaddr	IP address of the server
giaddr	Gateway IP address, used when a relay agent needs to be crossed
sname	Server Name
file	Location of boot file
options	Optional parameters with DHCP extensions

DHCP messages

The DHCP protocol uses 8 different types of message during the IP assigning process.

The following table describes the 8 messages:

Message	Description
DISCOVER	The client tries to discover the DHCP server using a broadcast
OFFER	The server proposes a configuration
REQUEST	The client chooses a DHCP server and declines other offers
ACK	The chosen server assigns the IP configuration
NAK	The server rejects the client request
DECLINE	The client declines the assigned IP configuration
RELEASE	The client releases its IP address before the end of the lease
INFORM	The client asks for network information (it already has an IP address)

Operating mode

The choice between DHCP, BOOTP and manual configuration is made through one parameter:

- Manual mode: the VW3A3616 uses the address stored in parameter.
- BOOTP: card receives the addresses from BOOTP server.
- DHCP: if the Altivar Device name [XXX] is a valid name, the VW3A3616 receives the addresses from the DHCP server.

Modbus TCP Features



7

What's in this Chapter?

This chapter contains the following topics:

Topic	Page
Modbus TCP Frames	42
ATV320 and VW3A3616: Modbus Servers	42
Supported Modbus Functions	43
Application Profile with Modbus TCP	48
Configuring Communication Detected Fault Management	49
Configuring Monitor Parameters	51

Modbus TCP Frames

TCP Telegrams

Modbus TCP telegrams are not only Modbus standard requests and responses encapsulated in TCP frames.

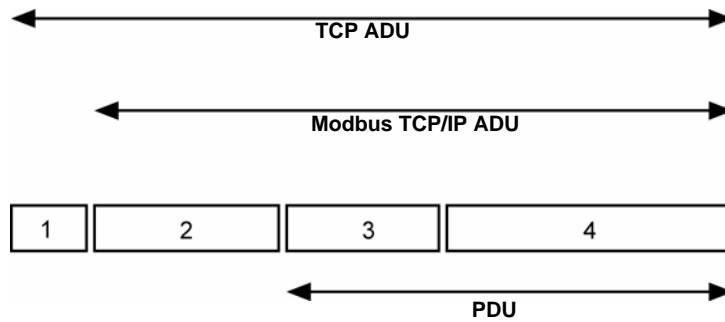

- (1) TCP header
- (2) MBPA: Modbus Application Protocol Header
- (3) ADU: Application data Unit
- (4) PDU: Protocol data Unit (The Modbus Message itself)

MBAP Header Structure

Fields	Length	Description	Client	Server
Transaction Identifier	2 Bytes	Identification of a Modbus request / response transaction	Initialized by the client	Recopied by the server from the received request
Protocol Identifier	2 Bytes	0= Modbus protocol	Initialized by the client	Recopied by the server from the received request
Length	2 Bytes	Number of following bytes	Initialized by the client (request)	Initialized by the server (response)
Unit Identifier	1 Byte	Identification of a remote slave connected on a serial line or on other buses	Initialized by the client	Recopied by the server from the received request

ATV320 and VW3A3616: Modbus Servers

Unit ID	Modbus TCP server	Accessible parameters
0	Variable speed drive	See ATV320 Communication parameters
251	Ethernet card	See ATV320 Communication parameters
255	I/O scanner	See "I/O Scanner Setting" on page 48

Supported Modbus Functions

Modbus Services

The Modbus TCP option supports the following Modbus services:

Function Name	Code	Description	Remarks
Read holding registers	03 16#03	Read N output words	Max PDU length: 63 words
Write one output word	06 16#06	Write one output word	
Write multiple registers	16 16#10	Write N output word	Max PDU length: 63 words
Read/write Multiple registers	23 16#17	Read/write multiple registers	Max PDU length: 20 words (W), 20 words ®
(Sub-function) Read device Identification	43/14 16#2B 16#0E	Encapsulated interface transport / Read device identification	See the table below

NOTE: I/O scanner service is based on the function 23. To avoid unpredictable behavior, priority should be given to this function with regards to the functions 6 and 16.

Parameters in Option Board EtherNet

Description	OptMb (Option)	AdL (Drive)	Type	R/W-NV	Short label	Long Label	Range list values Comments / Units
	MB Address	MB Address		access	HMI Name	Graphic Keypad Name	Valid values
Network							
Rate setting	60108	64251	UINT8 / LIST	R/W-NV	<i>r d S</i>	Rate setting	Default value : 0
					<i>R u b a</i>	Auto	0 = Autodetect
					10M. Full	10F	1 = 10 Mbps Full
					10M. Half	10H	2 = 10 Mbps Half
					100M. Full	100F	3 = 100 Mbps Full
					100M. Half	100H	4 = 100 Mbps Half
Actual Rate Left port	60109	—	UINT8 / LIST	R	<i>R r d L</i>	—	—
							0 = No Link
							1 = 10 Mbps Full
							2 = 10 Mbps Half
							3 = 100 Mbps Full
						4 = 100 Mbps Half	
Actual Rate Right port	60110	—	UINT8 / LIST	R	<i>R r d r</i>	—	—
							0 = No Link
							1 = 10 Mbps Full
							2 = 10 Mbps Half
							3 = 100 Mbps Full
						4 = 100 Mbps Half	
EEPROM value of IP Address	60006	64212	—	R/W-NV	<i>, P C</i>	IP card	IPC1.IPC2.IPC3.IPC4 Default value : 0.0.0.0
	60006	64212	UINT8	UINT8	<i>, P C 1</i>	IP card 1	0-255
	60007	64213			<i>, P C 2</i>	IP card 2	
	60008	64214			<i>, P C 3</i>	IP card 3	
	60009	64215			<i>, P C 4</i>	IP card 4	
EEPROM value of Subnet mask	60010	64216	—	R/W-NV	—	IP mask	IPM1.IPM2.IPM3.IPM4 Default value : 0.0.0.0
	60010	64216	UINT8	—	<i>, P N 1</i>	IP mask 1	0-255
	60011	64217			<i>, P N 2</i>	IP mask 2	
	60012	64218			<i>, P N 3</i>	IP mask 3	
	60013	64219			<i>, P N 4</i>	IP mask 4	
EEPROM value of Gateway Address	60014	64220	—	R/W-NV	<i>, P G</i>	IP gate	IPG1.IPG2.IPG3.IPG4 Default value : 0.0.0.0
	60014	64220	UINT8	—	<i>, P G 1</i>	IP gate 1	0-255
	60015	64221			<i>, P G 2</i>	IP gate 2	
	60016	64222			<i>, P G 3</i>	IP gate 3	
	60017	64223			<i>, P G 4</i>	IP gate 4	
Current value of IP Address	60075	64252	—	R	<i>, P A</i>	Actual IP	ICA1.ICA2.ICA3.ICA4 Default value : 0.0.0.0
	60075	64252	UINT8	—	<i>, C A 1</i>	IP card actual 1	0-255
	60076	64253			<i>, C A 2</i>	IP card actual 2	
	60077	64254			<i>, C A 3</i>	IP card actual 3	
	60078	64255			<i>, C A 4</i>	IP card actual 4	
Current value of Subnet mask	60079	64256	—	R	<i>, P S</i>	Actual mask	IMA1.IMA2.IMA3.IMA4
	60079	64256	UINT8	—	<i>, P A 1</i>	IP mask actual 1	0-255
	60080	64257			<i>, P A 2</i>	IP mask actual 2	
	60081	64258			<i>, P A 3</i>	IP mask actual 3	
	60082	64259			<i>, P A 4</i>	IP mask actual 4	
Current value of Gateway Address	60083	64260	—	R	<i>, P E</i>	Actual gate.	IGA1.IGA2.IGA3.IGA4
	60083	64260	UINT8	—	<i>, G A 1</i>	IP gate actual 1	0-255
	60084	64261			<i>, G A 2</i>	IP gate actual 2	
	60085	64262			<i>, G A 3</i>	IP gate actual 3	
	60086	64263			<i>, G A 4</i>	IP gate actual 4	

Description	OptMb (Option)	AdL (Drive)	Type	R/W-NV	Short label	Long Label	Range list values
	MB Address	MB Address		access	HMI Name	Graphic Keypad Name	Comments / Units Valid values
MAC address	60000	—	—	R	—	—	MAC1:MAC2:MAC3 MAC4:MAC5:MAC6
	60000	64267	UINT8/UINT16	—	<i>MAC1</i>	MAC1 / MAC2:MAC1	0-255
	60001	—	UINT8		<i>MAC2</i>	MAC2	
	60002	64268	UINT8/UINT16		<i>MAC3</i>	MAC3 / MAC4:MAC3	
	60003	—	UINT8		<i>MAC4</i>	MAC4	
	60004	64269	UINT8/UINT16		<i>MAC5</i>	MAC5 / MAC6:MAC5	
	60005	—	UINT8		<i>MAC6</i>	MAC6	
IO Scanner							
Enable IO Scanner	60048	64239	UINT8 / LIST	R/W-NV	<i>IOSA</i>	IO Scan. activ.	Default value : 0
					<i>OFF</i>	OFF	0 = Disable
					<i>ON</i>	ON	1 = Enable
IP address of Master	60050	64234	—	R/W-NV	<i>IPP</i>	IP Master	IPP1.IPP2.IPP3.IPP4 Default value : 0.0.0.0
	60050	64234	UINT8	—	<i>IPP1</i>	IP Master 1	0-255
	60051	64235			<i>IPP2</i>	IP Master 2	
	60052	64236			<i>IPP3</i>	IP Master 3	
	60053	64237			<i>IPP4</i>	IP Master 4	
Communication monitoring time out	60045	64211	UINT16	R/W-NV	<i>TOU</i>	time out	Default value:20 Unit : 0.1 sec
	—			—	—	—	0.20-600
FDR							
IP address of DHCP-FDR server	60054	64224	—	R	<i>IPF</i>	IP FDR	IPF1.IPF2.IPF3.IPF4
	60054	64224	UINT8	—	<i>IPF1</i>	IP FDR 1	0-255
	60055	64225			<i>IPF2</i>	IP FDR 2	
	60056	64226			<i>IPF3</i>	IP FDR 3	
	60057	64227			<i>IPF4</i>	IP FDR 4	
Enable FDR service	60058	64228	UINT8 / LIST	R/W-NV	<i>FDRU</i>	FDR validation	Default value : 1
					<i>NO</i>	No	0 = Disable
					<i>YES</i>	Yes	1= Enable
Select local configuration	60059	64238	UINT8 / LIST	R/W-NV	<i>LCFG</i>	FDR Local Config.	Default value : 0
					<i>OFF</i>	OFF	0 = Disable The drive configuration is downloaded from a FDR server)
					<i>ON</i>	ON	1= Enable The drive configuration is local
Enable FDR fault	60060	64240	UINT8 / LIST	R/W-NV	<i>FDRF</i>	FDR Error management	In the event of a problem with the FDR file (missing or invalid) Default value : 1
					<i>OFF</i>	OFF	0 = Disable The Ethernet card does not trigger an Ethernet fault)
					<i>ON</i>	ON	1= Enable The Ethernet card triggers an Ethernet fault)
FDR Action	60061	64229	UINT8 / LIST	R/W	<i>FDR A</i>	FDR Action	—
					<i>IDLE</i>	NOT ACTIVE	0 = Idle
					<i>SAVE</i>	SAVE	1 = Save
					<i>REST</i>	REST	2 = Restore
					<i>DEL</i>	DEL	3 = Delete

Description	OptMb (Option)	AdL (Drive)	Type	R/W-NV	Short label	Long Label	Range list values
	MB Address	MB Address		access	HMI Name	Graphic Keypad Name	Comments / Units Valid values
FDR state	60062	64232	UINT8 / LIST	R	<i>FdrE</i>	FDR state	
					<i>idle</i>	NOT ACTIVE	0 = Idle
					<i>init</i>	INIT	1 = Initialization
					<i>conf</i>	CONF	2 = Configuration
					<i>rdy</i>	RDY	3 = Ready
					<i>get</i>	GET	4 = Downloading the current configuration
					<i>set</i>	SET	5 = Saving the current configuration
					<i>app</i>	APP	6 = Writing the FDR server configuration to the drive
					<i>ope</i>	OPE	7 = Operational
					<i>ucfg</i>	UCFG	8 = Not configured
Ethernet fault code	60063	64233	UINT8 / LIST	R	<i>Fdrd</i>	FDR fault	See (1)
							0 = No fault
							2 = The FDR configuration file is not compatible with the drive type (example: the drive is not the correct rating)
							3 = Error reading the FDR configuration file on the server
							4 = Error writing the FDR configuration file to the server
							7 = Time out for receipt of the FDR configuration file from the server
							12 = The FDR configuration file is missing
							13 = Copy served->stored
							14 = File has invalid data
Periodic saving of the FDR service	60064	64230	UINT8 / LIST	R/W-NV	<i>FdrE</i>	FDR autosave	Default value : 0
					<i>no</i>	No	0 = Disable
					<i>yes</i>	Yes	1 = Enable
Interval for the FDR autosave service	60065	64231	UINT16	R/W-NV	<i>FdrE</i>	FDR t.autosave.	Default value: 10 Unit : 1 min
							0, 2-9999
Number of FDR save operations	60066		UINT16	R/W	<i>FdSc</i>		
							0-65535
Number of FDR restore operations	60067		UINT16	R/W	<i>FdrE</i>		
							0-65535
Number of FDR deletions	60068		UINT16	R/W	<i>FdDc</i>		
							0-65535
Statistics							
Number of active TCP connections	60044		UINT16	R			8 maximum
Received Modbus TCP message counter	60034		UINT32	R			IO Scanning messages not included
Sent Modbus TCP message counter	60032		UINT32	R			IO Scanning messages not included
Modbus TCP message error counter	60120		UINT32	R			IO Scanning messages not included
Received IO Scanning message counter	60039		UINT32	R			
Sent IO Scanning message counter	60037		UINT32	R			
IO Scanning message error counter	60041		UINT32	R			
	60111		UINT16	R			Bit 0 = Ethernet II
							Bit 1 = IEEE 802.3 sender Bit 2 = IEEE 802.3 receiver

Description	OptMb (Option)	AdL (Drive)	Type	R/W-NV	Short label	Long Label	Range list values
	MB Address	MB Address		access	HMI Name	Graphic Keypad Name	Comments / Units Valid values
OK reception counter	60024	—	UINT32	R	—	—	—
OK transmission counter	60019	—	UINT32	R	—	—	—
CRC error counter	60026	—	UINT32	R	—	—	—
Collision counter	60118	—	UINT32	R	—	—	—
Carrier sense errors counter	60122	—	UINT32	R	—	—	—
Excessive collisions counter	60116	—	UINT32	R	—	—	—
Late collision counter	60022	—	UINT32	R	—	—	—
Link status: right port.	60113	—	UINT16	R	—	—	—
			—		—	—	Bit 0: (Speed) 0 = 10Mbps 1 = 100Mbps Bit 1 & 2: (Cable type) 00 = T 01 = FL 10 = FX Bit 3 & 4: (duplex mode) 00 = half duplex 01 = full duplex 11 & 10 = unknown Bit 5: (state) 0 = link down 1 = link up
Link status: left port	60114		UINT16	R			Same as link status for right port

(1) This parameter is used to ascertain the cause of the interruption. The fault code remains saved.

Legend:

- R: Read only
- R/W: Read and Write access
- NV: Value is stored in non-volatile memory

Note: Parameters on 2 words are double words (low order in address word n, high order in address word n+1). The EEPROM IP addresses (60006 60017) are the ones set by the user, The current IP addresses (60075 60086) are the actual value.

Identification

Id	Value	Comment
16#00	"Schneider electric"	-
16#01	--	-
16#02	"0201"	-
16#04	"ALTIVAR 320"	Drive family
16#05	"ATV-XXXXX"	Drive commercial reference
16#06	"North elevator"	Device Name
16#07	--	-
16#08	2#00000000_00001011	-
16#09	--	-
16#0A	--	-
16#0B	--	-
16#0C	--	-

I/O Scanning Service

The I/O scanning service is used to exchange periodic I/O data between:

- A controller or PLC (I/O scanner).
- Devices (I/O scanning servers).

This service is activated with **[Eth IO scan act]** (**i o s a**) parameter ((**i o s a**) = **o f f** by default).

This exchange is usually performed by implicit services, thus avoiding the need to program the controller (PLC).

The I/O scanner periodically generates the Read/Write Multiple Registers (23 = 16#17) request. The I/O scanning service operates if it has been enabled in the PLC and the drive. The drive parameters assigned to I/O scanning have been selected by default. This assignment can be modified by configuration.

The drive I/O scanning service can also be configured by the Ethernet card Modbus server.

When the I/O scanning service has been enabled in the Altivar 320 drive:

- A TCP connection is assigned to it.
- The parameters assigned in the periodic variables are exchanged cyclically between the Ethernet card and the drive.
- The parameters assigned to the periodic output variables are reserved for I/O scanning. They cannot be written by other Modbus services, even if the I/O scanner is not sending its periodic output variables.

I/O Scanner Setting

The communication scanner is accessible via the following menus: **[Communication]** (**c o m -**) and **[Communication module]** (**c b d**) submenus.

The 6 output variables and the 6 input variables are assigned by means of parameters (**o c r 1**) to (**o c r 6**) and (**o n r 1**) to (**o n r 6**). An (**o c r x**) or (**o n r x**) parameter with a value of zero is not linked to a parameter in the drive.

These 6 parameters are described in the table below.

(**o c r x**) or (**o n r x**) defines the addresses.

[Scan.Out1 address]	(o c r 1)	(c n d)
[Scan.Out2 address]	(o c r 2)	(L F r d)
[Scan.Out3 address]	(o c r 3)	0
[Scan.Out4 address]	(o c r 4)	0
[Scan.Out5 address]	(o c r 5)	0
[Scan.Out6 address]	(o c r 6)	0
[Scan.IN1 address]	(o n r 1)	(E t r)
[Scan.IN2 address]	(o n r 2)	(r F r d)
[Scan.IN3 address]	(o n r 3)	0
[Scan.IN4 address]	(o n r 4)	0
[Scan.IN5 address]	(o n r 5)	0
[Scan.IN6 address]	(o n r 6)	0

Application Profile with Modbus TCP

The profiles managed with the ATV320 when it is controlled through Modbus TCP are:

- native profile (CiA402 - IEC 61800-7),
- I/O profile.

Please refer to “CiA@402 - IEC61800-7 Functional Profile” on page 79.

Configuring Communication Detected Fault Management

The response of the drive in the event of an Ethernet communication detected fault can be configured. It can be configured via the graphic display terminal or the integrated display terminal from the **[Monitoring] (FL E-)** menu, **[Fieldbus MONITORING] (CL L-)** submenu, via the **[Fieldbus interrupt resp] (CL L)** parameter.

RDY	NET	+0.00Hz	0A
Fieldbus MONITORING			<input type="checkbox"/>
Fieldbus interrupt resp :	Freewheel		
CANopen fault mgt :	Freewheel		
Modbus fault mgt :	Freewheel		
Code		Quick	<input type="checkbox"/>

The values of the **[Fieldbus interrupt resp] (CL L)** parameter, which trigger a drive detected fault **[Fieldbus Com Interrupt] (C n F)**, are:

Value	Meaning
[Freewheel] (Y E S)	Freewheel stop (factory setting)
[Ramp stop] (r n P)	Stop on ramp
[Fast stop] (F S E)	Fast stop
[DC injection] (d C i)	DC injection stop

The values of the **[Fieldbus interrupt resp] (CL L)** parameter, which do not trigger a drive detected fault, are:

Value	Meaning
[Ignore] (n a)	Detected fault ignored
[Per STT] (S E E)	Stop according to configuration of [Type of stop] (S E E)
[fallback spd] (L F F)	Change to fallback speed, maintained as long as the detected fault persists and the run command has not been removed
[Spd maint.] (r L S)	The drive maintains the speed at the time the detected fault occurred, as long as the detected fault persists and the run command has not been removed

The fallback speed can be configured in the **[Monitoring] (FL E-)** menu using the **[Fallback speed] (L F F)** parameter.

▲ WARNING

LOSS OF CONTROL

If this parameter is set to **n a**, fieldbus communication monitoring is disabled.

- Only use this setting after a thorough risk assessment in compliance with all regulations and standards that apply to the device and to the application.
- Only use this setting for tests during commissioning.
- Verify that communication monitoring has been re-enabled before completing the commissioning procedure and performing the final commissioning test.

Failure to follow these instructions can result in death, serious injury, or equipment damage.

CnF and ILF Detected Faults

The following table lists the time-out parameters:

Parameter	Description	Possible Values	Terminal Display
[Fieldbus Com Interrupt] <i>(CNF)</i> (written to the device)	This detected fault is used to indicate that a network detected fault has occurred. When the detected fault occurs, the option position the CNF parameter to the value corresponding to the detected fault. When the detected fault has disappeared, the option writes the CNF parameter to 0	1: Modbus TCP timeout 10: Network overload 11: Loss of carrier 14: Ethernet/IP Scanner timeout 15: Ethernet/IP Idle Poll 16: Ethernet/IP forced EIP trip 17: Application I/O configuration detected error	[1] (1) [10] (1 0) [11] (1 1) [14] (1 4) [15] (1 5) [16] (1 6) [17] (1 7)
[InternCom Error1] <i>(ILF)</i>	This detected fault indicates a critical detected error and can be cleared. It needs a Power Off / Power On to remove the detected fault	13: FDR uncoverable detected error 18: EEPROM detected error 21: Internal detected error	[13] (1 3) [18] (1 8) [21] (2 1)
[Fieldbus Error] <i>(EPF2)</i>		8: No valid IP 9: Duplicate IP address 12: FRD unconfigured detected error 13: FDR uncoverable detected error 20: invalid drive config when activating ODVA profile.	[8] (8) [9] (9) [12] (1 2) [13] (1 3) [20] (2 0)

Configuring Monitor Parameters

It is possible to select up to 4 parameters to display their values in the **[1.2 DISPLAY]** menu on the graphic display terminal (to be ordered separately - reference VW3A1101).

The selection is made via the **[3.3 Display configuration]** menu, **[Com. map config.]** submenu.

Each parameter, in the range **[Word 1 add. select.] ... [Word 4 add. select.]**, can be used to select the parameter logic address. An address at zero is used to disable the function.

Example

In the example given here, the monitored words are:

- Parameter 1 = Motor current (**L C r**): logic address 3204, signed decimal format.
- Parameter 2 = Motor torque (**a t r**): logic address 3205, signed decimal format.
- Parameter 3 = Last detected fault occurred (**L F t**): logic address 7121, hexadecimal format.
- Disabled parameter: Address W0; default format: Hexadecimal format

RDY	NET	+0.00Hz	0A
Com. map config..			
Word 1 add. select.	:		3204
Format word 1	:		Signed
Word 2 add. select.	:		3205
Format word 2	:		Signed
Word 3 add. select.	:		7121
Code		Quick	<input checked="" type="checkbox"/>

One of the three display formats below can be assigned to each monitored word:

Format	Range	Terminal display
Hexadecimal	0000 ... FFFF	[Hex] (HEX)
Signed decimal	-32 767 ... 32 767	[Signed] (5 r)
Unsigned decimal	0 ... 65 535	[Unsigned] (n 5 r)

NOTE: If a monitored parameter:

- Has been assigned to an unknown address (example: 3200).
- Has been assigned to a protected parameter.
- Has not been assigned.

the value displayed in the **[Communication map]** screen will be: "••••" (see "CnF and ILF Detected Faults" on page 50).

Controlling an ATV320 From Modbus TCP (M340)



8

What's in this Chapter?

This chapter contains the following topics:

Topic	Page
Description of the Configuration	53
Configuration of the Ethernet Module (NOE 100 or NOE 110)	55
Monitor and Control the Exchanges	58
Modbus Messaging	59

Description of the Configuration

The configuration is made of an ATV320 and a M340 with a NOE110 (or NOE100) Ethernet module.
 The devices are configured with the (fixed) following IP addresses as follows:

IP: 10.0.0.11

IP: 10.0.0.10

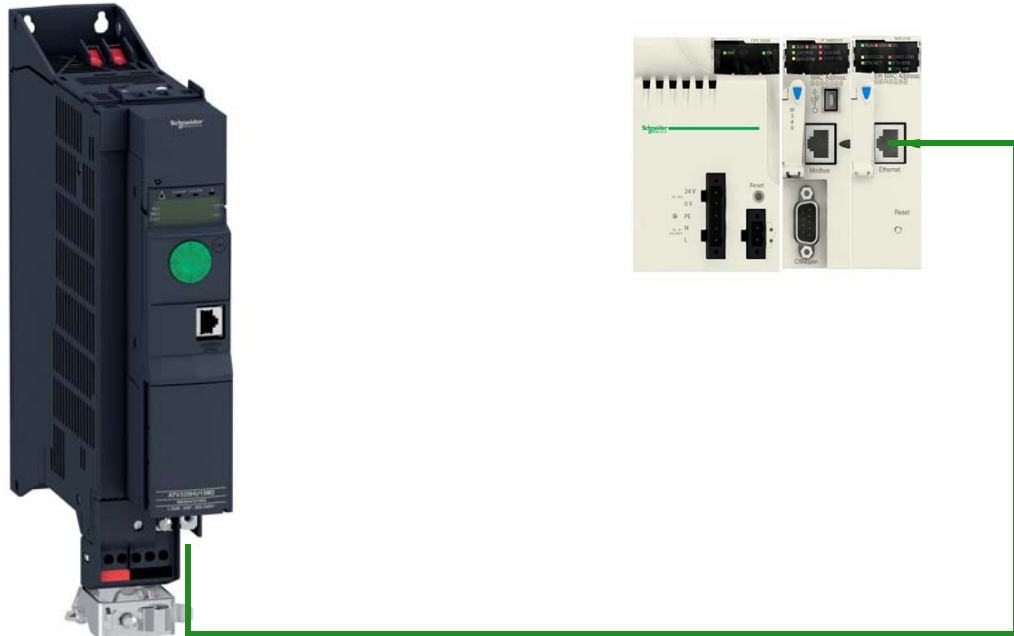

The ATV320 will be controlled through the option communication scanner by means of the I/O scanning service.

It is important to notice that the implicit exchanges are based on the VW3A3616 internal communication scanner and not on the ATV320 internal scanner. The first one is reachable by using the unit ID 255, while the second one is reachable with the Unit ID 0:

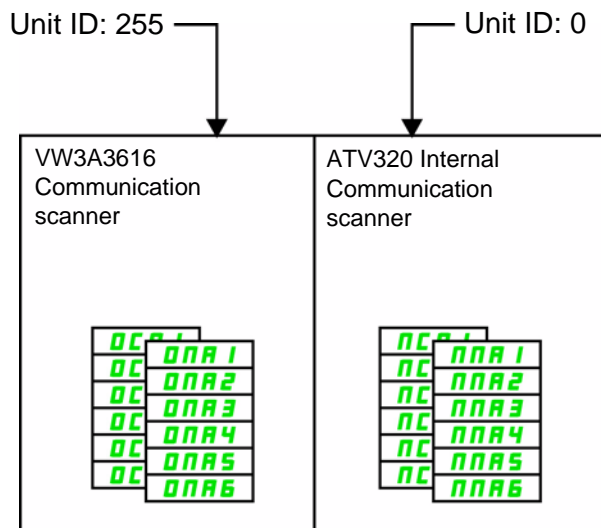

The option Com scanner parameters start with (ONCAX) and (ONPAX) and are part of the communication card submenu (instead of (ONCAX), (ONPAX) for the drive which are directly located in the Communication main menu). The usage of the (ONCAX), (ONPAX) with (via Unit ID 0) is not recommended.

Configuration of the VW3A3616 Communication Card

Conf > Full > Communication > Communication card

ETHM = MBTP		Defines the protocol used: Modbus TCP
IPM = MANU		IP address is defined locally
IP card = 10.0.0.11		-
IP Mask 255.0.0.0		-
IP Master = 10.0.0.10		Defines the address of the I/O scanner client (M340 Ethernet module)
OCA1	8501 > CMD	In the example we will use the default parameters + an additional parameter for monitoring
OCA2	8602 > LFRD	
OCA3	-	
OCA4	-	
OCA5	-	
OCA6	-	
OMA1	3201 > ETA	
OMA2	8604 > RFRD	
OMA3	3207 > ULN	
OMA4	-	
OMA5	-	
OMA6	-	

Configuration of the Command

In the Command Menu **[Command]** (C E L):

- **[Ref Freq 1 Config]** (F r I): is set according to the communication source you can choose in the following table:

Origin of the control	Ref1 Channel setting
Modbus TCP	[Com. Module] (r E E)

- **[Reverse Disable]** (r i n): default.
- **[Stop Key enable]** (P S E): default.
- **[Control Mode]** (C H C F): defines if the drives operates in combined mode (reference and command from the same channel)

For the current example, **[Control Mode]** (C H C F) will be adjusted to **[Not Separ.]** (S i n) as reference and control are originated from the communication network:

Profile	Ref1 Channel setting
CiA402	[Not Separ.] (S i n)
Separate	[Separate] (S E P)
I/O Profile	[I/O Profile] (i o)

Configuration of the Ethernet Module (NOE 100 or NOE 110)

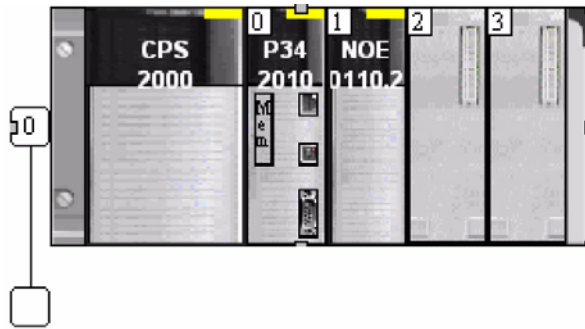

Create a new logical network in the section:



Configuration of the IP Settings

Model Family NOE 0100.2, NOE 0110.2		Module Address Rack: 0 Module: 1 Channel: 0		Module Utilities YES ID Scanning NO Global Data NO Address Server NO NTP	
Module IP Address IP Address: 10 . 0 . 0 . 10 Subnetwork Mask: 255 . 255 . 255 . 0 Gateway Address: 0 . 0 . 0 . 0					
IP Configuration Messaging IO Scanning Global Data SNMP Address Server NTP Bandwidth					
IP address configuration <input checked="" type="radio"/> Configured IP address: 10 . 0 . 0 . 10 Subnetwork mask: 255 . 0 . 0 . 0 Gateway address: 0 . 0 . 0 . 0 <input type="radio"/> From a server Device Name: _____					
Ethernet configuration <input checked="" type="radio"/> Ethernet II <input type="radio"/> 802.3					

Enable Messaging With the ATV320

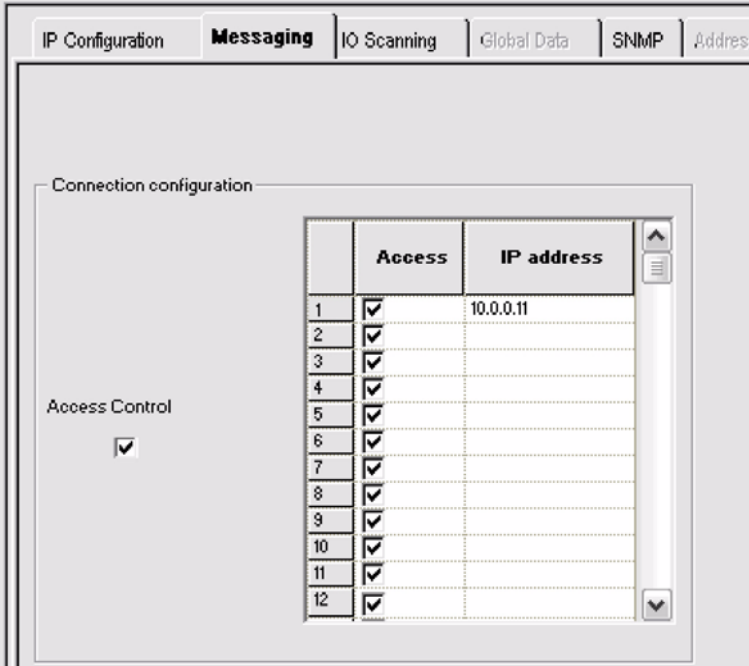

Configure I/O Scanning With the ATV320

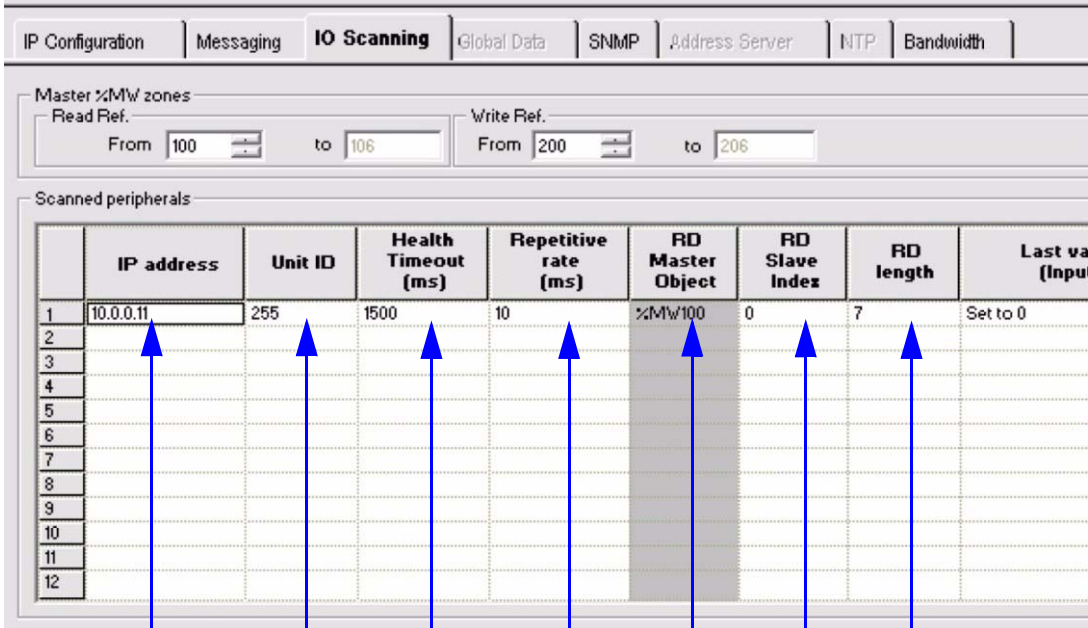

ATV IP address
 Unit ID: 255 (option card)
 Time out for monitoring
 Period: here 10 ms
 1st address of the %MW for the read data (ATV > M340)
 1st address of the %MW for the read data (ATV > M340)
 Length: 7

NOTE: The length of the communication is 6 words, but the first word of the I/O scanning service is reserved. In practice, (o P R I) will be linked to %MW101 and (o C R I) will be linked to %MW201.

1st address of the %MW for the written data (M340 > ATV) is shown below:

Unit ID	Health Timeout (ms)	Repetitive rate (ms)	RD Master Object	RD Slave Index	RD length	Last value (Input)	VR Master Object	VR Slave Index	VR length	Description
255	1500	10	%Mw100	0	7	Set to 0	%Mw200	0	7	

Default values if I/O scanning is stopped or detect a fault.

1st address of the %MW for the written data (M340 > ATV)

1st address of the %MW for the read data (M340 > ATV)

Length: 7

NOTE: The length of the communication is 6 words, but the first word of the I/O scanning service is reserved. In practice, (□□□□□□) will be linked %MW101 and (□□□□□□) will be linked to %MW201.

Start and Check the Exchanges

Once the project is

built, it can be downloaded to the PLC and then launched. The exchanges (implicit) should start immediately:

Name	Value	Type	Comment
%Mw101	16#0233	INT	
%Mw102	0	INT	
%Mw103	2312	INT	
%Mw104	16#0000	INT	
%Mw105	16#0000	INT	
%Mw106	0	INT	
%Mw201	16#0007	INT	
%Mw202	-641	INT	
%Mw203	0	INT	
%Mw204	0	INT	
%Mw205	0	INT	
%Mw206	0	INT	

Monitor and Control the Exchanges

The communication can be monitored with several I/O objects.

In the example below, the I/O objects have been prefixed EthStatus.

You can check EthStatus.MOD_ERROR (will be equal to 1 if one or more exchanges are unsuccessful).

I/O Scanning

The array %IW0.1.0.1:4 displays the status of the overall active I/O scanning Client/server. This table is graphically animated in the debug view of the Ethernet module:



Name	Value	Type	Comment
EthStatus		T_GEN_MOD	
MOD_ERROR	0	BOOL	Module error
EXCH_STS	0	INT	Exchange status
STS_IN_PROGR	0	BOOL	Status parameter read in progress
EXCH_RPT	0	INT	Channel report
STS_ERR	0	BOOL	Error while reading module status
MOD_FLT	0	INT	Module faults
MOD_FAIL	0	BOOL	Internal fault: Module failure
CH_FLT	0	BOOL	Faulty channel(s)
BLK	0	BOOL	External fault: Terminal block
CONF_FLT	0	BOOL	Hardware or software configuration fault
NO_MOD	0	BOOL	Module absent or powered-down
EXT_MOD_FLT	0	BOOL	FIPIO extension module fault
MOD_FAIL_EXT	0	BOOL	Internal fault: Module failure (only FIPIO extension)
CH_FLT_EXT	0	BOOL	Faulty channel(s) (only FIPIO extension)
BLK_EXT	0	BOOL	External fault: Terminal block (only FIPIO extension)
CONF_FLT_EXT	0	BOOL	Hardware or software configuration fault (only FIPIO extension)
NO_MOD_EXT	0	BOOL	Module absent or powered-down (only FIPIO extension)
%IW0.1.0.0	2#1111_1111_1111_1100	INT	
%IW0.1.0.1	2#0000_0000_0000_0001	INT	
%QW0.1.0.0	0	BOOL	

The exchanges can be stopped by setting to 1 the pending bit in the array %QW0.1.0.0 (in the example).

Modbus Messaging

Access to the drive parameters is also available by means of the Modbus read / write functions. With the M340, this feature is achieved with the functions READ_VAR, WRITE_VAR.

Example with READ_VAR:

```
if not ReadVarbusy then
  READ_VAR( ADDM ('0.1.0{10.0.0.11}0'), '%MW' ,3603,2, ReadvarMGT, %MW124:4);
END_If;
```

READ_VAR address value:

3603	logic address of the 1st read word in the ATV320
2	Numbers of %MW
ReadvarMGT	1st word destination address
%MW124:4	Read_Var request status array
Readvarbusy	bit member of the array %MW124:4

The path to the device is obtained by the ADDM function with the following syntax:

0.1.0	Ethernet module
{10.0.0.11}	The IP address of the module
0: UnitID	Drive Unit ID (see "Modbus TCP Features" on page 41 for more details)

EtherNet/IP Features



9

What's in this Chapter?

This chapter contains the following topics:

Topic	Page
VW3A3616 and EtherNet/IP Overview	61
Cyclical Exchanges (Implicit Exchanges)	62
Messaging (Explicit Exchanges)	66
Detected Fault Management	67

VW3A3616 and EtherNet/IP Overview

EtherNet/IP Communication Card Features Overview

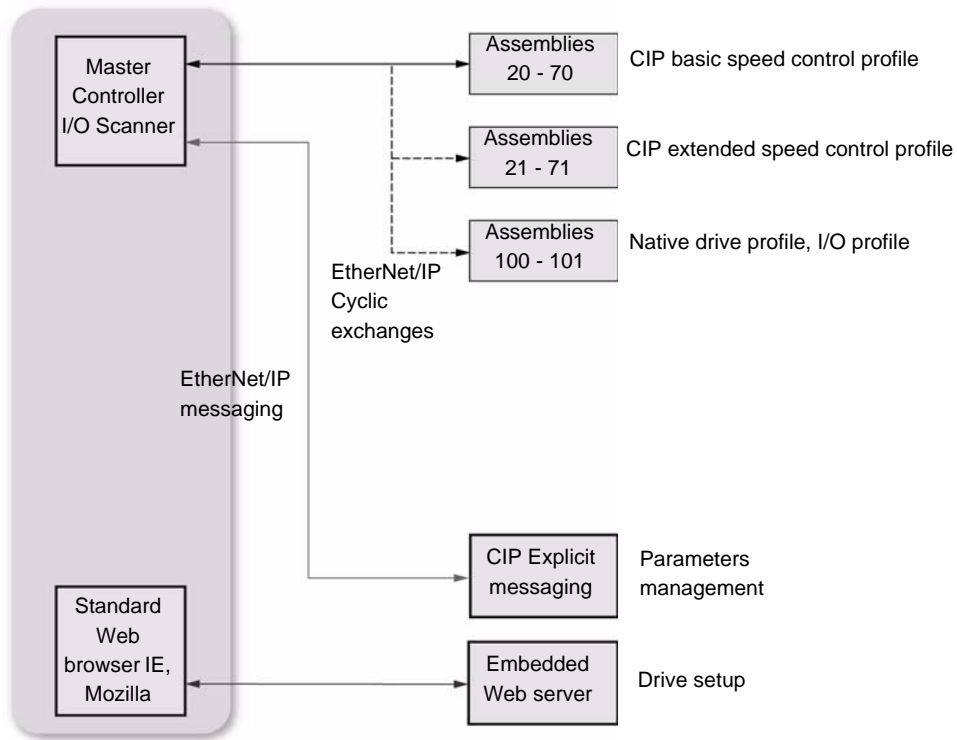

The Altivar 320, equipped with the VW3A3616, is compliant with the ODVA drive profile. It supports the 3 following profiles:

- CIP basic speed control
- CIP extended speed control
- ATV320 native profile (IEC 61800-7 CiA402) and I/O profile only for assembly 100 and 101.

In addition to these cyclic exchanges, the VW3A3616 also supports explicit messaging.

Cyclical Exchanges (Implicit Exchanges)

Overview

This part gives a description of the 3 assembly sets and how to configure them.

Principle of Control configuration

By the configuration of the control, it is possible to decide from what channel the drive receives its commands and setpoint, either permanently or depending on a switching command. Numerous configurations are possible. For more information, refer to the Programming manual and Communication parameters manual. The following configurations are some of the available possibilities.

The selection of the assembly set is made with the EtherNet/IP communication adapter.

Control With Communication Scanner

If the default assemblies (100, 101) are selected, the Altivar 320 will be controlled according to its native profile CiA402.-IEC-61800-7 (See "CiA@402 - IEC61800-7 Functional Profile" on page 79). By configuring the communication scanner, it is possible to assign any relevant parameter of the drive to the 6 input and 6 output variables of the assemblies.

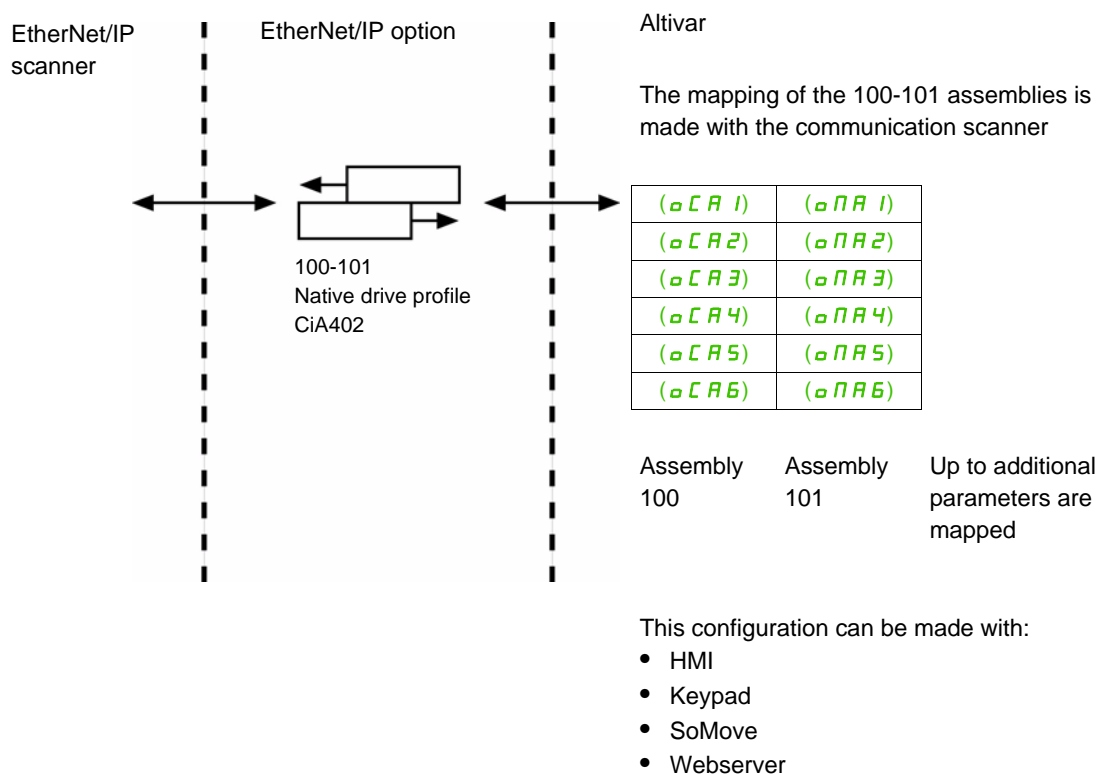

The size of the assembly (100, 101) is fixed and is equal to 6 words.

The mapping of the other parameters is made with the communication scanner.

The configuration of the addresses defined with (oC A x) and (oP A x) can be made with the graphic keypad:

- For assembly 100: **[Communication]** (C o P -) menu, **[Communication module]** (C b d -) submenu.
- For assembly 101: **[Communication]** (C o P -) menu, **[Communication module]** (C b d -) submenu.

See menu **[1.2 DISPLAY]** (P o n -) > COMMUNICATION MAP to monitor the communication scanner.

Assembly Set Selection With RS Logix - From Controller Side

Example of selection of the assemblies 100, 101 in the EtherNet/IP adapter configuration dialog box.

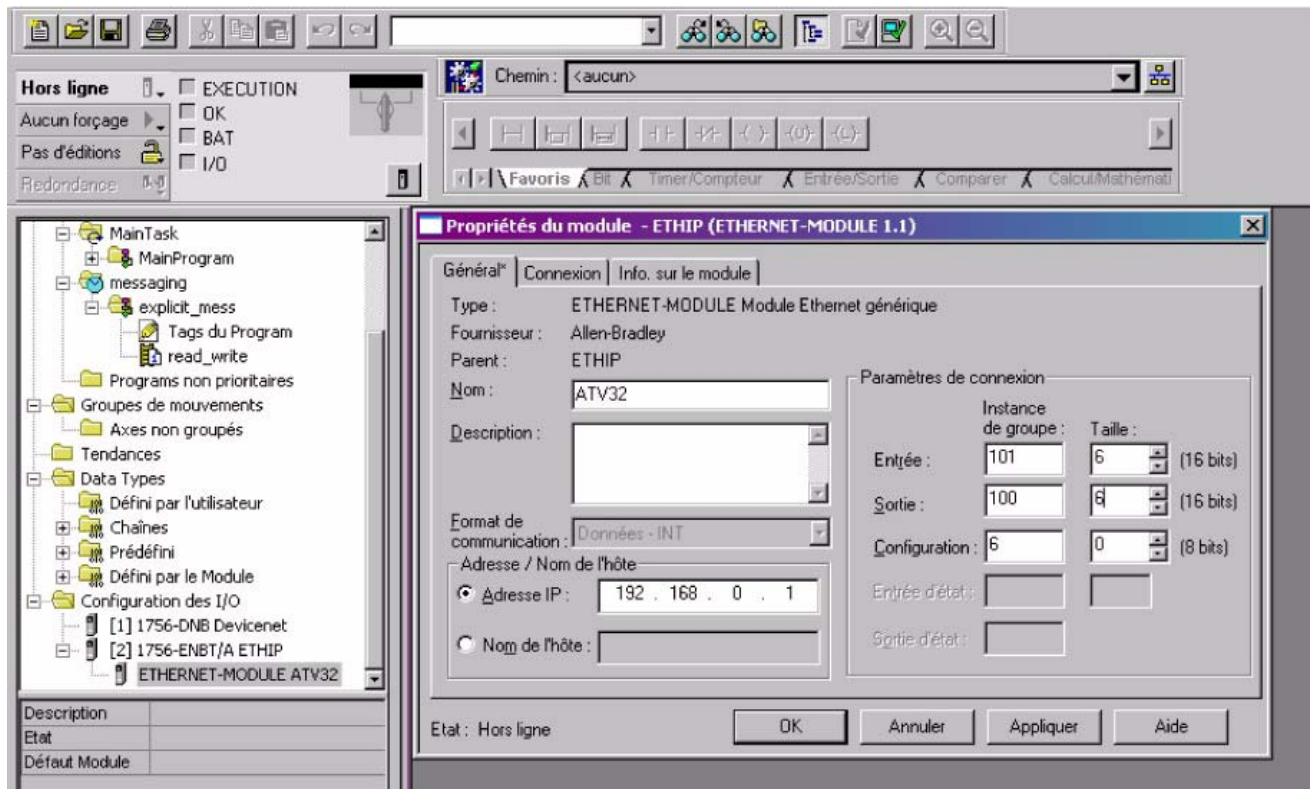

Control According to ODVA AC Drive Profile

The ODVA AC drive profile is activated when one of the following assemblies is selected:

- 20: Basic speed control output, size 2 words / 4 bytes
- 21: Extended speed control output, size 2 words / 4 bytes
- 70: Basic speed control input, size 2 words / 4 bytes
- 71: Extended speed control input, size 2 words / 4 bytes

The EtherNet/IP card translates the commands, behavior and monitoring information from of ODVA profile (on the network) to the CiA402 profile (in the drive).

CIP Basic Speed Control (Assemblies 20 and 70)

- Assembly 20: CIP basic speed control output

The following table describes the assembly mapping:

Word Number	Definition
0	CIP basic command word
1	Speed setpoint (rpm)

The following table describes the CIP basic command word:

Bit 7	Bit 6	Bit 5	Bit 4	Bit 3	Bit 2	Bit 1	Bit 0
Not used	Not used	Not used	Not used	Not used	Fault reset ⁽¹⁾ 0= No command 1= Fault reset	Not used	Run forward ⁽²⁾ 0= Stop 1= Run

(1) Active on rising edge

(2) Active on level

Bit 15	Bit 14	Bit 13	Bit 12	Bit 11	Bit 10	Bit 9	Bit 8
Not used	Not used	Not used	Not used	Not used	Not used	Not used	Not used

- Assembly 70: CIP basic speed control input

The following table describes the assembly mapping:

Word Number	Definition
0	CIP basic status word
1	Actual speed (rpm)

The following table describes the CIP basic status word:

Bit 7	Bit 6	Bit 5	Bit 4	Bit 3	Bit 2	Bit 1	Bit 0
Not used	Not used	Not used	Not used	Not used	Running 0= Stopped 1= Running	Not used	Faulted 0= No fault 1= Fault

Bit 15	Bit 14	Bit 13	Bit 12	Bit 11	Bit 10	Bit 9	Bit 8
Not used	Not used	Not used	Not used	Not used	Not used	Not used	Not used

CIP Extended Speed Control (Assemblies 21 and 71)

Note: «NetRef» and «NetCtrl» objects must be set by explicit messaging to control the drive by Network.

- Assembly 21: CIP extended speed control output

The following table describes the assembly mapping:

Word Number	Definition
0	CIP extended command word
1	Speed setpoint (rpm)

The following table describes the CIP extended command word:

Bit 7	Bit 6	Bit 5	Bit 4	Bit 3	Bit 2	Bit 1 Bit 0
Not used	Network setpoint 0 = Setpoint by terminals 1= Setpoint by network	Network command 0 = Setpoint by terminals 1= Setpoint by network	Not used	Not used	Fault reset ⁽¹⁾ 0= No command 1= Fault reset	Run forward / reverse 00= Quick stop 01= Run forward 10= Run reverse 11= No action

(1) Active on rising edge

Bit 15	Bit 14	Bit 13	Bit 12	Bit 11	Bit 10	Bit 9	Bit 8
Not used	Not used	Not used	Not used	Not used	Not used	Not used	Not used

Network setpoint and network address management

The assembly 21 uses the setpoint and reference switching of the Altivar 320. The VW3A3616, when configured with the assembly 21, links the bit 5 and the bit 6 to C312 and C313 respectively. To operate correctly, the Command settings of the ATV320 must be as follows:

Menu	Parameter	Permitted value
[Command] (CCL-)	[Control Mode] (CHF)	[Separate] (SEP)
[Application function] (Fun-)	[Ref Freq 1 Config] (Fr1)	[Com. Module] (nEE)
[Ref Freq switch] (REF-)	[Ref Freq 2 Config] (Fr2)	[AI1] (R,1) or [AI2] (R,2)
	[Cmd channel 1] (Cd1)	[Com. module] (nEE)
	[Cmd channel 2] (Cd2)	[Terminals] (EEr)
	[Command switching] (CC5)	[C312] (C312)
	[Freq switch Assign] (rFL)	[C313] (C313)

- Assembly 71: CIP extended speed control input

The following table describes the assembly mapping:

Word Number	Definition
0	CIP extended status word
1	Actual speed (rpm)

The following table describes the CIP extended status word:

Bit 7	Bit 6	Bit 5	Bit 4	Bit 3	Bit 2	Bit 1	Bit 0
At reference 0= Reference not reached 1= Reference reached	Setpoint from network 0= Setpoint from terminals 1= Setpoint from network	Command from network 0= Command from terminals 1= Command from network	Ready 0= Not ready 1= Ready	Run forward / reverse 00= Stopped 01= Running forward 10= Running reverse 11= Not used	Warning 0= No warning 1= Warning	Not used	

Bit 15	Bit 14	Bit 13	Bit 12	Bit 11	Bit 10	Bit 9	Bit 8
Not used	Not used	Not used	Not used	Not used	Bit 8 to 10 are used for the drive state 000= Not used 001= Startup 010= Not ready 011= Ready 100= Enabled 101= Stopping 110= Fault stop 111= Faulted		

Messaging (Explicit Exchanges)

Introduction

All the ATV320 parameters can be accessed by R/W as CIP objects.

Altivar Parameters Path

The Altivar parameters are grouped in classes:

- Each application class has only 1 instance.
- Each instance groups 200 parameters.
- Each attribute in an instance relates to a parameter.

The first parameter registered in the first application class (class code: 16#70 = 112) has the logical address 3000.

Examples

The following table describes the examples of logical addresses:

Logical Address	Path Hexadecimal	Path Decimal
3000	16#70 / 01 / 01	112 / 1 / 1
3100	16#70 / 01 / 65	112 / 1 / 101
3200	16#71 / 01 / 01	113 / 1 / 1
64318	16#A2 / 1 / 77	418 / 1 / 119

An example of explicit messaging is shown below. The value of the ACC parameter (Modbus @ = 9001 / CIP address 16#8E/01/02) is modified when the variable "bit01" is toggled ON.

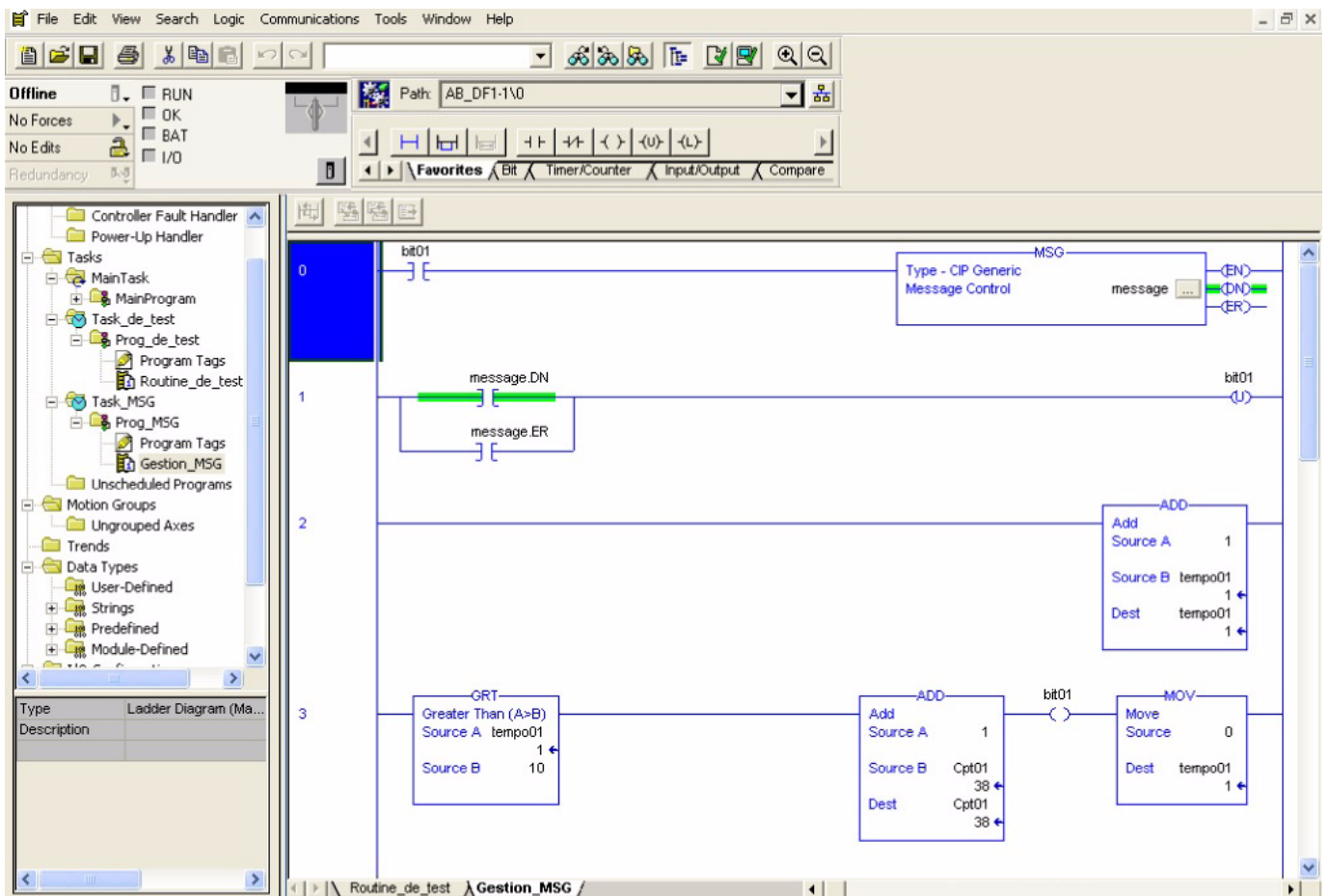

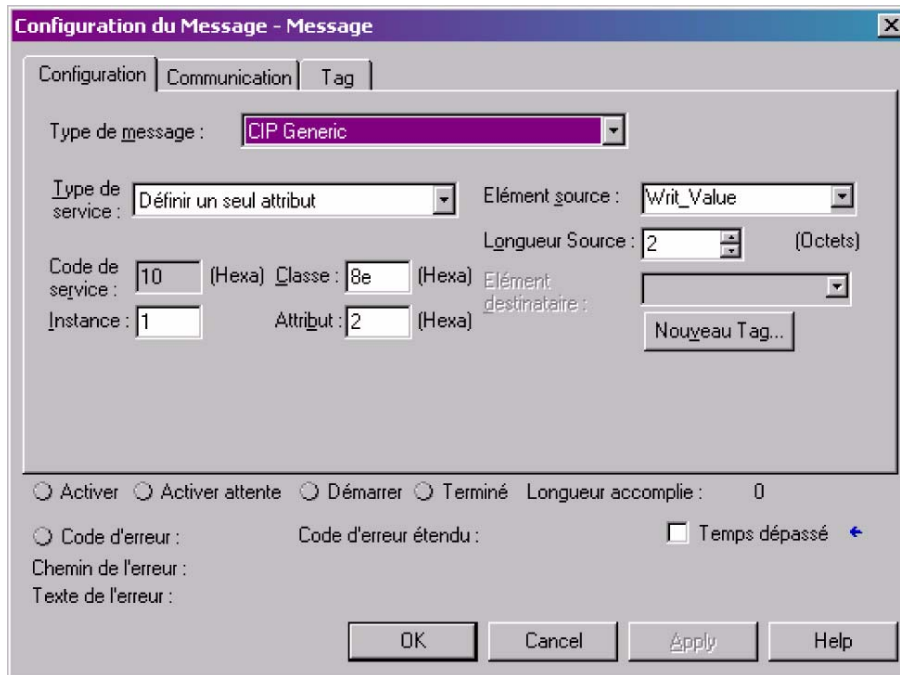

Detected Fault Management

An EtherNet/IP time out is triggered if the card does not receive any cyclic messages (within a predefined time period).

This period is managed by the EtherNet/IP controller (not by the drive) and is configured in its module properties box. The duration of the time out is defined by the RPI (Request packet intervals).

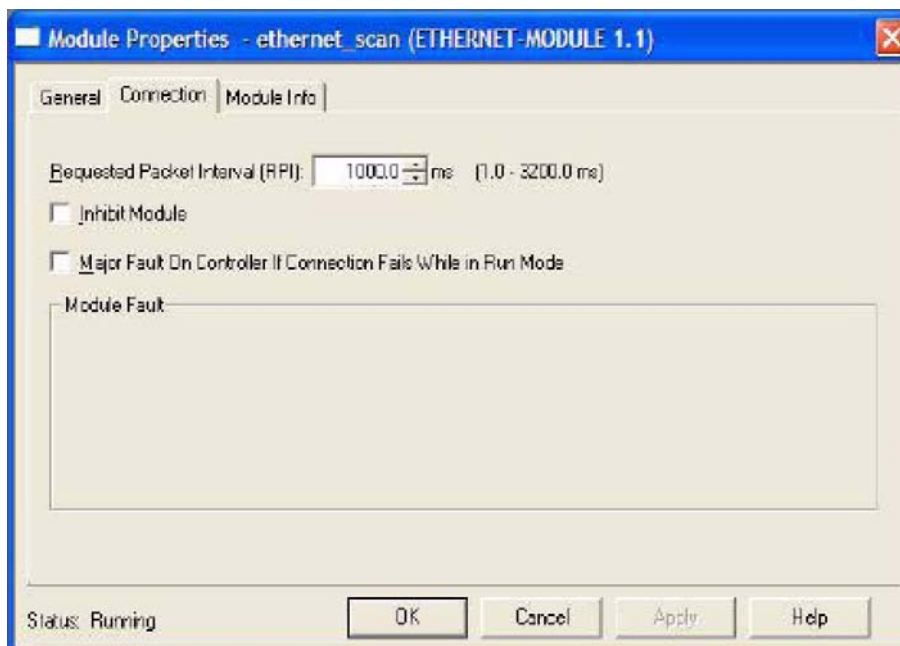

Configuration can be performed using the graphic display terminal or integrated display terminal using the **[Fieldbus interrupt resp]** (LLL) parameter in the **[Monitoring]** (FLE-) menu, **[Fieldbus MONITORING]** (LLL-) submenu.

ATV320 Configuration in ETC100

**10**

What's in this Chapter?

This chapter contains the following topics:

Topic	Page
Procedure	69
Explicit Messaging	74

Procedure

Create a New Project and Add the ETC100 Module

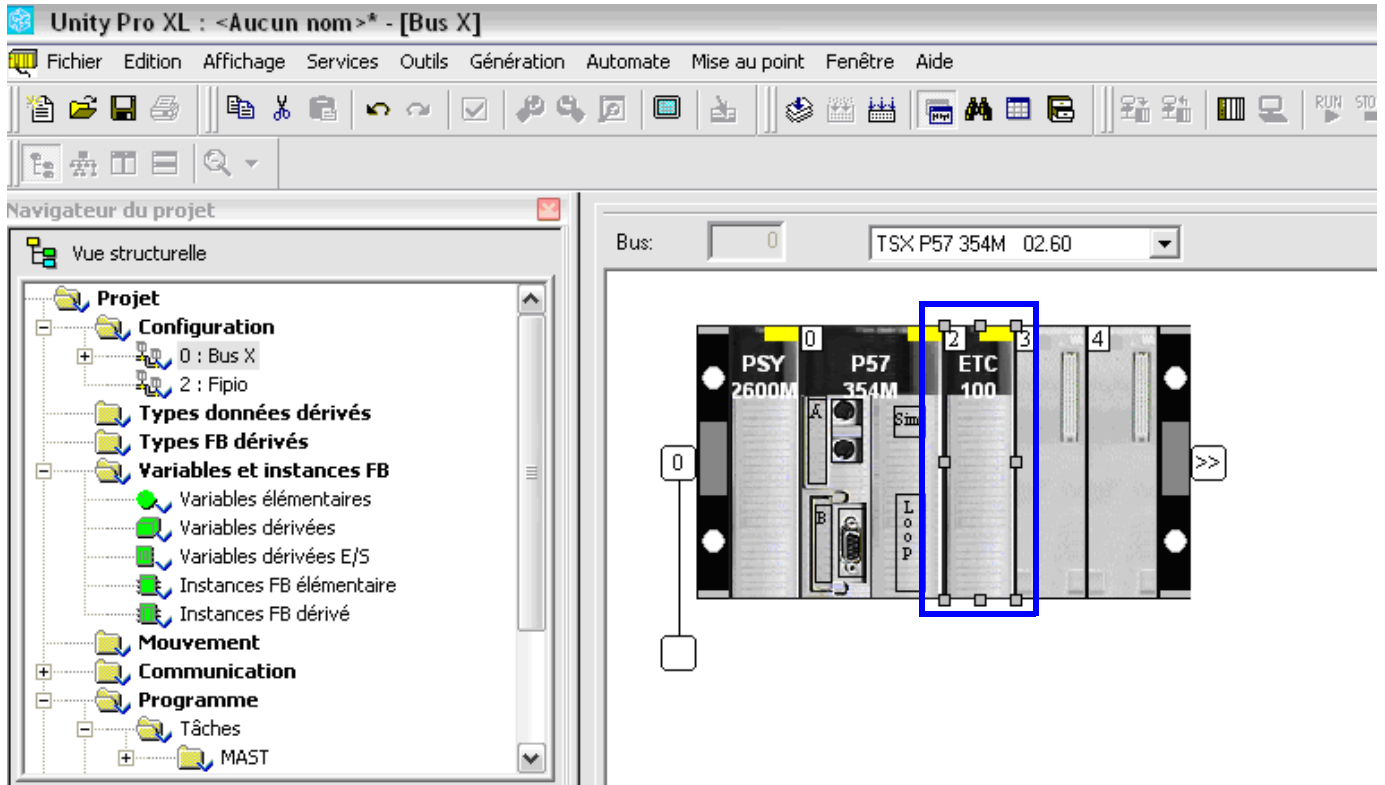

Open the ETC100 Module

- Choose the Network name (1)
- Choose the input and output size (2)
- Launch the Ethernet/IP configuration tool (3)

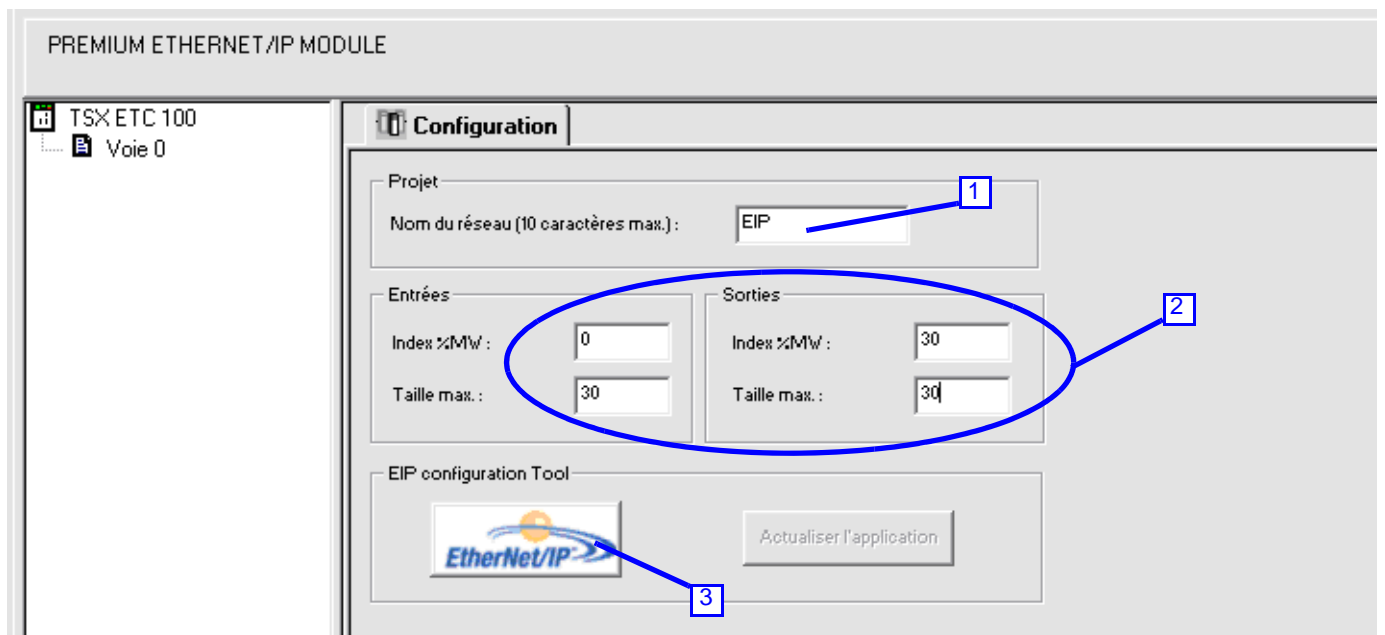

Define the ETC100 Network Parameter

- Double-click on ETC100 module (1)
- Configure ETC100 (2)
 - IP address
 - Mask
 - Gateway

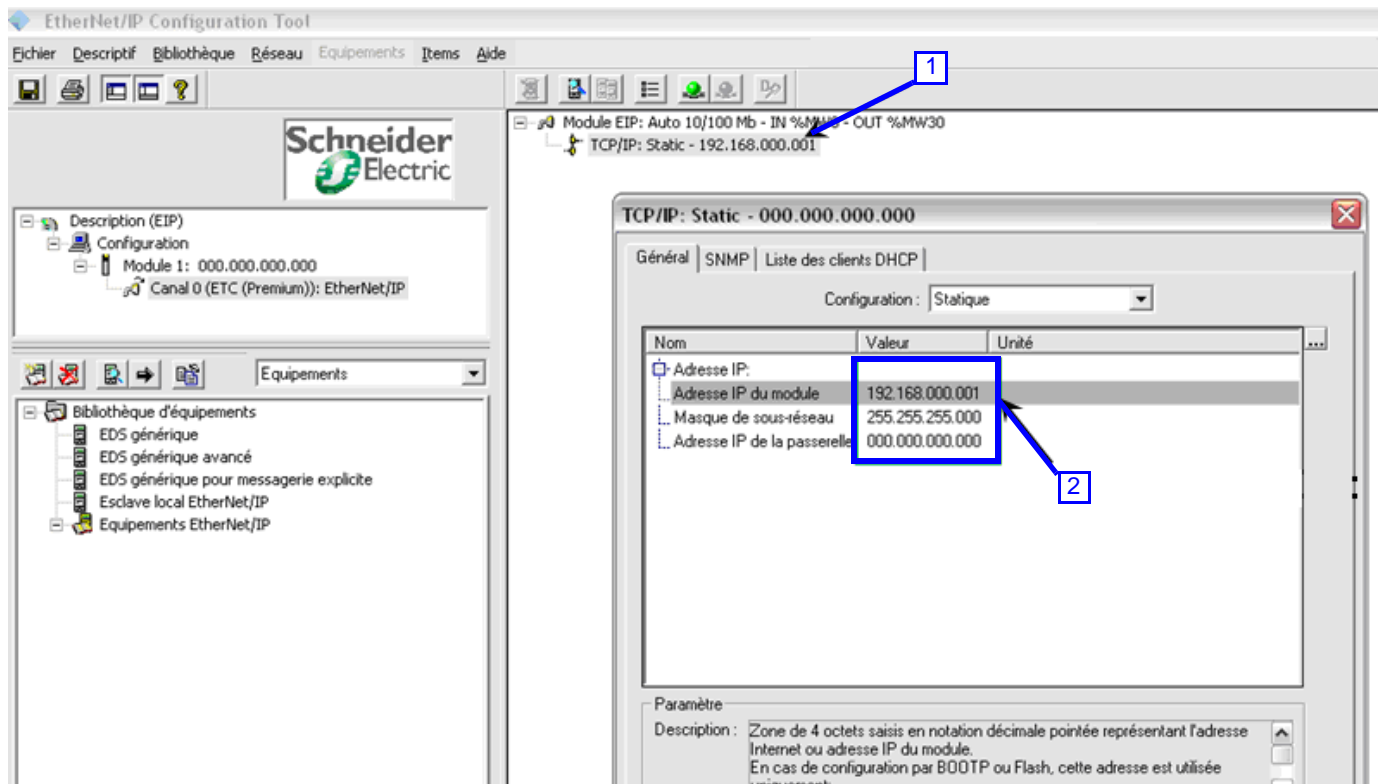

In EIP Configuration Tool, Insert the ATV320 EDS File

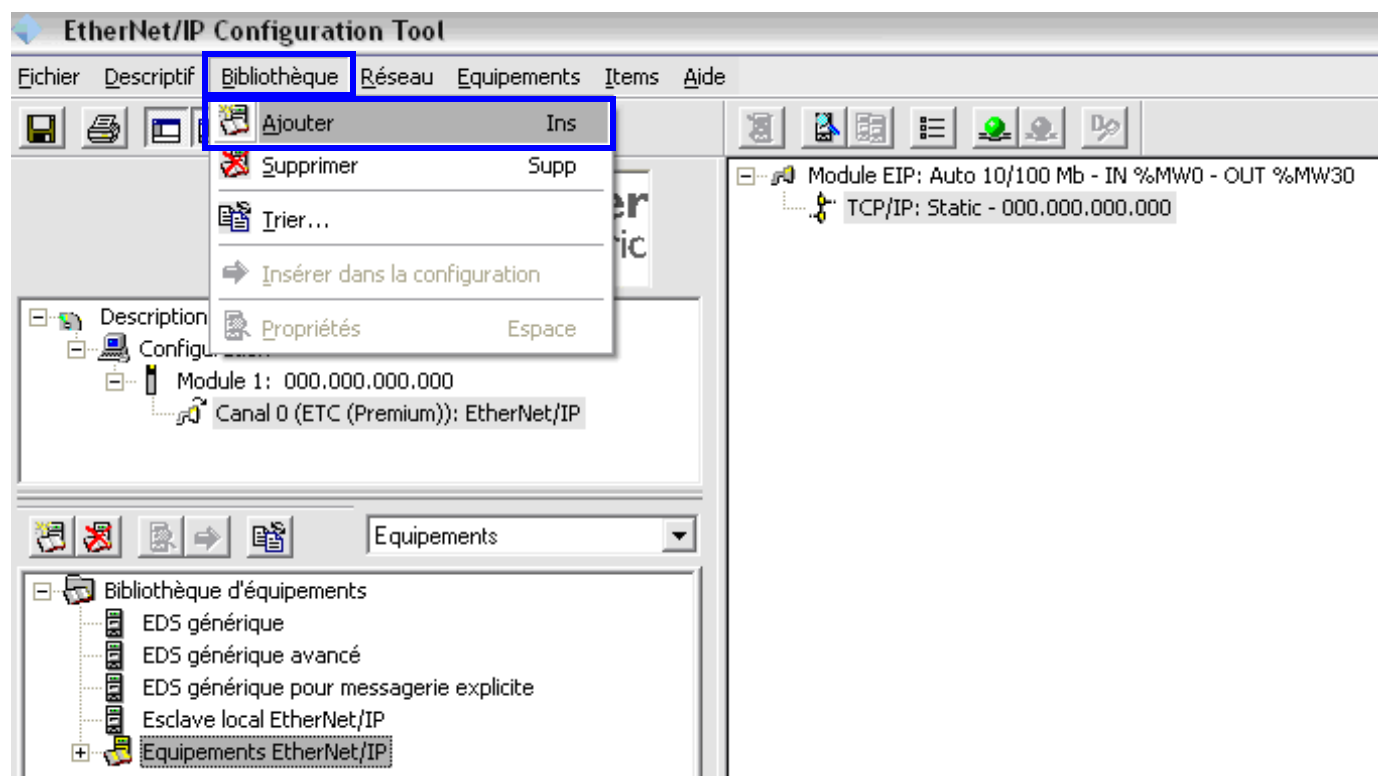

Follow the EIP configuration tool to add the ATV320 EDS file.

Add the ATV320

- Double-click on ATV320 (1)
- Choose a name (2)
- Select the device number (3)
- Select “link parameter” (4)
- Configure the ATV320 IP Address (5)

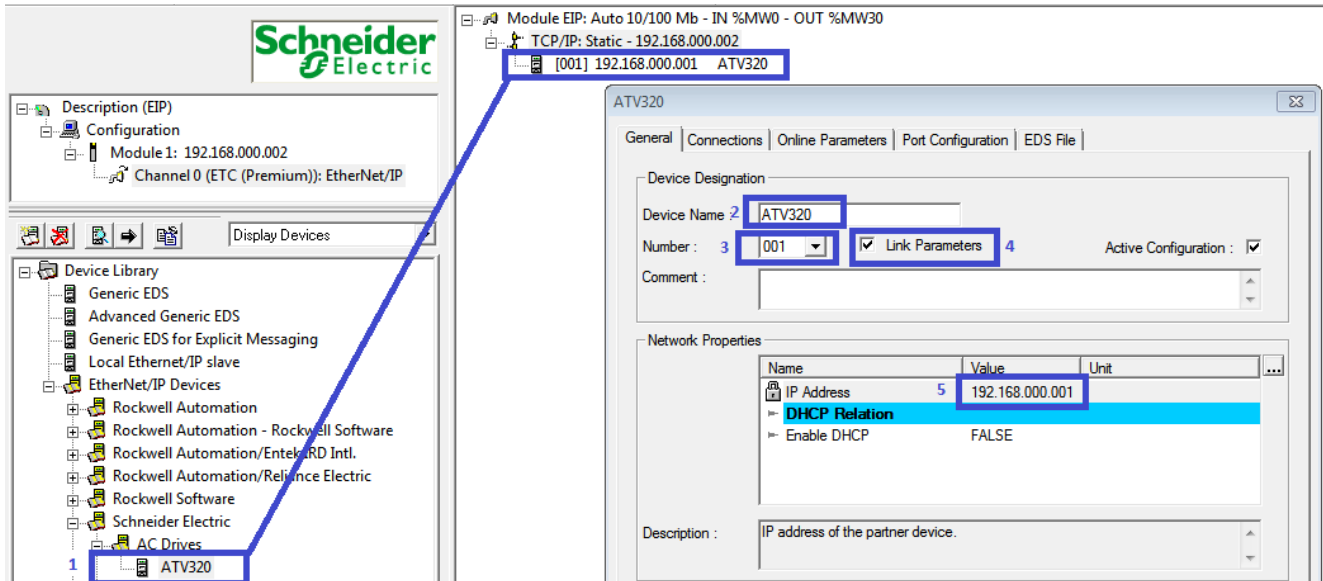

Assemblies Configuration

Here is a selection of Native drive control (Assembly 100-101):

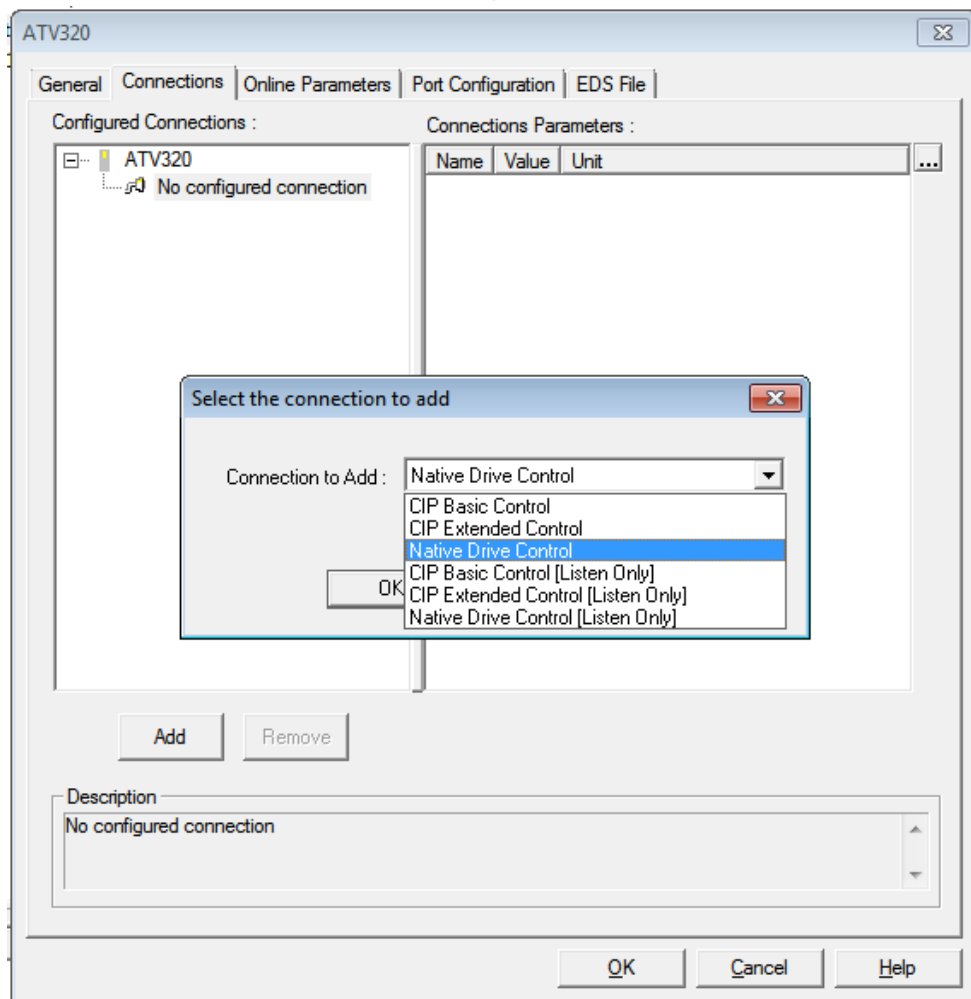

Item Configuration

This configuration pre-defines the input and output. This input and output can be used in UNITY.

- Double-click on assembly configured (1)
- Select all the items (2)
- Define the items (3)
- Choose "word" and click on OK (4)

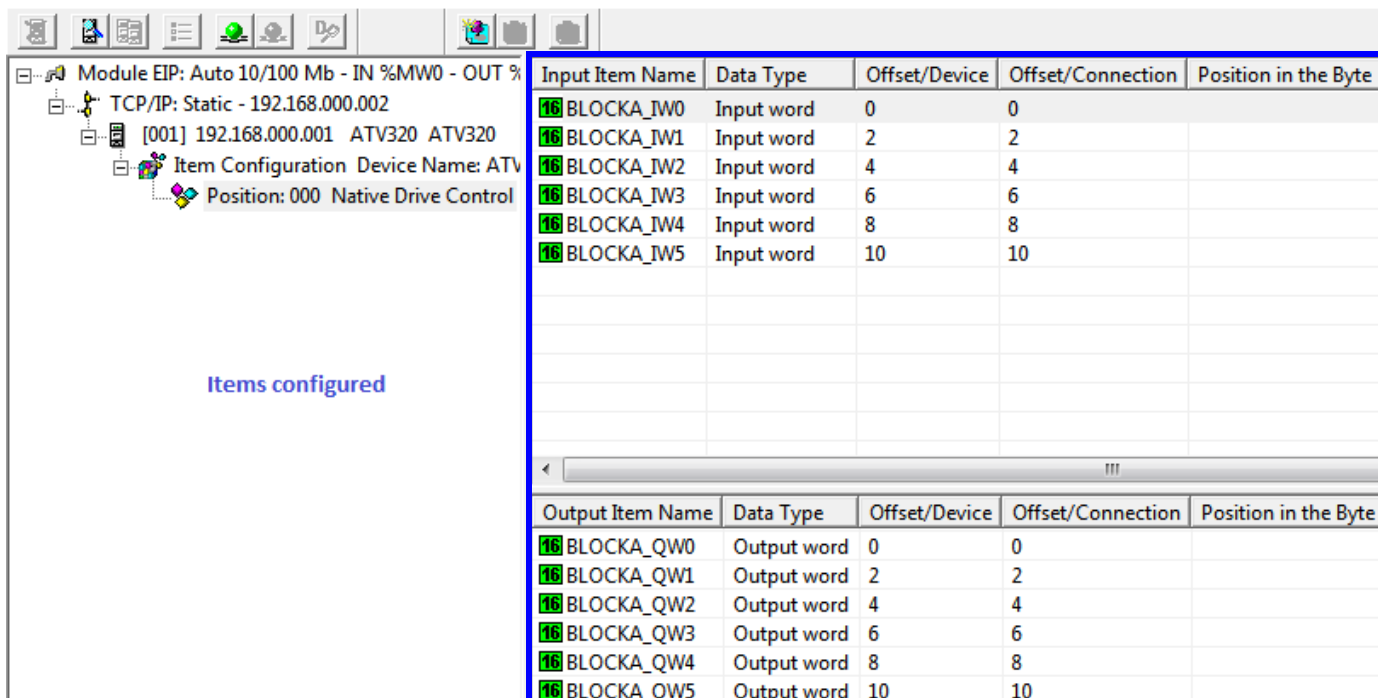
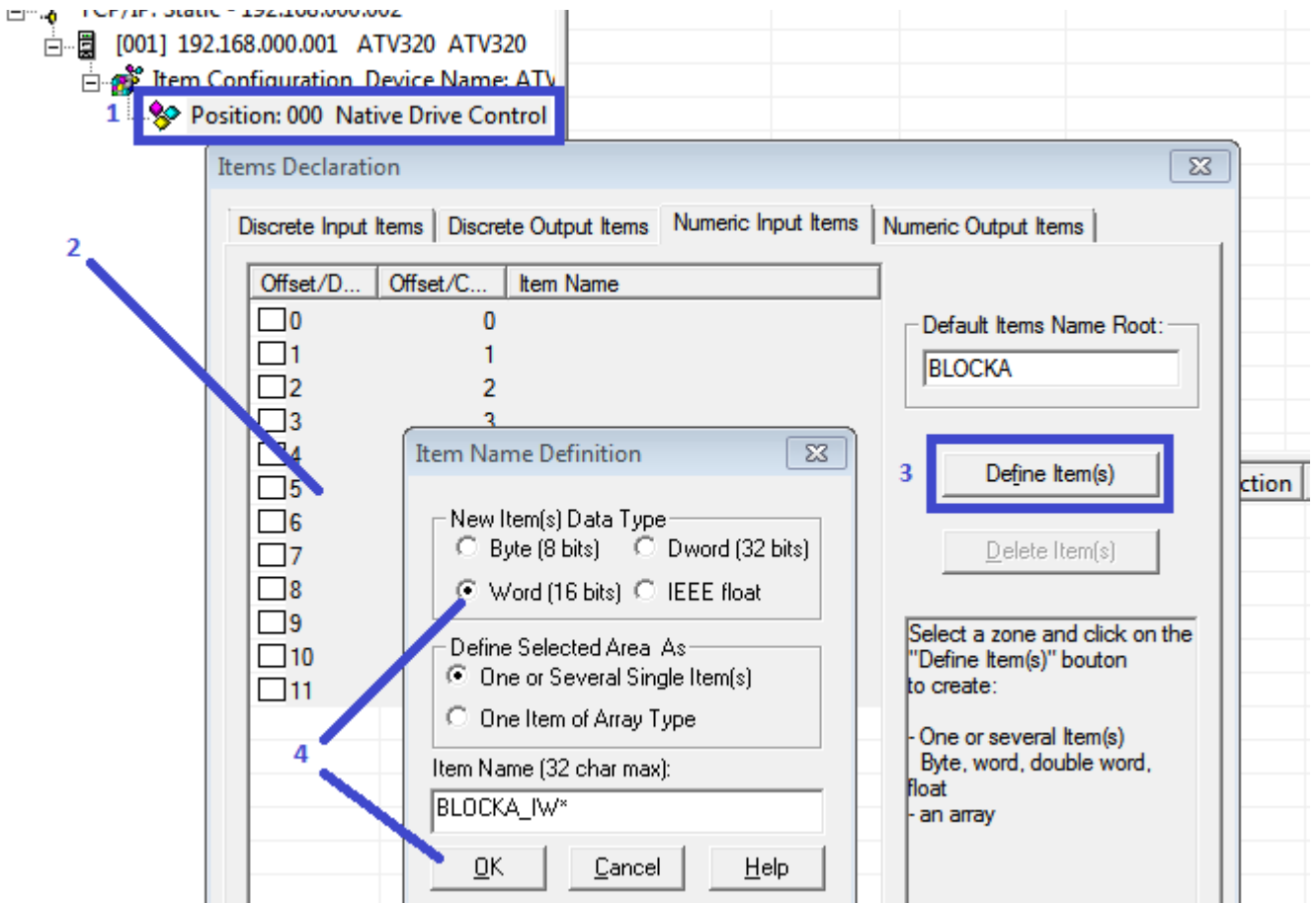

After this operation, you can save and close the EIP configuration tool.

Unity Update

When the configuration has been changed in the EIP configuration tool, it is necessary to update the UNITY configuration.

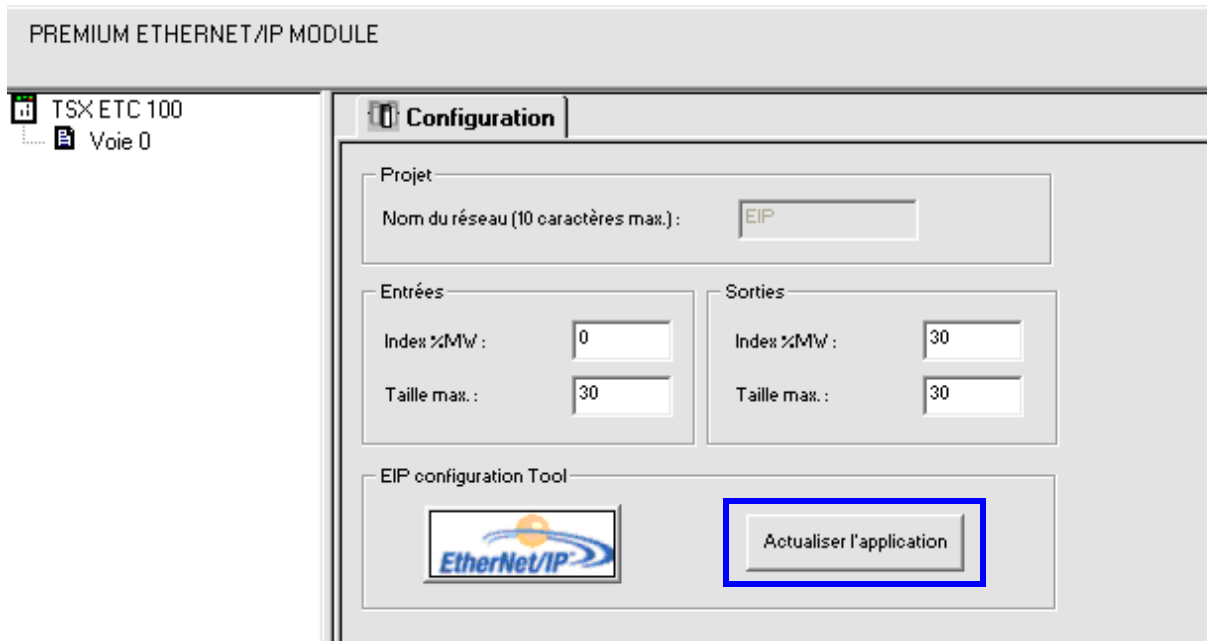

After this update, the Items configured in EIP configuration tool are present and can be used in UNITY program.

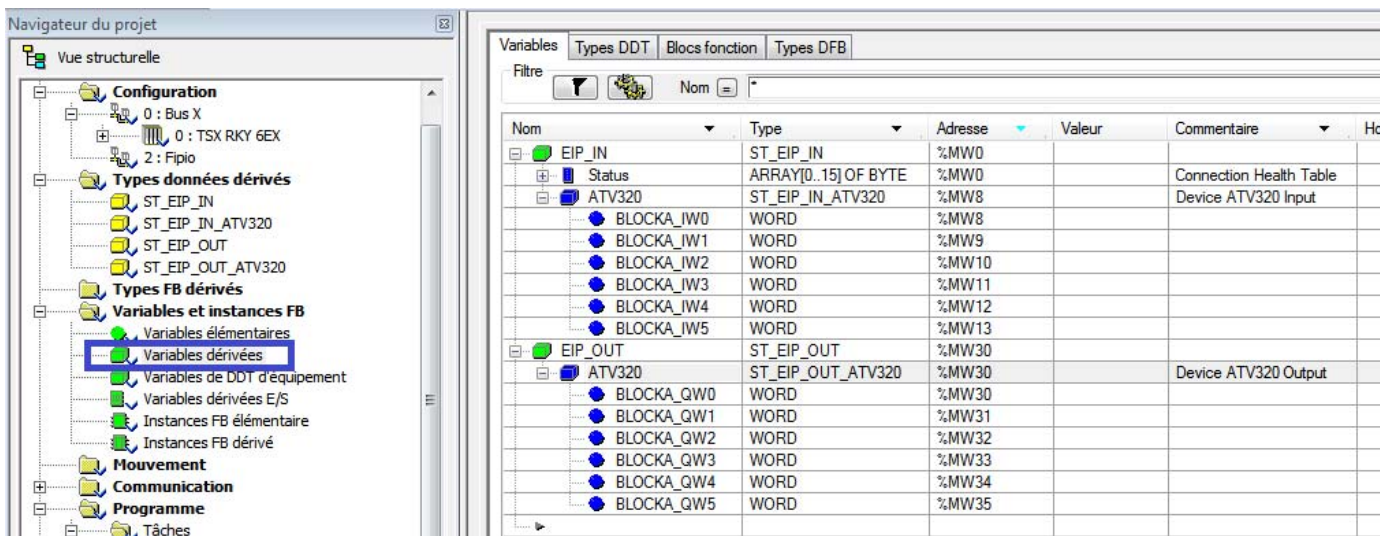

Explicit Messaging

An example of explicit messaging is shown below. The value of the ACC parameter (Modbus @ = 9001 / CIP address 16#8E:01:02).

Get Single Attribute

```
(*Get single attribut*)
if not reading_diagnostic [0] .0 and %M0 then
  reading_request_contents [0] :=16#0000; (*Reserved*)
  reading_request_contents [1] :=16#030E; (*03 - Request length in words / 0E - Get single*)
  reading_request_contents [2] :=16#8E20; (*Class*)
  reading_request_contents [3] :=16#0124; (*Instance*)
  reading_request_contents [4] :=16#0230; (*Attribut*)
  reading_diagnostic [3] :=16#0A; (*Fixed size of request in bytes*)
  SEND_REQ (addr('0.2.0.1'),16#000E,reading_request_contents,reading_diagnostic,reading_results);
  %M0:=False
End_if;
```

SEND_REQ description:

(0.2.0.1): Rack.location.way.equipment number

16#000E: messaging CIP (mandatory)

Set Single Attribute

```
(*Set single attribut*)
if not writing_diagnostic [0] .0 and %M1 then
  writing_request_contents [0] :=16#0000; (*Reserved*)
  writing_request_contents [1] :=16#0310; (*03 - Request length in words / 10 - SET single*)
  writing_request_contents [2] :=16#8E20; (*Class*)
  writing_request_contents [3] :=16#0124; (*Instance*)
  writing_request_contents [4] :=16#0230; (*Attribut*)
  writing_request_contents [5] :=35; (*value to write*)
  writing_diagnostic [3] :=16#0c; (*size of request in bytes*)
  SEND_REQ (addr('0.2.0.1'),16#000E,writing_request_contents,writing_diagnostic,writing_results);
  %M1:=False
End_if;
```

SEND_REQ description:

(0.2.0.1): Rack.location.way.equipment number

16#000E: messaging CIP (mandatory)

Get All Attribute

```
(*Get all attribut*)
if not reading_diagnostic_all [0] .0 and %M2 then
  reading_request_contents_all [0] :=16#0000; (*Reserved*)
  reading_request_contents_all [1] :=16#0201; (*02 - Request length in words / 01 - Get All*)
  reading_request_contents_all [2] :=16#8E20; (*Class*)
  reading_request_contents_all [3] :=16#0124; (*Instance*)
  reading_diagnostic_all [3] :=16#08; (*Fixed size of request in bytes*)
  SEND_REQ
(addr('0.2.0.1'),16#000E,reading_request_contents_all,reading_diagnostic_all,reading_results_all);
  %M2:=False
End_if;
```

SEND_REQ description:

(0.2.0.1): Rack.location.way.equipment number

16#000E: messaging CIP (mandatory)

Set All Attribute

```
(*Set all attribut*)
if not reading_diagnostic_all [0] .0 and %M3 then
  writing_request_contents_all [0] :=16#0000; (*Reserved*)
  writing_request_contents_all [1] :=16#0202; (*02 - Request length in words / 02 - SET All*)
  writing_request_contents_all [2] :=16#8E20; (*Class*)
  writing_request_contents_all [3] :=16#0124; (*Instance*)
  writing_diagnostic_all [3] :=16#2A; (*size of request in bytes*)
  SEND_REQ
(addr('0.2.0.1'),16#000E,writing_request_contents_all,writing_diagnostic_all,writing_results_all);
  %M3:=False
End_if;
```

SEND_REQ description:

(0.2.0.1): Rack.location.way.equipment number

16#000E: messaging CIP (mandatory)

Profiles

**11**

What's in this Chapter?

This chapter contains the following topics:

Topic	Page
Definition of a Profile	77
Functional Profiles Supported by the Altivar 320	78

Definition of a Profile

There are three types of profile:

- Communication profiles
- Functional profiles
- Application profiles

Communication Profiles

A communication profile describes the characteristics of the bus or network:

- Cables
- Connectors
- Electrical characteristics
- Access protocol
- Addressing system
- Periodic exchange service
- Messaging service
- ...

A communication profile is unique to a type of network (Modbus CIP, Profibus DP, etc.) and is used by various different types of device.

Functional Profiles

A functional profile describes the behavior of a type of device. It defines:

- Functions
- Parameters (name, format, unit, type, etc.)
- Periodic I/O variables
- State chart(s)
- ...

A functional profile is common to all members of a device family (variable speed drives, encoders, I/O modules, displays, etc.).

They can feature common or similar parts. The standardized (IEC 61800-7) functional profiles of variable speed drives are:

- CiA402
- PROFIDRIVE
- CIP

DRIVECOM has been available since 1991.

CiA402 "Device profile for drives and motion control" represents the next stage of this standard's development and is now part of the IEC 61800-7 standard.

Some protocols also support the ODVA (Open DeviceNet Vendor Association) profile.

Application Profiles

Application profiles define in their entirety the services to be provided by the devices on a machine. For example, "CiA DSP 417-2 V 1.01 part 2: CANopen application profile for lift control systems - virtual device definitions".

Interchangeability

The aim of communication and functional profiles is to achieve interchangeability of the devices connected via the network.

Functional Profiles Supported by the Altivar 320

I/O Profile

Using the I/O profile simplifies PLC programming.

The I/O profile mirrors the use of the terminal strip for control by utilizing 1 bit to control a function.

With an Altivar 320, the I/O profile can also be used when controlling via a network.

The drive starts up as soon as the run command is sent.

15 bits of the control word (bits 1 to 15) can be assigned to a specific function.

This profile can be developed for simultaneous control of the drive via:

- The terminals
- The Modbus control word
- The CANopen control word
- The network module control word

The I/O profile is supported by the drive itself and therefore in turn by all the communication ports (integrated Modbus, CANopen, Ethernet, Profibus DP, DeviceNet communication modules).

CiA402 Profile

The drive only starts up following a command sequence.

The control word is standardized.

5 bits of the control word (bits 11 to 15) can be assigned to a function.

The CiA402 profile is supported by the drive itself and therefore in turn by all the communication ports (integrated Modbus, CANopen, Ethernet, Profibus DP, DeviceNet communication modules).

The Altivar 320 supports the CiA402 profile's "Velocity mode".

In the CiA402 profile, there are two modes that are specific to the Altivar 320 and characterize command and reference management:

- Separate mode **[Separate]** (SEP)
- Not separate mode **[Not separ.]** (S, N)

See "CiA402 - IEC61800-7 Functional Profile" on page 79.

CiA®402 - IEC61800-7 Functional Profile

12

What's in this Chapter?

This chapter contains the following topics:

Topic	Page
Functional Description	80
CiA402 State Chart	81
Description of States	82
Summary	83
Control Word (CMd)	84
Stop Commands	85
Assigning Control Word Bits	85
Status Word (EtA)	86
Starting Sequence	87
Sequence for a Drive Powered by the Power Section Line Supply	88
Sequence for a Drive With Separate Control Section	90
Sequence for a Drive With Line Contactor Control	93

Functional Description

Drive operation involves two main functions, which are illustrated in the diagrams below.

CiA402

The main parameters are shown with their CiA402 name and their CiA402/Drivecom index (the values in brackets are the CANopen addresses of the parameter).

Control diagram:

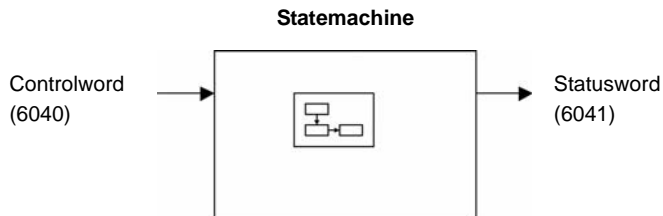

Simplified diagram of speed control in “Velocity” mode:

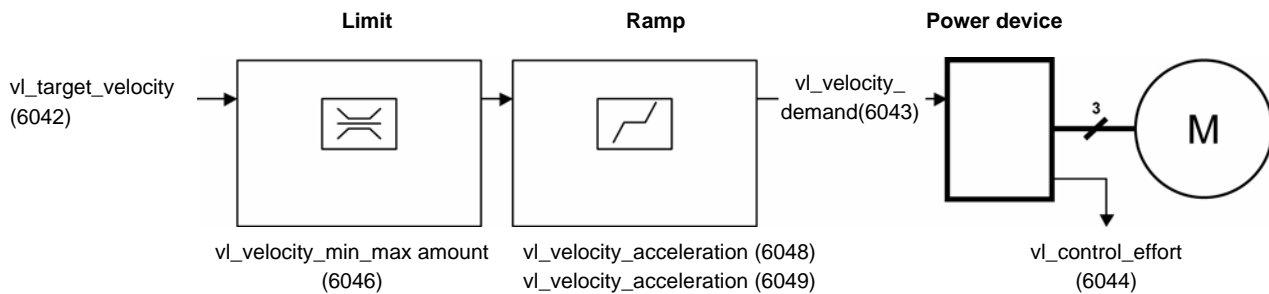

Altivar 320

These diagrams translate as follows for the Altivar system.

Control diagram:

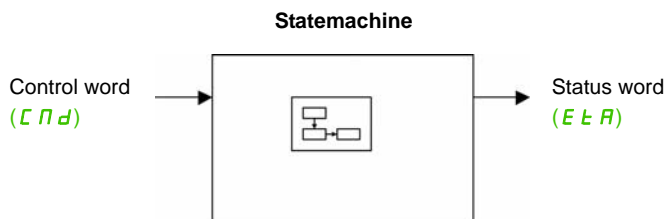

Simplified diagram of speed control in “Velocity” mode:

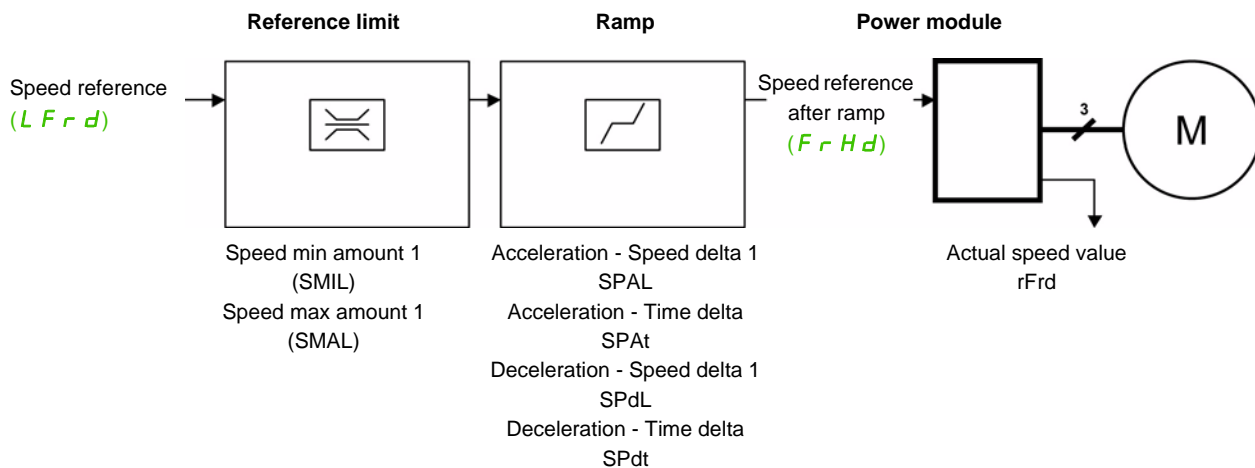

CiA402 State Chart

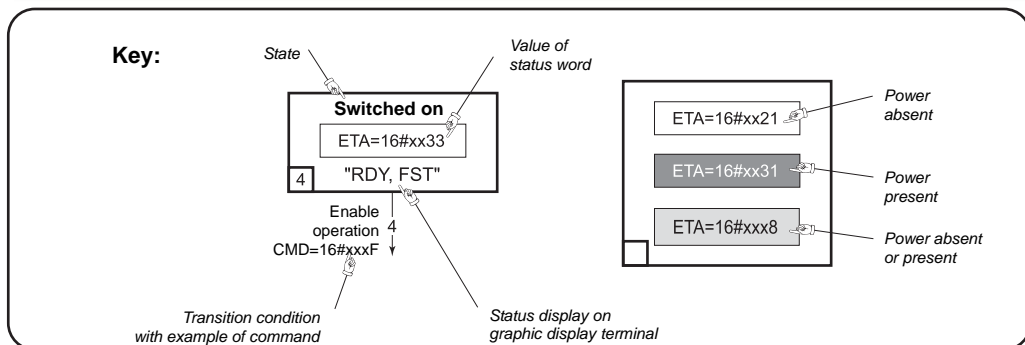
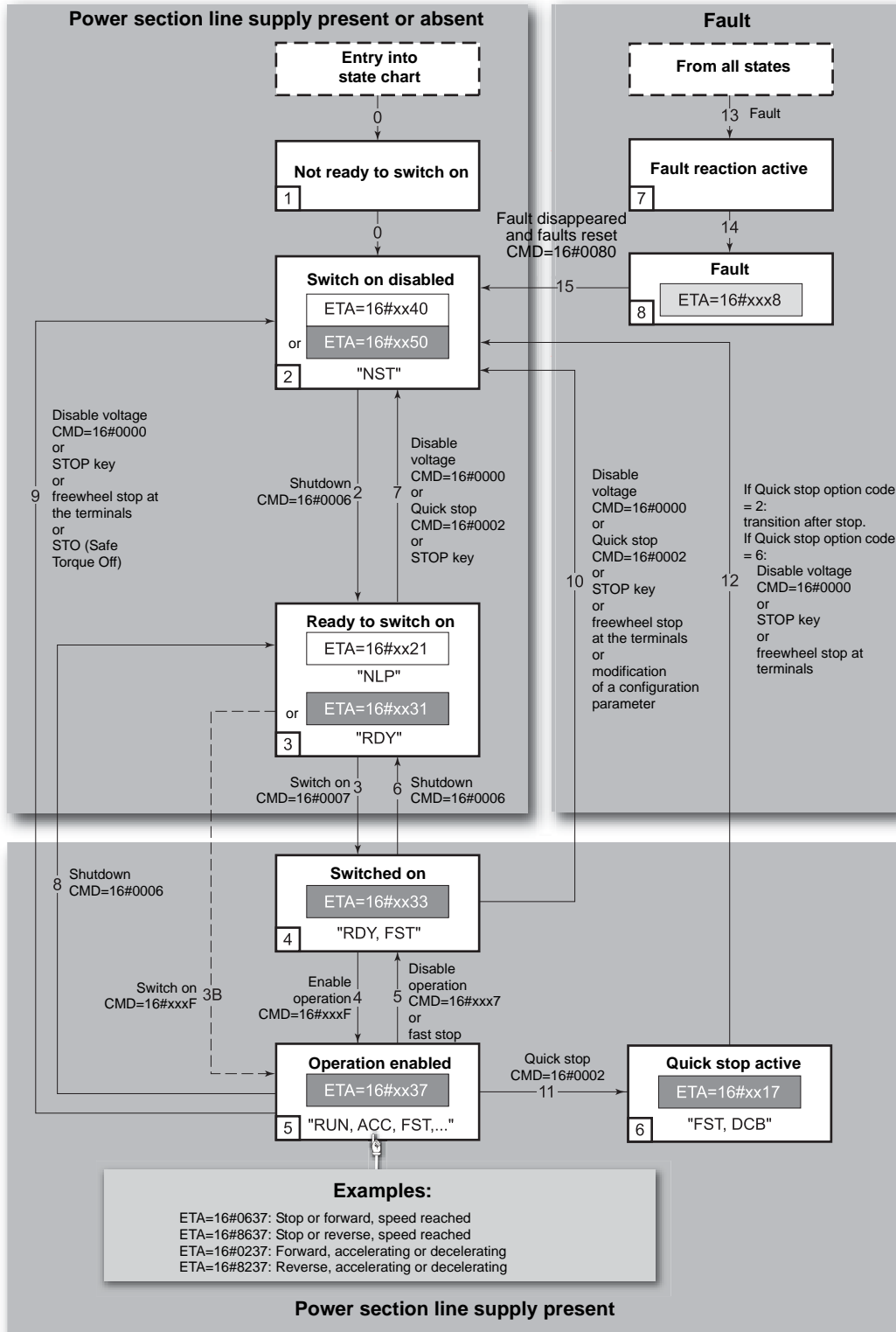

Description of States

Each state represents an internal reaction by the drive.

This chart will change depending on whether the control word is sent (**C P d**) or an event occurs (a detected fault, for example).

The drive state can be identified by the value of the status word (**E L R**).

State	Drive internal reaction
1 - Not ready to switch on	Initialization starts. This is a transient state invisible to the communication network.
2 - Switch on disabled	The drive is inactive. The drive is locked, no power is supplied to the motor. For a separate control section, it is not necessary to supply AC power to the power section. For a separate control section with line contactor, the contactor is not controlled. The configuration and adjustment parameters can be modified.
3 - Ready to switch on	Awaiting power section line supply. For a separate control section, it is not necessary to supply AC power to the power section, but the system will expect it in order to change to state "4 - Switched on". For a separate control section with line contactor, the contactor is not controlled. The drive is locked, no power is supplied to the motor. The configuration and adjustment parameters can be modified.
4 - Switched on	The drive is supplied with AC power but is stationary. For a separate control section, the power section line supply must be present. For a separate control section with line contactor, the contactor is controlled. The drive is locked, no power is supplied to the motor. The power stage of the drive is ready to operate, but voltage has not yet been applied to the output. The adjustment parameters can be modified. Modification of a configuration parameter returns the drive to state "2 - Switch on disabled".
5 - Operation enabled	The drive is running. For a separate control section, the power section line supply must be present. For a separate control section with line contactor, the contactor is controlled. The drive is unlocked, power is supplied to the motor. The drive functions are activated and voltage is applied to the motor terminals. If the reference is zero or the "Halt" command is applied, no power is supplied to the motor and no torque is applied. [Auto tuning] (t u n) requires an injection of current into the motor. The drive must therefore be in state "5 - Operation enabled" for this command. The adjustment parameters can be modified. The configuration parameters cannot be modified. NOTE: The command "4 - Enable operation" must be taken into consideration only if the channel is valid. In particular, if the channel is involved in the command and the reference, transition 4 will take place only after the reference has been received for the first time. The reaction of the drive to a "Disable operation" command depends on the value of the [Dis. operat opt code] (d o t d) parameter: <ul style="list-style-type: none"> - If the [Dis. operat opt code] (d o t d) parameter has the value 0, the drive changes to "4 - Switched on" and stops in freewheel stop. - If the [Dis. operat opt code] (d o t d) parameter has the value 1, the drive stops on ramp and then changes to "4 - Switched on".
6 - Quick stop active	Emergency stop. The drive performs a fast stop, after which restarting will only be possible once the drive has changed to the "Switch on disabled" state. During fast stop, the drive is unlocked and power is supplied to the motor. The configuration parameters cannot be modified. The condition for transition 12 to state "2 - Switch on disabled" depends on the value of the parameter Quick stop mode (QStd): If the Quick stop mode parameter has the value FST2, the drive stops according to the fast stop ramp and then changes to state "2 - Switch on disabled". If the Quick stop mode parameter has the value FST6, the drive stops according to the fast stop ramp and then remains in state "6 - Quick stop active" until: <ul style="list-style-type: none"> - A "Disable voltage" command is received. - Or the STOP key is pressed. - Or there is a freewheel stop command via the terminals.

State	Drive internal reaction
7 - Fault reaction active	Transient state during which the drive performs an action appropriate to the type of detected fault. The drive function is activated or deactivated according to the type of reaction configured in the detected fault management parameters.
8 - Fault	Drive has detected a fault. The drive is locked, no power is supplied to the motor.

Summary

State	Power section line supply for separate control section	Power supplied to motor	Modification of configuration parameters
1 - Not ready to switch on	Not required	No	Yes
2 - Switch on disabled	Not required	No	Yes
3 - Ready to switch on	Not required	No	Yes
4 - Switched on	Required	No	Yes, return to "2 - Switch on disabled" state
5 - Operation enabled	Required	Yes	No
6 - Quick stop active	Required	Yes, during fast stop	No
7 - Fault reaction active	Depends on detected fault management configuration	Depends on detected fault management configuration	-
8 - Fault	Not required	No	Yes

Control Word (CWD)

bit 7	bit 6	bit 5	bit 4	bit 3	bit 2	bit 1	bit 0
Fault reset	Reserved (=0)	Reserved (=0)	Reserved (=0)	Enable operation	Quick stop	Enable voltage	Switch on
0 to 1 transition = Ack. fault				1 = Run command	0 = Emergency stop	Authorization to supply AC power	Contact control

bit 15	bit 14	bit 13	bit 12	bit 11	bit 10	bit 9	bit 8
Manufacturer specific Assignable	Manufacturer specific Assignable	Manufacturer specific Assignable	Manufacturer specific Assignable	Manufacturer specific	Reserved (=0)	Reserved (=0)	Halt
				0 = Forward direction asked 1= Reverse direction asked			Halt

Command	Transition address	Final state	bit 7	bit 3	bit 2	bit 1	bit 0	Example value
			Fault reset	Enable operation	Quick stop	Enable voltage	Switch on	
Shutdown	2, 6, 8	3 - Ready to switch on	x	x	1	1	0	16#0006
Switch on	3	4 - Switched on	x	x	1	1	1	16#0007
Enable operation	4	5 - Operation enabled	x	1	1	1	1	16#000F
Disable operation	5	4 - Switched on	x	0	1	1	1	16#0007
Disable voltage	7, 9, 10, 12	2 - Switch on disabled	x	x	x	0	x	16#0000
Quick stop	11	6 - Quick stop active	x	x	0	1	x	16#0002
	7, 10	2 - Switch on disabled						
Fault reset	15	2 - Switch on disabled	0 → 1	x	x	x	x	16#0080

x: Value is of no significance for this command.

0 → 1: Command on rising edge.

Stop Commands

The “Halt” command enables movement to be interrupted without having to leave the “5 - Operation enabled” state. The stop is performed in accordance with the **[Type of stop] (S E E)** parameter.

If the “Halt” command is active, no power is supplied to the motor and no torque is applied.

Regardless of the assignment of the **[Type of stop] (S E E)** parameter (**[Fast stop assign] (F S E)**, **[Ramp stop] (r P P)**, **[Freewheel] (r S E)**, or **[DC injection assign.] (d C i)**), the drive remains in the “5 - Operation enabled” state.

A Fast Stop command at the terminals or using a bit of the control word assigned to Fast Stop causes a change to the “4 - Switched on” state. A “Halt” command does not cause this transition.

A Freewheel Stop command at the terminals or using a bit of the control word assigned to Freewheel Stop causes a change to the “2 - Switch on disabled” state. A “Halt” command does not cause this transition.

Assigning Control Word Bits

In the CiA402 profile, fixed assignment of a function input is possible using the following codes:

Bit	Network module
bit 11	C311
bit 12	C312
bit 13	C313
bit 14	C314
bit 15	C315

For example, to assign the DC injection braking to bit 13 of Ethernet, simply configure the **[DC injection assign.] (d C i)** parameter with the **[C313] (C 3 1 3)** value.

Bit 11 is assigned by default to the operating direction command **[Reverse Assign] (r r 5)**.

Status Word (E L F)

bit 7	bit 6	bit 5	bit 4	bit 3	bit 2	bit 1	bit 0
Warning	Switch on disabled	Quick stop	Voltage enabled	Fault	Operation enabled	Switched on	Ready to switch on
Alarm	Power section line supply disabled	0 = Emergency stop	Power section line supply present	Fault	Running	Ready	1 = Awaiting power section line supply

bit 15	bit 14	bit 13	bit 12	bit 11	bit 10	bit 9	bit 8
Manufacturer specific Direction of rotation	Manufacturer specific Stop via STOP key	Reserved (=0)	Reserved (=0)	Internal limit active	Target reached	Remote	Reserved (=0)
				Reference outside limits	Reference reached	Command or reference via network	

Status	bit 6	bit 5	bit 4	bit 3	bit 2	bit 1	bit 0	ETA masked by 16#006F ⁽¹⁾
	Switch on disabled	Quick stop	Voltage enabled	Fault	Operation enabled	Switched on	Ready to switch on	
1 -Not ready to switch on	0	x	x	0	0	0	0	-
2 -Switch on disabled	1	x	x	0	0	0	0	16#0040
3 -Ready to switch on	0	1	x	0	0	0	1	16#0021
4 -Switched on	0	1	1	0	0	1	1	16#0023
5 -Operation enabled	0	1	1	0	1	1	1	16#0027
6 -Quick stop active	0	0	1	0	1	1	1	16#0007
7 -Fault reaction active	0	x	x	1	1	1	1	-
8 -Fault	0	x	x	1	0	0	0	16#0008 ⁽²⁾ or 16#0028

(1) This mask can be used by the PLC program to test the chart state.

(2) Detected fault following state "6 - Quick stop active".

x: In this state, the value of the bit can be 0 or 1.

Starting Sequence

The command sequence in the state chart depends on how power is being supplied to the drive. There are three possible scenarios:

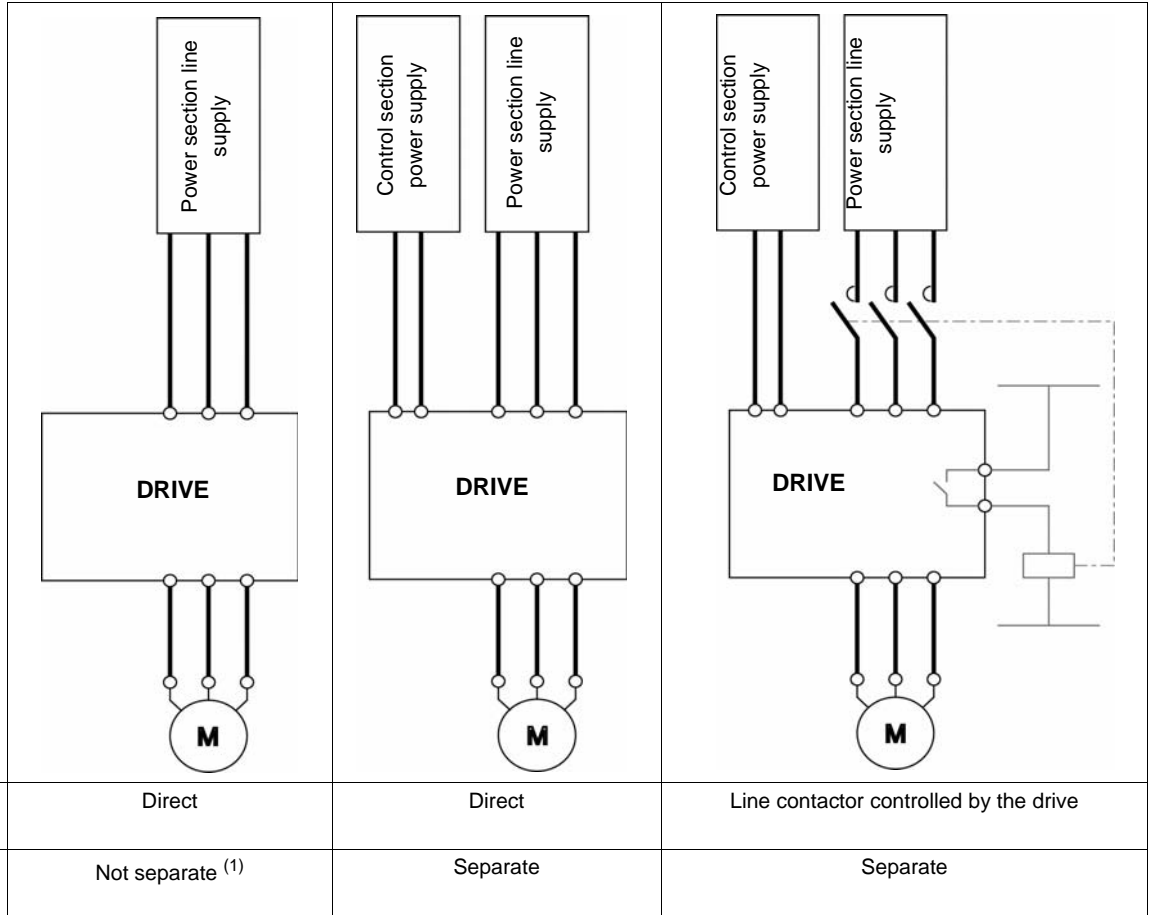

(1) The power section supplies the control section.

Sequence for a Drive Powered by the Power Section Line Supply

Both the power and control sections are powered by the power section line supply.
 If power is supplied to the control section, it has to be supplied to the power section as well.
 The following sequence must be applied:

Step 1

Send the "2 - Shutdown" command

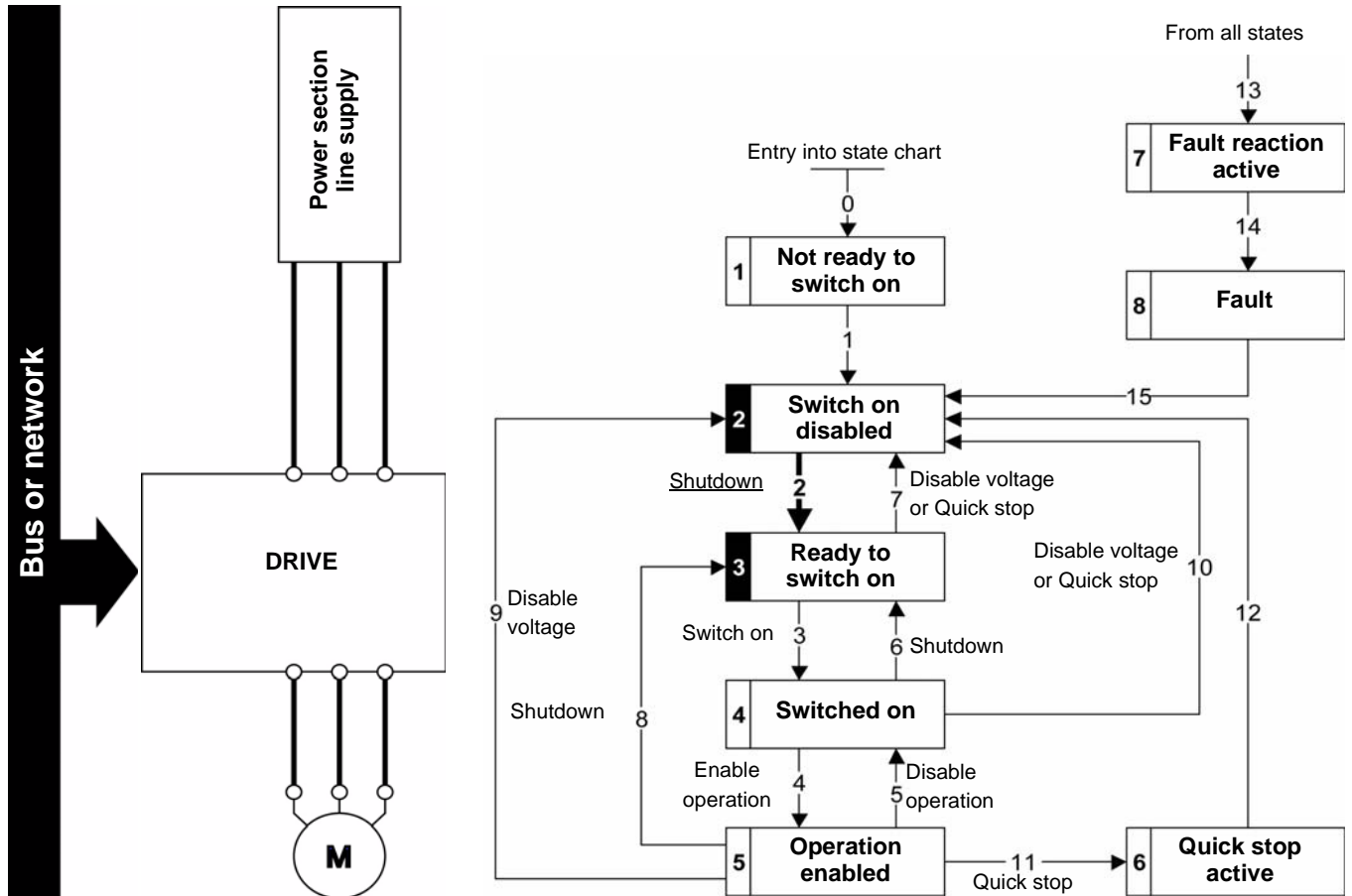

Step 2

- Check that the drive is in the “3 - Ready to switch on” state.
- Then send the “4 - Enable operation” command.
- The motor can be controlled (send a reference not equal to zero).

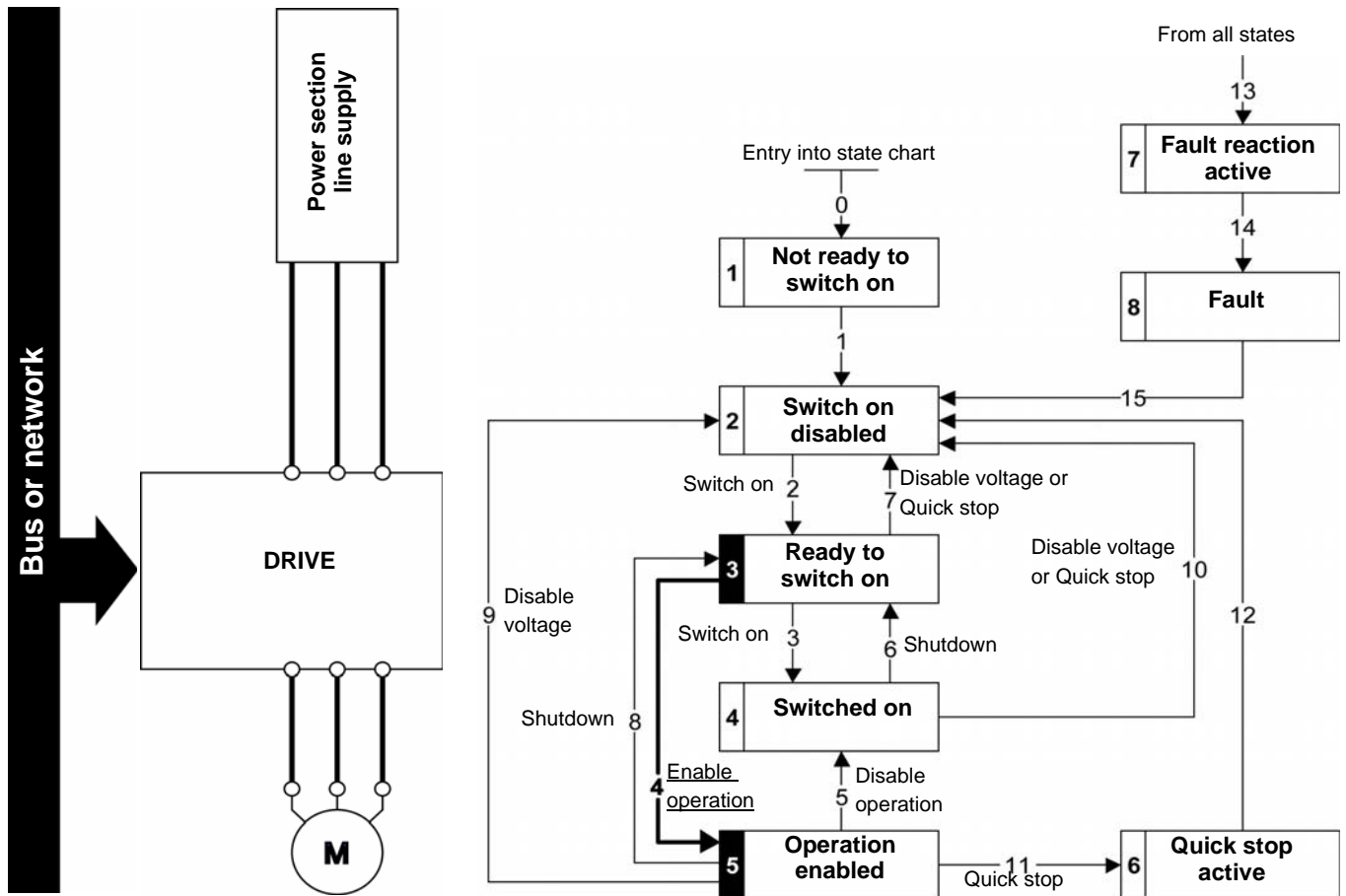

NOTE: It is possible, but not necessary, to send the “3 - Switch on” command followed by the “4 - Enable Operation” command to switch successively into the states “3 - Ready to Switch on”, “4 - Switched on” and then “5 - Operation Enabled”.
The “4 - Enable operation” command is sufficient.

Sequence for a Drive With Separate Control Section

Power is supplied separately to the power and control sections.

If power is supplied to the control section, it does not have to be supplied to the power section as well.

The following sequence must be applied:

Step 1

- The power section line supply is not necessarily present.
- Send the “2 - Shutdown” command

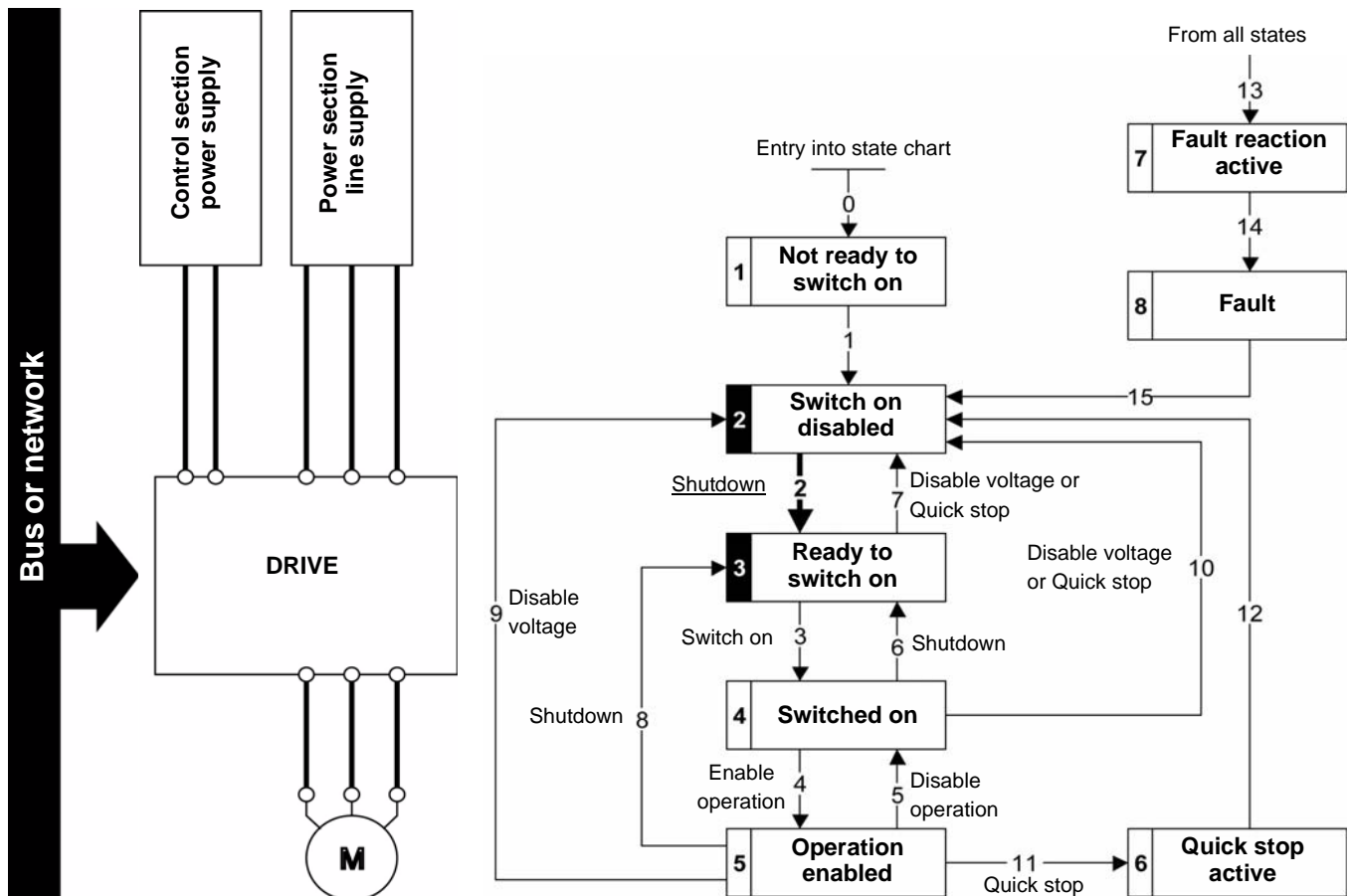

Step 2

- Check that the drive is in the “3 - Ready to switch on” state.
- Check that the power section line supply is present (“Voltage enabled” of the status word).

Power section line supply	Terminal display	Status word
Absent	nLP	16#●●21
Present	rdY	16#●●31

- Send the “3 - Switch on” command

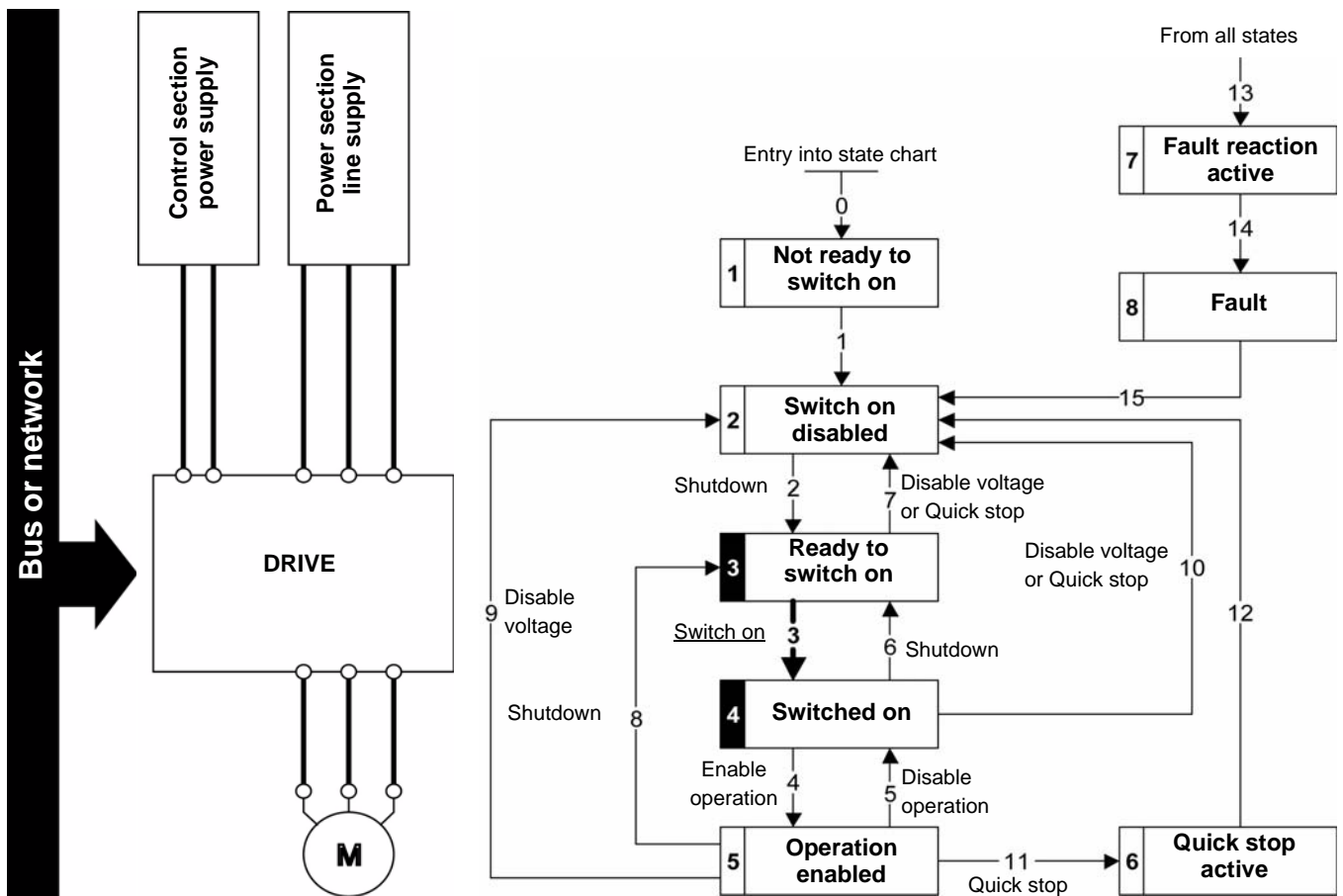

Step 3

- Check that the drive is in the “4 - Switched on” state.
- Then send the “4 - Enable operation” command.
- The motor can be controlled (send a reference not equal to zero).
- If the power section line supply is still not present in the “4 - Switched on” state after a time delay **[Mains V. time out] (L C E)**, the drive triggers an error **[Input Contactor] (L C F)**.

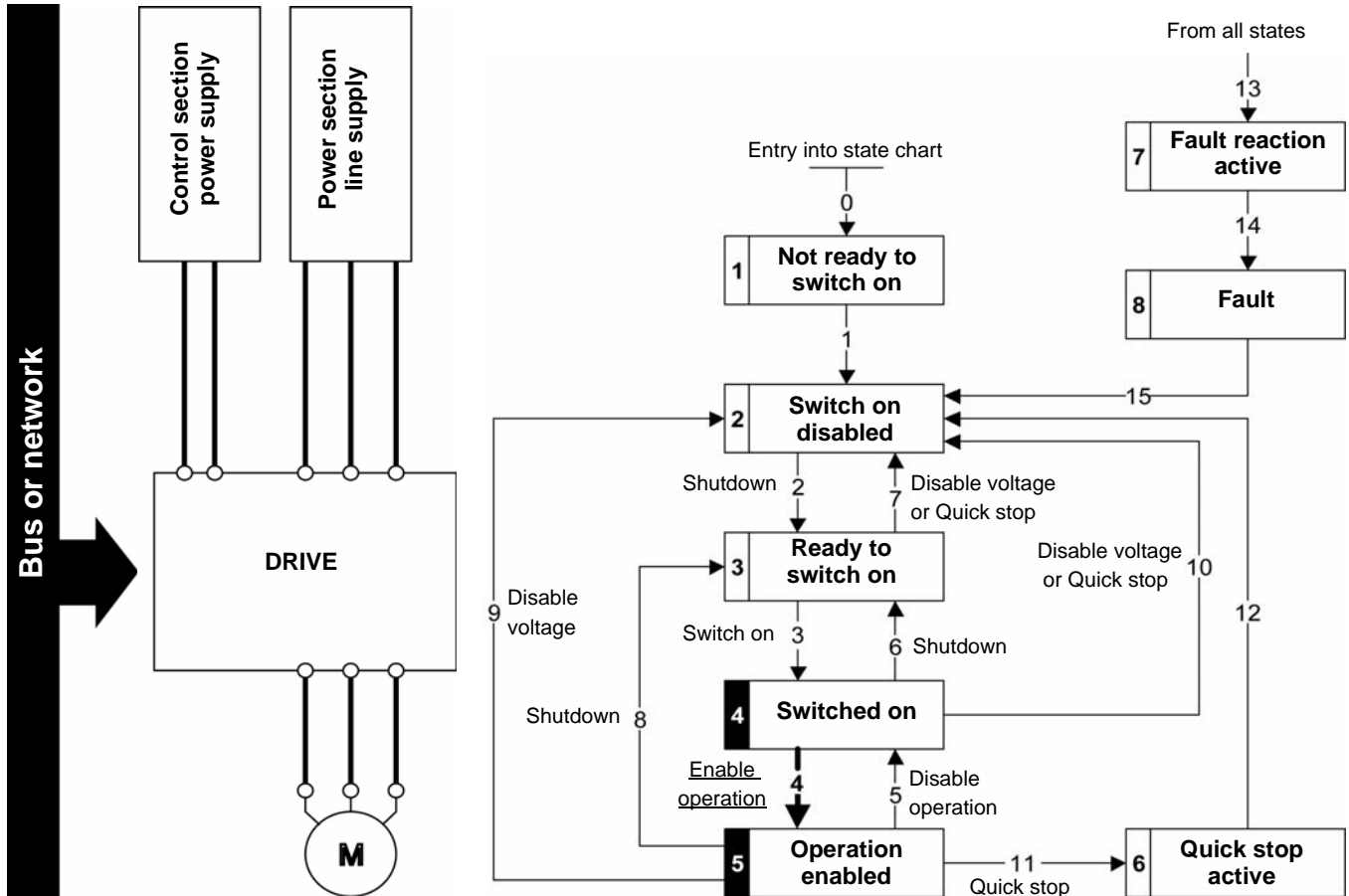

Sequence for a Drive With Line Contactor Control

Power is supplied separately to the power and control sections.

If power is supplied to the control section, it does not have to be supplied to the power section as well. The drive controls the line contactor.

The following sequence must be applied:

Step 1

- The power section line supply is not present as the line contactor is not being controlled.
- Send the "2 - Shutdown" command

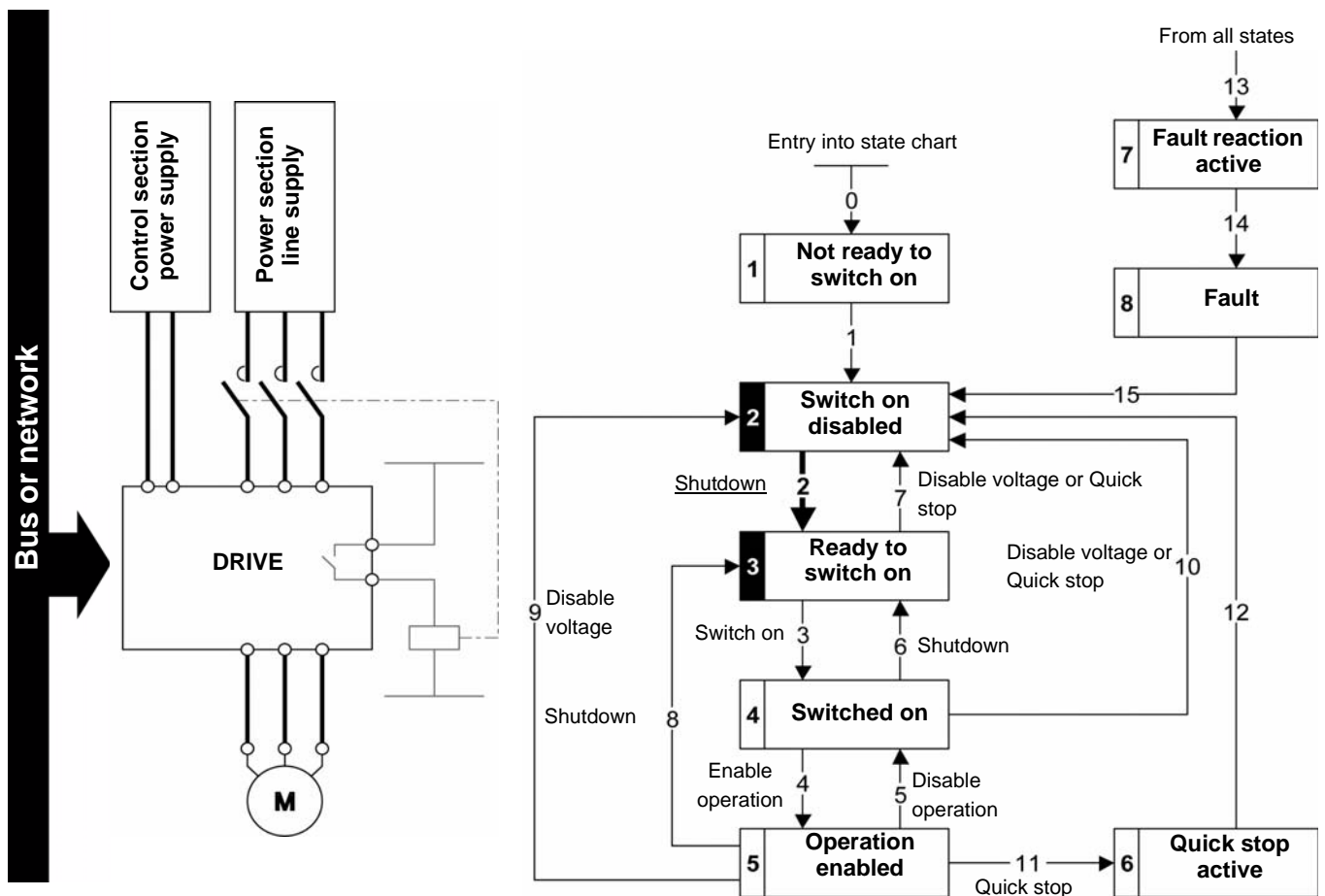

Step 2

- Check that the drive is in the “3 - Ready to switch on” state.
- Send the “3 - Switch on” command, which will close the line contactor and switch on the power section line supply.

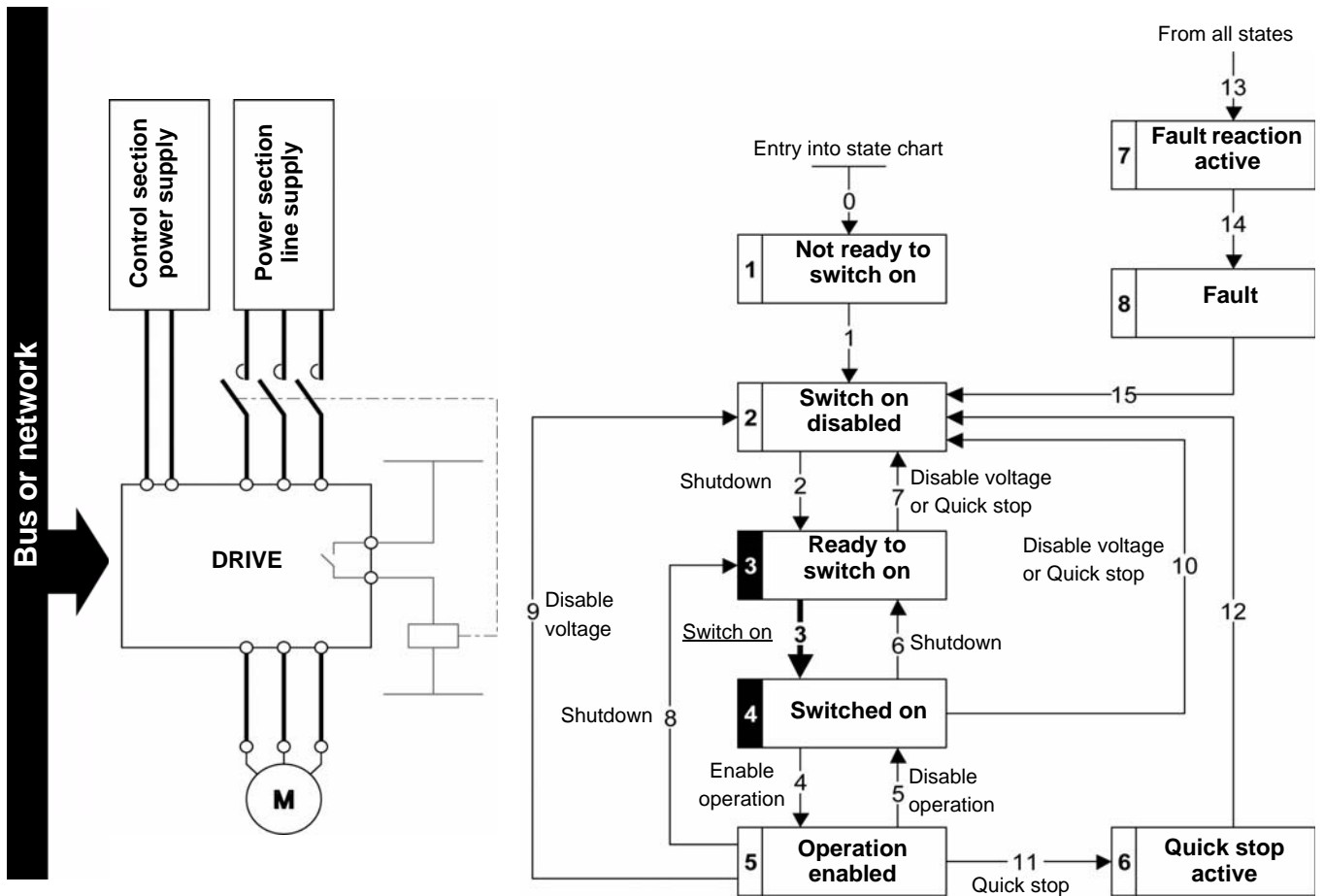

CIP Objects Overview

13**Overview**

This chapter shows an overview of the CIP objects. For more details, please refer to the “CIP Objects” on page 137.

What's in this Chapter?

This chapter contains the following topics:

Topic	Page
Objects in the AC/DC Drive Device	96
Object 28hex (Motor Data)	96
Object 29hex (Control Supervisor)	97
Object 2Ahex (AC/DC Drive)	98

Objects in the AC/DC Drive Device

The following table gives the list of objects that shall be implemented in the options:

Object	Description
Identity	This object provides identification of and general information about the device
Message Router	The Message Router Object provides a messaging connection point through which a Client may address a service to any object class or instance residing in the physical device
Ethernet Link	The Ethernet Link Object maintains link-specific counters and status information for a Ethernet 802.3 communications interface
TCP/IP Interface	The TCP/IP Interface Object provides the mechanism to configure a device's TCP/IP network interface. Examples of configurable items include the device's IP Address, Network Mask, and Gateway Address
Connection manager	Use this object for connection and connectionless communications, including establishing connections across multiple subnets
Assemblies	The Assembly Object binds attributes of multiple objects, which allows data to or from each object to be sent or received over a single connection
Control supervisor	Manages drive functions, operational states and control
AC/DC drive	Provides drive configuration
Motor data	Defines motor data for the motor connected to the device

Object 28hex (Motor Data)

Path	CIP name	Altivar name
16#28/01/03 = 40/1/3	MotorType	Squirrel Cage Induction Motor
16#28/01/06 = 40/1/6	RatedCurrent	Rated mot. current
16#28/01/07 = 40/1/7	RatedVoltage	Rated motor volt.
16#28/01/09 = 40/1/9	RatedFreq	Rated motor freq.
16#28/01/0F = 40/1/15	BaseSpeed	Rated motor speed

Object 29hex (Control Supervisor)

Path	CIP name	Altivar name
16#29/01/03 = 41/1/3	Run1	-
16#29/01/07 = 41/1/7	Running1	-
16#29/01/0A = 41/1/10	Faulted	-
16#29/01/0C = 41/1/12	FaultRst	-
16#29/01/0D = 41/1/13	FaultCode	CiA402 detected fault code

Control Supervisor State Transition Diagram

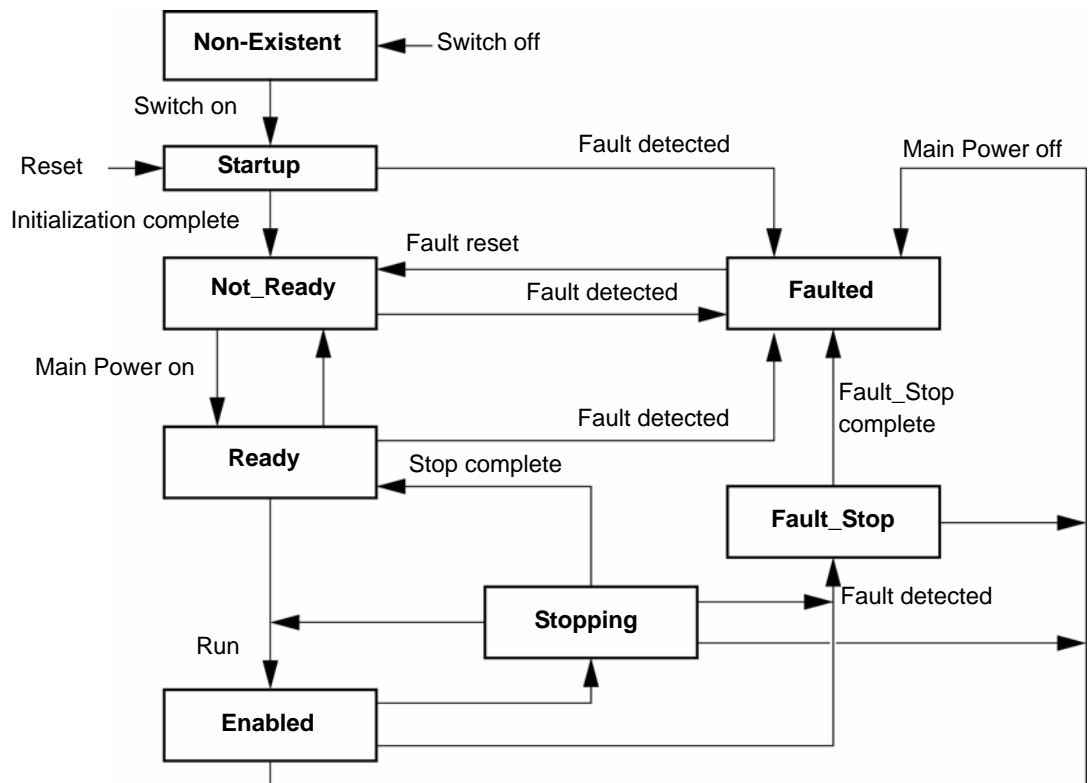

Object 2Ahex (AC/DC Drive)

AC/DC Drive

Path	CIP Name	Altivar Name	CIP Configuration Parameter Name
16#2A/01/07 = 42/1/4	NetRef	-	Requests speed reference to local or from network
16#2A/01/07 = 42/1/7	SpeedActual	Output velocity	Speed Actual
16#2A/01/08 = 42/1/8	SpeedRef	Speed setpoint	Speed Reference
16#2A/01/09 = 42/1/9	CurrentActual	Motor current	Current Actual
16#2A/01/0A = 42/1/10	CurrentLimit	Mot. therm. current	Current Limit
16#2A/01/0B = 42/1/11	TorqueActual	Output torque (Nm)	Torque Actual
16#2A/01/12 = 42/1/18	AccelTime	CIP acceleration time	Acceleration Time
16#2A/01/13 = 42/1/19	DecelTime	CIP deceleration time	Deceleration Time
16#2A/01/14 = 42/1/20	LowSpdLimit	CIP Low speed limit	Low Speed Limit
16#2A/01/15 = 42/1/21	HighSpdLimit	CIP High speed limit	High Speed Limit

Transparent Ready Features



14

What's in this Chapter?

This chapter contains the following topics:

Topic	Page
Presentation	100
Startup Detailed Behavior	101
FDR Operation Behavior	102
FDR Settings	103
Local Configuration	104
Downloaded Configuration	105

Presentation

The FDR (Fast Device Replacement) service is used to simplify the maintenance of drives connected on the Ethernet network. In the event of a drive malfunction, this service automatically reconfigures its replacement.

The new drive (FDR client) retrieves:

- its IP addresses and the FDR file path from a DHCP server
- the FDR file from an FTP server, if the drive is not configured in local configuration

In practice, the DHCP server and the FTP server are the same device (PLCs: TSX Premium, Quantum PLC or dedicated PCs).

The FDR file contains:

- the Ethernet parameters (configuration of I/O scanning, FDR etc.)
- the drive parameters (drive, functions, application, etc.)

The FDR service is based on identification of the device by a "Device Name". In the case of the Altivar 320 drive, this is represented by the **[Device Name]** (*Pfn*) parameter.

Configuration using the drive graphic display terminal or the integrated display terminal is explained in the "Configuration of the Drive Commands Settings" on page 34. Configuration using the standard Web server is explained in the "Embedded Webserver" on page 107. For configuration using the SoMove software workshop, refer to the software online help.

NOTE: Check that all the network devices do have different "Device Names".

The FDR server controls duplication of "Device Names" (it does not assign an IP address that has already been assigned and is active).

If the same IP address is supplied on 2 devices, the 2nd should trigger an IP address duplication (network management detected fault which leads to a drive detected error **[Fieldbus Error]** (*EPF2*) by default).

If the FDR service has been enabled, the Ethernet card attempts to restore its IP addresses on each power-up. Each time the procedure detects a fault, the Ethernet card reiterates its FDR requests (DHCP).

Where the configuration also needs to be downloaded by the FDR server:

After assigning the Ethernet card IP addresses, if the configuration download detects a fault, the Ethernet card detects a network management detected fault (which leads to a drive detected fault **[Fieldbus Error]** (*EPF2*) by default).

Startup Detailed Behavior

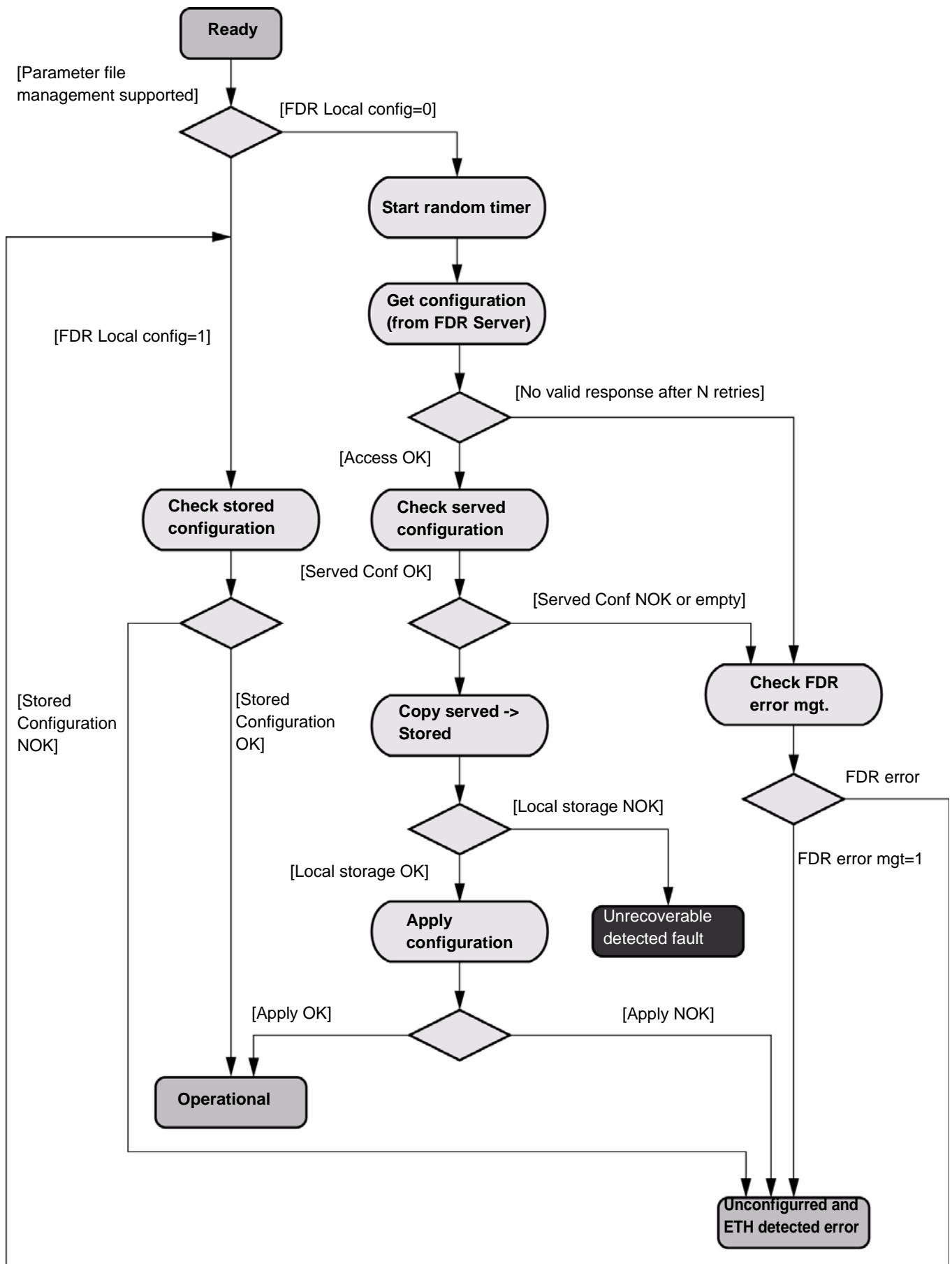

FDR Operation Behavior

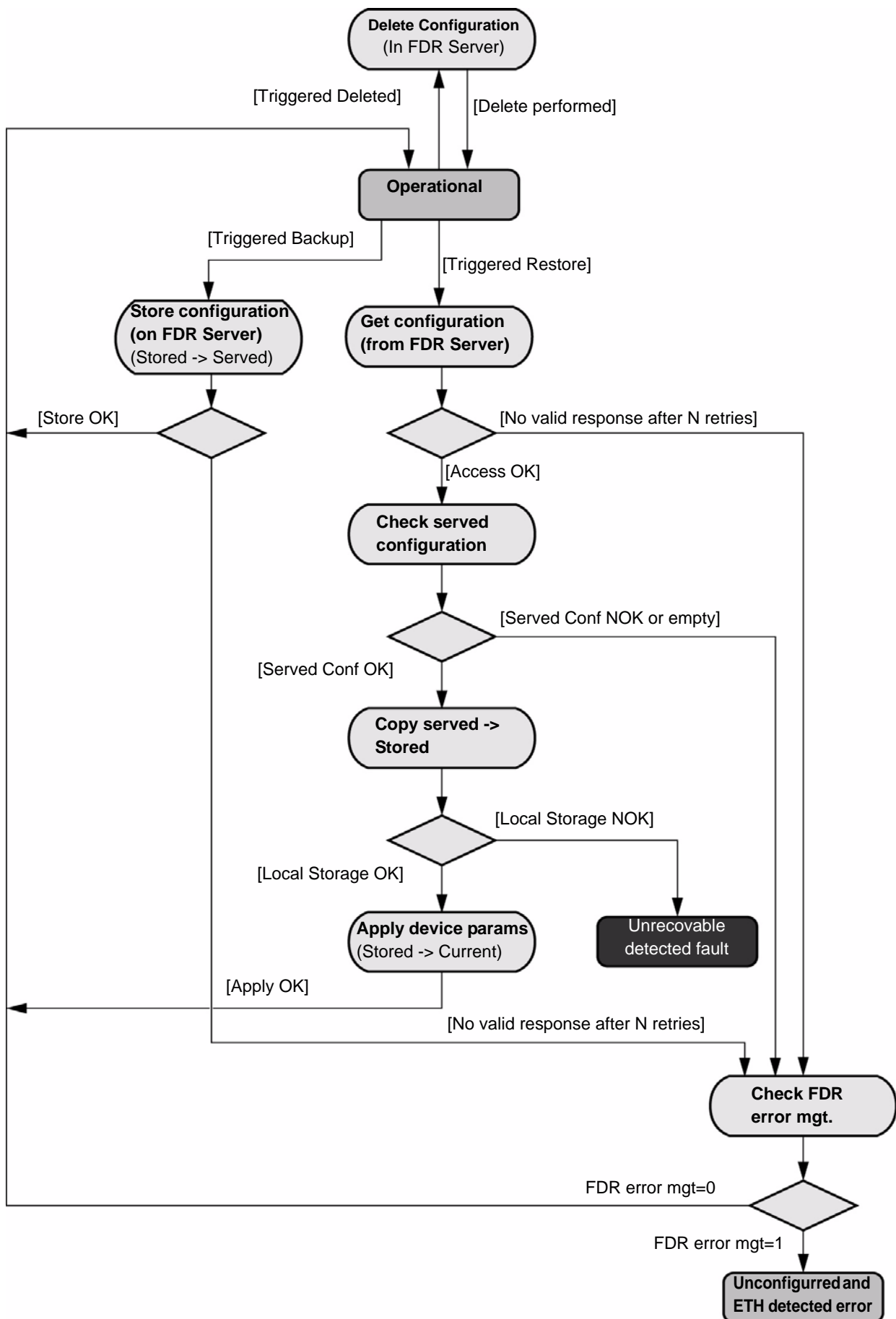

FDR Settings

The following table describes the FDR setting parameters:

Parameter Description (HMI mnemonic)	Range or Listed Values	Default	Long Name	Short Name	Access	Parameter Number
[IP FDR] (,PF -) (,PF 1) (,PF 2) (,PF 3) (,PF 4) These fields displays the served address of the FDR server	0 to 255 for each 4 fields	0.0.0.0	[0.0.0.0]	(0) (0) (0) (0)	R/W	64224 64225 64226 64227
[FDR Activation] (F d r u) Enable FDR service	0: no 1: yes	yes	[No] [Yes]	(n o) (y e s)	R/W	64228
[Ethernet local conf] (L C F G) Selection of local or server configuration	0: no 1: yes	no	[No] [Yes]	(n o) (y e s)	R/W	64238
[FDR file error] (F d r F) Enable FDR detected fault management	0: no 1: yes	yes	[No] [Yes]	(n o) (y e s)	R/W	64240
[FDR Action] (F d r R)	NOT ACTIVE: No command SAVE: save command REST: download command DEL: delete command	IDLE	[NOT ACTIVE] [SAVE] [REST] [DEL]	(i d L E) (S A V E) (r E S T) (d E L)	R/W	64229
[FDR Autosave] (F d r S) Interval for periodic saving of the FDR service	0: no 1: yes	no	[No] [Yes]	(n o) (y e s)	R/W	64230
[FDR Autosave Timer] (F d r T)	0 to 9999 minutes	0	[0]	(0)	R/W	64231
[FDR Status] (F d r E) FDR service status	- NOT ACTIVE: idle state - INIT: initialisation - CONF: configuration - RDY: ready - GET: download the current configuration - SET: save the current configuration - APP: Write the FDR server conf. to the drive - OPE: operational - UCFG: not configured	IDLE	[NOT ACTIVE] [INIT] [CONF] [RDY] [GET] [SET] [APP] [OPE] [UCFG]	(i d L E) (i n i t) (c o n f) (r d y) (g e t) (s e t) (a p p) (o p e) (u c f g)	RW	64232
[FDR Error Code] (F d r d)	- 0: No error - 2: the FDR configuration file is not compatible with the drive type - 3: Detected error reading the FDR configuration file on the server - 4: Detected error writing the configuration file to the server - 7: Time out for receipt of the FDR configuration file from the server - 9: duplicated IP address. - 12: the FDR configuration file is missing - 13: the FDR configuration file deployment on the drive has detected a fault (local detected error) - 14: the configuration file delete request has detected an error on the FDR server	0	[0] [2] [3] [4] [7] [9] [12] [13] [14]	(0) (2) (3) (4) (7) (9) (1 2) (1 3) (1 4)	R	64233

NOTE: During the application of the configuration, the option use the File Transfer mechanism (FTP) and some system services. If all the transfers are well finished, the operational state is reached. If the configuration is ok: the operational state is reached, else if the configuration is not ok: the unconfigured state is reached (FDR error #14).

Local Configuration

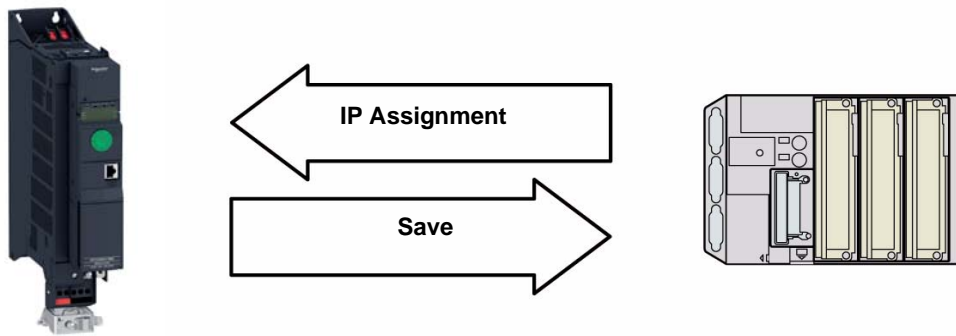

IP Assignment Save

If the drive parameter configuration is local, the FDR server only assigns the following IP addresses:

- Card IP address,
- Subnet mask,
- Gateway IP address.

On connection to the network, the drive automatically saves its parameters in the FDR server.

Drive Connection Procedure

To make the system operational, it is necessary to follow this procedure:

Step	Action
Configure the FDR server	See the PLC manual or the section on software setup using PL7
Configure the drive	In the [Communication] (C o m -) menu, [Communication module] (C b d -) submenu: Configure [IP mode] (, P m)=DHCP Enable the FDR service: [FDR Activation] (F d r u) = [Yes] (Y E S) Select local drive configuration: [Ethernet local conf] (L C F G) = [Yes] (Y E S) Enter the device name, [Device Name] , in the [Communication] (C o m -) menu, [Communication module] (C b d -) submenu
Turn off the drive	Turn the drive off and then back on again (control voltage if a separate power supply is being used), otherwise the device name is not taken into account
Connect the drive to the network	Connect the drive and the FDR server (PLC) to the Ethernet network

Downloaded Configuration

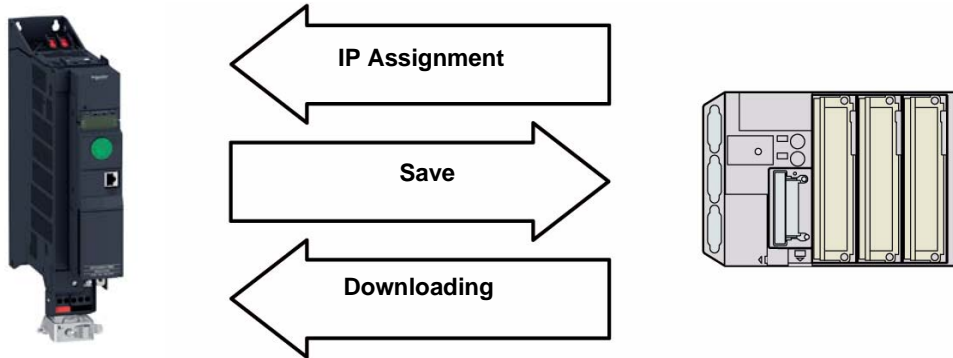

IP Assignment Save

If the drive parameter configuration has been downloaded, the FDR server assigns the following addresses:

- Card IP address,
- Subnet mask,
- Gateway IP address,
- FDR server IP address.

Periodic Saving

Periodic saving of the drive configuration can be configured on the FDR server in either local configuration or downloaded configuration mode.

In the **[Communication]** (*C o m -*) menu, **[Ethernet]** (*E t h -*) submenu,

- Select: **[FDR Autosave]** (*F d r S*) = **[Yes]** (*Y E S*).
- Set the **[FDR Autosave Timer]** (*F d r t*) parameter.

NOTE: Saving too often risks overburdening the network and adversely affecting its performance (factory setting: 10 min).

Other Commands

On request, the configuration saved in the FDR server can be downloaded to the drive using the **[FDR Action]** (*F d r A*) command = **[REST]** (*r E S T*). The saved configuration can be deleted from the FDR server using the **[FDR Action]** (*F d r A*) command = **[DEL]** (*d E L*).

Limitations

The FDR service is able to store the current configuration of the drive, but does not provide the possibility to store multi-configurations or multi-parameters configurations.

Drive Parameters (Configuration)

In the procedure described below, the configuration file is supplied to the FDR server, via the Ethernet network, using a save command performed on the drive graphic display terminal.

NOTE: This procedure can also be performed using a Web browser, which is more user-friendly than the drive graphic display terminal (see "Embedded Webserver" on page 107).

For the first use, it is necessary to follow the procedure below:

Step	Action
Configure the drive	<p>In the [Communication] (C O N -) menu, [Ethernet] (E t H -) submenu:</p> <ul style="list-style-type: none"> • Leave the IP address [IP card] (, P C 1) (, P C 2) (, P C 3) (, P C 4) at the value [0.0.0.0] (0) (0) (0) (0) • Enable the FDR service: [FDR Activation] (F d r u) = [Yes] (Y E 5) • Caution, before the first connection, you must select local drive configuration: [Ethernet local conf] (L C F G) = [Yes] (Y E 5). The drive must first supply the configuration to the server. <p>Enter the device name, [Device Name], in the [Display config.] menu, [User Parameters] submenu. This menu can only be accessed in expert mode: In the [Access Level] (L R C -) menu, set the level to [Expert] (E P r)</p>
Turn off the drive	Turn the drive off and then back on again (control voltage if a separate power supply is being used), otherwise the device name is not taken into account
Connect the drive to the network	Connect the drive and the FDR server (PLC) to the Ethernet network
Configure the FDR server (see the PLC manual)	<p>The server downloads the IP addresses to the Ethernet card.</p> <p>Check that the operation has proceeded correctly: you can also check, in the [Communication] (C O N -) menu, [Ethernet] (E t H -) submenu whether the [IP card] (, P C 1) (, P C 2) (, P C 3) (, P C 4), [IP Mask] (, P M 1) (, P M 2) (, P M 3) (, P M 4) and [IP Gate] (, P G 1) (, P G 2) (, P G 3) (, P G 4) parameters have values other than [0.0.0.0] (0) (0) (0) (0)</p>
Supply the FDR server with the configuration file	<p>Configure the drive parameters.</p> <p>In the [Communication] (C O N -) menu, [Ethernet] (E t H -) submenu:</p> <p>Specify that the drive configuration is to be downloaded from the FDR server on each power-up: [Ethernet local conf] (L C F G) = [No] (n o).</p> <p>Send a save command to the FDR server: [FDR Action] (F d r A) = [SAVE] (S A U E).</p> <p>After execution of the command, the [FDR Action] (F d r A) parameter reverts to the value [NOT ACTIVE] (, d L E)</p>
Check that the system is operational	<p>Check that the operation has proceeded correctly: the [FDR Status] (F d r E) parameter should be at the value [OPE] (o P E)</p> <p>If the save operation has not been successful, the card detects a communication (network management) detected fault which, in factory settings mode, triggers a drive detected fault [Fieldbus Error] (E P F 2)</p>

Replacing a Drive

For replace a drive, it is necessary to follow the procedure below:

Step	Action
Configure the drive	<p>In the [Communication] (C O N -) menu, [Ethernet] (E t H -) submenu:</p> <ul style="list-style-type: none"> • Leave the IP address [IP card] (, P C 1) (, P C 2) (, P C 3) (, P C 4) at the value [0.0.0.0] (0) (0) (0) (0) • Enable the FDR service: [FDR Activation] (F d r u) = [Yes] (Y E 5) • Specify that the drive configuration is to be downloaded from the FDR server on each power-up: [Ethernet local conf] (L C F G) = [No] (n o). <p>These configurations are the default values</p> <p>Enter the device name, [Device Name], in the [Display config.] menu, [User Parameters] submenu. This menu can only be accessed in expert mode: In the [Access Level] (L R C -) menu, set the level to [Expert] (E P r)</p>
Turn off the drive	Turn the drive off and then back on again (control voltage if a separate power supply is being used), otherwise the device name is not taken into account
Connect the drive to the network	Connect the drive and the FDR server (PLC) to the Ethernet network
Check that the drive is operational	<p>Check that the operation has proceeded correctly:</p> <ul style="list-style-type: none"> • The "STS" LED should be on • The [FDR Status] (F d r E) parameter should be at the value [OPE] (o P E) <p>If downloading has not been possible after a period of 2 min following assignment of the IP addresses, the card detects a communication (network management) detected fault which, in factory settings mode, triggers a drive detected fault [Fieldbus Error] (E P F 2)</p>

Embedded Webserver

**15**

What's in this Chapter?

This chapter contains the following topics:

Topic	Page
Overview	108
Connexion to the Webserver	108
Pages Description	109
FTP Server	117

Overview

The VW3A3616 provides an integrated web server which allows several functions like: monitoring, parameter settings and diagnostics. This chapter describes the services provided by this webserver.

The webserver can be accessed from standard browsers like Internet Explorer or Firefox.

Connexion to the Webservice

The webserver can be accessed from standard browsers like Internet Explorer or Firefox.

In the following example, the ATV320 has received the IP address 10.0.0.5:

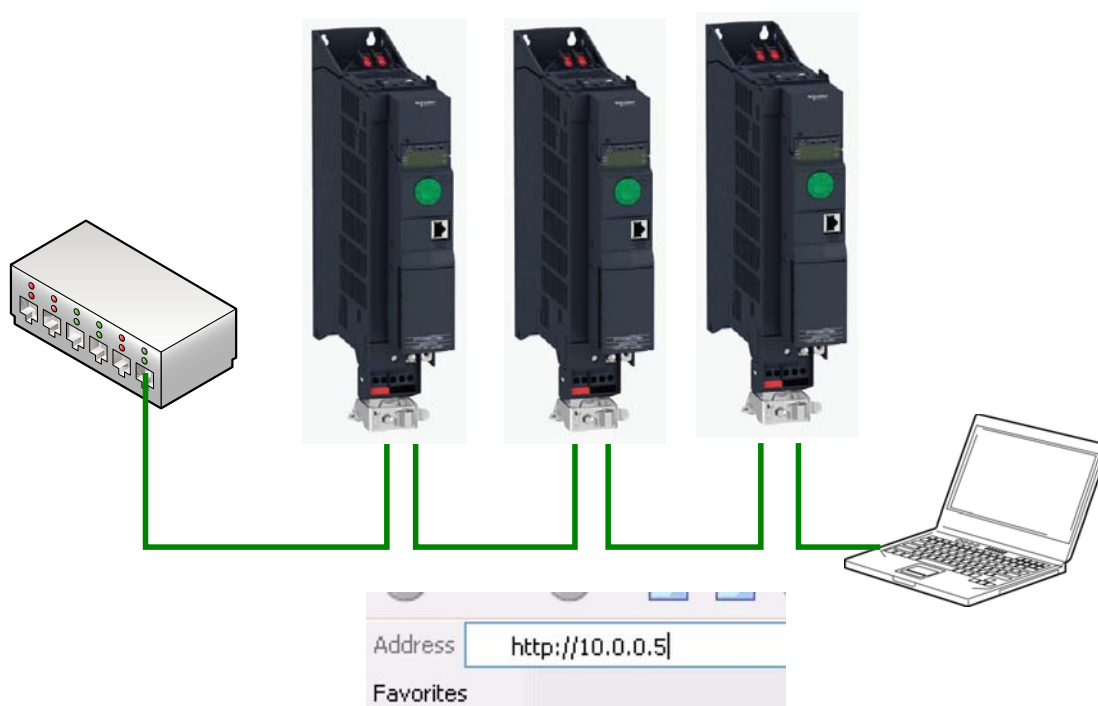

First connect the PLC to the ATV320 by typing `http://` followed by the ATV320 IP address.

You will be asked to first enter a User Name and a password.

By default the user name is USER and the password is also USER.

Once connected, the webserver home page is displayed.

Access Rights - Password and User Names

Before stating the description of the different topics of the server, you should notice that:

- “Web read password”: Access to the different pages requires a User access level. This is the first level of password, you can monitor and access to all the pages of the webserver, but not modify data.
 - User name: USER (default value)
 - Password: USER (default value)
- “Web write password”: Access to data or settings change, an Administrator access level is required.
 - Password: USER (default value).

The user names and the password of both level can be modified from the administration section (> homer > Network Setup > Administration).

Web Server Site Map

Home	Monitoring	Altivar viewer Drive parameters
	Network settings	Modbus TCP - I/O scanner configuration Ethernet/IP - I/O scanner configuration Fast device replacement Administration
	Diagnostics	TCP/IP statistics CIP and Ethernet/IP statistics

Pages Description

Home Page



Web site version : 1.0.0.0

The home page or “Home” menu contain the following item:
A “**Languages**” submenu containing a link to the “English” page.

The only link in the “Languages” submenu sends the user to the home page in English and configures the Web browser to open the HTML pages located in the corresponding directory.

(example: the “http://139.160.69.241/html/english/” directory becomes the standard directory in the case of English).

Note About Java Applets

The Webserver downloads Java programs called “applets” to your computer. These applets communicate with the drive using Modbus services (on port 502), thus establishing one or more connections between the computer and the drive. Until an applet has been fully transmitted from the drive to the browser, a gray rectangle appears in the place reserved for it in the page.

The applets associated with the Web pages monitor communication with the drive. When the drive no longer responds to requests to update the data, the message “Link down” is displayed in one field and all the other field contents are emptied.

Subsequently, the description of each page indicates the data refresh period requested by the applet loaded on the computer. The refresh period actually observed depends on:

- The performance of the computer on which the Web browser is running,
- The communication system response time,
- The amount of data to be refreshed on the page.

Monitoring Menu

The “Monitoring” menu contains the two following items:

- A link to the “**Altivar viewer**” page:

The state indicated in the “Altivar State” field corresponds to the display on the drive integrated display terminal. A delay may sometimes be noticed between the displays on the Web server and the display terminal, depending on the performance of the computer used to display the pages using a Web browser and the communication system performance.

The motor speed displayed on the “Motor Speed” gauge is calibrated according to the maximum frequency **[Max Frequency]** (f_{max}) and the number of pairs of poles **[Poles pair number]** ($P P n$).

The LI... area gives the state of the drive terminals (logic inputs LI1 to LI16, logic outputs LO1, relay outputs R1 to R2, analog inputs AI1 to AI3 and analog output AO1). When a logic input is active, the LED is green. When a logic output is active, the LED is red.

- A link to the “Drive parameters” page:

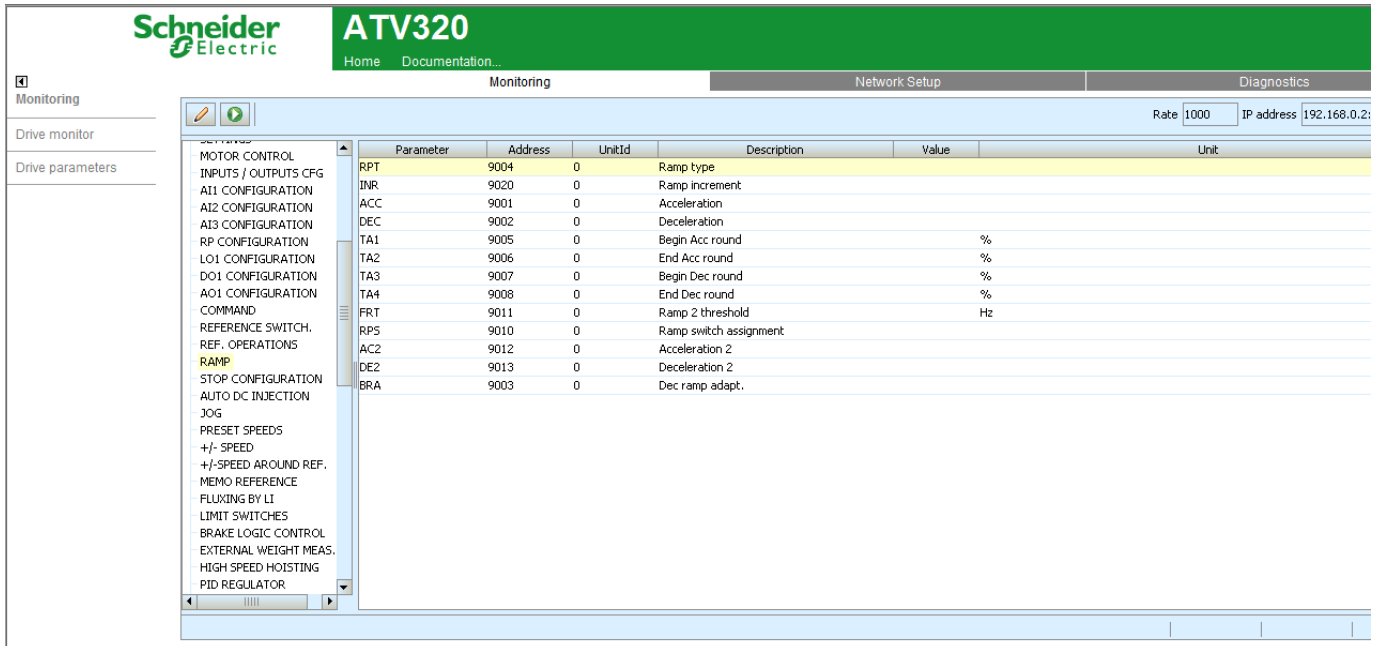

This page is used to display the drive parameters and to modify their values.

The parameters are arranged in groups, and are consistent with the keypad and user manuals.

The display mode for each value depends on the nature of the parameter:

- The unit for the physical values is displayed in the “Unit” column.
- The registers (bit fields) are displayed in hexadecimal format (16#xxxx).
- Signed values are displayed as such.

To begin the monitoring, click on the “Start animation” button:

To modify the parameter value, click on the “Write value of selected row” button then select the parameter to modify.

It is only possible to modify the parameter values after entering the “Write password” (see “Access Rights - Password and User Names” on page 108). Click on the “Password” button to enter this password. An entry field then appears in the parameter table, and also a “Cancel” button, for cancelling the password entry. After entering the password, press the Enter key so that it is taken into account by the Web browser.

When the value of a parameter cannot be modified, the following warning appears: “This parameter can't be written!”.

This is the case for all parameters until you have correctly entered the Password.

If I/O Scanning has been enabled, modifying the value of a parameter assigned to periodic output variables will have no effect since this value is updated cyclically by the PLC. The same applies if a parameter is written periodically by a Modbus service.

Network Parameters

Modbus Scanner

This page is used to:

- Enable or disable I/O Scanning.
- Display and modify assignment of the I/O Scanning periodic variables.
- Set the communication monitoring time out.

	Config	Addr	Description		Config	Addr	Description
1	CMD	8501	Command word	1	ETA	3201	Status word
2	LFR	8502	Frequency setpoint	2	RFR	3202	Output frequency
3	-0-			3	-0-		
4	-0-			4	-0-		
5	-0-			5	-0-		
6	-0-			6	-0-		

All modifications are protected by the “Write password” modification password.

Click on the “PassWord” button to enter the “Write password”.

After correctly entering the password, you can access “I/O scanner”, “Time Out (s)”, “Master”, “Output parameters”, “Input parameters” and the “Save” and “Abort” buttons.

By default, the password is “USER”. It can be modified in the “Data write password” page.

Enabling I/O Scanning

Control by the I/O scanner is enabled if the “I/O scanner” field is at the value “Yes” and is disabled by the value “No”.The “I/O scanner” field corresponds to the parameter [\[Eth IO scan act\] \(I O S A \)](#).

NOTE: Disabling I/O Scanning results in loss of control if a PLC is using an I/O scanner.

Before disabling I/O Scanning, you must disable the time out (set the value to 0). However, communication monitoring remains active and the card triggers a communication detected fault at the end of the period defined by the time out. In factory settings mode, the drive then changes to [\[Fieldbus Com Interrupt\] \(E n F \)](#) error.

Once the value in the “I/O scanner” field has been modified, it may take a while to update the page, depending on the capacity of your computer.

The “I/O scanner” field corresponds to the parameter [\[Eth IO scan act\] \(I O S A \)](#).

Assigning the I/O Scanning periodic variables

NOTE: Modifying the assignment of the periodic variables can result in loss of control if a PLC is using an I/O scanner.

To modify the I/O Scanning periodic variables, proceed as follows:

- Enter “No” in the “I/O scanner” field.
- Modify the assignment of periodic variables.
- Apply these modifications using the “Save” button.
- Enter “Yes” in the “I/O scanner” field.

Once the value in the “I/O scanner” field has been set to “No”, it may take a while to update the page, depending on the capacity of your computer. A dropdown menu is used to modify the assignment of each of the periodic variables.

Click on the periodic variable whose assignment you wish to modify, then choose the code corresponding to the drive parameter to be assigned. The parameter can be chosen from the drop down list or directly entered with its Modbus address.

All modifications to “Output parameters” and/or “Input parameters” can be confirmed by clicking on the “Save” button or canceled by clicking the “Abort” button.

Each time the “Save” button is pressed, the address table will be saved to an EEPROM on the Ethernet card. The assignments are now saved, even if the power is turned off.

MODBUS TCP Scanner configuration

IO Scanner Active: OFF | IP Master: 0.0.0.0 | Modbus Timeout: 20

	Config	Addr	Description		Config	Addr	Description
1	CMD	8501	Command word	1	ETA	3201	Status word
2	LFRD	8602	Speed setpoint	2	RFRD	8604	Output velocity
3	.-	0	Not assigned	3	.-	0	Not assigned
4	.-	0	Not assigned	4	.-	0	Not assigned
5	.-	0	Not assigned	5	.-	0	Not assigned
6	.-	0	Not assigned	6	.-	0	Not assigned

Buttons: Save, Abort, Password

Master

To configure reservation, enter an IP address other than **[0.0.0.0]** in the “Master” field. This field is equivalent to the **[IP Master] (, P P -)** parameter.

Time out

This page can also be used to modify the communication monitoring “time out”. All entries must be confirmed by pressing “Enter”.

The accepted values are as follows:

- 0: No communication check.
- 0.5 to 60.0 s: Time out value.

See “Configuring Communication Detected Fault Management” on page 49. The default time out value is 2 s (display: “2.0”).

The “Time Out” field corresponds to the **[time out] (t o u t)** parameter.

EtherNet/IP Scanner

EtherNet/IP Scanner configuration

Assembly 100			Assembly 101				
	Config	Addr	Description		Config	Addr	Description
1	CMD	8501	Command word	1	ETA	3201	Status word
2	LFRD	8602	Speed setpoint	2	RFRD	8604	Output velocity
3	.0.	0	Not assigned	3	.0.	0	Not assigned
4	.0.	0	Not assigned	4	.0.	0	Not assigned
5	.0.	0	Not assigned	5	.0.	0	Not assigned
6	.0.	0	Not assigned	6	.0.	0	Not assigned

Buttons: Save, Abort, Password

A dropdown menu is used to modify the assignment of each of the periodic variables.

Click on the periodic variable whose assignment you wish to modify, then choose the code corresponding to the drive parameter to be assigned.

The parameter can be chosen from the drop down list or directly entered with its Modbus address.

All modifications to “Output parameters” and/or “Input parameters” can be confirmed by clicking on the “Save” button or canceled by clicking on the “Abort” button.

NOTE: These modifications will be taken into account when the power is switched off /on.

Each time the “Save” button is pressed the address table will be saved to an EEPROM on the Ethernet card. The assignments are now saved, even if the power is turned off.

Fast Device Replacement

This page displays the main parameters used by the VW3A3616 Ethernet card FDR function and is used to configure these parameters. See the “FDR Service” chapter in this section for more information.

Fast device replacement

FDR configuration		FDR status	
FDR Server	0.0.0.0	Device Name	
FDR State	3: Ready	Device File	NA
FDR Validation	OFF	Device Reference	ATV320U07N4C
Local Config	OFF	IP Address	192.168.0.2
FDR Error mgt.	OFF	Net Mask	255.255.255.0
Autosave	OFF	Gateway	0.0.0.0
Period (minute)	0	Error Code	0: No fault
Buttons: Save, Restore		Save Counter	0
		Restore Counter	0
		Delete Counter	0
		Buttons: Save file, Restore file, Delete file, Counters reset, Password	

Administration

This page is used to modify the Web read and the web write password. See "Access Rights - Password and User Names" on page 108.

TCP/IP Statistics

This page gives detailed information about the Ethernet status and settings.

TCP/IP parameters		Status	
IP Address	192.168.0.2	Link Status (right/B port)	Link down
Subnet mask	255.255.255.0	Link Status (left/A port)	100BaseTX-FD
Default gateway	0.0.0.0	Receive statistics	
IP Mode	Manual	Frames received OK	3402
Ethernet parameters		CRC errors	0
MAC Address	00-80-F4-D6-17-13	Transmit statistics	
Ethernet frame format	Ethernet II	Frames transmitted OK	3264
Data rate (right/B port)	Link down	Collisions	0
Data rate (left/A port)	100 Mbps	Carrier sense errors	0
		Excessive collisions	0
		Late collisions	0

Modbus Messaging Statistics

This page gives detailed information about the Modbus server.

Inbound / Outbound statistics		IO Scanner statistics	
Opened TCP connections	1	IO scans received	0
Sent Modbus msg	10266	IO scans transmitted	0
Received Modbus msg	10266	Error messages	0
		IO scan errors	0

EtherNet/IP Statistics

This page gives detailed information about the status and the CIP* settings.



ATV320

Home Documentation...

Monitoring

Network Setup

Diagnostics

Diagnostics

Ethernet IP statistics

TCP/IP statistics

Modbus statistics

Ethernet IP statistics

Connection diagnostic		Explicit Messaging diagnostic	
Max CIP IO Connections opened	0	Class3 Msg Send Counter	0
Current CIP IO Connections	0	Class3 Msg Receive Counter	0
Max CIP Exp Connections opened	0	UCMM Msg Send Counter	0
Current CIP Exp Connections	0	UCMM Msg Receive Counter	0
CIP Connection Opening Errors	0	Bandwidth diagnostic	
CIP Connection Timeout Errors	0	Current sending Urgent prio rate (pkt/s)	0
Max EIP TCP Connections opened	0	Current reception Urgent prio rate (pkt/s)	0
Current EIP TCP Connections	0	Current sending Scheduled prio rate (pkt/s)	0
IO Messaging diagnostic		Current reception Scheduled prio rate (pkt/s)	0
IO Production Counter	0	Current sending High prio rate (pkt/s)	0
IO Consumption Counter	0	Current reception High prio rate (pkt/s)	0
IO Production Send Errors Counter	0	Current sending Low prio rate (pkt/s)	0
IO Consumption Receive Errors Counter	0	Current reception Low prio rate (pkt/s)	0
		Current sending Explicit rate (pkt/s)	0
		Current reception Explicit rate (pkt/s)	0

Reset counters

CIP: Common Industrial Protocol

FTP Server

Access

- Access the embedded Web server resource files.
- Store the FDR (Faulty Device Replacement) service configuration files.

Access to the FTP server is protected. To access it, the user has to enter a user name and a password:

- The user name is USER.
- The default HTTP password is USER. It can be changed by the standard Web server.

Address format in Internet Explorer: **ftp://USER:USER@xxx.xxx.xxx.xx**



Restrictions:

- The “FDR” folder is “fixed” and cannot be removed.
- The file names can be up to 48 characters long (maximum).

SNMP Agent

The VW3A3616 is compliant with SNMP V1.0.

Supported Functions

Objects	Description	Access	Default Value
SysDescr	Text description of the product	RO	Schneider Electric Altivar Fast Ethernet TCP/IP Module
SysObjectID	Points in the private MIB on the product reference	RO	1.3.6.1.4.1.3833.1.7.255.6
SysUpTime	Time elapsed since the last power up	RO	Managed by the option
SysContact	Information allowing to contact the node manager	R/W	" "
SysName	Node administrative name	R/W	“ATV” or FDR device name if configured
SysLocation	Physical location of the product	R/W	" "
SysService	Indicates the service type offered by the product.	RO	72

Remark

- The VW3A3616 manages the following PDU: GET, GetNext, Set. it does not manage the PDU “TRAP”.
- A SET with a too big size generates a standard detected error named: “tooBit (1)”
- Trying to access other objects must return “noSuchName (2)”.

Integration in the EtherNet/IP Network

16

What's in this Chapter?

This chapter contains the following topics:

Topic	Page
Installing the EDS File	119
Configuration of the EtherNet/IP Module in the Rockwell PLC	121
Configuring the Implicit Exchanges	122
Configuration of the Communication Scanner	124
Configuration of the Communication Period	125
Explicit Messaging	126
Assembly Selection	128

Installing the EDS File

The EDS file of the VW3A3616 communication card can be downloaded from www.schneider-electric.com. To install the new EDS file, you can launch the EDS wizard from the Tools entry of RS-Networx menu.

Select "register an EDS file":

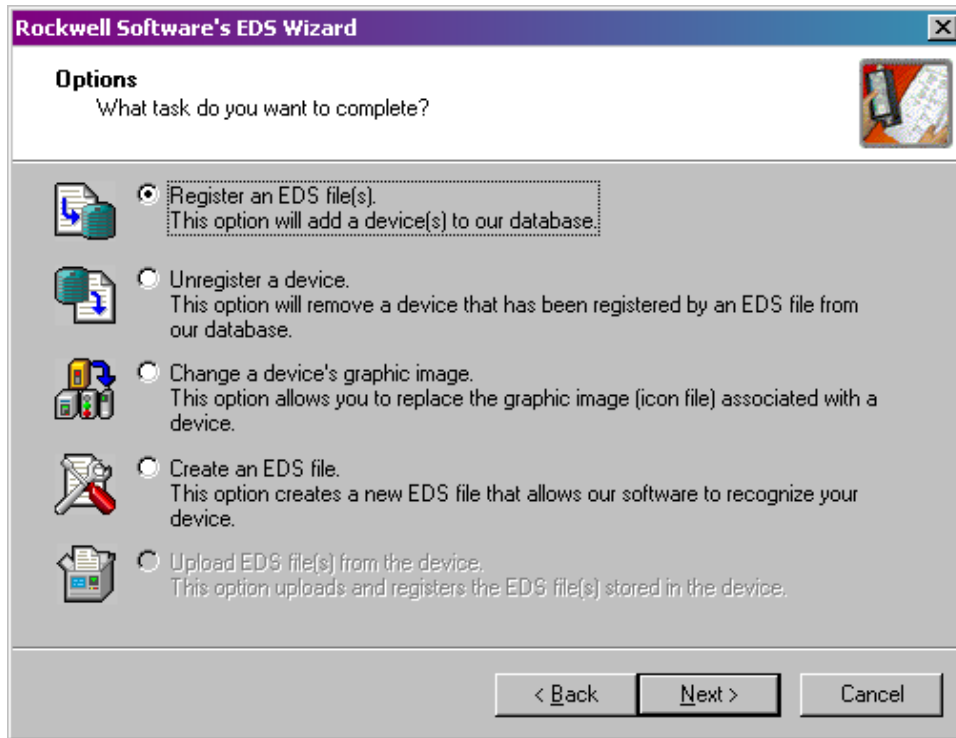

Click "Next" button.

Select the location where the EDS file has been recorded:

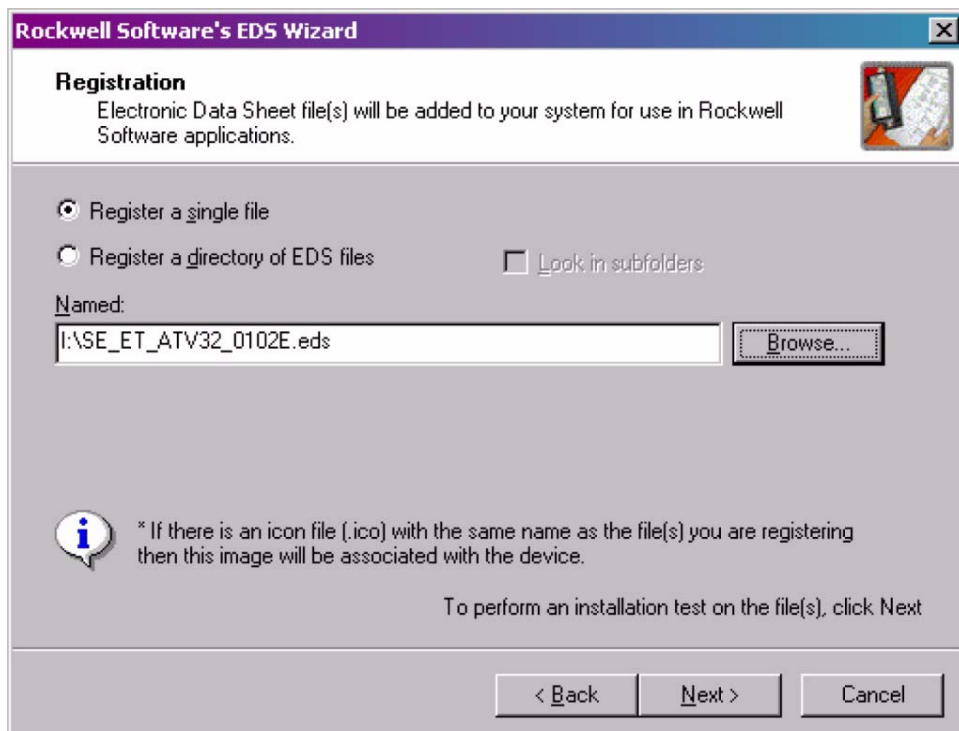

Click "Next" button.

You should get the following result, that indicates that the EDS file has been successfully imported:

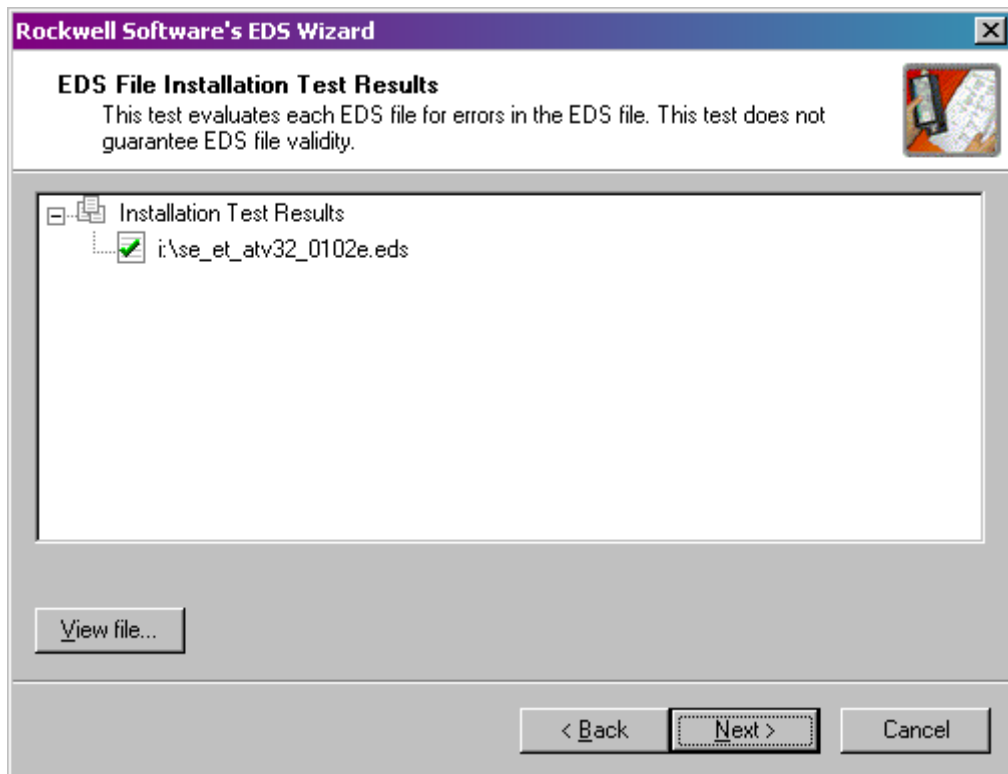

Click "Next" button.

When selecting "Next" the wizard will propose you to change the icon picture associated to the device. If you don't need to change the icon file click "Next" button to terminate the EDS registration.

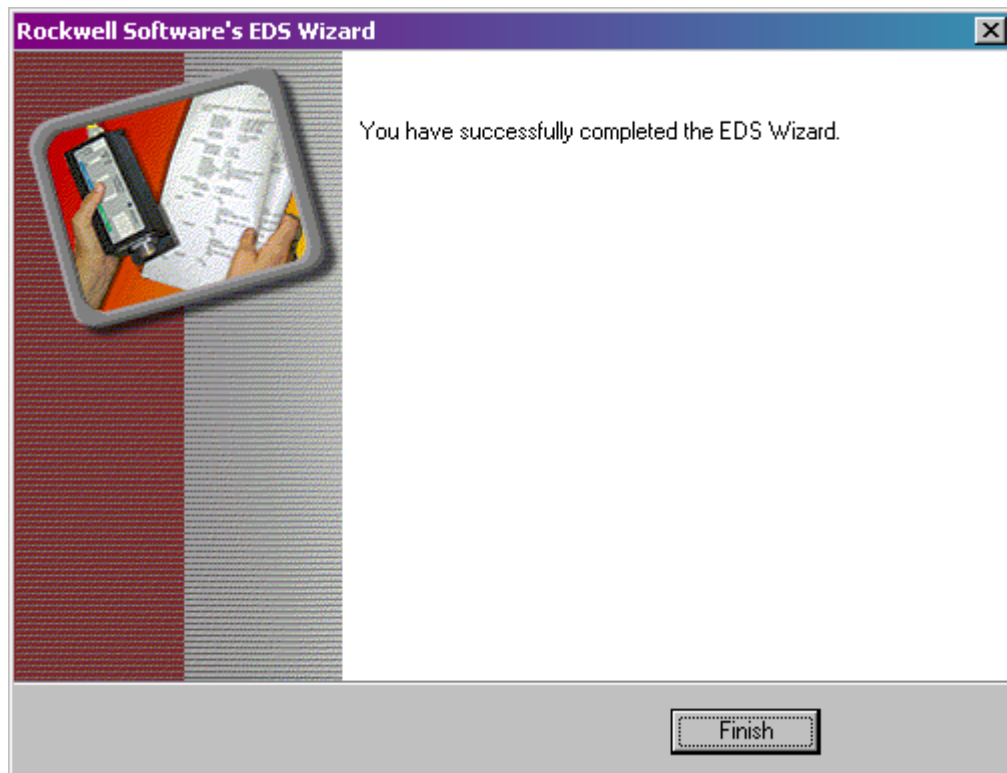

Configuration of the EtherNet/IP Module in the Rockwell PLC

In the example below, the module is installed in the first slot of the local base plate of a 1756 CPU:

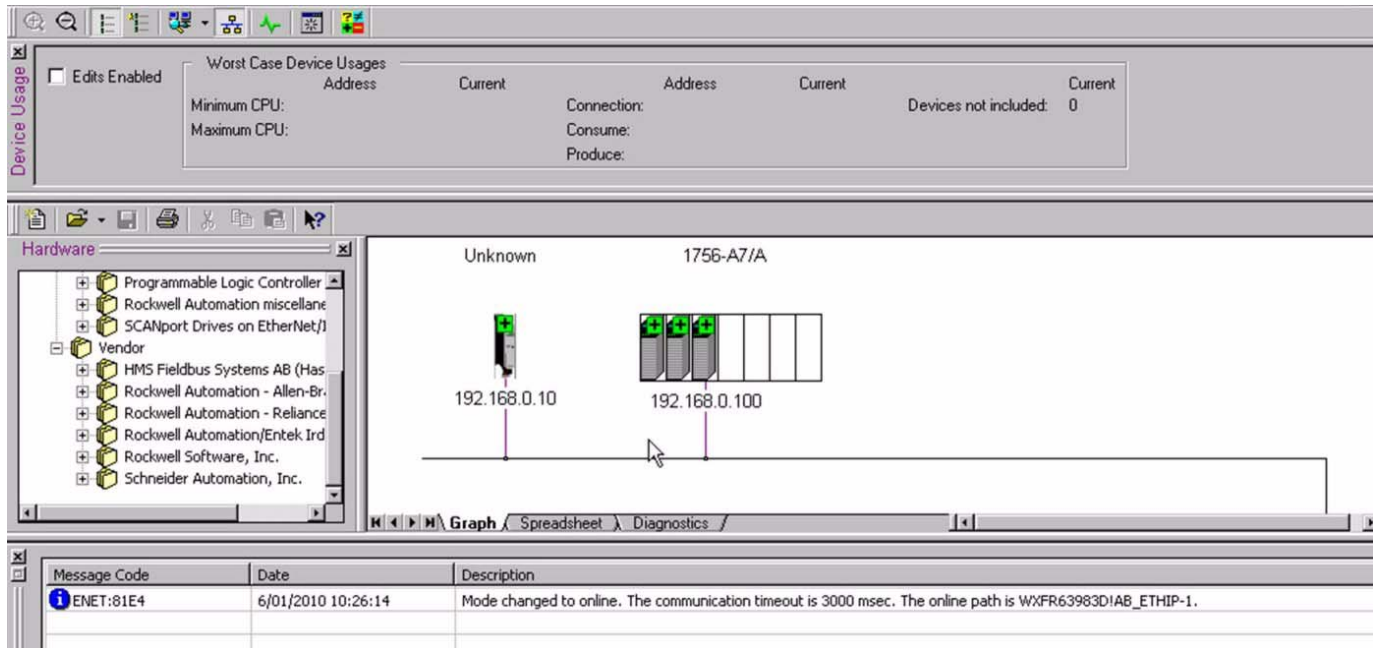

The VW3A3616 module is identified with the symbol: Generic Module. This identifier will be used later with tools such as the Class Instance editor.

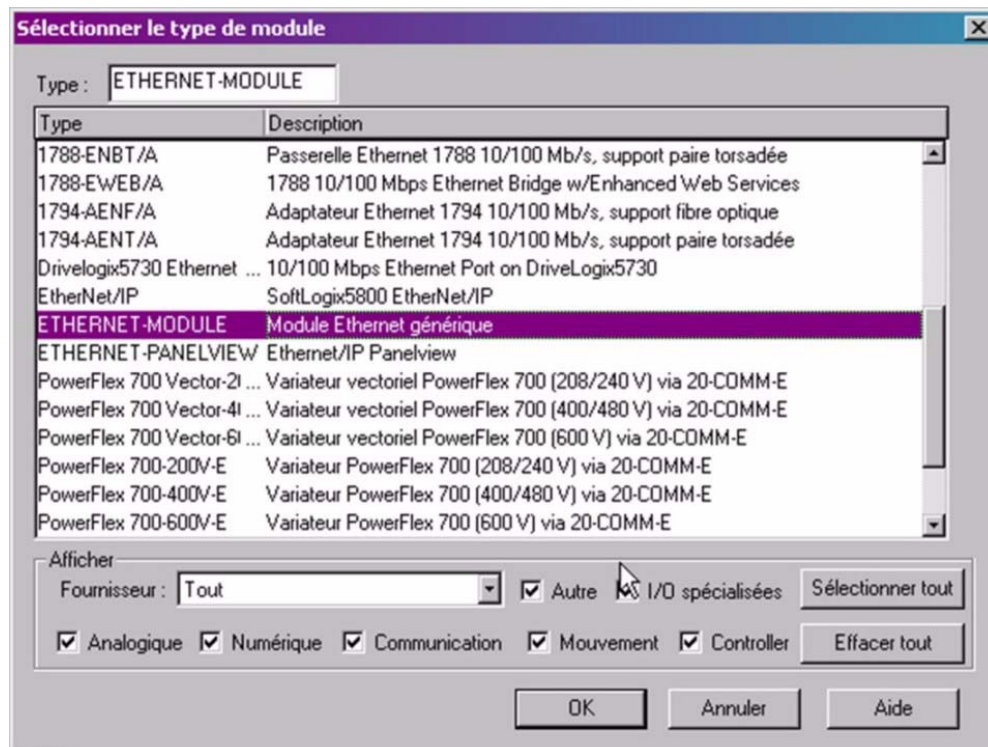

Configuring the Implicit Exchanges

The ATV320 allows the use of 3 assemblies set as described in previous chapter. In the example we have selected the assemblies 100 and 101 are relative to the ATV320 native Profile (CiA402 velocity mode).

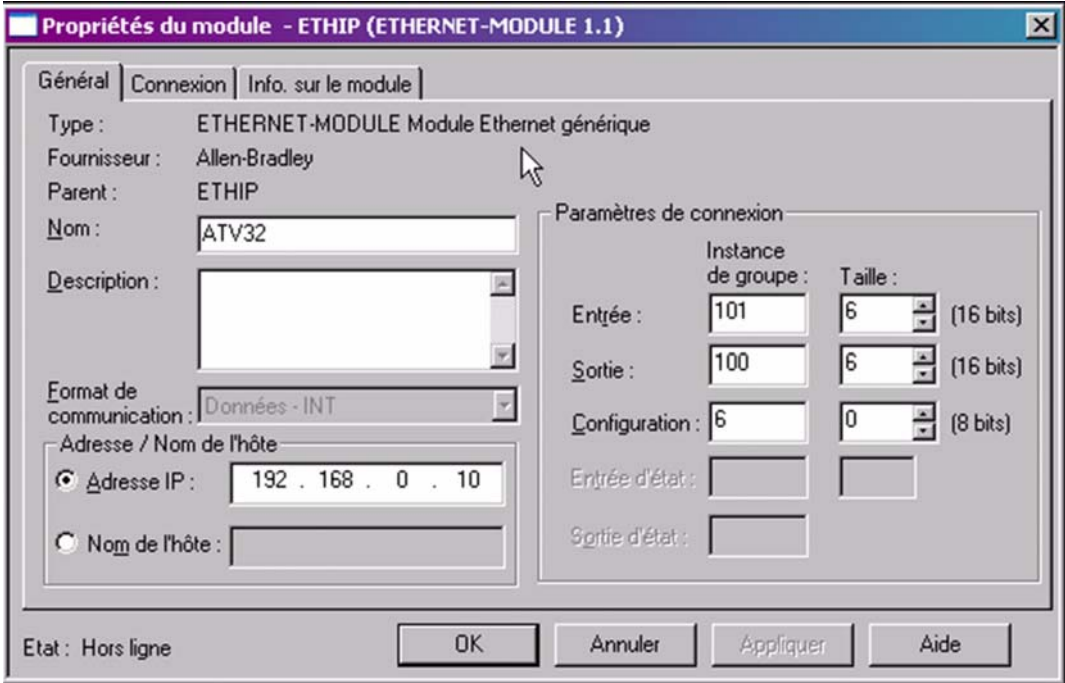

Once configured, the data objects are automatically updated and linked with the implicit exchanges mechanism:

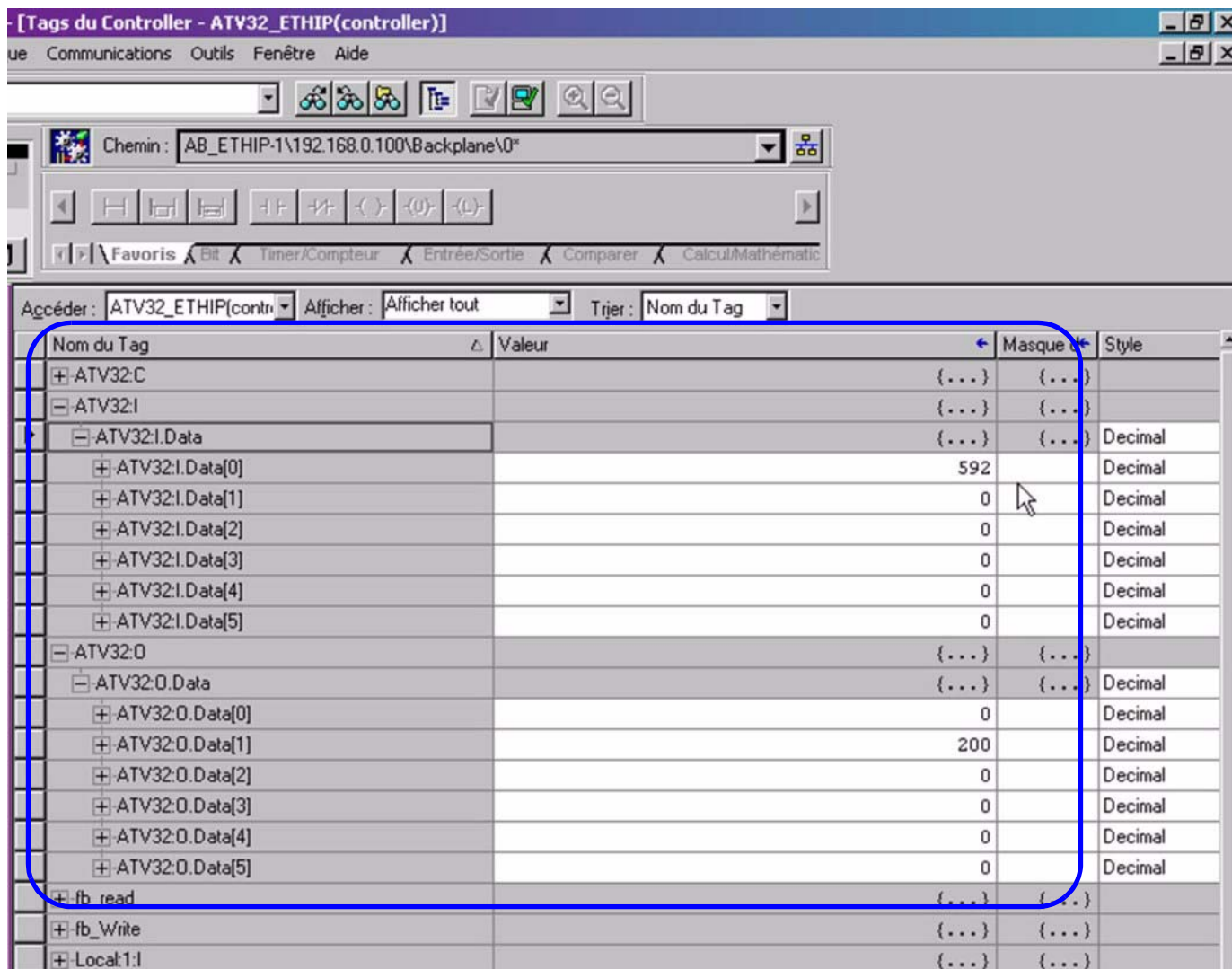

The assemblies are linked to the Option card communication scanner - see relative chapter - the example is based on the default values of the communication scanner.

I/O	PLC data	ATV320 parameter	Linked to: (Through Communication scanner)
Input	ATV320:I.Data[0]	(o P R 1)	(E L R)
	ATV320:I.Data[1]	(o P R 2)	(r F r d)
Output	ATV320:O.Data[0]	(o C R 1)	(C P d)
	ATV320:O.Data[1]	(o C R 2)	(L F r d)

Configuration of the Communication Scanner

The communication scanner is accessible via the following menus: **[Communication]** (*C o m -*) and **[Communication Module]** (*c b d*) submenus.

The 6 output variables and the 6 input variables are assigned by means of parameters (*o C A 1*) to (*o C A 6*) and (*o P A 1*) to (*o P A 6*). An (*o C A x*) or (*o P A x*) parameter with a value of zero is not linked to a parameter in the drive.

These 6 parameters are described in the table below.

(*o C A x*) or (*o P A x*) defines the addresses.

[Scan.Out1 address]	(<i>o C A 1</i>)	(<i>E P d</i>)
[Scan.Out2 address]	(<i>o C A 2</i>)	(<i>L F r d</i>)
[Scan.Out3 address]	(<i>o C A 3</i>)	0
[Scan.Out4 address]	(<i>o C A 4</i>)	0
[Scan.Out5 address]	(<i>o C A 5</i>)	0
[Scan.Out6 address]	(<i>o C A 6</i>)	0
[Scan.IN1 address]	(<i>o P A 1</i>)	(<i>E t A</i>)
[Scan.IN2 address]	(<i>o P A 2</i>)	(<i>r F r d</i>)
[Scan.IN3 address]	(<i>o P A 3</i>)	0
[Scan.IN4 address]	(<i>o P A 4</i>)	0
[Scan.IN5 address]	(<i>o P A 5</i>)	0
[Scan.IN6 address]	(<i>o P A 6</i>)	0

Configuration of the Communication Period

In the module properties dialog box, you must also define the period for the implicit exchanges.

NOTE: This is also used for monitoring the connection. The option will time-out its connexion after a fixed time which is defined by 3 X RPI period (Requests packet Interval), only for Rockwell automat.

Example

RPI = 20ms. Time out occurs after 60ms if no implicit exchanges are requested by the scanner.

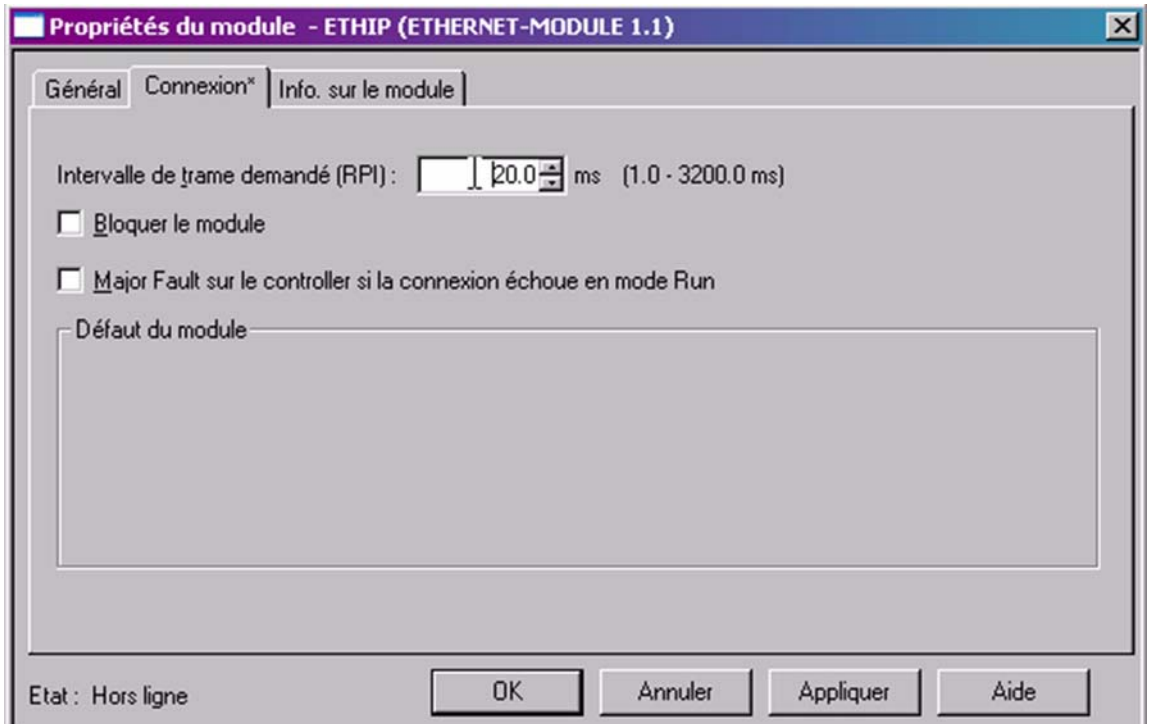

Explicit Messaging

By using the MSG function of the PLC, it is possible to get or set the value of the parameters. The access to the parameters is obtained by the use of the CIP addresses.

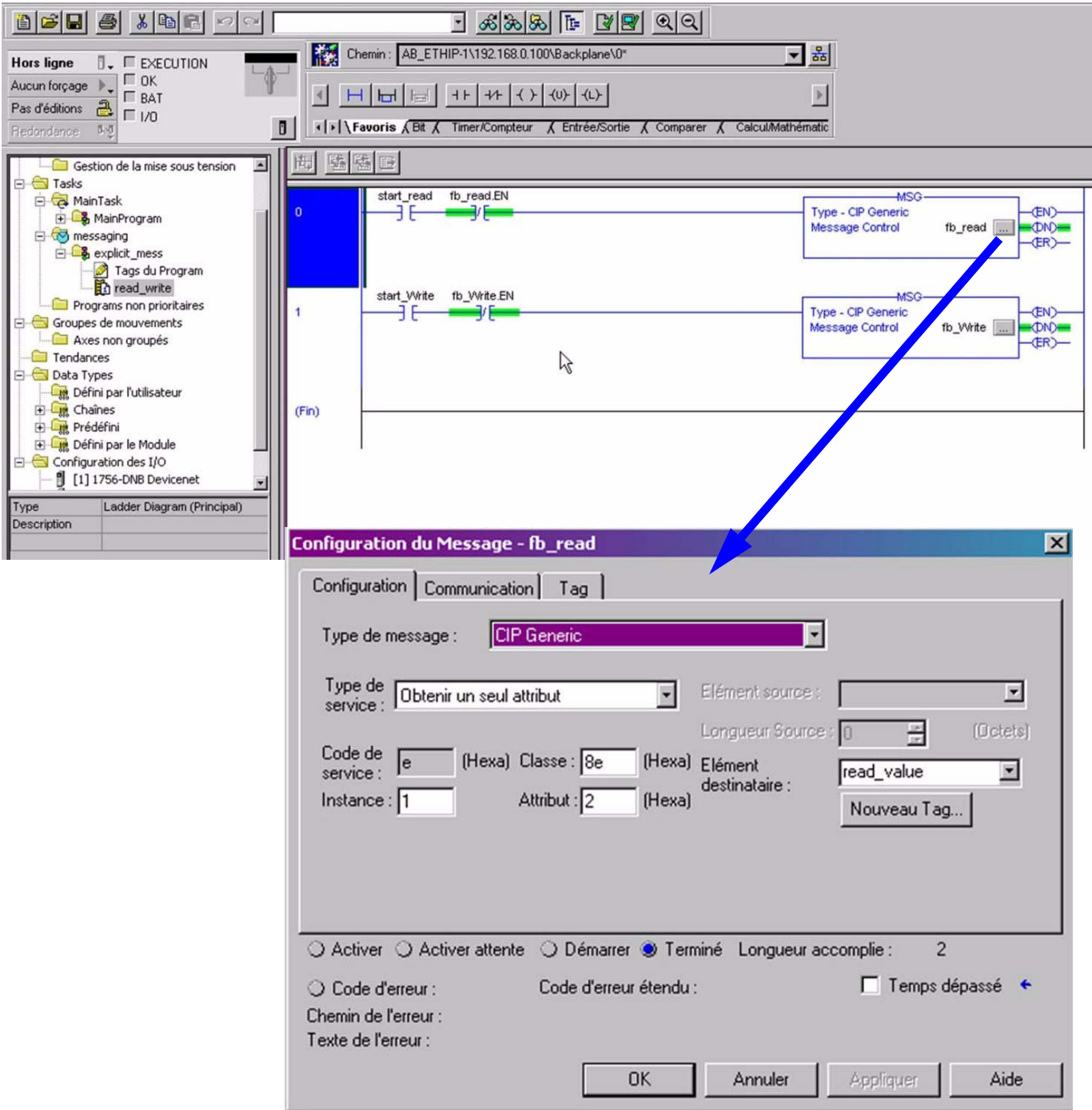

Then define the Path to the device:

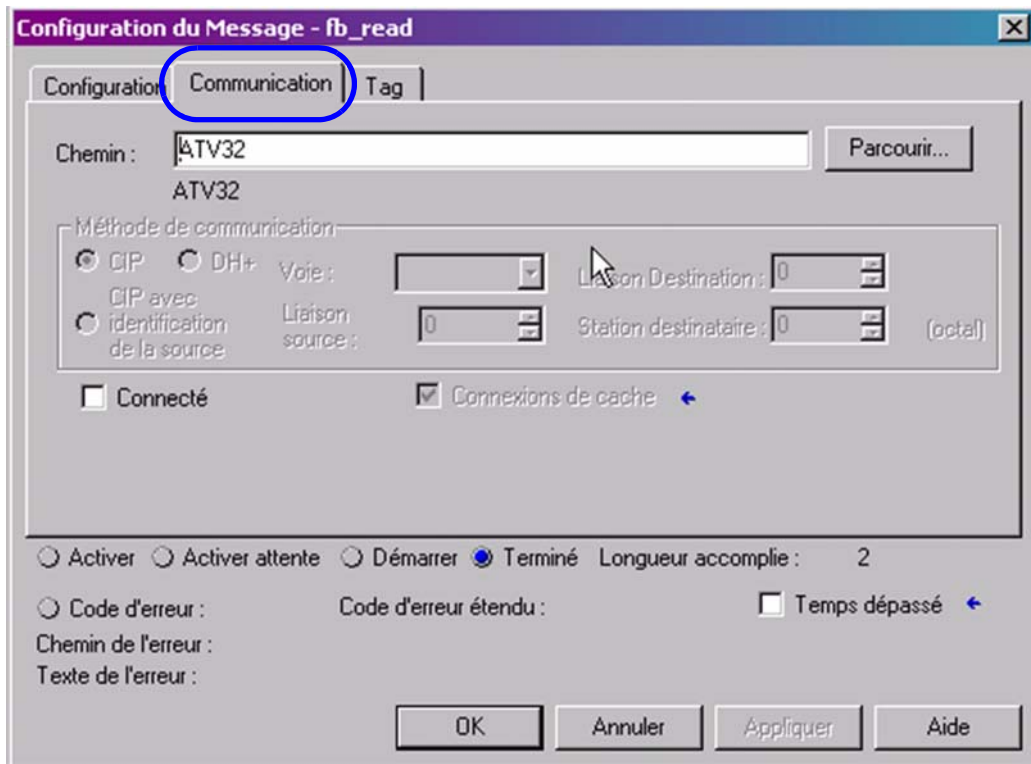

Assembly Selection

The choice of the assembly set should be done from the PLC, by applying the required assembly number to the following objects:

- Output assembly: 5/0/64
- Input assembly: 5/0/65

The default setting of these assemblies is 100 and 101.

It is recommended to set by program (when PLC starts) the assemblies needed for the application.

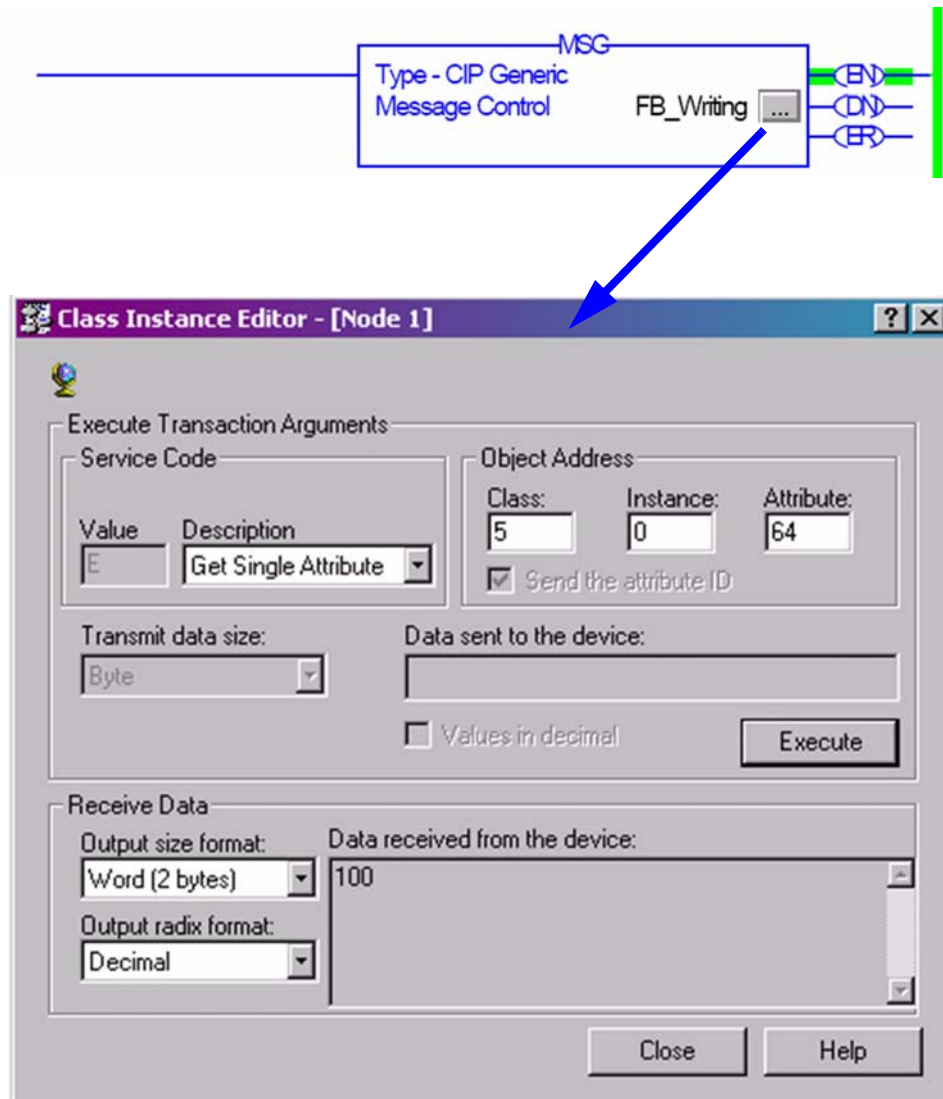

Software Setup with SoMachine (M251)

17

What's in this Chapter?

This chapter contains the following topics:

Topic	Page
Introduction	130
Drive Configuration	131
Ethernet Master Configuration	132

Introduction

Overview

In the following example

- Drive is connected to the M251MESE
- Communication protocol used is EtherNet/IP
- You can control the drive directly via SoMachine

Note: The version of SoMachine used is V 4.2



Drive Configuration

Overview

In the following example, the drive configuration must be done as follows in-order to establish communication between the drive and the PLC.

You can configure the drive using the

- Graphical Display Terminal
- DTM via the SoMachine container

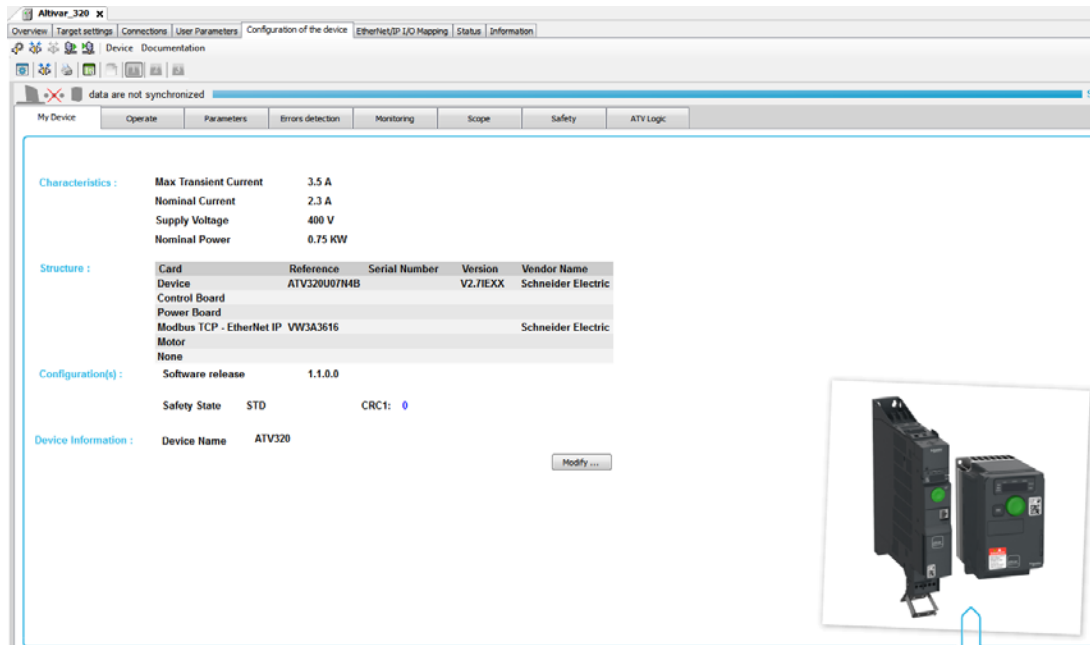

Factory Settings

Before configuring the drive, make sure that you reset the drive to factory settings

Go to

- **[Drive menu]** (*d r i -*) menu, **[Configuration]** (*C o n F -*) submenu,
- **[Factory settings]** (*F C S -*) submenu

Then configure the following parameters

- **[Parameters group list]** (*F r Y -*) to **[All]** (*A L L*)
- **[Go to Factory Settings]** (*G F S*) to OK

Command Configuration

To control the drive with an Ethernet master, select Ethernet as active command channel

Go to

- **[Drive menu]** (*d r i -*) menu, **[Configuration]** (*C o n F -*) submenu,
- **[Full]** (*F u L L -*) menu
- **[Command]** (*C t L -*) menu

Then configure

- **[Ref Freq 1 Config]** (*F r I*) parameter to **[Ref. Freq-Com. Module]** (*n E t*) value

Communication Configuration

To set the Ethernet address of the drive, go to:

- **[Communication]** (*C o m -*) menu
- **[Communication module]** (*C b d -*) submenu

Then configure

- **[Ethernet protocol]** (*E t H n*) to value **[EthernetIP]** (*E t , P*)
- **[IP mode]** (*, P n*) to value **[Fixed]** (*n n u*)
- **[IP Module]** (*, P C*) to value 192.168.0.2
- **[IP Mask]** (*, P n*) to value 255.255.255.0

You must restart the device to take into account the modified Ethernet related parameters.

Ethernet Master Configuration

Overview

In the following example, Ethernet master is configured via SoMachine.

Master Configuration

To access the master configuration window, double click **Ethernet_2 (Device Network)**

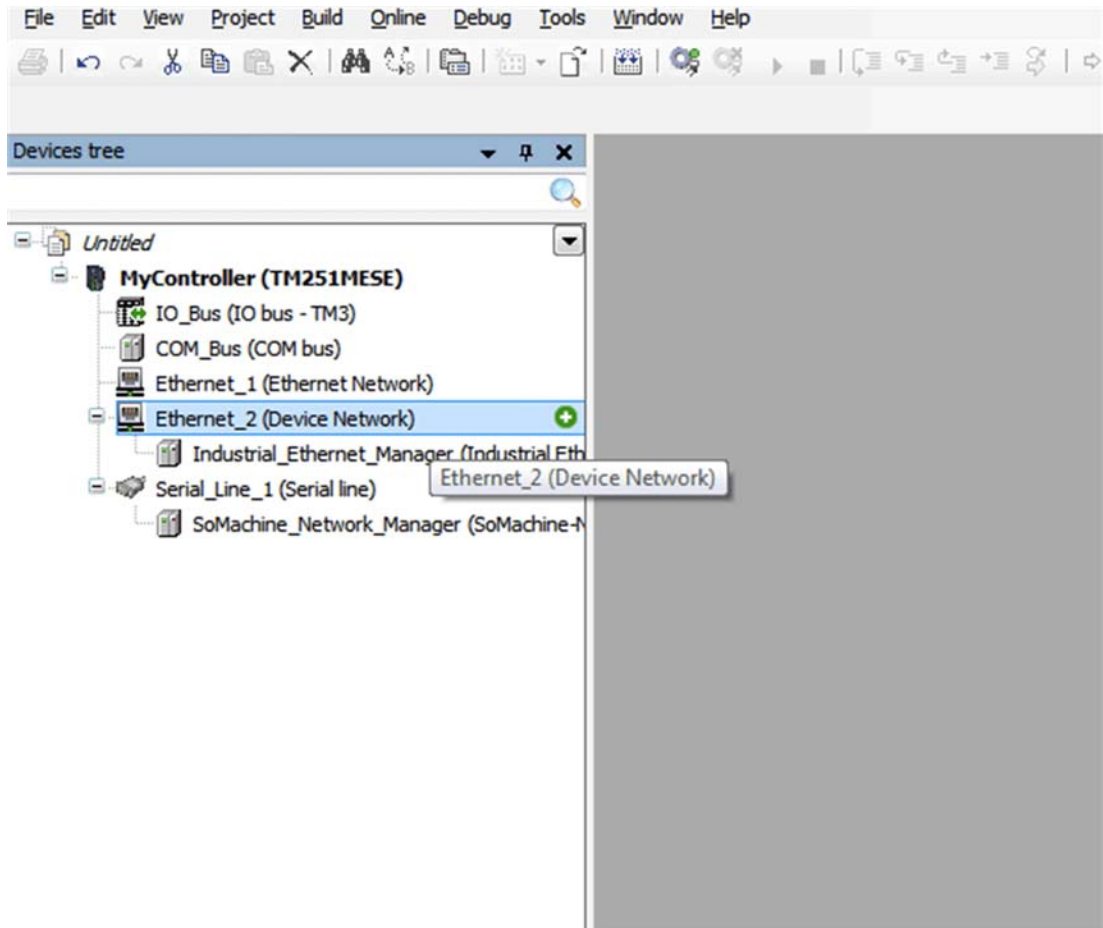

In the **Configuration** window, do the following to configure the master:

- Select **Fixed IP Address**
- In the **IP Address** box, enter 192.168.0.1 as the IP address of the master
- In the **Subnet Mask** box, enter 255.255.255.0 as the subnet mask of the master

Note: Other parameters are linked to Cyber Security parameters. For more information, refer to the M251MESE documentation.

Ethernet_2 x

Configuration

Configured Parameters

Interface Name

Network Name

IP Address by DHCP

IP Address by BOOTP

fixed IP Address

IP Address

Subnet Mask

Gateway Address

Ethernet Protocol

Transfer Rate

Security Parameters

SoMachine protocol active

Modbus Server active

Web Server active

FTP Server active

Discovery protocol active

SNMP protocol active

WebVisualisation protocol active

Slave device identification

[DHCP Server active](#)

When active, each device that will be added to the fieldbus, can be configured in order to be identified by its name or MAC Address, instead of its IP Address.

Add ATV320 Device

Right-click **Industrial_Ethernet_Manager** and then click **Add Device**

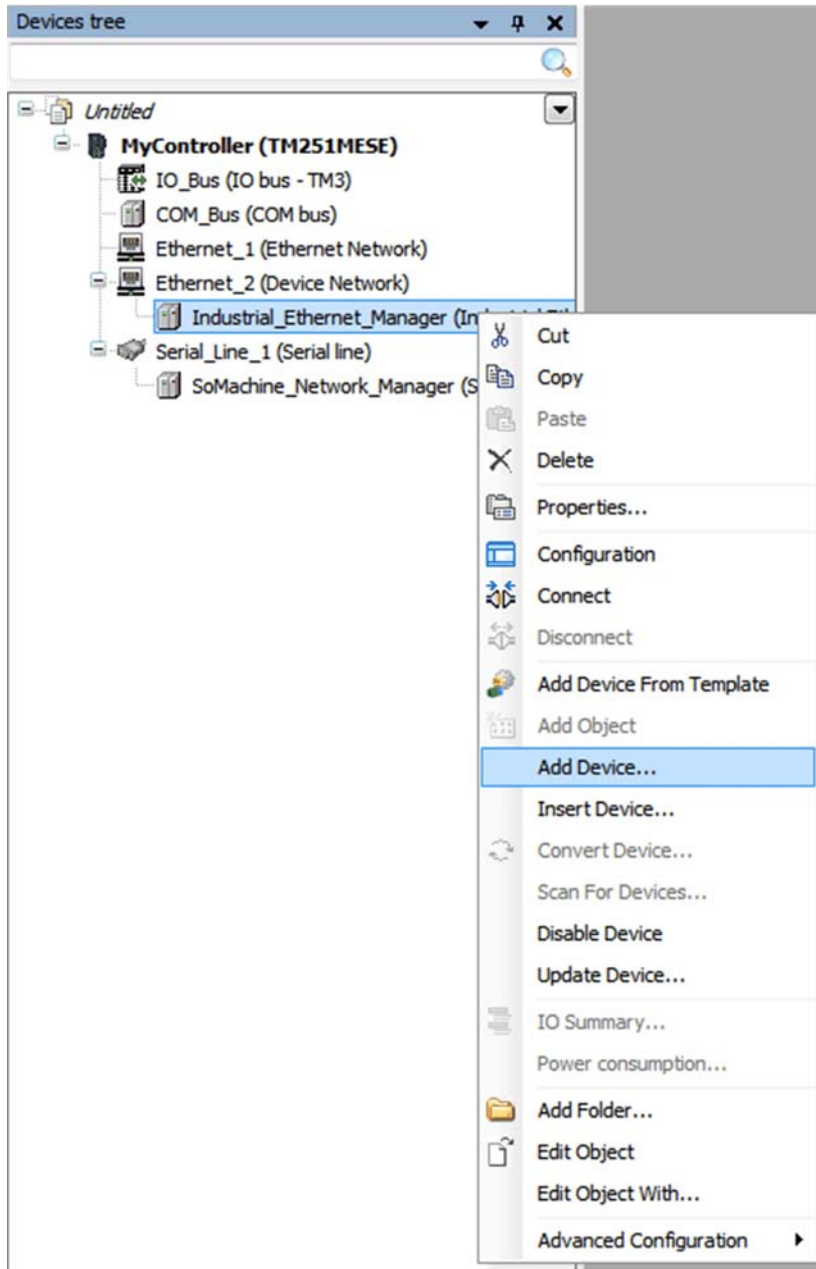

In the **Add Device** dialog box, under **Name**, select **Altivar 320**, and then click the **Add Device** button.

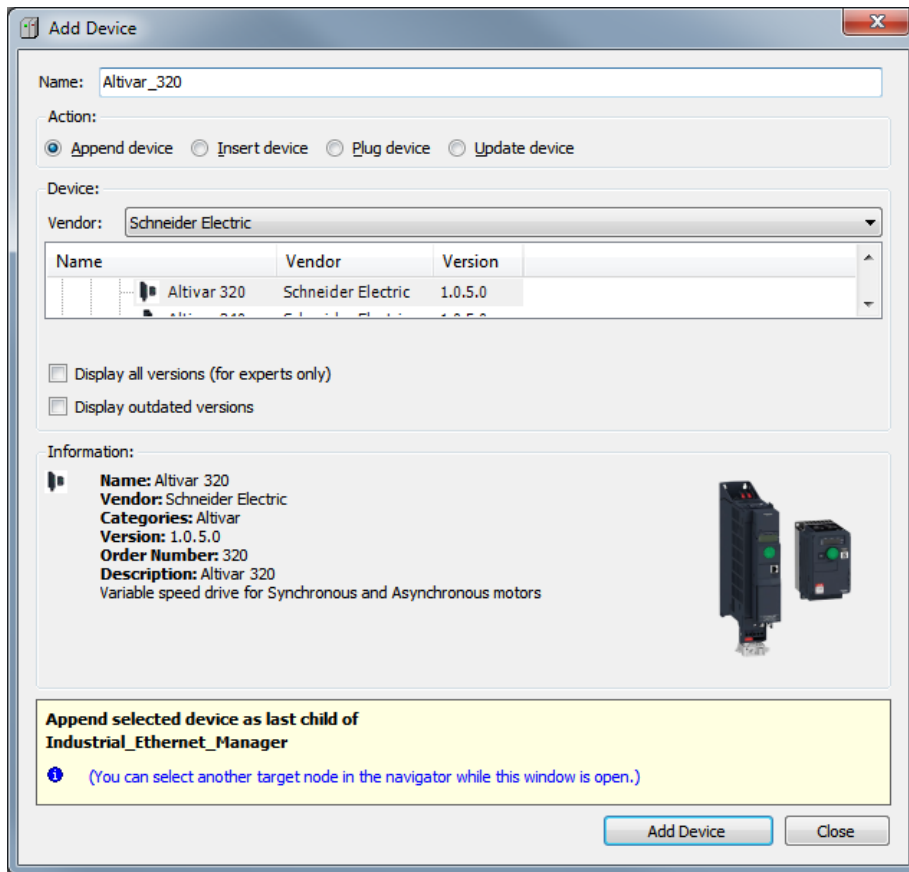

ATV320 Configuration

Double-click ATV320

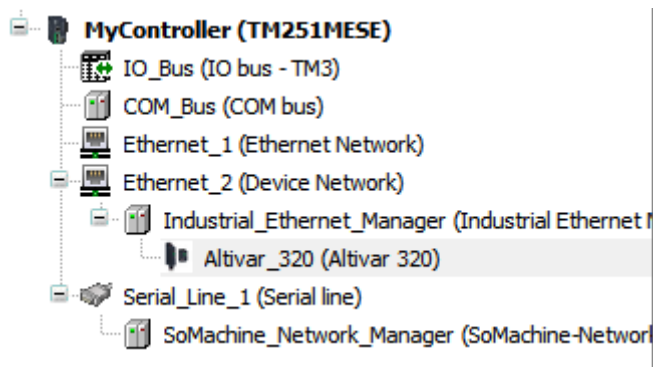

In the **Target settings** tab, configure the IP address of the device as shown in the figure.

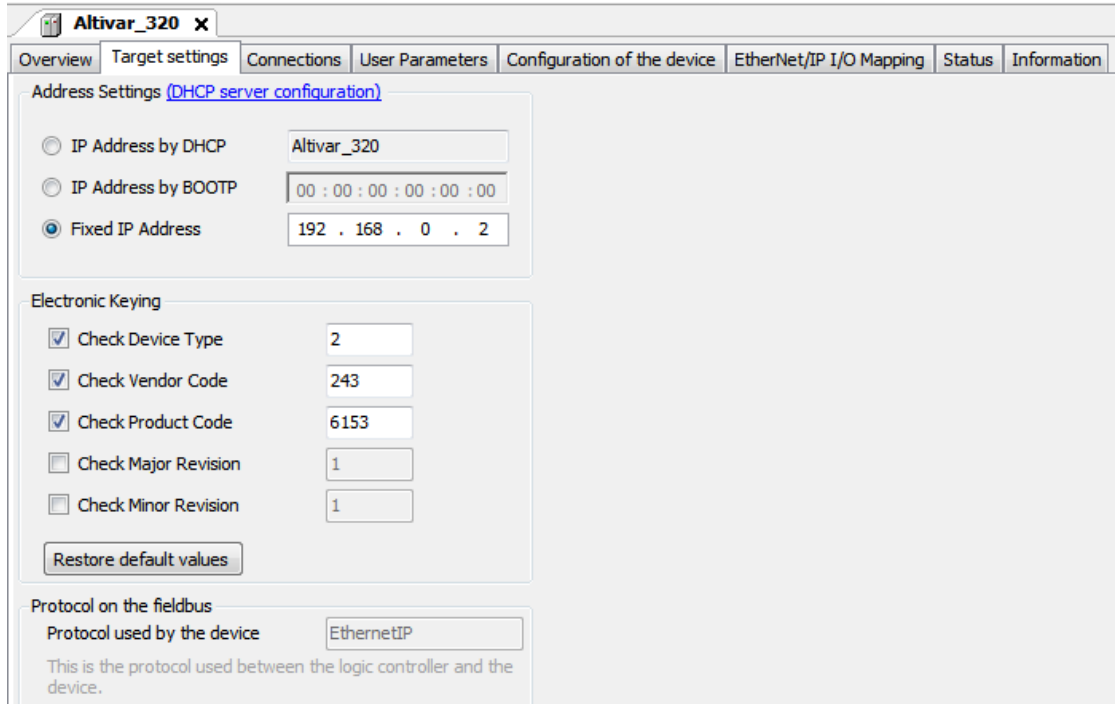

In the **Ethernet/IP I/O Mapping** Tab, inputs/output are automatically created depending on the selected assemblies (for example: assemblies 100/101)

You can give variable names and descriptions to these variables to use them in your PLC program.

The figure shows the input mapping for the selected assemblies

Variable	Mapping	Channel	Address	Type	Default Value	Unit	Description
Inputs							
ETA		Input Native Drive Control	%IW5	ARRAY...			Input Native Drive Profile
RFRD		Input Native Drive Control[0]	%IW5	WORD			Input Native Drive Profile
		Input Native Drive Control[1]	%IW6	WORD			Input Native Drive Profile
		Input Native Drive Control[2]	%IW7	WORD			Input Native Drive Profile
		Input Native Drive Control[3]	%IW8	WORD			Input Native Drive Profile
		Input Native Drive Control[4]	%IW9	WORD			Input Native Drive Profile
		Input Native Drive Control[5]	%IW10	WORD			Input Native Drive Profile

The figure shows the output mapping for the selected assemblies

Variable	Mapping	Channel	Address	Type	Default Value	Unit	Description
Outputs							
CMD		Output Native Drive Control	%QW0	ARRAY...			Output Native Drive Profile
LFRD		Output Native Drive Control[0]	%QW0	WORD			Output Native Drive Profile
		Output Native Drive Control[1]	%QW1	WORD			Output Native Drive Profile
		Output Native Drive Control[2]	%QW2	WORD			Output Native Drive Profile
		Output Native Drive Control[3]	%QW3	WORD			Output Native Drive Profile
		Output Native Drive Control[4]	%QW4	WORD			Output Native Drive Profile
		Output Native Drive Control[5]	%QW5	WORD			Output Native Drive Profile

What's in this Chapter?

This chapter contains the following topics:

Topic	Page
Supported Object Classes	138
Identity Object (F1h)	138
Message Router Object (F2h)	141
TCP/IP Interface Object (F5h)	141
Ethernet Link Object (F6h)	144
Assembly Object (04 hex)	145
Connection Manager Object (06h)	147
Motor Data Object (28h)	149
Control Supervisor Object (29h)	150
AC/DC Drive Object (2Ah)	151
Application Object (70h to C7h) / Explicit Messaging	154

Supported Object Classes

Three categories of object classes can be defined:

- CIP device on Ethernet/IP
- AC/DC drive
- VSD specific

These objects are detailed in the table below:

Object class	Class ID	Cat.	No. of instances	Effect on behavior interface
Identity	16#01	1	1	Supports the reset service
Message router	16#02	1	1	Explicit message connection
Ethernet link	16#F6	1	1	Counter and status information
TCP/IP interface	16#F5	1	1	TCP/IP configuration
Connection manager	16#05	1	1	
Motor data	16#28	2	1	Defines data for the motor connected to the device
Control supervisor	16#29	2	1	Manages drive functions, operational states, and control
AC/DC drive	16#2A	2	1	Provides drive configuration
Assembly	16#04	2	12	Defines I/O data format
Application		3	1	Vendor specific object - drive's parameters

Identity Object (F1h)

The Identity object provides identification and status information about the drive.

Class Code

Hexadecimal	Decimal
16#01	1

Class Attributes

Attribute ID	Access	Name	Data type	Value	Details
1	Get	Revision	UINT	x	Revision index of the class
2	Get	Max Instances	UINT	1	1 defined instance
3	Get	Number of Instances	UINT	1	-
4	Get	Optional attribute list	UINT	1	-
6	Get	Max ID of class attributes	UINT	7	-
7	Get	Max ID of instance attribute	UINT	17	-

Instance Attributes

Attribute ID	Access	Name	Data type	Value	Details
1	Get	Vendor ID	UINT	f(Brand)	243
2	Get	Device type	UINT	f(Brand) 00h 02h	AC/DC drive profile (02h)
3	Get	Product code	UINT	f(Brand)	16#1808
4	Get	Revision	Struct of: USINT USINT	f(Brand)	Major = High byte of (C 15 u) Minor = Low byte of (C 15 u)
5	Get	Status	WORD	-	See definition in the table below
6	Get	Serial number	UDINT	-	1st byte: 16#18 2nd...4th byte: last 3 bytes of MAC-ID
7	Get	Product name	Struct of: USINT STRING	-	ATV320

Attribute 5–Status

Bit	Definition	How
0	Owned by Master (predefined Master/Slave Connection)	No interface
2	Configured	If any of the product (option + drive) NVS attributes has changed from their default (out of box values) NOTE: Network comm attributes are not included here.
4-7	Extended device status: See below	-
8	Minor Recoverable Fault	No minor rec. fault
9	Minor Unrecoverable Fault	No minor unrec. fault
10	Major Recoverable Fault	C n F detected error or CIP connection timeout or Eth network overload
11	Major Unrecoverable Fault	r L F detected fault, eeprom failed, OB hardware detected error
Others	Reserved 0	-

Bit 4-7 Definition

Bit 4-7	Definition	How
0 0 0 0	Self testing or unknown	Not used
0 0 0 1	Firmware update in progress	Not used
0 0 1 0	At least on faulted I/O connection	-
0 0 1 1	No I/O connections established	-
0 1 0 0	Non-volatile configuration bad	Non volatile memory detected error in OB
0 1 0 1	Major fault - either bit 10 or 11 is true	Bit 10 or 11 is true
0 1 1 0	At least one I/O connection in run mode	-
0 1 1 1	At least one I/O connection established, all in idle mode	-
1 0 0 0	Reserved, shall be 0	-
1 0 0 1		
1 0 1 0 to 1 1 1 1	Vendor specific	-

Supported Class Services

Service code	Service Name	Description
01 hex	Get_Attribute_All	Read all attributes
0E hex	Get_Attribute_Single	Read one attributes

Supported Instance Services

Service code	Service Name	Description
01 hex	Get_Attribute_All	Read all attributes
0E hex	Get_Attribute_Single	Read one attributes
10 hex	Set_Attribute_Single	Write one attribute
05 hex	Reset	Perform the reset of the drive

State Diagram for the Identity Object

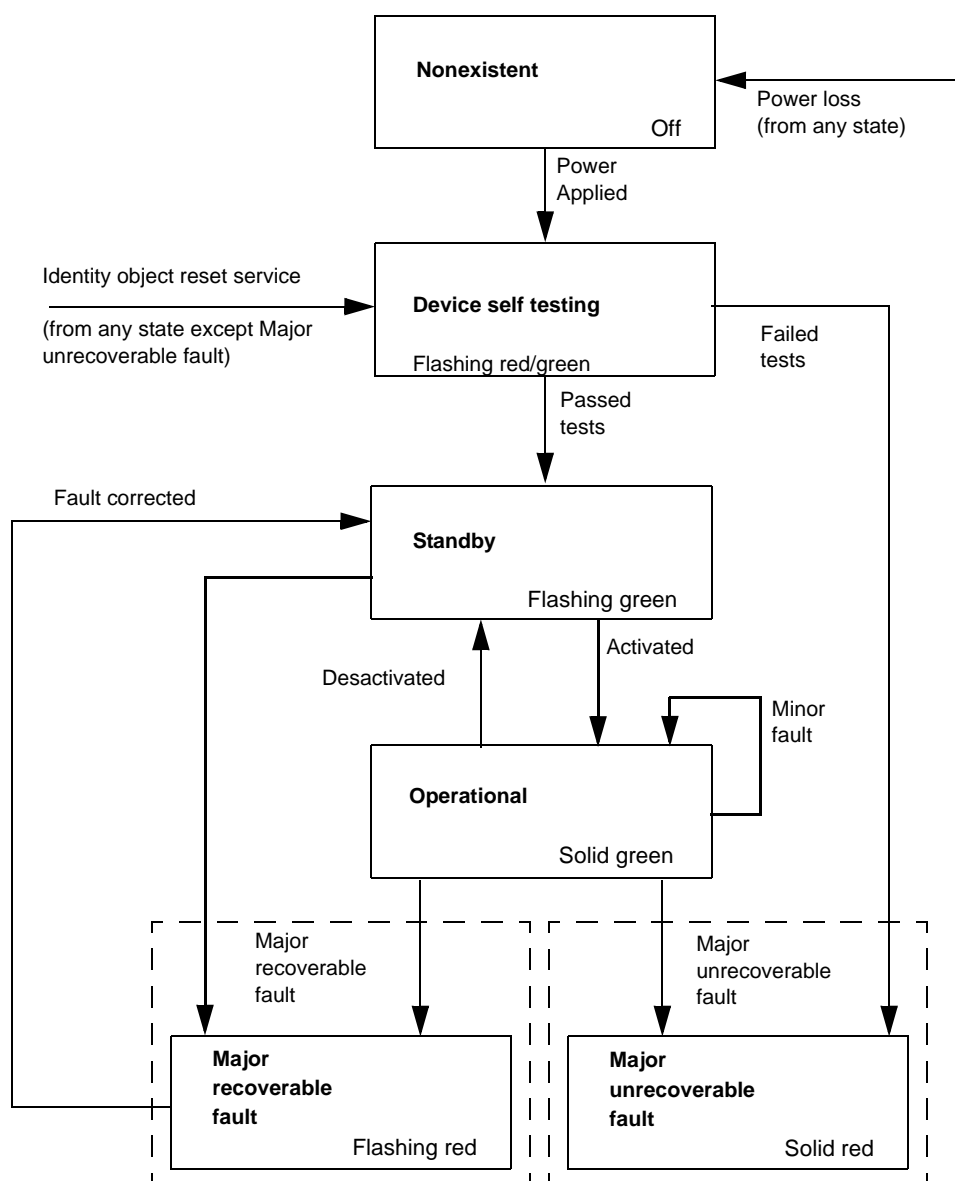

Message Router Object (F2h)

The Message router object is the element through which all the “Explicit messages” objects pass in order to be directed towards the objects they are truly destined to.

Class Code

Hexadecimal	Decimal
16#02	2

Class Attributes

Attribute ID	Access	Name	Need	Data type	Value	Details
1	Get	Revision	Opt.	UINT	X	Revision index of the class
2	Get	Max instances	Opt.	UNT	1	1 Defined instance

TCP/IP Interface Object (F5h)

Supported Class Attributes

Attribute ID	Access	Name	Data type	Value	Details
1	Get	Revision	UINT	X	Revision index of the class
2	Get	Max Instances	UINT	1	1 defined instance
3	Get	Number of Instances	UINT	1	-
4	Get	Optional attribute list	UINT	1	-
5	Get	Optional service list	UINT	1	-
6	Get	Max ID of class attributes	UINT	7	-
7	Get	Max ID of instance attribute	UINT	6	-

Supported Instance Attributes

Attribute ID	Access	Name	Data type	Details
1	Get	Status	DWORD	0 = The Interface Configuration attribute has not been configured 1 = The Interface Configuration attribute contains valid configuration
2	Get	Configuration capability	DWORD	Bit 0 = 1 (TRUE) shall indicate the device is capable of obtaining its network configuration via BOOTP Bit 1 = 1 (TRUE) shall indicate the device is capable of resolving host names by querying a DNS server Bit 2 = 1 (TRUE) shall indicate the device is capable of obtaining its network configuration via DHCP Bit 3 = 1 (TRUE) shall indicate the device is capable of sending its host name in the DHCP request Bit 4 = 1 (TRUE) shall indicate the Interface Configuration attribute is settable. Bit 5-31: reserved
3	Get/Set	Configuration control	DWORD	Bits 0-3 Start-up configuration 0 = The device shall use the interface configuration values previously stored 1 = The device shall obtain its interface configuration values via BOOTP 2 = The device shall obtain its interface configuration values via DHCP upon start-up ⁽¹⁾ 3-15 = Reserved for future use Bit 4 = 1 (TRUE), the device shall resolve host names by querying a DNS server Bit 5-31: reserved
4	Get	Physical Link Object	STRUCT of UINT EPATH	Path Size Path: Logical segments identifying the physical link object Example [20][F6][24][01]: [20] = 8 bit class segment type; [F6] = Ethernet Link Object class; [24] = 8 bit instance segment type; [01] = instance 1
5	Get/Set	Interface Configuration	STRUCT of UDINT UDINT UDINT UDINT UDINT String	IP address (0: no address configured) Network Mask (0: no Network mask configured) Gateway address (0: no address configured) Name server address (0: no address configured) Name server address 2 (0: no address configured) Domain Name
6	Get/Set	Host Name	String	Read/write name of the drive
8	Get/Set	TTL value	USINT	TTL value for Ethernet/IP multicast packets
9	Get/Set	Mcast Config	Struct Of.	IP Multicast address configuration
		Alloc Control	USINT	0 - Use default allocation algorithm to generate multicast addresses 1 - Multicast addresses shall be allocated according to the values in Num Mcast and Mcast Start Addr
		Reserved	USINT	Shall be 0
		Num Mcast	UINT	Number of multicast addresses to allocate for EtherNet/IP
		Mcast Start Addr	UDINT	Starting multicast address from which to begin allocation

(1) If set option board parameter OBP:FDRU=0 will also be set to implicitly disable the FDR mechanism on the DHCP protocol. This to be compatible with CIP tools that has configured the device to operate in a non-FDR specific environment. The user has to manually enable the feature if desired to be used.

Supported Class Services

Service Code	Service Name	Description
01 hex	Get_Attribute_All	Read all attributes
0E hex	Get_Attribute_Single	Read one attribute
10 hex	Set_Attribute_Single	Write one attribute

Supported Instance Services

Service Code	Service Name	Description
0E hex	Get_Attribute_Single	Read one attribute
10 hex	Set_Attribute_Single	Write one attribute
01 hex	Get_Attribute_All	

TCP/IP Interface Behavior

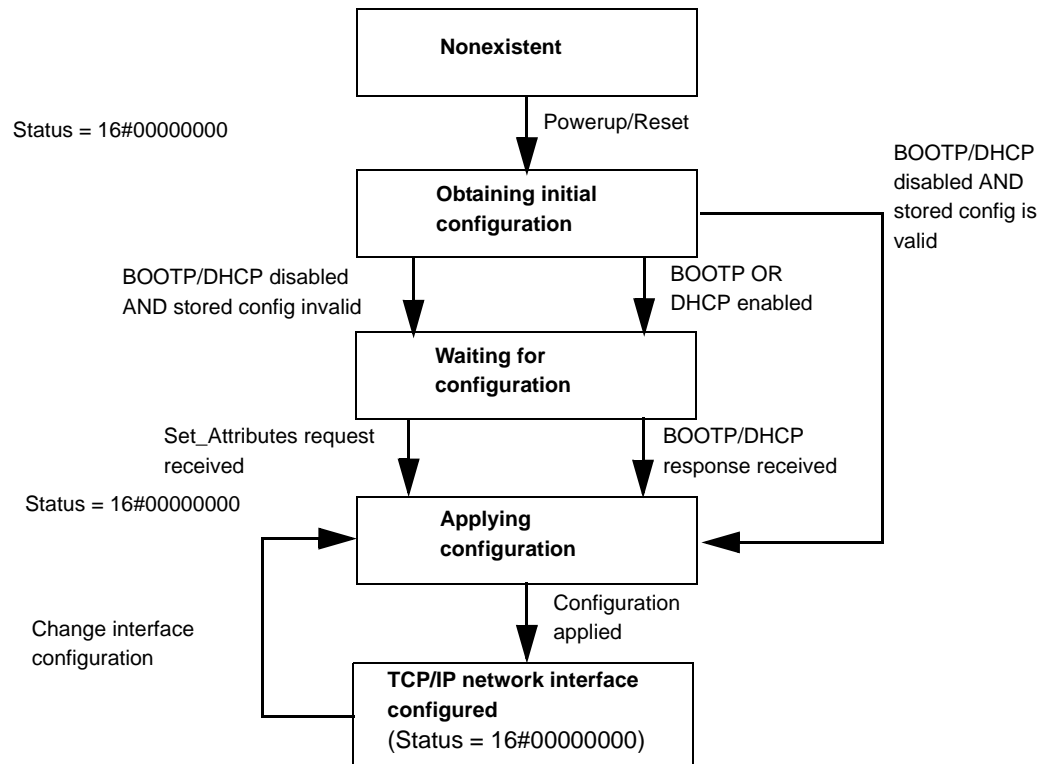

Ethernet Link Object (F6h)

Supported Class Attributes

Attribute ID	Access	Name	Data type	Value	Details
1	Get	Revision	UINT	X	Revision index of the class
2	Get	Max Instances	UINT	1	1 defined instance
3	Get	Number of Instances	UINT	1	-
6	Get	Max ID of class attributes	UINT	7	-
7	Get	Max ID of instance attribute	UINT	6	-

Supported Instance Attributes

Attribute ID	Access	Name	Data type	Details
1	Get	Interface Speed	UDINT	Interface speed currently in use
2	Get	Interface Flags	DWORD	<p>Bit 0: Link Status Indicates whether or not the Ethernet 802.3 communications interface is connected to an active network. 0 indicates an inactive link; 1 indicates an active link</p> <p>Bit 1: Half/Full Duplex Indicates the duplex mode currently in use. 0 indicates the interface is running half duplex; 1 indicates full duplex</p> <p>Bit 2-4: Negotiation Status</p> <ul style="list-style-type: none"> - 0 = Auto-negotiation in progress - 1 = Auto-negotiation and speed detection failed - 2 = Auto negotiation failed but detected speed Duplex was defaulted - 3 = Successfully negotiated speed and duplex - 4 = Auto-negotiation not attempted. Forced speed and duplex <p>Bit 5: Manual Setting Requires Reset. 0 indicates the interface can activate changes to link parameters (auto-negotiate, duplex mode, interface speed) automatically. 1 indicates the device requires a Reset service be issued to its Identity Object in order for the changes to take effect.</p> <p>Bit 6: Local Hardware Fault. 0 indicates the interface detects no local hardware fault; 1 indicates a local hardware fault is detected. The meaning of this is product-specific</p> <p>Bit 7-31: Reserved Shall be set to zero</p>
3	Get	Physical Address	USINT [6]	MAC layer address
4	Get	Interface counters	-	-
5	Get	Media counters	-	-
6	Get/Set	Interface Control	-	Force auto negotiate, half full and speed
7	Get	Interface Type	USINT	2
10	Get	Interface Label	SHORT_STRING	ATV320: Instance 1: "Left" ATV320: Instance 2: "Right"

Supported Class Services

Service code	Service Name	Description
0E hex	Get_Attribute_Single	Read one attribute
01 hex	Get_Attribute_All	-

Supported Instance Services

Service Code	Service Name	Description
0E hex	Get_Attribute_Single	Read one attribute
10 hex	Set_Attribute_Single	Write one attribute
01 hex	Get_Attribute_All	-
4C hex	Get_And_Clear	Same than Get_Attribute_Single

Assembly Object (04 hex)**Supported Class Attributes**

Attribute ID	Access	Name	Data type	Value	Details
1	Get	Revision	UINT	X	Revision index of the class
2	Get	Max Instances	UINT	1	1 defined instance
3	Get	Number of Instances	UINT	1	
6	Get	Max ID of class attributes	UINT	7	
7	Get	Max ID of instance attribute	UINT	3	

Supported Instances

Attribute ID	Access	Name	Data type	Value	Details
3	Get/Set	Data	ARRAY OF BYTE		
4	Get	Size	UINT		

Supported Instances for Altivar 320

Instance	Type	Name
20	AC Drive Output	CIP Basic Speed Control Output
21	AC Drive Output	CIP Extended Speed Control Output
70	AC Drive Input	CIP Basic Speed Control Input
71	AC Drive Input	CIP Extended Speed Control Input
100	AC Drive Output	Native Drive Output
101	AC Drive Input	Native Drive Input

Supported Class Services

Service code	Service Name	Description
0E hex	Get_Attribute_Single	Read one attribute

Supported Instance Services

Service Code	Service Name	Description
0E hex	Get_Attribute_Single	Read one attribute
10 hex	Set_Attribute_Single	Write one attribute

Output instance data description

Instance	Byte	Bit7	Bit6	Bit5	Bit4	Bit3	Bit2	Bit1	Bit0
20	0	X	X	X	X	X	Fault Reset 0 = No command 1= Fault Reset	X	Run Forward 0 = Stop 1 = Run
	1	X	X	X	X	X	X	X	X
	2-3	Speed Actual (rpm)							
21	0	X	Net Reference 0 = Local, by terminal 1= Network	Net Command 0 = Local 1 = Network	X	X	Fault Reset 0=No command 1= Fault Reset	Run Fwd / Reverse: 00: Quick stop 01: Run forward 10: Run reverse 11: No action	
	1	X	X	X	X	X	X	X	X
	2-3	Speed Actual (rpm)							
100	0-1	I/O Scanning word 1							
	2-3	I/O Scanning word 2							
	4-5	I/O Scanning word 3							
	6-7	I/O Scanning word 4							
	8-9	I/O Scanning word 5							
	10-11	I/O Scanning word 6							
70	0	X	X	X	X	X	0 = Stopped 1 = Running	X	0 = No fault 1 = Fault
	1	X	X	X	X	X	X	X	X
	2-3	Speed Actual (rpm)							
71	0	At Reference 0 = Not reached 1 = Reached	Ref From Net 0 = From terminal 1 = From network	Cmd From Net 0 = From terminal 1 = From network	Ready 0 = Not ready 1 =Ready	Running Fwd / reverse 00: Stopped 01: Running Forward 10: Running reverse 11: Not used		Warning 0 = No warning 1 = Warning	Not used
	1	X	X	X	X	X	000: Not used 001: Startup 010: Not ready 011: Ready 100: Enabled 101: Stopping 110: Fault stop 111: Faulted		
	2-3	Speed Actual (rpm)							
101	0-1	Scanner Read word 1							
	2-3	Scanner Read word 2							
	4-5	Scanner Read word 3							
	6-7	Scanner Read word 4							
	8-9	Scanner Read word 5							
	10-11	Scanner Read word 6							

Connection Manager Object (06h)

Class Code

Hexadecimal	Decimal
16#05	5

Class Attributes

Attribute ID	Access	Name	Need	Data type	Value	Details
1	Get	Revision	Opt.	UINT	X	Revision index of the class
2	Get	Max instances	Opt.	UINT	4	3 defined instances

Attributes of Instance 1 - Explicit Message Instance

Attribute ID	Access	Name	Need	Data type	Value	Details
1	Get	State	Req.	USINT	-	0: Non-existent 3: Established 5: Deferred Delete
2	Get	Instance_type	Req.	USINT	0	Explicit Message
3	Get	TransportClass_trigger	Req.	BYTE	16#83	Class 3 server
4	Get	Produced_connection_id	Req.	UINT	10xxxxxx011	xxxxxx = Node address
5	Get	Consumed_connection_id	Req.	UINT	10xxxxxx100	xxxxxx = Node address
6	Get	Initial_comm_characteristics	Req.	BYTE	16#21	Explicit messaging via Group 2
7	Get	Produced_connection_size	Req.	UINT	36	Produced data maximum size (in bytes)
8	Get	Consumed_connection_size	Req.	UINT	36	Consumed data maximum size (in bytes)
9	Get/Set	Expected_packet_rate	Req.	UINT	2500	2.5 sec. (TimeOut)
12	Get/Set	Watchdog_timeout_action	Req.	USINT	1 or 3	1: Auto-Delete 3: Deferred Delete (Default)
13	Get	Produced connection path length	Req.	UINT	0	Length of attribute 14 data
14	Get	Produced connection path	Req.	Array of UINT	Null	Empty
15	Get	Consumed connection path length	Req.	UINT	0	Length of attribute 16 data
16	Get	Consumed connection path	Req.	Array of UINT	Null	Empty

Refer to Ethernet/ specification for more information.

Supported Class Attributes

Attribute ID	Access	Name	Data type	Value	Details
1	Get	Revision	UINT	X	Revision index of the class
2	Get	Max Instances	UINT	1	1 defined instance
3	Get	Number of Instances	UINT	1	-
4	Get	Optional attribute list	STRUCT of		List of optional attribute numbers
6	Get	Max ID of class attributes	UINT	7	-
7	Get	Max ID of instance attributes	UINT		Attribute ID number of last class attribute

Supported Instance1 (Explicit) Attributes

Attribute ID	Access	Name	Data type	Details
1	Get	Open Requests	UINT	Number of Forward Open service requests received.
2	Get	Open Format Rejects	UINT	Number of Forward Open service requests which were rejected due to bad format.
3	Get	Open Resources Rejects	UINT	Number of Forward Open service requests which were rejected due to lack of resources.
4	Get	Open Other Rejects	UINT	Number of Forward Open service requests which were rejected for reasons other than bad format or lack of resources.
5	Get	Close Requests	UINT	Number of Forward Close service requests received.
6	Get	Close Format Requests	UINT	Number of Forward Close service requests which were rejected due to bad format.
7	Get	Close Other Requests	UINT	Number of Forward Close service requests which were rejected for reasons other than bad format.
8	Get	Connection Timeouts	UINT	Total number of connection timeouts that have occurred in connections controlled by this Connection Manager

Supported Class Services

Service code	Service Name	Description
01 hex	Get_Attribute_All	Read all attributes
0E hex	Get_Attribute_Single	Read one attribute

Supported Instance Services

Service Code	Service Name	Description
0E hex	Get_Attribute_Single	Read one attribute
10 hex	Set_Attribute_Single	Write one attribute
4Ehex	Forward_Close	Closes a connection
54hex	Forward_Open	Opens a connection, maximum data size is 511 bytes

Motor Data Object (28h)

Supported Class Attributes

Attribute ID	Access	Name	Data type	Value	Details
1	Get	Revision	UINT	X	Revision index of the class
2	Get	Max Instances	UINT	1	1 defined instance
3	Get	Number of Instances	UINT	1	-
6	Get	Max ID of class attributes	UINT	7	-
7	Get	Max ID of instance attribute	UINT	15	-

Supported Instance Attributes

Attribute ID	Access	Name	Need	Data type	ATV320	Details
1	Get	NumAttr	Opt.	USINT	No	-
2	Get	Attributes List	Opt.	USINT (ARRAY)	No	-
3	Get	MotorType	Req.	USINT	Yes	-
6	Get/Set	RatedCurrent	Req.	UINT	Yes	Motor nominal current Linked to NCR drive parameter. NCR unit is 0,1 A as attribute 6.
7	Get/Set	RatedVoltage	Req.	UINT	Yes	Motor nominal voltage Linked to UNS drive parameter UNS unit is 1V as attribute 7
8	Get/Set	RatedPower	Opt.	UINT	No	-
9	Get/Set	RatedFreq	Opt.	UINT	Yes	Motor nominal frequency Linked to FRS drive parameter FRS unit is 0,1 Hz. The parameter value has to be divided by 10 to be in the unit of attribute 9
12	Get/Set	PoleCount	Opt.	UINT	No	-
15	Get/Set	BaseSpeed	Opt.	UINT	Yes	Motor nominal speed Linked to NSP drive parameter NSP unit is 1rpm as attribute 15

Supported Class Services

Service Code	Service Name	Description
0E hex	Get_Attribute_Single	Read one attribute

Supported Instance Services

Service Code	Service Name	Description
0E hex	Get_Attribute_Single	Read one attribute
10 hex	Set_Attribute_Single	Write one attribute

Control Supervisor Object (29h)

Supported Class Attributes

Attribute ID	Access	Name	Data type	Value	Details
1	Get	Revision	UINT	X	Revision index of the class
2	Get	Max Instances	UINT	1	1 defined instance
3	Get	Number of Instances	UINT	1	-
6	Get	Max ID of class attributes	UINT	7	-
7	Get	Max ID of instance attribute	UINT	17	-

Supported Instance Attributes for Schneider Electric

Attribute ID	Access	Name	Data type	Details
3	Get/Set	Run Fwd	BOOL	On edge (0 --> 1)
4	Get/Set	Run Rev	BOOL	On edge (0 --> 1)
5	Get/Set	Net Ctrl	BOOL	0: Local Control 1: Network Control (default)
6	Get	State	USINT	See state machine: 0: 1: Startup 2: Not_Ready 3: Ready 4: Enabled 5: Stopping 6: Fault_stop 7: Faulted
7	Get	Running Fwd	BOOL	ETA.15 = 0
8	Get	Running Rev	BOOL	ETA.15=1
9	Get	Ready	BOOL	ETA.1=1
10	Get	Faulted	BOOL	ETA.7=1
12	Get/Set	Fault Rst	BOOL	CMD.7 = 1.
13	Get	Fault Code	UINT	Parameter <i>ErrCd</i>
15	Get	Ctrl From Net	BOOL	0: Local Control 1: Network Control
16	Get/Set	DN Fault Mode	USINT	Action on loss of CIP network. 0: Stop + <i>CnF</i> detected fault 1: Ignored
17	Get/Set	ForceFault/Trip	BOOL	Force <i>CnF</i> detected fault (On edge)

Supported Class Services

Service Code	Service Name	Description
0E hex	Get_Attribute_Single	Read one attribute

Supported Instance Services

Service Code	Service Name	Description
0E hex	Get_Attribute_Single	Read one attribute
10 hex	Set_Attribute_Single	Write one attribute
05 hex	Reset	Reset drive

Control Supervisor States

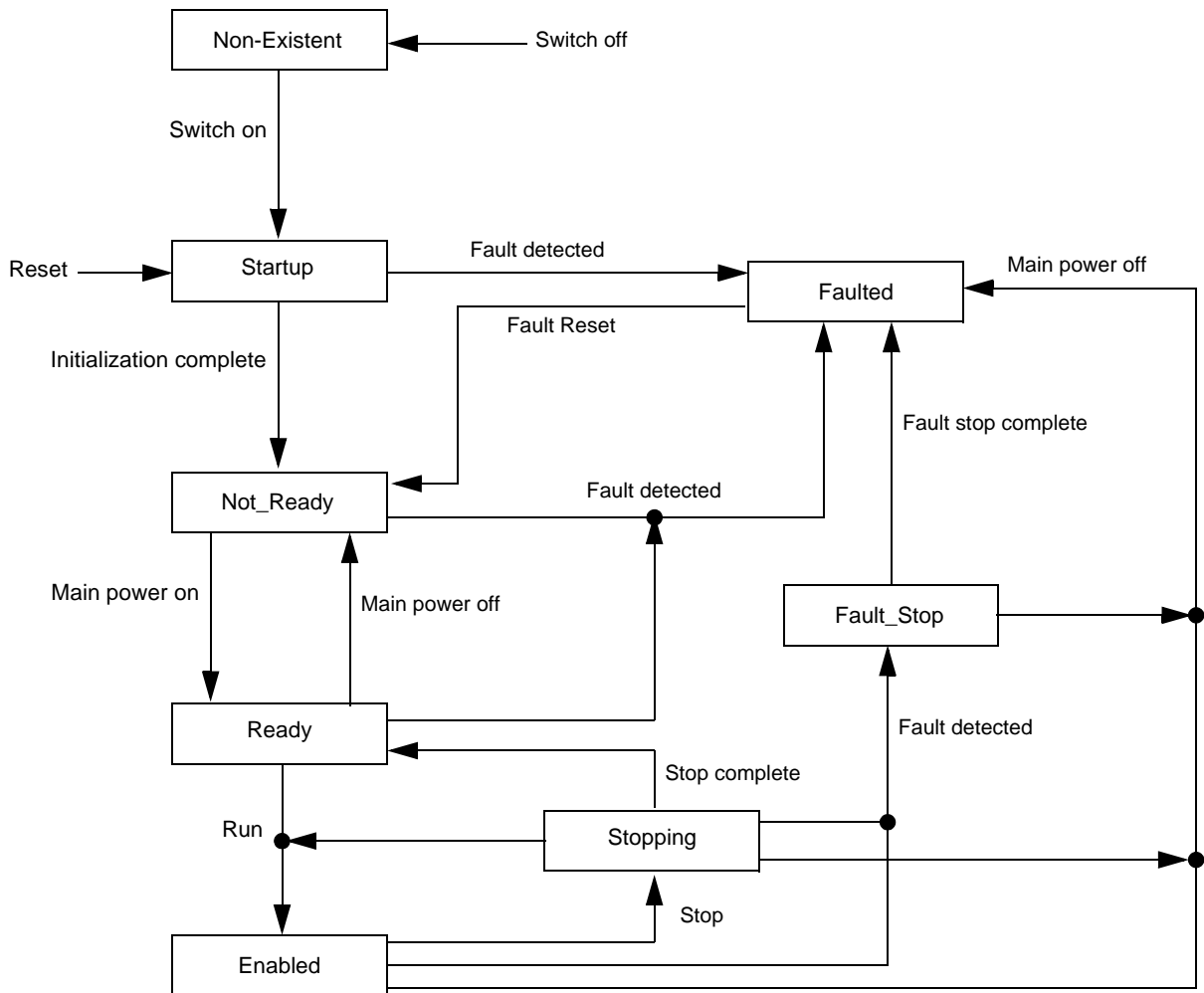

AC/DC Drive Object (2Ah)

Supported Class Attributes

Attribute ID	Access	Name	Data type	Value	Details
1	Get	Revision	UINT	X	Revision index of the class
2	Get	Max Instances	UINT	1	1 defined instance
3	Get	Number of Instances	UINT	1	-
6	Get	Max ID of class attributes	UINT	7	-
7	Get	Max ID of instance attribute	UINT	21	-

Supported Instance

Attribute ID	Access	Name	Need	Data type	ATV320	Comments
1	Get	NumAttr	Opt.	USINT	No	-
2	Get	Attributes List	Opt.	USINT (ARRAY)	No	-
3	Get	At Reference	Opt.	BOOL	Yes	Use the result of the "reference reached" function of the device. No more, no less specific adjustment than what is in the drive function.
4	Get/Set	NetRef	Req.	BOOL	Yes	Image of the NetRef signal received from the network. 'Get' order returns the value written by 'Set' order. Used to manage the reference channel.
6	Get	Drive mode	Req.	USINT	Yes	Used to get the drive mode. In the standard, the attribute can also be used to set the drive mode, but it is not possible on our products. Value is fixed at 1. NOTE: On other drives this value main depends on the Motor control law set in the device.
7	Get	Speed Actual	Req.	INT	Yes	Used to get the value of the motor Speed. Unit: rpm
8	Get/Set	SpeedRef	Req.	INT	Yes	Image of the Speed Reference signal received from the network. Unit: rpm 'Get' order returns the value written by 'Set' order Used to set the speed reference in the drive.
9	Get	Current Actual	Opt.	INT	Yes	Used to get the value of the current in the motor. Unit: 0.1 Amps
10	Get/Set	Current Limit	Opt.	INT	Yes	Unit: 0,1 Amps. Used to set or get the current value used for the motor thermal protection.
11	Get	Torque Actual	Opt.	INT	Yes	Used to get the value of the motor torque Unit: 1 N.m
15	Get	Power Actual	Opt.	INT	No	Used to get the value of the output power. Unit 1 <--> 1/2PowerScale.
18	Get/Set	AccelTime	Opt.	UINT	Yes	Used to get and set the acceleration time ⁽¹⁾ Units ms ⁽²⁾
19	Get/Set	DecelTime	Opt.	UINT	Yes	Used to get and set the deceleration time ⁽¹⁾ Units: ms ⁽²⁾
20	Get/Set	LowSpdLimit	Opt.	UINT	Yes	Used to get and set the low speed limit. Units: rpm
21	Get/Set	HighSpdLimit	Opt.	UINT	Yes	Used to get and set the high speed limit. Units: rpm
26	Get/Set	PowerScale	Opt.	SINT	No	
28	Get/Set	TimeScale	Opt.	SINT	No	Default value = 0
29	Get	RefFromNet	Opt.	BOOL	No	Used to know if the drive is processing the reference sent by the NetWork that asks the Attribute 29 value
46	Get	Cumulative Run Time	Brand	UINT	No	Cumulative run time

(1) For the standard, the acceleration and deceleration time are given to go from 0 to HighSpdLimit (attribute 21 of AC/DC drive object). For Altivar 320, the acceleration and deceleration time are given to go from 0 to the motor nominal frequency ((*Fr5*) parameter).

(2) Altivar 320: In the drive, the unit of acceleration and deceleration time depends on INR parameter.

(*inr*) = 0: acceleration and deceleration time are in 0,01s

(*inr*) = 1 (factory setting): acceleration and deceleration time are in 0,1s

(*inr*) = 2: acceleration and deceleration time are in 1s

The minimal requirement is to have this attribute in ms when (*inr*) parameter is in factory setting.

Attribute ID	Details
3	Attribute value = value of bit 10 of ETA drive parameter (TBC)
7	Motor speed. Linked to (<i>r F r d</i>) drive parameter (TBC). (<i>r F r d</i>) is in 1rpm on ATV320 as attribute 7
8	Speed reference. Linked to (<i>L F r d</i>) drive parameter (TBC). (<i>L F r d</i>) is in 1rpm on ATV320 as attribute 8
9	Actual current in the motor. Linked to (<i>L C r</i>) drive parameter. (<i>L C r</i>) is in 0,1A on ATV320 as attribute 9
10	Current value used for the motor thermal protection. Linked to (<i>i t H</i>) drive parameter. (<i>i t H</i>) is in 0,1A on ATV320 as attribute 10
11	Actual torque in the motor. Linked to (<i>o t r n</i>) drive parameter (TBC). (<i>o t r n</i>) is in 0,1 N.m on ATV320. The value has to be multiplied by 10 to be in the unit of attribute 11
18	Acceleration time. Linked to (<i>A C C</i>) drive parameter. See note (2) of the specification above
19	Deceleration time. Linked to (<i>d E C</i>) drive parameter. See note (2) of the specification above
20	Low speed. Linked to (<i>S n , L</i>) drive parameter. (<i>S n , L</i>) is in 1rpm on ATV320 as attribute 20
21	High speed. Linked to (<i>S n A L</i>) drive parameter. (<i>S n A L</i>) is in 1rpm on ATV320 as attribute 21

Supported Class Services

Service Code	Service Name	Description
0E hex	Get_Attribute_Single	Read one attribute

Supported Instance Services

Service Code	Service Name	Description
0E hex	Get_Attribute_Single	Read one attribute
10 hex	Set_Attribute_Single	Write one attribute

Application Object (70h to C7h) / Explicit Messaging

Application Object Behavior

$$\text{Class} = ((\text{AdL} - 3000) / 200) + 70\text{h}$$

$$\text{Instance} = 1$$

$$\text{Attribute} = (\text{AdL} \% 200) + 1$$

$$\text{AdL} = (\text{Class} - 70\text{h}) * 200 + \text{Attribute} - 1 + 3000$$

This rule allows the access to address under 20599. The other address are not accessible.

The drive parameters are grouped into classes.

- Each application class has only 1 instance.
- Each instance groups 200 parameters.
- Each attribute in an instance relates to a parameter.

Example:

Drive logical address	Hexadecimal path
3 000	16# 70 / 01 / 01
3 100	16# 70 / 01 / 65
3 200	16# 71 / 01 / 01

Supported Class Attributes

Attribute ID	Access	Name	Data type	Value	Details
1	Get	Revision	UINT	X	Revision index of the class
2	Get	Max Instances	UINT	1	1 defined instance
3	Get	Number of Instances	UINT	1	-
6	Get	Max ID of class attributes	UINT	7	-
7	Get	Max ID of instance attribute	UINT	X	-

Supported Instance Attributes

Attribute ID	Access	Name	Data type	Details
1	Get/Set	1st parameter of the block	UINT	Value returned by the drive at Address xx
..	Value returned by the drive at Address xx
X	Get/Set	Last parameter of the block	UINT	Value returned by the drive at Address xx

Supported Class Services

Service Code	Service Name	Description
0E hex	Get_Attribute_Single	Read one attribute

Supported Instance Services

Service Code	Service Name	Description
0E hex	Get_Attribute_Single	Read one attribute
10 hex	Set_Attribute_Single	Write one attribute

