

Panasonic

Integrated Display Type For Gas

NEW DIGITAL FLOW SENSOR

FM-200 SERIES

CE
Conforming to
EMC Directive

Ro
RoHS Compatible

Dual color with sub display at a glance

Easy-to-read 2-color display with sub display



0.5 ℓ /min.

100 ℓ /min.

1,000 ℓ /min.

Easy-to-see dual color with sub display!

The setting conditions are displayed on the sub display, making it much easier to keep track of operations. In addition, the digital display which switches between 2 colors lets you check the status of sensor operation at a glance.

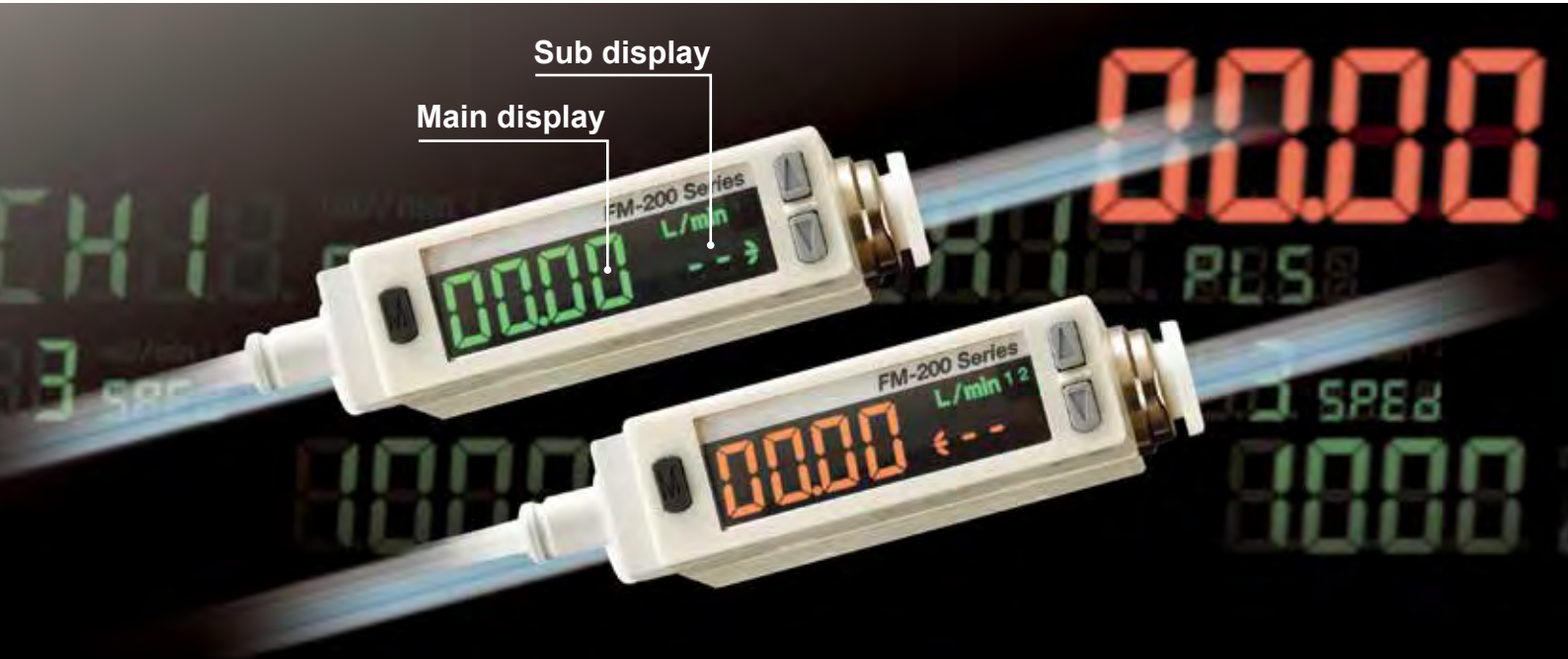

Easy to see with the sub display!

Setting values and setting items can be checked at the same time.



Dual color display at a glance

The display color changes in accordance with output ON / OFF operations.

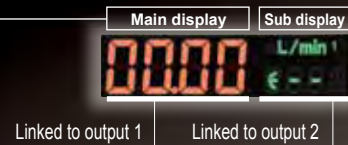

High precision of $\pm 3\%$ F.S.

A new rectification mechanism and Micro Electro Mechanical System (MEMS) technology allow the sensor to be mounted on a Si sensor chip (3×3.5 mm 0.118×0.138 in). This provides an extremely small heat capacity, high precision of $\pm 3\%$ F.S. and high-speed response. The two temperature sensors on each side of the heater detect the heat distribution to make bidirectional detection possible.

Principle of Si sensor chip

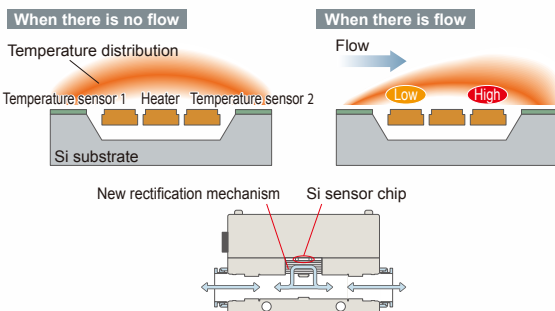

One sensor for both intake and exhaust

A single sensor can detect flows bidirectionally. In addition, it can be set to detect flows in either the forward or reverse direction only, making it suitable for a variety of applications.

One sensor detects both directions



For example, using a single sensor to check chip suction

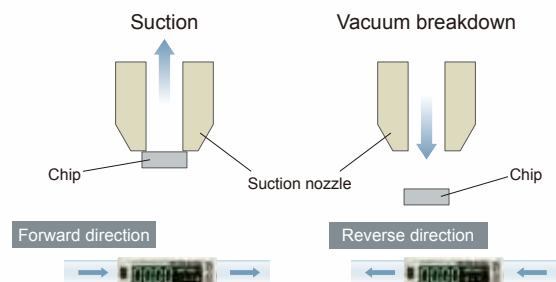

FM-200 SERIES LINE-UP

Low flow rate type

FM-252-4(-P) / FM-213-4(-P)
 FM-253-4(-P) / FM-214-4(-P)

- Port size: $\varnothing 4$ mm $\varnothing 0.157$ in push-in
- Size: W17 × H37 × D64 mm W0.669 × H1.457 × D2.520 in
- Body material: Resin



Flow rate range

0.5 *e*/min.
 1 *e*/min.
 5 *e*/min.
 10 *e*/min.

Smallest Type

Medium flow rate type

FM-254-8(-P)
 FM-215-8(-P)

- Port size: $\varnothing 8$ mm $\varnothing 0.315$ in push-in
- Size: W17 × H43 × D70.6 mm W0.669 × H1.693 × D2.780 in
- Body material: Resin



Flow rate range

50 *e*/min.
 100 *e*/min.

High flow rate type Industry's smallest in size (Based on research conducted by SUNX as of March 2008)

FM-255-AR2(-P) / FM-255-AG2-P
 FM-216-AR2(-P) / FM-216-AG2-P

- Port size: Rc $\frac{1}{2}$ female thread, G $\frac{1}{2}$ female thread
- Size: W30 × H50 × D80 mm W1.181 × H1.969 × D3.150 in
- Body material: Aluminum



Flow rate range

500 *e*/min.
 1,000 *e*/min.

Largest type

Images represent original sizes

Suitable for cost and quality control! Integrated output mode incorporated

The FM-200 series can control and manage flows in a wide variety of output modes such as integrated output mode, depending on the required application.

Integrated flow rate display



Integrated flow rate can be displayed with 7 digits

Integrated output mode

Quality control

When the volume of flow of the gas being measured reaches the set integrated value, output switches to ON or OFF.

- Controls N₂ charging volumes for electronic components
- Controls air blowing volumes, etc.

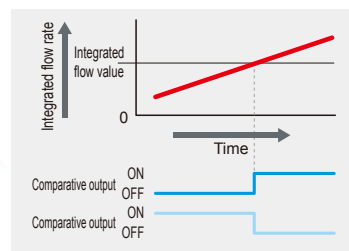

Integrated pulse output mode

Cost management

The pulse output is generated once at every specified integrated value*. This lets you know the amount of air consumed per unit of time easily.

- Controls N₂ purge volumes in reflow furnaces
- Controls overall volumes of air consumed by equipment, etc.



* Integrated values are specified by range and can vary. For details, refer to "SPECIFICATIONS" (p.6).

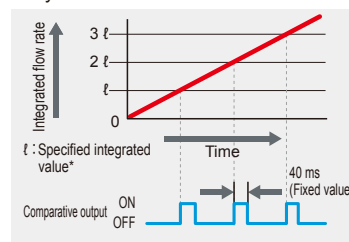

Energy-saving and environmental-friendly

The pulse output from the flow sensor can be inputted to the pulse counter of an Eco-Power Meter so that air consumption and power consumption can both be measured simultaneously.

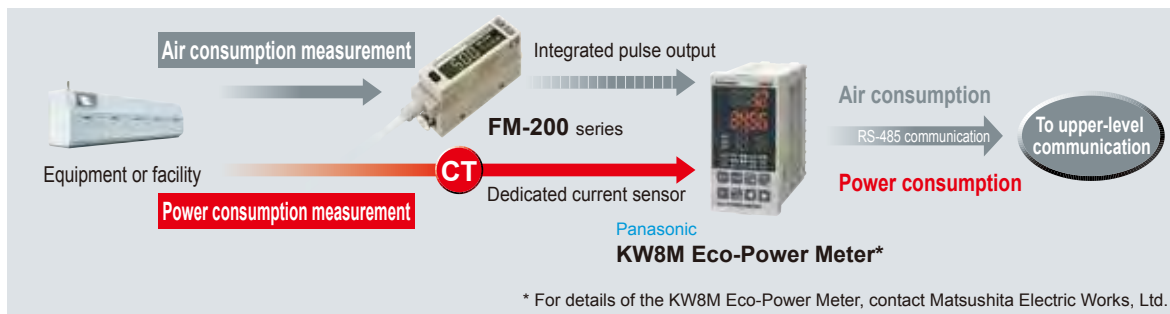

Instant flow rate display (Factory setting)



Window comparator mode

This mode is used for setting comparative output to ON or OFF at flow rates within the setting range.

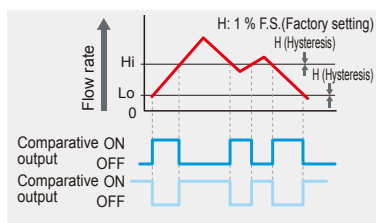

Hysteresis mode

This mode is used for setting comparative output hysteresis to the desired level and for carrying out ON / OFF control.

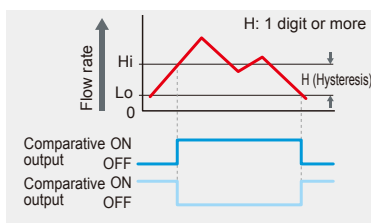

Output OFF mode

Comparative output is forcibly maintained at OFF regardless of the setting value.

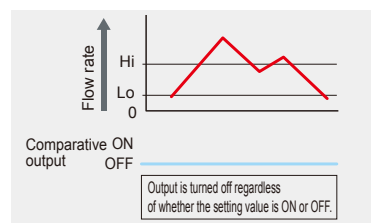

■ Applications

Controlling purge gas and air blowing

By controlling purge gas and air blowing, performance and quality of the products can be maintained, while contributing to cost reduction.



Checking seating

Flow sensors can be used for stable detection of transparent objects which were difficult to detect using photoelectric sensors. The nozzle can be extended for detection even in places where oil spatter occurs.



Checking suction

Detection of objects is possible even on conveyors with low suction pressures where air is flowing constantly (such as collet conveyors and network conveyors).

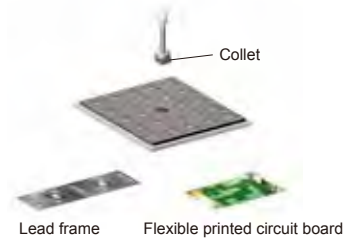

No straight pipes needed



The rectification method used by the new mechanism makes straight pipes unnecessary at both the intake and exhaust sides.

Flexible installation direction



Other than the ability to carry out bidirectional detection, there are no limitations on the installation direction, making the installation very flexible.

Connection



Quick connection is possible with a cover-attached connector.

Panel mounting bracket (Available soon)





Tight installation of multiple sensors on the panel in vertical direction is possible.

Equipped with a wide variety of functions for greater ease of use

- Integrated value reset function** During integrated mode, external input allows reset of the integrated value.
- Analog voltage output** 1 to 5 V analog voltage output is incorporated.
- Key lock function** Key operation can be disabled to prevent mis-operation.
- Rattle prevention function (Response time setting)** The response time can be set to one of seven steps from 50 ms to approximately 1,500 ms. This prevents rattling from rapid changes in flow or from noise.
- Display rate setting** The display update period for the digital display can be changed to 250 ms, 500 ms or 1,000 ms in order to eliminate display flickering.
- ECO mode** After approx. one minute of no operation, sensor will be switched to ECO mode. Backlight will be turned off to reduce power consumption.

ORDER GUIDE

Type	Appearance	Applicable fluid	Flow rate range	Model No.	Port size	Comparative output		
Resin body type		Clean air (Note) Compressed air (Note) Nitrogen gas	500 ml/min.	FM-252-4	ø4 ø0.157 push-in	NPN Open-collector transistor		
				FM-252-4-P		PNP Open-collector transistor		
			1,000 ml/min.	FM-213-4		NPN Open-collector transistor		
				FM-213-4-P		PNP Open-collector transistor		
			5 l/min.	FM-253-4		NPN Open-collector transistor		
				FM-253-4-P		PNP Open-collector transistor		
	10 l/min.		FM-214-4	NPN Open-collector transistor				
			FM-214-4-P	PNP Open-collector transistor				
			50 l/min.	FM-254-8		ø8 ø0.315 push-in	NPN Open-collector transistor	
				FM-254-8-P			PNP Open-collector transistor	
100 l/min.		FM-215-8	NPN Open-collector transistor					
		FM-215-8-P	PNP Open-collector transistor					
Aluminum body type				500 l/min.	FM-255-AR2		Rc ¹ / ₂ female thread	NPN Open-collector transistor
					FM-255-AR2-P			PNP Open-collector transistor
	1,000 l/min.			FM-255-AG2-P	G ¹ / ₂ female thread	PNP Open-collector transistor		
				FM-216-AR2	Rc ¹ / ₂ female thread	NPN Open-collector transistor		
				FM-216-AR2-P		PNP Open-collector transistor		
				FM-216-AG2-P	G ¹ / ₂ female thread	PNP Open-collector transistor		

Note: The clean air complies with JIS B 8392-1.1.1 to 5.6.2, and the compressed air complies with JIS B 8392-1.1.1 to 1.6.2.

Accessory

- CN-F15-C1 (Connector attached cable 1 m 3.281 ft)



OPTIONS

Designation	Model No.	Description
Sensor mounting bracket	MS-FM2-1	Allows resin body type sensor to be installed on the flooring.
	MS-FM2-2	Allows aluminum body type sensor to be installed on the flooring.
Panel mounting bracket	MS-FM2-3	Allows resin body type sensor to be installed to panels. Multiple sensors can also be mounted closely.

Sensor mounting bracket

- MS-FM2-1

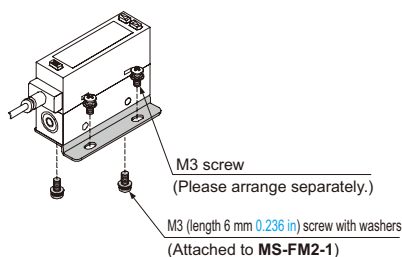

- MS-FM2-2

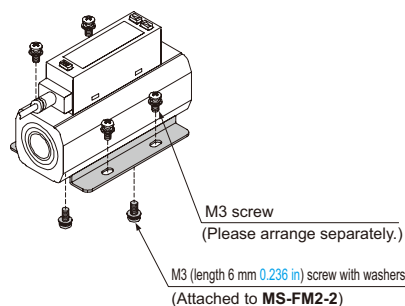

Recommended vacuum filter

Manufactured by Nihon Pisco Co., Ltd.
 VFU1-44-15P (Element length 15 mm 0.591 in)
 VFU1-44-25P (Element length 25 mm 0.984 in)
 VFE015B01 (Filter element for refill,)
 length 15 mm 0.591 in
 VFE025B01 (Filter element for refill,)
 length 25 mm 0.984 in



Note: Contact the manufacturer for details of the recommended products.

SPECIFICATIONS

Individual specifications

Type		Resin body type					
Item	Model No.	FM-252-4(-P)	FM-213-4(-P)	FM-253-4(-P)	FM-214-4(-P)	FM-254-8(-P)	FM-215-8(-P)
Full scale flow rate (Note 1)		500 mL/min.	1,000 mL/min.	5 L/min.	10 L/min.	50 L/min.	100 L/min.
Instant flow rate	Display range (Note 2)	-550 to +550 mL/min.		-1,100 to +1,100 mL/min.		-5.5 to +5.5 L/min.	
	Setting and display resolution	1 mL/min.		0.01 L/min.		0.1 L/min.	
Integrated flow rate	Display range (Note 2)	±9999999 mL		±99999.99 L		±999999.9 L	
	Setting and display resolution	1 mL		0.01 L		0.1 L	
Specified integrated value		5 mL	10 mL	0.05 L	0.1 L	0.5 L	1 L
Port size		ø4 ø0.157 push-in				ø8 ø0.315 push-in	
Weight		Net weight: 50 g approx., Gross weight: 115 g approx.				Net weight: 70 g approx., Gross weight: 135 g approx.	

Type		Aluminum body type			
Item	Model No.	FM-255-AR2(-P)	FM-255-AG2-P	FM-216-AR2(-P)	FM-216-AG2-P
Full scale flow rate (Note 1)		500 L/min.		1,000 L/min.	
Instant flow rate	Display range (Note 2)	-550 to +550 L/min.		-1,100 to +1,100 L/min.	
	Setting and display resolution	1 L/min.			
Integrated flow rate	Display range (Note 2)	±9999999 L			
	Setting and display resolution	1 L			
Specified integrated value		5 L		10 L	
Port size		Rc1/2 female thread	G1/2 female thread	Rc1/2 female thread	G1/2 female thread
Weight		Net weight: 155 g approx., Gross weight: 220 g approx.			

Common specifications

Type		NPN output type	PNP output type
Item	Model No.	FM-2□	FM-2□-P
Rated pressure range		-0.09 to +0.7 MPa	
Pressure withstandability		1 MPa	
Applicable fluid		Clean air (Note 3), compressed air (Note 3), nitrogen gas	
Supply voltage		12 to 24 V DC ± 10 % Ripple P-P10 % or less	
Current consumption		Normal mode: 60 mA or less, ECO mode: 40 mA or less	
Comparative outputs (Comparative output 1 / Comparative output 2)		NPN open-collector transistor <ul style="list-style-type: none"> Maximum sink current: 50 mA or less Applied voltage: 26.4 V DC or less (between comparative output and 0 V) Residual voltage: 2.4 V or less (at 50 mA sink current) 	PNP open-collector transistor <ul style="list-style-type: none"> Maximum source current: 50 mA or less Applied voltage: 26.4 V DC or less (between comparative output and +V) Residual voltage: 2.4 V or less (at 50 mA source current)
	Output modes	Output OFF mode, window comparator mode, hysteresis mode, integrated output mode, integrated pulse output mode	
Short-circuit protection	Incorporated		
Hysteresis	Window comparator mode: 1 to 8 % F.S. approx. (variable) (Factory settings: approx. 1 % F.S.), Hysteresis mode: Variable (minimum 1 digit)		
Response time	50 ms, 80 ms, 120 ms, 200 ms, 400 ms, 800 ms, 1,500 ms, selectable by key operation		
Analog voltage output	Output voltage: 1 to 5 V, Output impedance: 1 kΩ approx. [Refer to "Analog voltage output" (p.7) for more details.]		
Repeatability	Within ±1 % F.S.		
External input	ON voltage: 0 to +0.4 V OFF voltage: +5 V to +V, or open Input time: 80 ms or more	ON voltage: +5 V to +V OFF voltage: 0 to +0.6 V, or open Input time: 80 ms or more	
Linearity	Within ±3 % F.S. (Ambient temperature +25 °C +77 °F, flow rate range 3 to 100 % F.S., atmospheric criteria on secondary side)		
Display	4 digits + 4 digits 2-color LCD display (Display refresh rate: 250 ms, 500 ms, 1,000 ms, selectable by key operation)		
Environmental resistance	Protection	IP40 (IEC)	
	Ambient temperature	0 to +50 °C +32 to +122 °F (No dew condensation allowed), Storage: -10 to +60 °C +14 to +140 °F	
	Ambient humidity	35 to 90 % RH, Storage: 35 to 90 % RH	
	Voltage withstandability	1,000 V AC for one min. between all supply terminals connected together and enclosure (Excluding the aluminum body type)	
	Insulation resistance	10 MΩ, or more, with 500 V DC megger between all supply terminals connected together and enclosure (Excluding the aluminum body type)	
Vibration resistance / Shock resistance	10 to 150 Hz frequency, 0.75 mm 0.030 in amplitude or 49 m/s ² max. acceleration, in X, Y and Z directions for two hours each / 100 m/s ² acceleration (10 G approx.) in X, Y and Z directions for three times each		
Temperature characteristics	Within ±0.2 % F.S./°C (+25 °C +77 °F criteria, +15 to +35 °C +59 to +95 °F ambient temperature range)		
Pressure characteristics	Within ±5 % F.S. (-0.09 to +0.7 MPa, +25 °C +77 °F, atmospheric criteria on secondary side)		
Enclosure earthing	Floating (Note 4)		
Material	Enclosure: ABS, Body: Polyamide (Aluminum body type: Aluminum), Switch: EPDM, Display: Acrylic, Mounting screw part (Resin body type): Brass Current plate / port filter: Stainless steel (used for the gas contact area), Sensor chip: Silicon, Gasket: Fluorine rubber		
Connecting method	Connector		
Cable length	Total length up to 10 m 32.808 ft is possible with 0.3 mm ² , or more, cable.		
Accessory	CN-F15-C1 (Connector attached cable 1 m 3.281 ft): 1 pc.		

Notes: 1) Converted to volumetric flow at +20 °C +68 °F and 1 atmospheric pressure (101 kPa).

2) The display flow rate range is the case when setting to bi-direction at the flow direction setting. When the flow direction is set to one-side forward direction or one-side reverse direction, the negative side of the display flow rate range shows 10 % of the full-scale (F.S.).

3) The clean air complies with JIS B 8392-1.1.1 to 5.6.2, and the compressed air complies with JIS B 8392-1.1.1 to 1.6.2.

4) As a varistor (clamping voltage: approx. 40 V) is connected to the aluminum body type, do not apply voltage higher than the rated voltage of the sensor.

I/O CIRCUIT AND WIRING DIAGRAMS

FM-2□

NPN output type

I/O circuit diagram

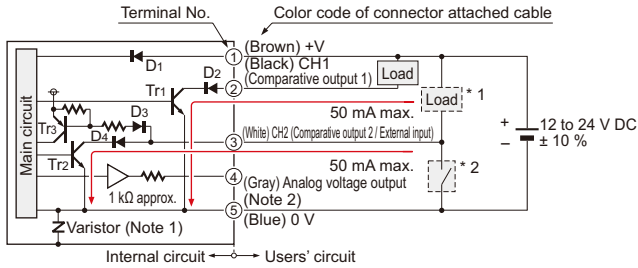

- Notes: 1) As for the aluminum body type, varistor (clamping voltage approx. 40 V) is connected between the internal power circuit and the metal body to prevent breakdown of the sensor. Connect the metal body to +V of power supply or to frame ground (F.G.) of a device that is connected to 0 V. High potential and insulation resistance tests between the internal power circuit and the metal body must not be done.
- 2) Short-circuit protection is not incorporated into the analog voltage output. Do not connect the power supply or capacitive load directly to the analog voltage output.

Symbols... D1 to D4 : Reverse supply polarity protection diode
Tr1, Tr2 : NPN output transistor
Tr3 : PNP input transistor

Wiring diagram

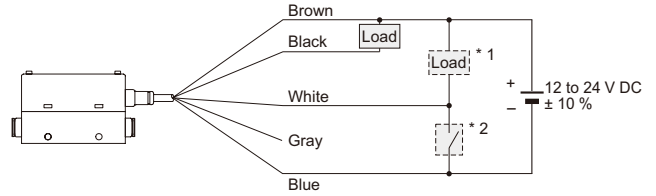

- * 1: When using CH2 as a comparative output 2
* 2: When using CH2 as an external input

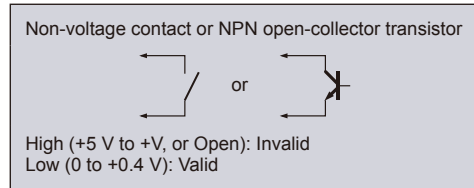

Analog voltage output

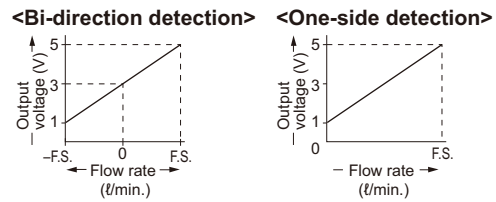

FM-2□-P

PNP output type

I/O circuit diagram

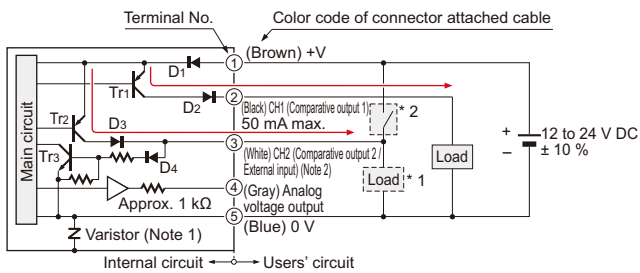

- Notes: 1) As for the aluminum body type, varistor (clamping voltage approx. 40 V) is connected between the internal power circuit and the metal body to prevent breakdown of the sensor. Connect the metal body to +V of power supply or to frame ground (F.G.) of a device that is connected to 0 V. High potential and insulation resistance tests between the internal power circuit and the metal body must not be done.
- 2) Short-circuit protection is not incorporated into the analog voltage output. Do not connect the power supply or capacitive load directly to the analog voltage output.

Symbols... D1 to D4 : Reverse supply polarity protection diode
Tr1, Tr2 : PNP output transistor
Tr3 : NPN input transistor

Wiring diagram

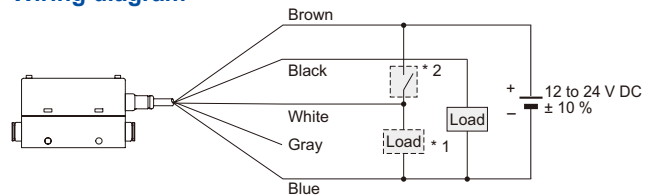

- * 1: When using CH2 as a comparative output 2
* 2: When using CH2 as an external input

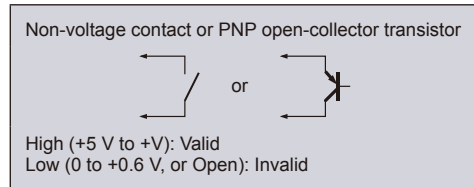

Analog voltage output

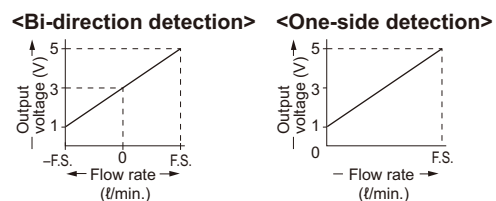

PRESSURE LOSS CHARACTERISTICS (TYPICAL)

FM-252-4(-P)

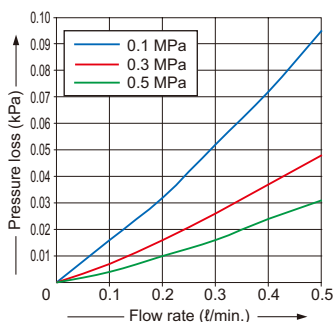

FM-213-4(-P)

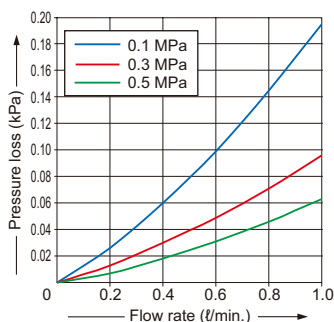

FM-253-4(-P)

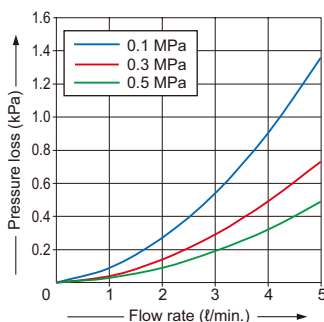

FM-214-4(-P)

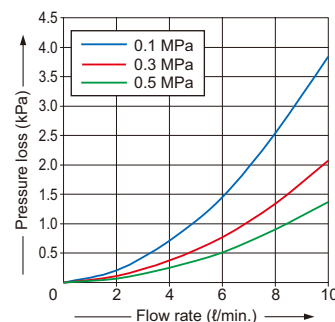

FM-254-8(-P)

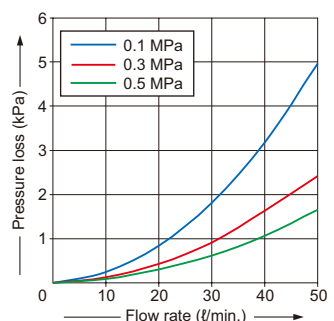

FM-215-8(-P)

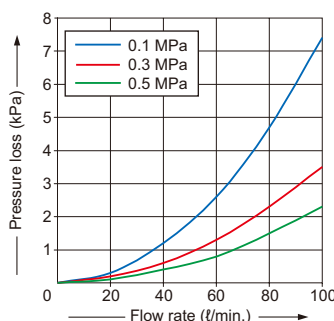

FM-255-A□2(-P)

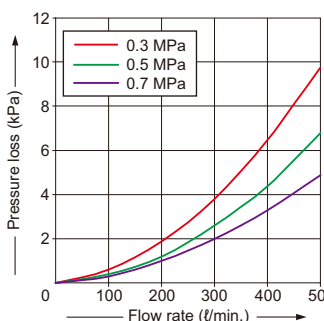

FM-216-A□2(-P)

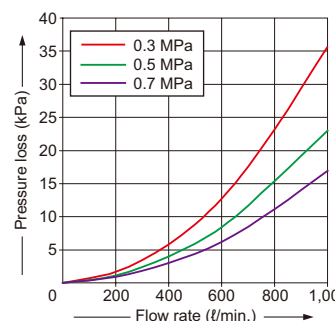

PRECAUTIONS FOR PROPER USE



- Never use this product as a sensing device for personnel protection.
- In case of using sensing devices for personnel protection, use products which meet laws and standards, such as OSHA, ANSI or IEC etc., for personnel protection applicable in each region or country.

Terminal arrangement diagram

Terminal arrangement of the connectors of this product (sensor body)

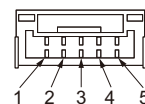

Part description

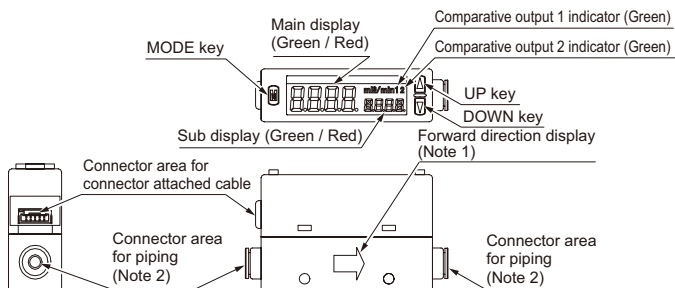

- Notes: 1) Direction of the arrow indicates the forward direction of flow rate when setting the flow direction to bi-direction or one-side forward direction. When setting the flow direction to one-side reverse direction, a direction opposite to the forward direction display will be the forward direction of the flow rate.
- 2) $\varnothing 4$ mm $\varnothing 0.157$ in push-in joint / $\varnothing 8$ mm $\varnothing 0.315$ in push-in joint is incorporated in FM-□-4 (-P) / FM-□-8 (-P), respectively. The push-in joint is not incorporated in the aluminum body type.

Connector pin No.	Color code of the connector attached cable	Terminal
1	Brown	+V
2	Black	CH1 (comparative output 1)
3	White	CH2 (comparative output 2 / external input)
4	Gray	Analog voltage output
5	Blue	0 V

PRECAUTIONS FOR PROPER USE

Mounting

- This product can be installed facing up or down or to the left or right.

Horizontal mounting

- Use M3 screws, and the tightening torque should be 0.5 N·m.

<Resin body type>

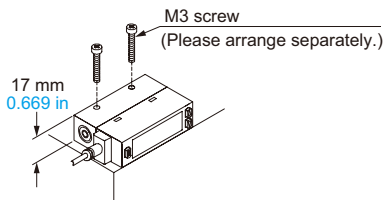

Vertical mounting

- Use M3 screws, and the tightening torque should be 0.5 N·m.

<Resin body type>

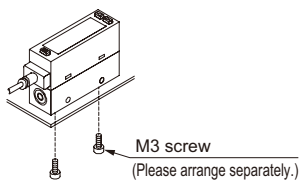

<Aluminum body type>

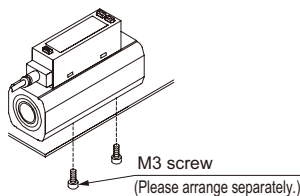

When using sensor mounting bracket

- When mounting the product on the sensor mounting bracket **MS-FM2-1** (optional) or **MS-FM2-2** (optional), use the M3 screws (length 6 mm **0.236 in**) attached to the sensor mounting bracket. The tightening torque should be 0.5 N·m. Use M3 screws to mount the sensor mounting bracket on a sensing surface.

<Resin body type>

Use MS-FM2-1

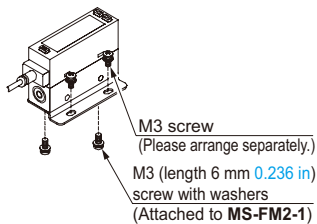

<Aluminum body type>

Use MS-FM2-2

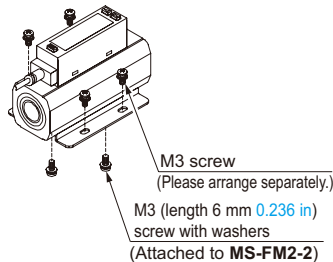

Piping

- The following specified tube should be used to insert to the push-in joint type product.

Material of tube	Tube diameter (mm in)	Allowable diameter
Polyamide	ø4 ø0.157 , ø8 ø0.315	Within ±0.1 mm ±0.004 in
	ø4 ø0.157	Within ±0.1 mm ±0.004 in
Polyurethane	ø8 ø0.315	Within +0.1 / -0.15 mm ±0.004 in / -0.006 in

- Before using this product, make sure to check that the tube is firmly inserted.

- Install a filter, an air dryer and an oil mist filter (micro-alescer) onto the primary side (upstream) of this product since the compressed air from the compressor contains drain (water, oil oxide and foreign materials, etc.). Mesh (wire net) in this product is used to rectify the flow in the pipe. Always install a filter to the primary side of this product since this mesh is not a filter to remove foreign materials.

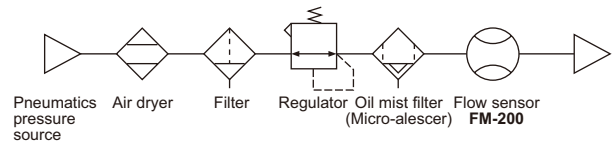

- When using a valve on the primary side of the product, only use an oil-prohibit specification valve. This product may malfunction or break if subject to splattering grease or oil, etc.
- When using this product for suction verification, etc., always install an air filter whose filtration property is 10 µm **0.394 mil** or less onto the suction side to prevent suction of foreign materials and water. Furthermore, consider atmospheric dew point and ambient temperature of the product, use the product under the conditions that dew condensations will not be formed in the inside of pipe.
- In case of mounting commercial joint to the aluminum body type, apply a spanner on the metal part of this product and tighten by the tightening torque of 16 to 18 N·m. If excessive torque is applied, the commercial joint or the main body may break.
- When piping, take care that foreign materials such as sealing tape and adhesive must not enter into the inside of the pipe. If foreign materials are entered, the product may malfunction or break.
- Make sure to mount the joint when using the product with its secondary side (downstream) open to the air. If the joint is not mounted, the port filter of the product may fall off.

Wiring

- Make sure that the power supply is OFF during wiring.
- Take care that wrong wiring will damage this product.
- Take care if applying voltage exceeding the rated range, or connecting to AC power supply, this product may break or burn.
- If power is supplied from a commercial switching regulator, ensure that the frame ground (F.G.) terminal of the power supply is connected to an actual ground.
- In case noise generating equipment (switching regulator, inverter motor, etc.) is used in the vicinity of this sensor, connect the frame ground (F.G.) terminal of the equipment to an actual ground.
- Do not run the wires together with high-voltage lines or power lines or put them in the same raceway. This can cause malfunction due to induction.
- Extension up to total 10 m **32.808 ft** is possible with 0.3 mm², or more, cable.
- Make sure that stress by forcible bend or pulling is not applied directly to the sensor cable joint.

Others

- This product has been developed / produced for industrial use only.
- This product is for use in air and nitrogen only. Do not use this product for other fluids since the sensing accuracy cannot be guaranteed.

PRECAUTIONS FOR PROPER USE

- Take care if foreign materials are mixed in the sensing part, the product may break.
- Do not use this product for commercial purposes since the product does not comply with International System of Units (SI).
- Do not apply pressure that exceed resistant-pressure.
- Do not use during the initial transient time (approx. 5 sec.) after the power supply is switched ON.
- The specifications may not be satisfied in a strong magnetic field.
- Accuracy of the display and the analog voltage output is influenced by self-heating by applying current other than

the temperature characteristics. Standby time (5 min. or more after applying current) should be taken when using the product.

- This product is suitable for indoor use only.
- Do not use this product in places having excessive vapor, dust, etc., or where it may come in contact with corrosive gas, etc.
- Take care that the product does not come in contact with water, oil, grease, or organic solvents such as thinner, etc., strong acid or alkaline.
- Do not drop the product or apply hard shock. This can cause product breakage.

FLOW SENSOR SELECTION

- If using a flow sensor for tasks such as checking suction and release from suction nozzles and sensing leaks, use the flow range setting table as a guide. The effective cross-section area of the nozzle (pinhole) and the difference in pressure inside and outside the nozzle can be used to calculate the flow.

<Calculation example>

The flow calculation value for a nozzle diameter of $\phi 0.1$ to $\phi 0.2$ mm $\phi 0.004$ to $\phi 0.008$ in when P2 is varied is shown in the table below.

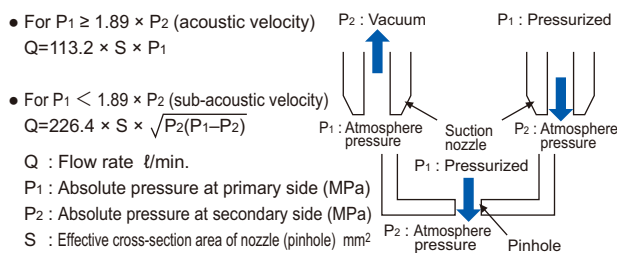

	P1(MPa) Absolute pressure	P1(MPa) Gauge pressure	P2(MPa) Absolute pressure	P2(MPa) Gauge pressure	Acoustic velocity / Sub-acoustic velocity	Calculated flow value (ℓ / min)									
						$\phi 0.1 \text{ mm}$ $\phi 0.004 \text{ in}$	$\phi 0.2 \text{ mm}$ $\phi 0.008 \text{ in}$	$\phi 0.3 \text{ mm}$ $\phi 0.012 \text{ in}$	$\phi 0.4 \text{ mm}$ $\phi 0.016 \text{ in}$	$\phi 0.5 \text{ mm}$ $\phi 0.020 \text{ in}$	$\phi 0.7 \text{ mm}$ $\phi 0.027 \text{ in}$	$\phi 1.0 \text{ mm}$ $\phi 0.039 \text{ in}$	$\phi 1.5 \text{ mm}$ $\phi 0.059 \text{ in}$	$\phi 2.0 \text{ mm}$ $\phi 0.079 \text{ in}$	
Suction	0.1013	0	0.0313	-0.07	Acoustic velocity	0.090	0.360	0.810	1.440	2.250	4.411	9.002	20.254	36.007	
	0.1013	0	0.0413	-0.06	Acoustic velocity	0.090	0.360	0.810	1.440	2.250	4.411	9.002	20.254	36.007	
	0.1013	0	0.0513	-0.05	Acoustic velocity	0.090	0.360	0.810	1.440	2.250	4.411	9.002	20.254	36.007	
	0.1013	0	0.0613	-0.04	Sub-acoustic velocity	0.088	0.352	0.792	1.408	2.200	4.312	8.800	17.249	35.202	
	0.1013	0	0.0713	-0.03	Sub-acoustic velocity	0.082	0.329	0.740	1.315	2.055	4.028	8.220	16.110	32.878	
	0.1013	0	0.0813	-0.02	Sub-acoustic velocity	0.072	0.287	0.645	1.147	1.792	3.512	7.166	14.046	28.666	
Blow (leakage detection)	0.1013	0	0.0913	-0.01	Sub-acoustic velocity	0.054	0.215	0.483	0.859	1.343	2.631	5.370	10.525	21.480	
	0.1113	0.01	0.1013	0	Sub-acoustic velocity	0.057	0.226	0.509	0.905	1.414	2.772	5.657	11.087	22.626	
	0.1213	0.02	0.1013	0	Sub-acoustic velocity	0.080	0.320	0.720	1.280	2.000	3.920	8.000	15.679	31.998	
	0.1413	0.04	0.1013	0	Sub-acoustic velocity	0.113	0.453	1.018	1.810	2.828	5.543	11.313	22.174	45.252	
	0.1613	0.06	0.1013	0	Sub-acoustic velocity	0.139	0.554	1.247	2.217	3.464	6.789	13.856	27.157	55.423	
	0.1813	0.08	0.1013	0	Sub-acoustic velocity	0.160	0.640	1.440	2.560	4.000	7.840	15.999	31.358	63.996	
	0.2013	0.1	0.1013	0	Acoustic velocity	0.179	0.716	1.610	2.862	4.472	8.765	17.888	40.248	71.552	
	0.3013	0.2	0.1013	0	Acoustic velocity	0.268	1.071	2.410	4.284	6.694	13.119	26.774	60.242	107.096	
	0.4013	0.3	0.1013	0	Acoustic velocity	0.357	1.426	3.209	5.706	8.915	17.474	35.660	80.236	142.641	
	0.5013	0.4	0.1013	0	Acoustic velocity	0.445	1.782	4.009	7.127	11.137	21.828	44.547	100.230	178.186	
0.6013	0.5	0.1013	0	Acoustic velocity	0.534	2.137	4.809	8.549	13.358	26.182	53.433	120.224	213.731		

- Notes: 1) In case of any leakage from tubes, etc., actual values will differ greatly from calculated values. When measuring flows, make sure that there is no leakage from any tubes.
 2) In case of any points in the tubes which are narrower than the diameter of the suction nozzle, flow will be restricted and may turn out to be lower than the calculated values.
 In addition, suction verification may not be possible in such cases.
 3) The effective cross-section area is a guide only. If the nozzle is long and narrow, the effective cross-section area may be smaller than the area at the tip of the nozzle.
 4) Response times are determined by the internal volume of the tube from the flow sensor to the suction nozzle (pinhole). If carrying out high-speed sensing, reduce the internal volume of the tube as much as possible such as by locating the flow sensor as close as possible to the suction nozzle.

DIMENSIONS (Unit:mm in)

The CAD data in the dimensions can be downloaded from the SUNX website: <http://www.sunx.com>

FM-2□-4(-P)

Sensor

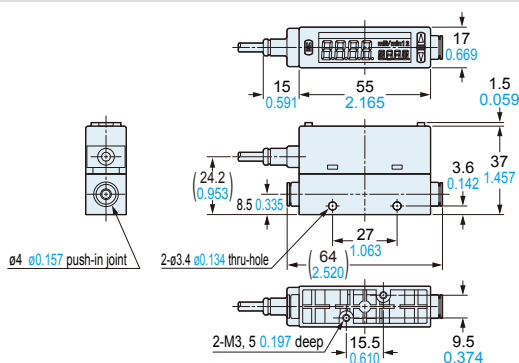

FM-2□-8(-P)

Sensor

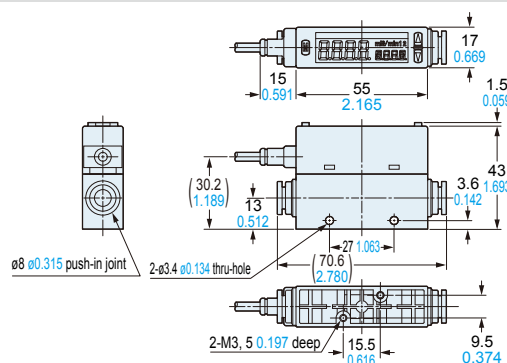

DIMENSIONS (Unit:mm in)

The CAD data in the dimensions can be downloaded from the SUNX website: <http://www.sunx.com>

FM-2□-A□(-P)

Sensor

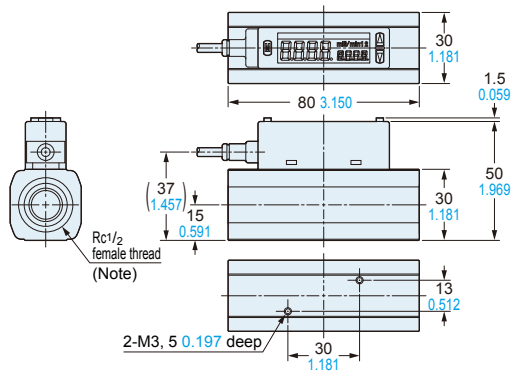

Note: FM-2□-AG2-P has G_{1/2} female thread.

CN-F15-C1

Connector attached cable (Optional)

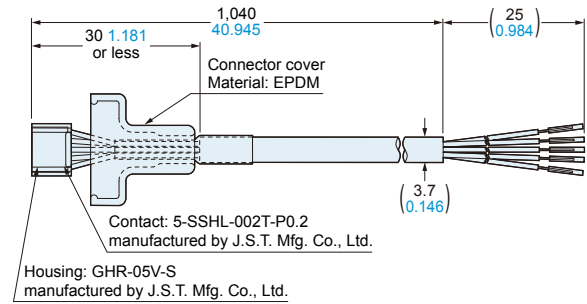

MS-FM2-1

Sensor mounting bracket (Optional)

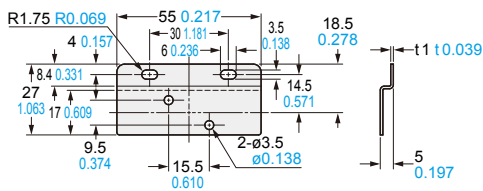

Material: Cold rolled carbon steel (SPCC)(Nickel plated)
Two M3 (length 6 mm 0.236 in) screws with washers are attached.

MS-FM2-2

Sensor mounting bracket (Optional)

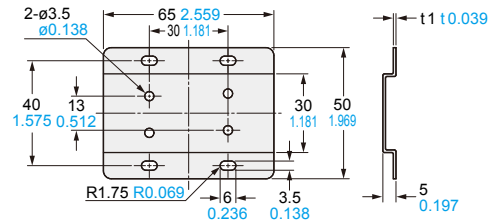

Material: Cold rolled carbon steel (SPCC)(Nickel plated)
Two M3 (length 6 mm 0.236 in) screws with washers are attached.

Assembly dimensions

Mounting drawing with FM-252-4

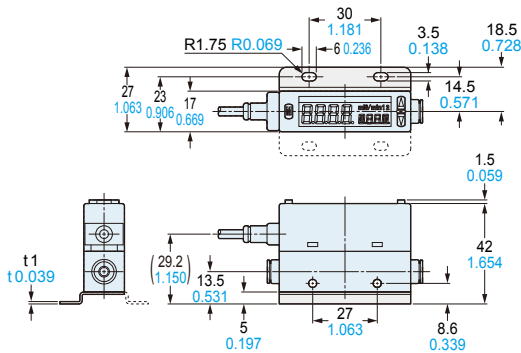

Assembly dimensions

Mounting drawing with FM-255-AR2

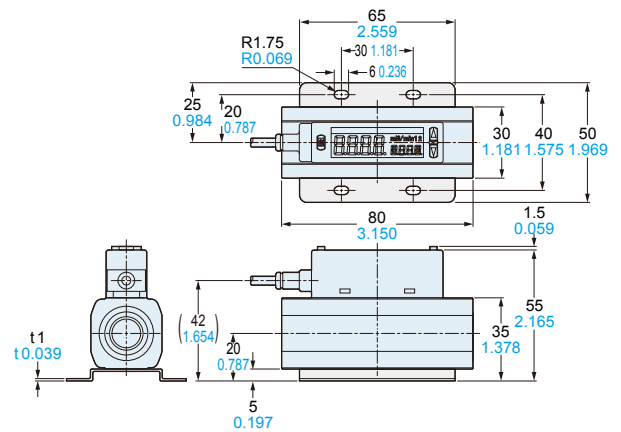

All information is subject to change without prior notice.

Panasonic Electric Works Europe AG

Rudolf-Diesel-Ring 2
83607 Holzkirchen
Deutschland
Tel.: +49(0)8024648-0 • Fax: +49(0)8024648-111
info.peweu@eu.panasonic.com
www.panasonic-electric-works.de

Panasonic[®]

Printed on recycled paper PRINTED IN JAPAN
No.CE-FM200-10 May, 2008