

TB 45 Temperature limiter/monitor



rail line

Operating manual

English

9499-040-93511

valid from: 02/2012



BlueControl®

More efficiency in engineering, more overview in operating:

The projecting environment for the BluePort® controllers, indicators and railline- measuring converters, universal controllers, temperature limiters



ATTENTION!
Mini Version and Updates on
www.pma-online.de
or on PMA-CD

Explanation of symbols:



General information



General warning



Caution: ESD-sensitive components



Caution: Read operating manual



Read operating manual



Hint

© 2004 • PMA Prozeß- und Maschinen-Automation GmbH • Printed in Germany
All rights reserved • No part of this document may be reproduced or published in any form
or by any means without prior written permission from the copyright owner.

A publication of
PMA Prozeß- und Maschinen Automation
P.O.Box 310229
D-34058 Kassel
Germany

Content

1. General	5
1.1 Application in thermal plants	6
2. Safety hints	7
2.1 Maintenance, repair, modification	8
2.2 Cleansing	8
2.3 Spare parts	8
3. Mounting	9
3.1 Connectors	10
4. Electrical connections	11
4.1 Connecting diagram	11
4.2 Terminal connections	11
4.3 Anschlussplan	13
4.4 Connection examples	14
4.5 Hints for installation	15
5. Operation	16
5.1 Front view	16
5.2 Operating structure	17
5.3 Behaviour after supply voltage switch-on	17
5.4 Displays at operating level	18
5.4.1 Display line 1	18
5.4.2 Display line 2	18
5.4.3 Switching over by means of the Enter key	19
5.5 Extended operating level	19
5.6 Release function	20
5.7 Unit selection	20
6. Functions	21
6.1 Limiting functions	21
6.1.1 Temperature limiter	21
6.1.2 Temperature monitor	22
6.1.3 Limit signaller	22
6.2 Linearization	22
6.3 Input scaling	23
6.3.1 Input error detection	24
6.3.2 Two-wire measurement	24
6.3.3 Connection Thermocouple	24
6.4 Filter	25
6.5 Limit value processing	25
6.5.1 Monitoring the number of operating hours and switching cycles	27
6.6 Analog output configuration	28
6.6.1 Analog output (optional)	28
6.6.2 Logic output (optional)	29
6.6.3 Transmitter supply (optional)	29
6.7 Maintenance manager / error list	30
6.7.1 Error list::	30
6.8 Reset to default	31

7. Configuration level	32
7.1 Configuration survey	32
7.2 Configuration	33
8. Parameter level	39
8.1 Parameter survey	39
8.2 Adjustment	39
8.3 Parameter level	40
9. Calibrating level	41
9.1 Offset correction	42
9.2 2-point correction	43
10. BlueControl engineering tool	44
11. Versions	45
12. Technical data	46
13. Index	50

1 General

Thank you very much for buying a TB 45 temperature monitor.

TB 45 temperature limiter are used for process monitoring. The units provide process value measurement, limit signalling and switch-off. Possible applications are heating and cooling processes. Configuration as an electronic temperature limiter, temperature monitor or as a limit signaller is possible.

A TB 45 offers one universal input, one limit contact and one pre-alarm contact. Optionally, the unit can be equipped with one universal output

Galvanic isolation of inputs and outputs, supply voltage and communication interfaces is provided.

Applications

TB 45 can be used as a

- certified temperature limiter/monitor to DIN 3440 / EN 14597
- or as a limit signaller for various process signals.

TB 45 as a DIN-certified temperature limiter/monitor (type2) can be used in systems in which exceeding of a defined temperature causes damage.

At-a-glance survey of advantages

Compact construction, only 22,5 mm wide

Clips onto top-hat DIN rail

Plug-in screw terminals or spring clamp connectors

Dual-line LC display with additional display elements

Process values always in view

Convenient 3-key operation

Direct communication between rail-mounted transmitters

Universal input with high signal resolution (>14 bits) reduces stock keeping

Universal output with high resolution (14 bits) as combined current / voltage output

Quick response, only 100 ms cycle time

Usable as temperature limiter/monitor or as general limit indicator

Customer-specific linearization

Measurement value correction (offset or 2-point)

Second analog input for differential measurement, oxygen direct-measurement etc.

Further documentation for temperatur limiter TB 45:

- Datasheet TB 45 9498 737 48413
- Operating hint TB 45 9499 040 93641
- Interface description 9499 040 72011

1.1

Application in thermal plants

In many thermal plants, only the use of approved control instruments is permissible.

The TB 45 version (TB45-2xx-xxxx-Dxx) meets the requirements as an electronic temperature limiter/monitor (TB/TW, type 2.B.J.V) according to DIN 3440 and EN 14597.

This version is suitable for use in heat generating plants, e.g. in

- **building heating systems acc. to DIN EN 12828 (formerly DIN 4751)**
- **large water boilers acc. to DIN EN 12953-6 (formerly DIN 4752)**
- **heat conducting plants with organic heat transfer media acc. to DIN 4754**
- **oil-fired plants to DIN 4755**

...

Temperature monitoring in water, oil and air is possible by means of suitable approved probes.

2

Safety hints

This unit was built and tested in compliance with VDE 0411-1 / EN 61010-1 and was delivered in safe condition. The unit complies with European guideline 89/336/EEG (EMC) and is provided with CE marking. The unit was tested before delivery and has passed the tests required by the test schedule. To maintain this condition and to ensure safe operation, the user must follow the hints and warnings given in this operating manual.



The unit is intended exclusively for use as a measurement and control instrument in technical installations.

**Warning**

If the unit is damaged to an extent that safe operation seems impossible, the unit must not be taken into operation.

ELECTRICAL CONNECTIONS

The electrical wiring must conform to local standards (e.g. VDE 0100). The input measurement and control leads must be kept separate from signal and power supply leads.

In the installation of the unit a switch or a circuit-breaker must be used and signified. The switch or circuit-breaker must be installed near by the unit and the user must have easy access to the unit.

COMMISSIONING

Before instrument switch-on, check that the following information is taken into account:

- **Ensure that the supply voltage corresponds to the specifications on the type label.**
- **All covers required for contact protection must be fitted.**
- **If the unit is connected with other units in the same signal loop, check that the equipment in the output circuit is not affected before switch-on. If necessary, suitable protective measures must be taken.**
- **The unit may be operated only in installed condition.**
- **Before and during operation, the temperature restrictions specified for unit operation must be met.**

**Warning**

The instrument is intended for mounting in an enclosure. Its contact safety is ensured by installation in a housing or switch cabinet.

**Warning**

The ventilation slots must not be covered during operation.



The measuring inputs are appropriate for the measurement of electric circuits, which are not directly (CAT I) connected with the supply network. The measuring entrances are appropriate for transient overvoltage to 800V against PE.

SHUT-DOWN

For taking the unit out of operation, disconnect it from all voltage sources and protect it against accidental operation. If the unit is connected with other equipment in the same signal loop, check that other equipment in the output circuit is not affected before switch-off. If necessary, suitable protective measures must be taken.

2.1 Maintenance, repair, modification

The units do not need particular maintenance.
There are no operable elements inside the device, so the user must not open the unit
Modification, maintenance and repair work may be done only by trained and authorized personnel. For this purpose, the PMA service should be contacted.



Warning

When opening the units, or when removing covers or components, live parts and terminals may be exposed. Connecting points can also carry voltage.



Caution

When opening the units, components which are sensitive to electrostatic discharge (ESD) can be exposed. The following work may be done only at workstations with suitable ESD protection. Modification, maintenance and repair work may be done only by trained and authorized personnel. For this purpose, the PMA service should be contacted.



You can contact the PMA-Service under:

PMA Prozeß- und Maschinen-Automation GmbH
Miramstraße 87
D-34123 Kassel

Tel. +49 (0)561 / 505-1257
Fax +49 (0)561 / 505-1357
e-mail: mailbox@pma-online.de

2.2 Cleansing



The cleaning of the front of the unit should be done with a dry or a wetted (spirit, water) handkerchief.

2.3 Spare parts

As spare parts für the devices the following accessory parts are allowed:

Description	Order-No..
Connector set with screw terminals	9407-998-07101
Connector set with spring-clamp terminals	9407-998-07111
Bus connector for fitting in top-hat rail	9407-998-07121

3 Mounting

Abmessungen / dimensions

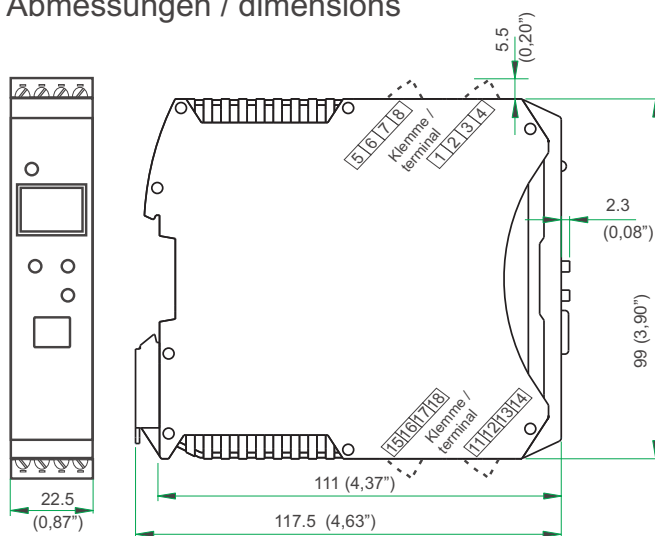

max. 55°C
min. -10°C

max. 95% rel. %
%

Montage / mounting

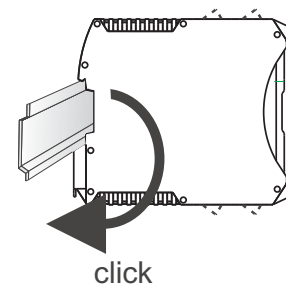

Demontage / dismantling

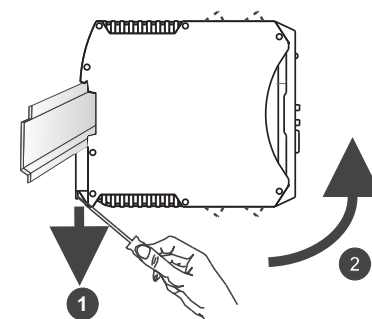

The unit is provided for vertical mounting on 35 mm top-hat rails to EN 50022.

If possible, the place of installation should be exempt of vibration, aggressive media (e.g. acid, lye), liquid, dust or aerosol.

The instruments of the *rail line* series can be mounted directly side by side. For mounting and dismantling, min. 8 cm free space above and below the units should be provided.

For mounting, simply clip the unit onto the top-hat rail from top and click it in position.

To dismantle the unit, pull the bottom catch down using a screwdriver and remove the unit upwards.



TB 45 temperature limiter does not contain any maintenance components and need not be opened by the customer.



The unit may be operated only in environments for which it is suitable due to its protection type.



The housing ventilation slots must not be covered.



In plants where transient voltage peaks are susceptible to occur, the instruments must be equipped with additional protective filters or voltage limiters!



Caution! The instrument contains electrostatically sensitive components.



Please, follow the instructions given in the safety hints.



For maintaining contamination degree 2 to EN 61010-1, the unit must not be installed below contactors or similar equipment from which conductant dusts or particles are susceptible of trickling down.

3.1

Connectors

The four instrument connectors are of the plug-in type. They plug into the housing from top or bottom and click in position (audible latching). Releasing the connectors should be done by means of a screwdriver.

Two connector types are available:

- **Screw terminals for max. 2,5 mm² conductors**
- **Spring-clamp terminals for max. 2,5 mm² conductors**



Before handling the connectors, the unit must be disconnected from the supply voltage.

Tighten the screw terminals with a torque of 0,5 - 0,6 Nm.

With spring-clamp terminals, stiff and flexible wires with end crimp can be introduced into the clamping hole directly. For releasing, actuate the (orange) opening lever.



Contact protection: Terminal blocks which are not connected should remain in the socket.



Standard wires must be terminated with cable terminal sleeves.

4 Electrical connections

4.1 Connecting diagram

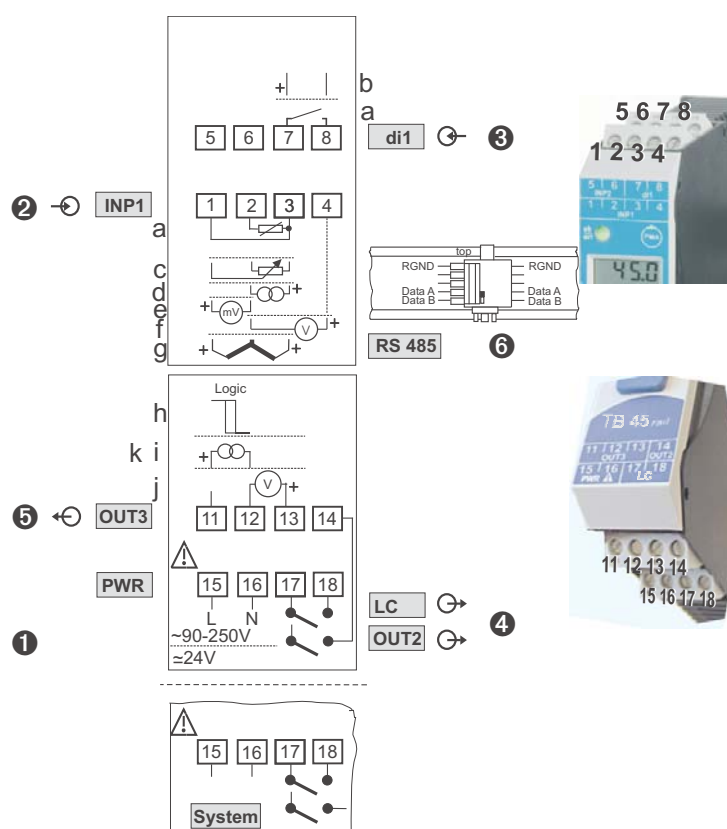

4.2 Terminal connections



Faulty connection can lead to the destruction of the instrument.

1 Connecting the supply voltage

Dependent on order

- 90 ... 250 V AC
- 24 V AC / DC

terminals: 15,16
terminals: 15,16

For further information, see section 12 "Technical data"



Instruments with optional system interface:

Energization is via the bus connector of field bus coupler or power supply module. Terminals 15, 16 must not be used.

2 Connecting input INP1

Input for the measurement value

- a** resistance thermometer (Pt100/ Pt1000/ KTY/ ...), 3-wire connection
- c** potentiometer
- d** current (0/4...20mA)
- e** voltage (-2,5...115/-25...1150/-25...90/ -500...500mV)
- f** voltage (0/2...10V/ -5...5V))
- g** thermocouple (standard connection; temperature monitor, limit signaller)
thermocouple (double thermocouple, temperature limiter)

terminals: 1, 2, 3
terminals: 1, 2, 3
terminals: 2, 3
terminals: 1, 2
terminals: 2, 4
terminals: 1, 2
terminals: 1, 2, 3

③ Connecting input di1

Digital input, configurable as a switch or a push-button.

- | | | |
|----------|------------------------------|-----------------|
| a | contact input | terminals: 7, 8 |
| b | optocoupler input (optional) | terminals: 7, 8 |

④ Connecting output LC / OUT2

Relay outputs max. 250V/2A as closer with shared contact connection.

- | | | |
|---|------|-------------------|
| • | LC | terminals: 17, 18 |
| • | OUT2 | terminals: 17, 14 |

⑤ Connecting output OUT3

Universal output

- | | | |
|----------|--------------------------|-------------------|
| h | logic (0..20mA / 0..10V) | terminals: 11, 12 |
| i | current (0..20mA) | terminals: 11, 12 |
| j | voltage (0..10V) | terminals: 12, 13 |
| k | transmitter power supply | terminals: 11, 12 |

⑥ Connecting the bus interface (optional)

RS 485 interface with MODBUS RTU protocol

* see interface description MODBUS RTU: (9499-040-72011)

4.3 Connecting diagram

The instrument terminals used for the engineering can be displayed and printed out via BlueControl® (menu File \ Print preview - Connection diagram).

Example:

Connection diagram		
terminal row 1		
pin	description	Description
1	INP1 TC+	measurement X1, TC type J (-100...1200°C)
2	INP1 TC-	
3	INP1 TC+	
4	—	
5	—	
6	—	
7	di1 contact	reset error list
8	di1 contact	

terminal row 2		
pin	description	Description
11	OUT3 +I	0 ... 20 mA continuous, process value
12	OUT3 -I	
13	—	
14	OUT2	signal limit 2, signal INP1 fail
15	PWR L 24V AC/DC	
16	PWR N 24V AC/DC	
17	LC / OUT2	
18	LC	limitcontact

terminal row 3		
pin	description	Description
BC1	RS485	RGND
BC2	NC	
BC3	NC	
BC4	RS485	Data A
BC5	RS485	Data B

4.4

Connection examples

Connection example: KS 45 and TB 45

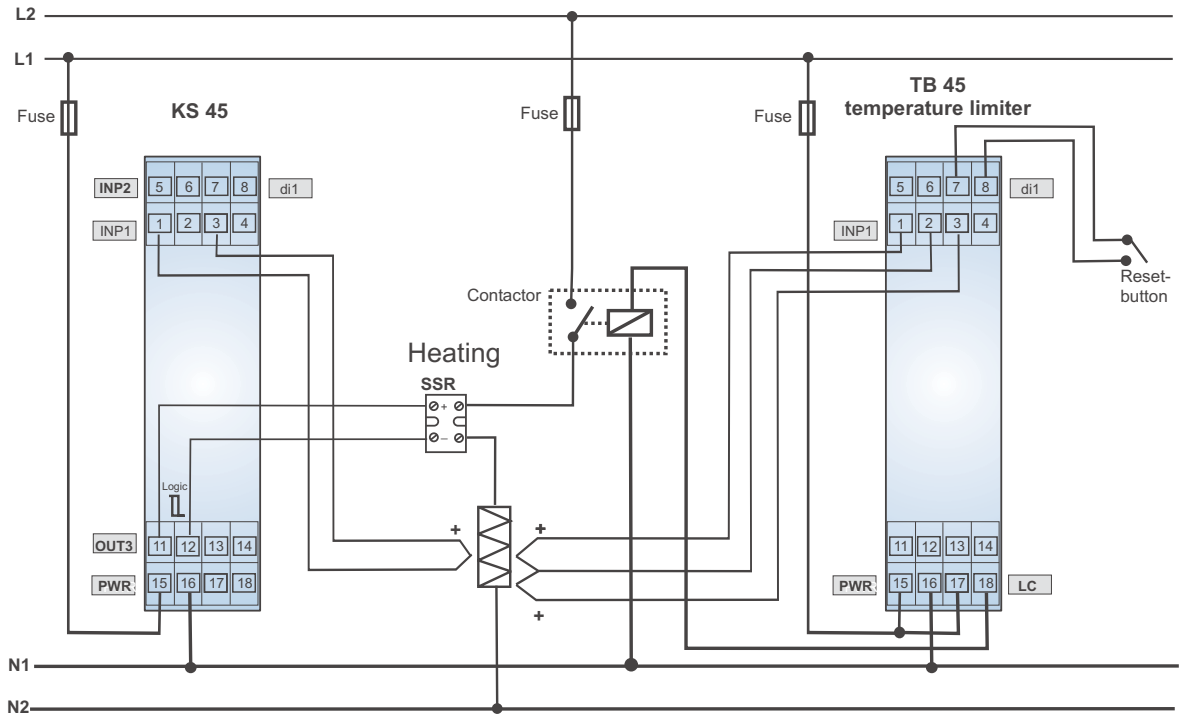

Example: RS 485 interface with RS 485-RS 232 converter
See documentation 9499-040-72011

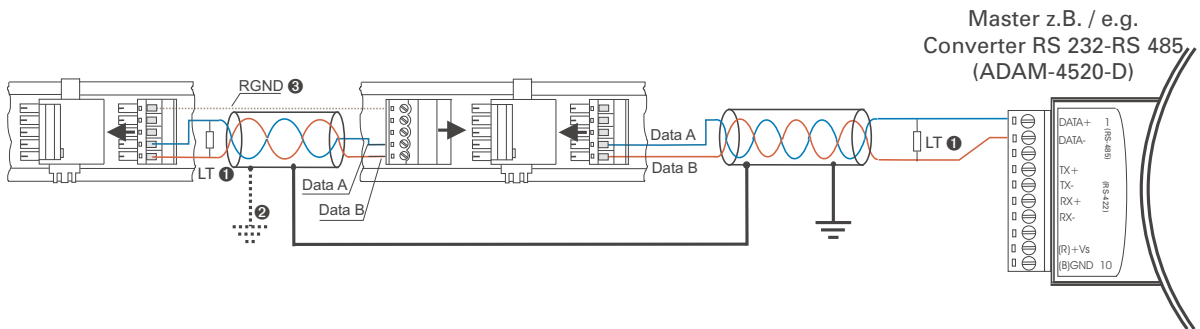

4.5**Hints for installation**

- Measurement and data lines should be kept separate from control and power supply cables.
- Sensor measuring cables should be twisted and screened, with the screening connected to earth.
- External contactors, relays, motors, etc. must be fitted with RC snubber circuits to manufacturer specifications.
- The unit must not be installed near strong electric and magnetic fields.
- The temperature resistance of connecting cables should be selected appropriately for the local conditions.



The unit is not suitable for installation in explosion-hazarded areas.



Faulty connection can lead to the destruction of the instrument.



The measuring inputs are designed for measurement of circuits which are not connected directly with the local mains (CAT I). The measuring inputs are designed for transient voltage peaks up to 800 V against PE.



Please, follow the instructions given in the safety hints (see page 7).

5 Operation

5.1 Front view

- ❶ Display line 1: process value or limit value LC
 - ❷ Display line 2: limit value LC / unit / extended operating level/ error list
 - ❸ Operation mode "Temperature limiter"
 - ❹ Error list (2 x ←), e.g.
 - *FbF* . x sensor fault INP. X
 - *ShL* . x short circuit INP. X
 - *Pol* . x wrong polarity INP. X
 - *Lim* . x limit value alarm
 - ...
 - ❺ Increment key
 - ❻ Enter key to select extended operating level or error list
 - ❼ Status indicator LEDs
 - green: limit value 1 OK
 - green blinking: no data exchange with bus coupler (only on instruments with optional system interface)
 - red: limit value 1 active
 - red blinking: instrument fault
 - ❽ Display elements, active as bars
 - ❾ Status of switching output LC active
 - ❿ Status of switching output OUT2 active
 - ⓫ Decrement key
 - ⓬ PC connection for the **BlueControl**[®] engineering tool
- ⓪ + ⓫: The error list can be reset by pressing this key combination.

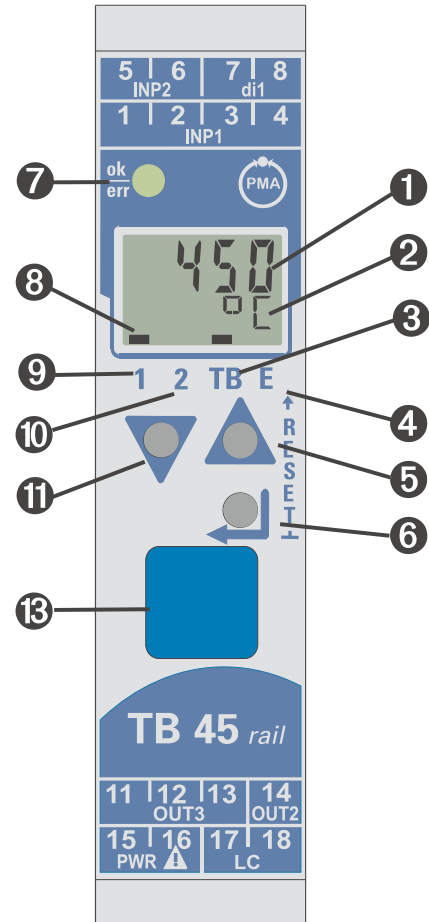

In the first LCD-display line the measured value or limit value is shown (parameterizable). The second LCD-line normally shows the limit value LC. When changing over to the parameter setting, configuration or calibration level and at the extended operating level, the parameter name and value are displayed alternately.



⓬ : To facilitate withdrawal of the PC connector from the instrument, please, press the cable left.

5.2 Operating structure

Operation of the unit is divided into four levels:

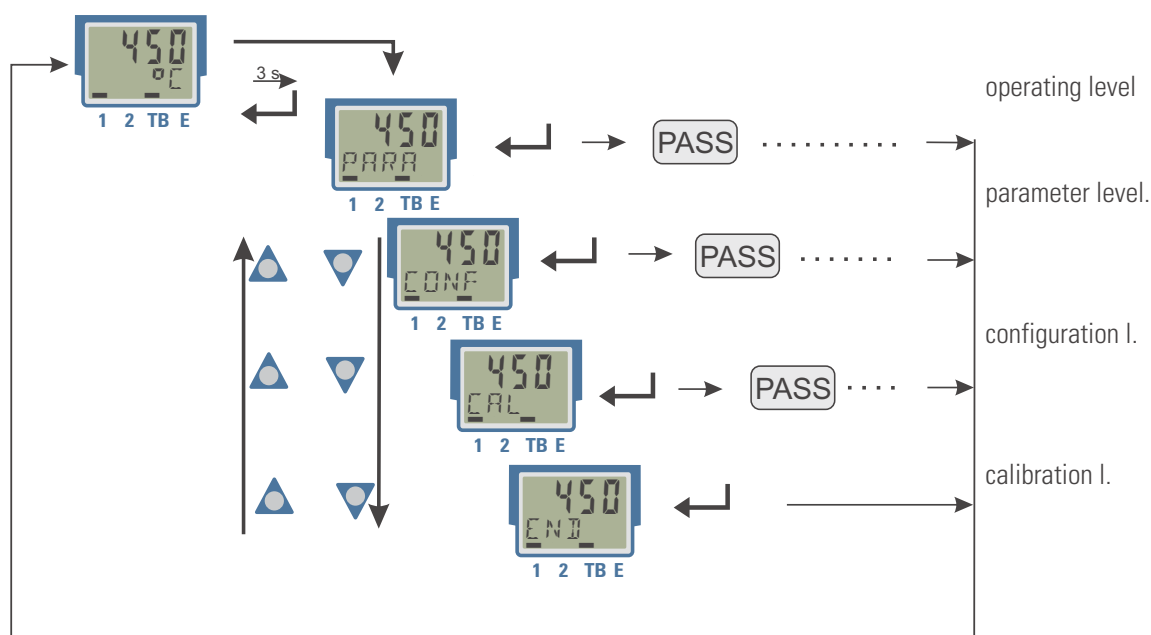

With TB 45, access to parameter setting, configuration and calibration level is protected by a password.

- The access to a level can be disabled by entry of a pass number (0 ... 9999). After entry of the adjusted pass number, all values of the level are available. With faulty input, the unit returns to the operating level. Adjusting the pass number is done via BlueControl®.
- Additionally, display suppression of particular instrument levels is possible by adjustments in the engineering tool (IPar, IConf, ICal).

PASS

Individual parameters which must be accessible without pass number, or from a disabled parameter level, must be copied into the extended operating level.



Value changing at the extended operating level is not possible with temperature limiter/monitor function selected.

Factory-setting: all levels are accessible without restrictions,
pass number `PASS = 45`

5.3 Behaviour after supply voltage switch-on

After switching on the supply voltage, the instrument starts with the operating level. The operating status is as before power-off.

5.4 Displays at operating level

5.4.1 Display line 1

The value shown on display line 1 can be determined by configuration Dis1. This configuration is adjustable only via BlueControl®. The following values can be displayed:

- process value (default)
- limit value LC

The display value, which is also called process value, is the value resulting from function 1. Normally, this is input value 1.

5.4.2 Display line 2

The value to be displayed continuously in the second LCD line can be selected from different values via the BlueControl® engineering tool.

Normally the internal limit value $LC = 5 \text{ SET}$.

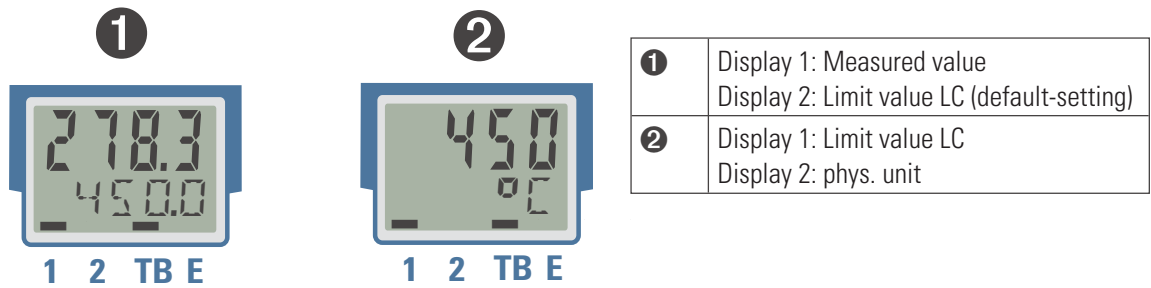

Delete the entry for display line 2 to return to limit value display.



With faulty input values, signals dependent on the inputs (e.g. Inp1, display value, Out3) also indicate FAIL.

5.4.3 Switching over by means of the Enter key

Various values can be called up on display line 2 by pressing the Enter key.

- ❶ The value defined for display line 2 (via BlueControl®);
Basic setting is limit value LC.
- ❷ Display of the error list, if it contains entries.
With several entries, the following value is displayed
when pressing the Enter key.
- ❸ Display of extended operating level, if it contains
entries. With several entries, the following value is
displayed when pressing the Enter key.
- ❹ Return to standard display
Unless a key is pressed during 30 s, the display returns to standard.

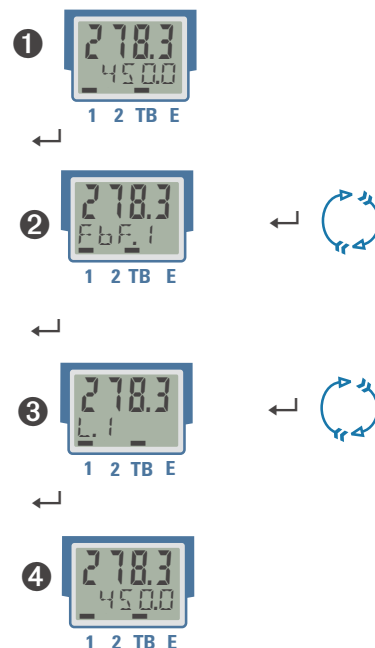

5.5 Extended operating level

The operation of important or frequently used parameters and signals can be allocated to the extended operating level.

This facilitates the access, e.g. travelling through long menu trees is omitted, or only selected values are operable, the other data of the parameter level are e.g. disabled.

Display of the max. 8 available values of the extended operating level is in the second LCD line.

The content of the extended operating level is determined by means of the **BlueControl®** engineering tool. For this, select entry "Operation level" in the "Mode" selection menu. Further information is given in the on-line help of the engineering tool.



Value changing at the extended operating level is not possible with temperature limiter/monitor function selected.

Press key \leftarrow to display the first value of the extended operating level (after display of error list, if necessary).

The selected parameters can be changed by pressing keys \blacktriangledown and \blacktriangle .

\leftarrow press to display the next parameter

\leftarrow return to normal display after the last parameter

Unless a key is pressed within a defined time (timeout = 30 s), the operating level is displayed again.

- ❶ Value changing at the extended operating level can be disabled via **BlueControl** setting : Configuration / Other / lexo = 1 .

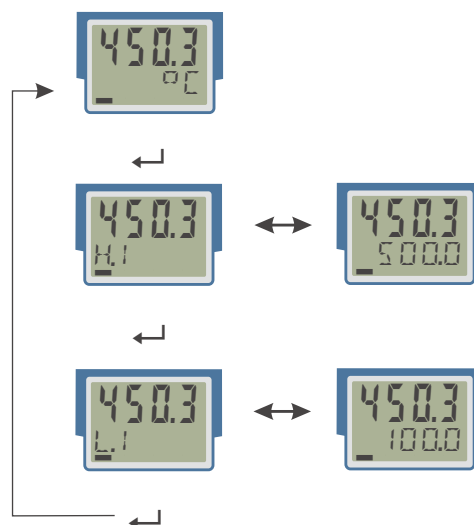

5.6

Release function

The following settings for error list resetting or limiting function releasing are available:

- **Resetting via digital input di1**
- **Resetting by pressing key combination Enter + Increment**

In the second case, press the Enter key first and keep it pressed whilst pressing the Increment key.



Pending alarms or error messages cannot be released.



Please, note that the output or outputs are released when actuating the reset function.

The reset key combination can be disabled by means of a password (adjustment via BlueControl®: Configuration / Others / IRES = 1).

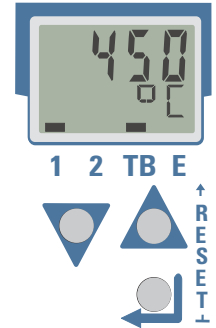

5.7

Unit selection

The display unit is determined via configuration *Unit* .

When selecting value “1 = temperature unit”, the displayed unit is determined by configuration of *Unit* and by the relevant conversions for Fahrenheit and Kelvin.

Definition of any max. 5-digit unit or of a text is possible by selecting *Unit* = 22 .



1



2

1	Unit (example): kilowatt hour
2	Text (example): TAG no.



For permanent display, set value Signals/Others/D.Unt into display line 2 in mode “Operating level” in the engineering tool.

6 Functions

The signal data flow of temperature limiter TB 45 is shown in the following diagram:

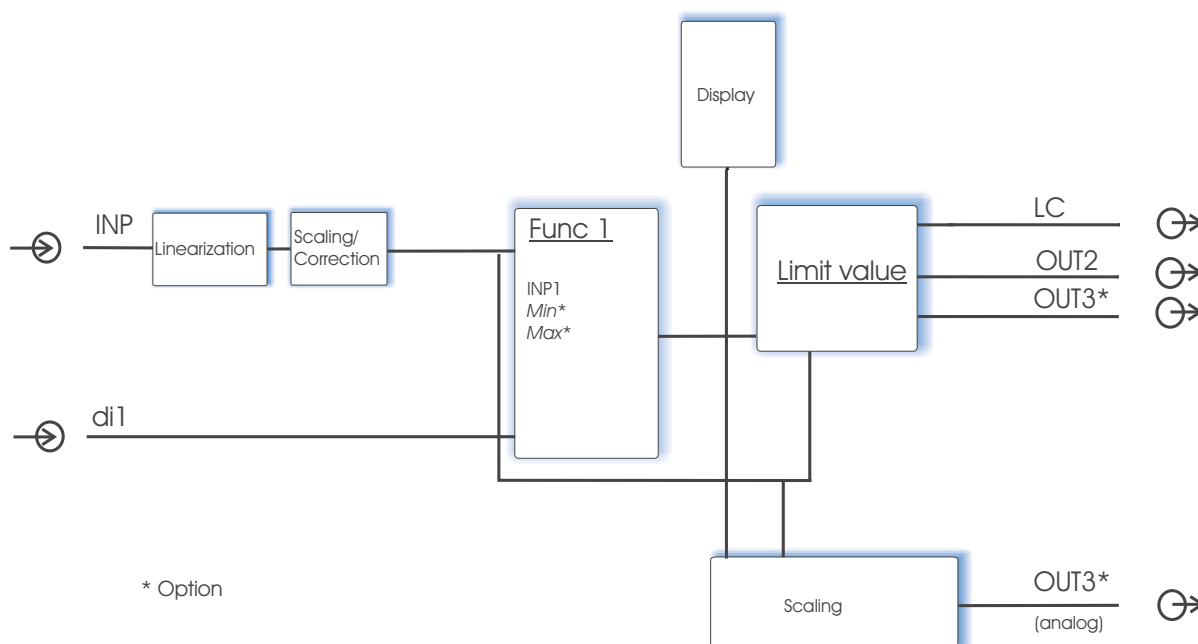

6.1 Limiting functions

TB 45 can be configured for various functions:

- as a temperature limiter
- as a temperature monitor
- as a limit signaller

6.1.1 Temperature limiter

If selected, a temperature limiter function monitors the process value. When exceeding the (configurable) low or high limit value LC, the output relay LC is opened and disabled.

Releasing is possible only, when

- the process value is below the adjusted high limit value LC (minus any adjusted hysteresis) again with setting "Temperature limiter max. (latch)", or when the process value is above low limit value LC (plus any adjusted hysteresis) again with setting "Temperature limiter min. (latch)".
- reset via digital input di1 or via the reset key combination (selectable) occurred. The reset key combination can be disabled by means of a password (setting in BlueControl®: Configuration / Others / IRES = 1).



When display element TB is lit, a temperature limiter function is selected.



Please, note that the adjusted filter time $t.F1$ can increase the response time for the process value. The DIN-tested response times were tested with $t.F1 = 0,5$ s.

Limit values Lim.2, Lim.3 can be used as pre-alarms for (optional) output on OUT.2, OUT.3.

6.1.2 Temperature monitor

The selected temperature monitor function monitors the process value. When the process value is above the adjusted high limit value LC or below the adjusted low limit value LC (configurable), output relay LC is opened and disabled.

Release is automatic, when

- the process value is below the adjusted high limit value LC (minus any adjusted hysteresis) again with setting “Temperature monitor max.”, or when the process value is above the adjusted low limit value LC (plus any adjusted hysteresis) again with setting “Temperature monitor min.”.



Please, note that the adjusted filter time $t.F1$ can increase the response time for the process value. The DIN-tested response times were tested with $t.F1 = 0,5$ s.

Limit values Lim.2, Lim.3 can be used as pre-alarms for (optional) output on OUT.2, OUT.3.

6.1.3 Limit signaller

A selected limit signalling function monitors the process value. When exceeding the adjusted limit values L.1 / H.1 , output relay LC is opened (see also chapter Limit values!)

Limit values Lim.2, Lim.3 can be used as pre-alarms for (optional) output on Out.2, Out.3.

6.2 Linearization

The input values of input INP1 can be linearized via a table (dependent from adjusted sensor type $S.tYP$).

By means of tables, e.g. special linearizations for thermocouples or other non-linear input signals, e.g. a container filling curve, are possible.

The “ L_{in} ” table is always accessed, when at INP1 with sensortype $S.tYP = 18$: “special thermocouple” or with linearization $S.L_{in} = 1$: “special linearization” is selected .

- The input signals must be specified in mV, V, mA, % or Ohm dependent on input type.
- For special thermocouples ($S.tYP = 18$), specify the input values in μV , and the output values in the temperature unit adjusted in U.LinT .
- For special resistance thermometer (KTY 11-6) ($S.tYP = 23$), specify the input values in Ohm, and the output values in the temperature unit adjusted in U.LinT.

Non-linear signals can be linearized using up to 16 segment points. Each segment point comprises an input ($I_{in,1} \dots I_{in,16}$) and an output ($O_{out,1} \dots O_{out,16}$). These segment points are interconnected automatically by straight lines. The straight line between the first two segment points is extended downwards and the straight line between the two highest segment points is extended upwards, i.e. a defined output value for each input value is provided.

With an $I_{in,x}$ value switched to OFF , all further segments are switched off.



Condition for the input values is an ascending order.

$$I_{in,1} < I_{in,2} < \dots < I_{in,16}$$



For linearization of special thermocouples, the ambient temperature range should be defined exactly, because it is used to derive the internal temperature compensation.



See also page 38.

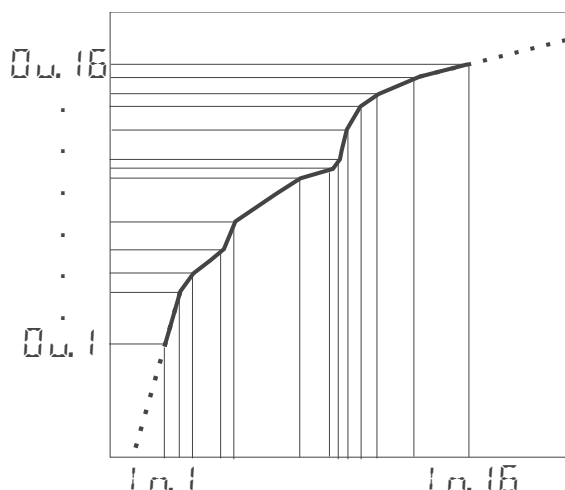

The linearization table is used for input 1

6.3

Input scaling

Scaling of input values is possible. After any linearization, measurement value correction is according to the offset or two-point method.



When using current or voltage signals as input variables for $InP.x$, the input and display values should be scaled at the parameter level. Specification of the input value of the lower and upper scaling point is in units of the relevant physical quantity.

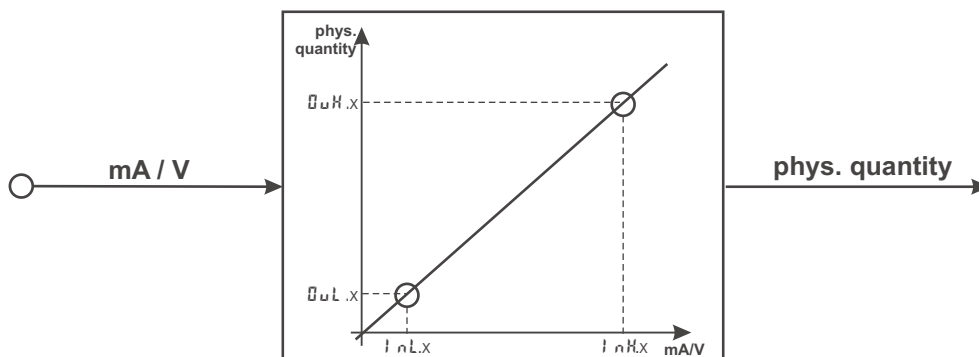

Example for mA/V



Parameters InL , OuL , InH and OuH are visible only with $Conf/InP/Corr = 3$ selected.

Parameters InL and InH determine the input range.

Example with mA:

$InL = 4$ and $InH = 20$ means that measuring from 4 to 20 mA is required (life zero setting).



For using the pre-defined scaling with thermocouples and resistance thermometers (Pt100), the settings for I_{inL} and Q_{inL} as well as for I_{inH} and Q_{inH} must correspond with each other.



For resetting the input scaling, the settings for I_{inL} and Q_{inL} as well as I_{inH} and Q_{inH} must correspond.

6.3.1 Input error detection

For life zero detection of connected input signals, variable adjustment of the response value for FAIL detection is possible according to formula:

$$\text{Fail response value} = I_{inL} - 0,125 * (I_{inH} - I_{inL})$$

Example 1: $I_{inL} = 4 \text{ mA}$, $I_{inH} = 20 \text{ mA}$
Fail response value $\leq 2 \text{ mA}$

Example 2: $I_{inL} = 2 \text{ V}$, $I_{inH} = 6 \text{ V}$
Fail response value $\leq 1,5 \text{ V}$

6.3.2 Two-wire measurement

Normally, resistance and resistance thermometer measurement is in three-wire connection, whereby the resistance of all leads is equal.

With two-wire measurement, the lead resistance is included directly as a falsification in the measurement result. However, determination of the lead resistances by means of is possible.



Besides the connection of the both leads of the RTD / R sensor the 3rd connector has to be short-circuited.

Procedure with Pt100, Pt1000

Connect a Pt100 simulator or a resistance decade instead of the sensor at the test point so that the lead resistance is included and calibrate the values by means of 2-point correction.



By means of measurement value correction the resulting temperature value will be corrected, but not the resistance input value. In this case the linearization error can increase.

Procedure with resistance measurement

Measure the lead resistance with an ohmmeter and subtract it from the measured value via the scaling.

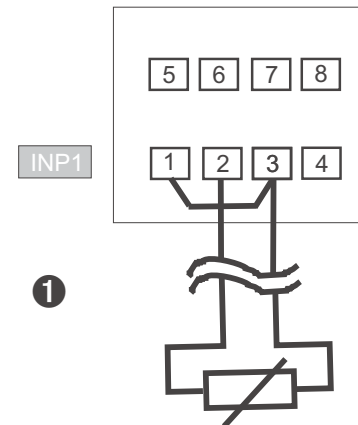

6.3.3 Connection Thermocouple

If the device is used as a temperature limiter, a double thermocouple must be connected. For measurements in the area of ambient temperature (0mV) the plausibility is ensured by the control of the 2nd thermocouple. Outside of this range there is no check of the 2nd thermocouple.

If the device is used as a temperature monitor or limit signaller, no double thermocouple should be connected. There is no plausibility check. (See connecting diagram Chapter 4.1)

6.4

Filter

A first order mathematic filter can be used for the input values. The time constant is adjustable. This low-pass filter is used for suppression of process-dependent interference on the input leads. The higher the value, the better the filter effect, but the longer the input signal delay.



Please, note that the adjusted filter time $t.F1$ can increase the response time for the process value. The DIN-tested response times were tested with $t.F1 = 0,5$ s.

monitoring is possible via the limit values.

6.5

Limit value processing

The main alarm acts on the process value and is firmly allocated to relay output LC the output action of which is set to inverse continuously. With the temperature limiter/monitor function, the limit value is adjusted by means of parameter LC. With the limit signaller function, the limit value is adjusted via $L.L$ / $H.L$. The limit value switching difference $H.Y.S.L$ is adjustable.

Max. two further limit values can be configured as pre-alarms and allocated to the individual outputs $Q.L.2$, $Q.L.3$.

Several signals assigned to an output are logically ORed.



The signal to be monitored can be selected separately for each alarm via configuration. The following signals are available:

Main alarm LC

- **Process value (display value)**

Pre-alarms Lim.2 / Lim.3

- **Process value (display value)**
- **Measured value INP1**

Each of the 2 pre-alarms $L_{1, m.2} \dots L_{1, m.3}$ has 2 trigger points $H.x$ (Max) and $L.x$ (Min), which can be switched off individually (parameter = "OFF"). The switching difference $HYS.x$ of each limit value is adjustable.

Measured value monitoring

For measured value monitoring, the following rules are applicable:

Mode of action with absolute alarm (Ex. Lim.1)

$L.1 = OFF$

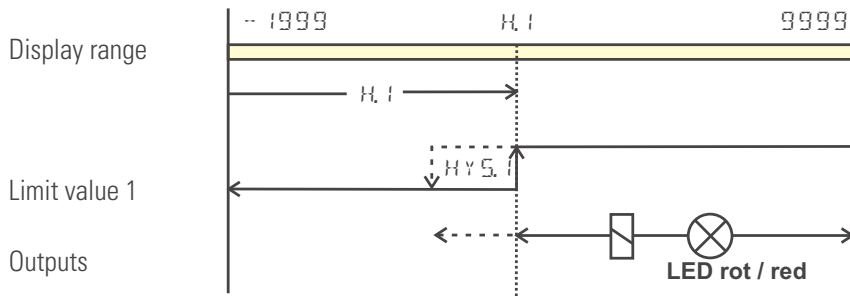

$H.1 = OFF$

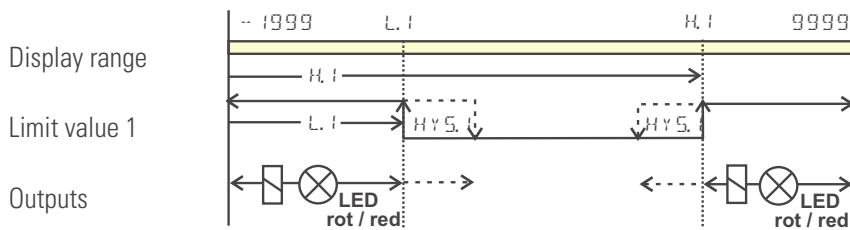
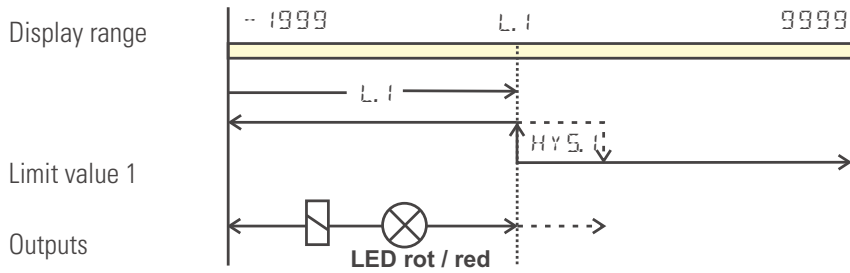

Normally open: ($CONF / OUT.x / OACT = 0$) (as shown in the example)



Normally closed: ($CONF / OUT.x / OACT = 1$) (inverted output relay action)

6.5.1 Monitoring the number of operating hours and switching cycles

Operating hours

The number of operating hours can be monitored. When reaching or exceeding the adjusted value, signal InF.1 is activated (in the error list and via an output, if configured).



The monitoring timer starts when setting limit value C.Std. Reset of signal InF.1 in the error list will start a new monitoring timer. Monitoring can be stopped by switching off limit value C.Std.

-  Adjusting the limit value for operating hours C.Std can be done only via BlueControl®. The current counter state can be displayed in the BlueControl® expert version.
-  The number of operating hours is saved once per hour. Intermediate values are lost when switching off.

Number of switching cycles

The output number of switching cycles can be monitored. When reaching or exceeding the adjusted limit value, signal InF.2 is activated (in the error list and via an output, if configured).

The monitoring timer starts when setting limit value C.Sch. Reset of signal InF.2 in the error list will start a new monitoring timer. Monitoring can be stopped by switching off limit value C.Sch.

-  A switching cycle counter is allocated to each output. Limit value C.Sch acts on all switching cycle counters.
-  Adjusting the limit value for the number of switching cycles C.Sch can be done only via BlueControl®. The current counter state can be displayed in the BlueControl® expert version.

The number of switching cycles is saved once per hour. When switching off, intermediate values are lost.

6.6 Analog output configuration

6.6.1 Analog output (optional)

An analog output is available as a display output.

The two output signals (current and voltage) are available simultaneously. Adjust `CONF / Out.3 / Out.YP` to select the output type which should be calibrated.

<code>CONF / Out.3:</code>	<code>Out.YP</code>	<code>= 1</code>	<code>Out.3</code>	0...20mA continuous
		<code>= 2</code>	<code>Out.3</code>	4...20mA continuous
		<code>= 3</code>	<code>Out.3</code>	0...10V continuous
		<code>= 4</code>	<code>Out.3</code>	2...10V continuous

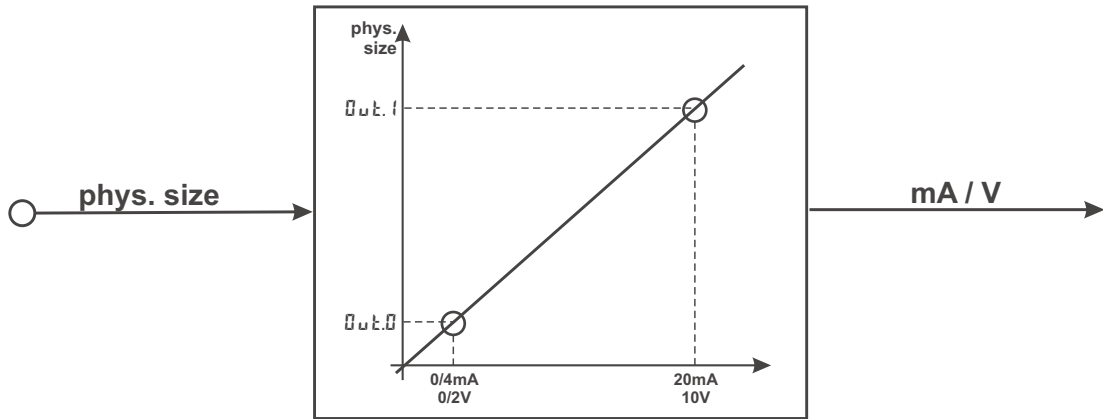

Parameter `Out.src` defines the signal source of the output value.

Example:

<code>Out.src = 3</code>	signal source for <code>Out.3</code> is the process value
--------------------------	---

Scaling of the output range is done via parameters `Out.0` and `Out.1`. The values are specified in units of the physical quantity.

<code>Out.0 = -1999...9999</code>	scaling <code>Out.3</code> for 0/4mA or 0/2V
<code>Out.1 = -1999...9999</code>	scaling <code>Out.3</code> for 20mA or 10V

Example: output of the full input range of thermocouple type J (-100 ... 1200 °C)

<code>Out.0 = -100</code>
<code>Out.1 = 1200</code>

Example: output of a limited input range, e.g. 60.5 ... 63.7 °C)

<code>Out.0 = 60.5</code>
<code>Out.1 = 63.7</code>



Please, note: the smaller the span, the higher the effect of input variations and resolution.



Using current and voltage output in parallel is possible only in galvanically isolated circuits.



Configuration `Out.YP = 2` (4 ... 20mA) or `4` (2...10V) means only allocation of the reference value (4 mA or 2V) for scaling of output configuration `Out.0`. Therefore, output of smaller values is also possible rather than output limiting by reference value 4mA / 2V.



Configuration `Out.tYP = 0/1` (0/4...20mA) or `2/3` (0/2...10V) determines, which output should be used as a calibrated reference output.

6.6.2 Logic output (optional)

Analog output OUT3 can be used also as a logic output ($\text{OUT} \ \gamma \ P = 0$). This output can be used e.g. for pre-alarms.

6.6.3 Transmitter supply (optional)

With setting $\text{OUT} \ \gamma \ P = 5$, two-wire transmitter supply is possible via output OUT3.

In this case, the analog output of the unit is not available.

Connection example:

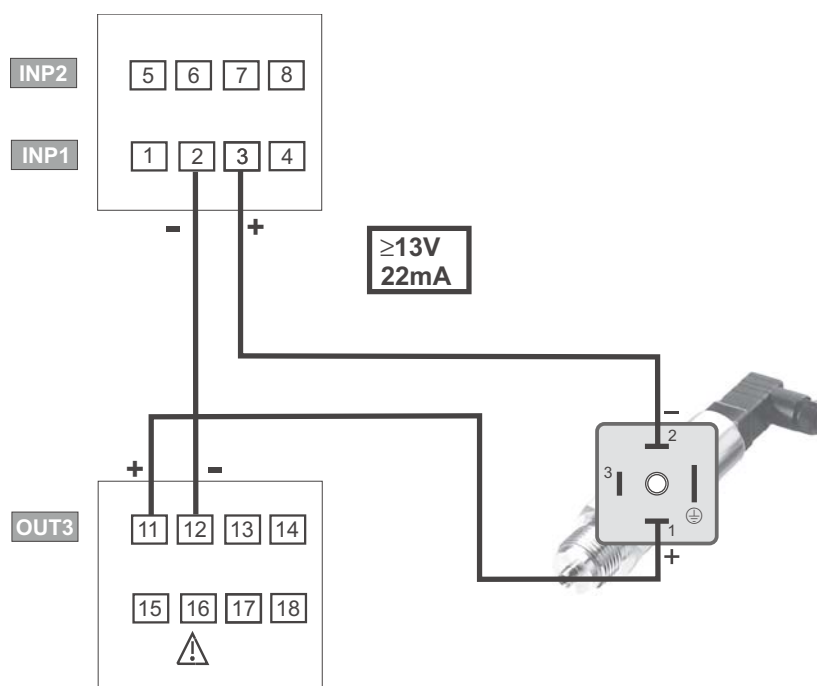

6.7 Maintenance manager / error list

In case of one or several errors, the error list is always displayed at the beginning of the extended operating level .

A current input in the error list (alarm or error) is always indicated by display of letter E .

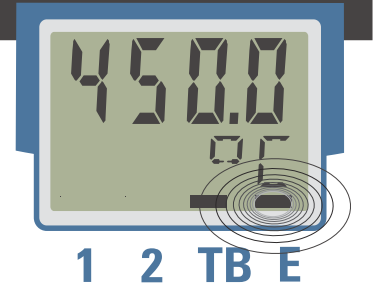

For display of the error list, press key \leftarrow once.

E- display element	Description	Possible remedial action
blinks	Alarm due to existing error	- Determine the error type in the error list via the error number - remove error
on	Error removed, Alarm not acknowledged	- acknowledge alarm in the error list by pressing the \blacktriangle - or the \blacktriangledown -key - the alarm entry is deleted by doing so
off	no error, all alarm entries deleted	

6.7.1 Error list::

Name	Description	Cause	Possible remedial action
E.1	Internal error, cannot be corrected	E.g. defective EEPROM	Contact PMA service Return device to manufacturer
E.2	Internal error, resettable	E.g. EMC trouble	Keep measuring and supply cables separate. Protect contactors by means of RC snubber circuits
E.3	Configuration error, resettable	Missing or faulty configuration	Check interdependencies for configurations and parameters
E.4	Hardware error	Code number and hardware not identical	Contact PMA service Replace electronics/options card
FbF.1	INP1 sensor break	Defective sensor Wiring error	Replace INP1 sensor Check INP1 connection
ShL.1	INP1 short circuit	Defective sensor Wiring error	Replace INP1 sensor Check INP1 connection
POL.1	INP1 polarity error	Wiring error	Change INP1 polarity
Lim.1	Latched limit value alarm 1	Adjusted limit value 1 exceeded	Check process
Lim.2	Latched limit value alarm 2	Adjusted limit value 2 exceeded	Check process
Lim.3	Latched limit value alarm 3	Adjusted limit value 3 exceeded	Check process
InF.1	Time limit value message	Preset number of operating hours reached	Application-specific
InF.2	Switching cycle message (digital outputs)	Preset number of switching cycles reached	Application-specific



Latched alarms Lim2/3 (E element provided) can be acknowledged and reset via digital input di1 or via the reset key function. The reset key function can be disabled using a password.

For Configuration, see *CONF / LOG1 / Error*

Error-state	Signification	
2	Pending error	Change to error status 1 after error removal
1	Stored error	Change to error status 0 after acknowledgement in error list 0
0	no error/message	Not visible, except during acknowledgement



When an alarm is still pending, i.e. unless the error cause was removed (E display blinks), latched alarms cannot be acknowledged and reset.

6.8

Reset to default

In case of faulty configuration, the device can be reset to the default manufacturers condition.

- ① For this, the operator must keep the keys increment and decrement pressed during power-on.
- ② Then, press key increment to select **YES**.
- ③ Press enter to call up the password menu and to enter the valid password. If the password is faulty, reset is not possible.
- ④ Confirm factory resetting with Enter and the copy procedure is started (display **COPY**).
- ⑤ Afterwards the device restarts.

In all other cases, no reset will occur (timeout abortion).

- ①   + Power on



- ② 



- ③ 



- ④  



- ⑤



If one of the operating levels was blocked in BlueControl[®], reset to factory setting is not possible.



The copy procedure (**COPY**) can take some seconds.

Now, the transmitter is in normal operation.

7 Configuration level

7.1 Configuration survey

Display suppression of configuration data dependent on instrument version and other configuration settings is possible. The data operable via the instrument front panel are shown below.

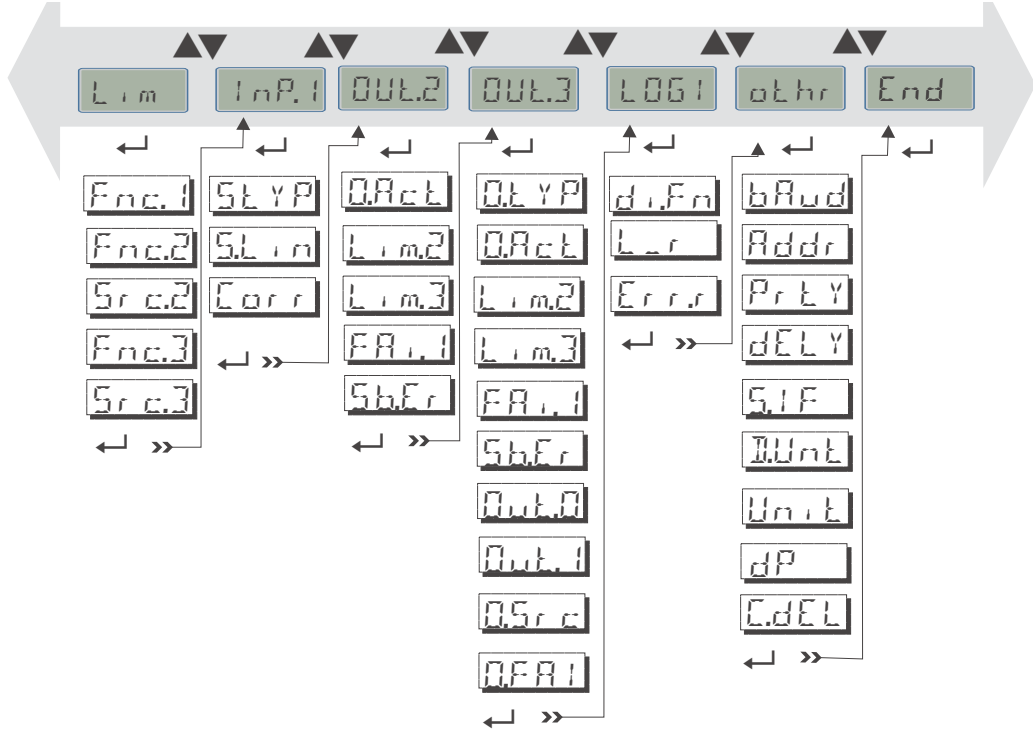

Setting:

- The configurations can be adjusted by means of keys **▲▼**.
- Transition to the next configuration element is by pressing key **←**.
- After the last configuration of a group, **donE** is displayed and an automatic change to the next group is made.



Return to the start of a group is by pressing key **←** during 3 sec.



With configuration changes, please, check all dependent parameters for validity.

7.2

Configuration

Dependent on instrument version and configuration settings, display of values which are not required is suppressed.

☛ The entries marked with this symbol are selectable only, if the instrument option is fitted.

Inputs InP.1

Name	Value range	Description
S.L. Y P		Sensor type
	0	Thermocouple type L (-100...900°C), Fe-CuNi DIN
	1	Thermocouple type J (-100...1200°C), Fe-CuNi
	2	Thermocouple type K (-100...1350°C), NiCr-Ni
	3	Thermocouple type N (-100...1300°C), Nicrosil-Nisil
	4	Thermocouple type S (0...1760°C), PtRh-Pt10%
	5	Thermocouple type R (0...1760°C), PtRh-Pt13%
	6	Thermocouple type T (-200...400°C), Cu-CuNi
	7	Thermocouple type C (0...2315°C), W5%Re-W26%Re
	8	Thermocouple type D (0...2315°C), W3%Re-W25%Re
	9	Thermocouple type E (-100...1000°C), NiCr-CuNi
	10	Thermocouple type B (0/100...1820°C), PtRh-Pt6%
	18	Special thermocouple (linearization necessary)
	20	Pt100 (-200.0 ... 100.0 °C) (150°C with reduced lead resistance)
	21	Pt100 (-200.0 ... 850.0 °C)
	22	Pt1000 (-200.0...850.0 °C)
	23	Special 0...4500 Ohm (preset KTY11-6)
	24	Special 0...450 Ohm
	25	Special 0...1600 Ohm
	26	Special 0...160 Ohm
	30	0...20mA / 4...20 mA
	40	0...10V / 2...10 V (Inp.1 only)
	41	Special (-2,5...115 mV)
	42	Special (-25...1150 mV)
	43	Special (-25...90 mV)
	44	Special (-500...500 mV)
	45	Special (-5...5 V) (Inp.1 only)
	46	Special (-10...10 V) (Inp.1 only)
47	Special (-200...200 mV)	
50	Potentiometer 0...160 Ohm	
51	Potentiometer 0...450 Ohm	
52	Potentiometer 0...1600 Ohm	
53	Potentiometer 0...4500 Ohm	
S.L. n		Linearization only adjustable with S.L. Y P :18, 23 ... 47
	0	none
	1	Special linearization. Producing a linearization table is possible via BlueControl (Engineering-Tool). Preset is the characteristic for KTY 11-6 temperature sensors.

Name	Value range	Description
Corr		Measured value correction / scaling: When using current, voltage orr (version-dependent) resistance signals as input variables, scaling at parameter level is possible. Specify the input value of the lower and upper scaling point in units of the relevant electrical quantity (mA / V/ Ohm).
	0	No correction
	1	The offset correction (at CAL level) is possible on-line at the process. If InL shows the lower input value of the scaling point, OuL must be set to the relevant display value. Adjustment is via the instrument front panel.
	2	2-point correction (at CAL level) is possible off-line by means of a process value transmitter. Specify the process value for the lower and the upper scaling point and confirm it as input value InL or InH. Now, adjust the relevant display value OuL or OuH. Adjustment is via instrument front panel operation.
3	Scaling (at PArA level) for current and voltage signals as input variables also for resistance signals dependent on version). The input and display value values for lower (InL, OuL) and upper scaling point (InH, OuH) are visible at parameter setting level. Adjustment is via instrument front panel operation, or via the engineering tool.	

Limit values LC, Lim2, Lim3

Name	Value range	Description
Fnc.1		Function of main alarm LC
	0	switched off
	1	Measured value monitoring. When exceeding the limit value, an alarm is output and reset automatically, when the measured value is "within the limits" (including hysteresis) again.
	2	Measured value monitoring + alarm status latch. A stored limit value can be reset by pressing the RESET key or via the digital input (→ LOGI/Err.r).
	5	Temperature monitor function for exceeded high limit value. As opposed to the temperature limiter function, the limit value is not stored.
	6	Temperature monitor function for exceeded low limit value. As opposed to the temperature limiter function, the limit value is not stored.
	7	Temperature limiter for high limit value: measured value monitoring + high limit value alarm status latch. A stored limit value can be reset via a digital input or by pressing the RESET key (-> LOGI/Err.r).
	8	Temperature limiter for low limit value: measured value monitoring + low limit value alarm status latch. A stored limit value can be reset via a digital input or by pressing the RESET key (-> LOGI/Err.r).
Fnc.2 (Fnc.3)		Function of pre-alarm 2 / 3
	0	switched off
	1	Measured value monitoring If a limit is exceeded an alarm signal is executed. It becomes resetted automatically, when the measured value has returned to the "acceptable" range (including hysteresis).
2	Measured value monitoring + alarm status latch. A stored limit value can be reset via error list or a digital input (→ LOGI/Err.r).	
Src.2 (Src.3)		Source for pre-alarms 2 / 3
	0	Process value = absolute alarm
	1	Process value - limit value LC = relative alarm
3	Measured value of the analog input INP1	
C.Std	OFF; 1 ... 9999999	Monitoring operating hour (only visible with BlueControl!)
C.Sch	OFF; 1 ... 9999999	Monitoring duty cycle (only visible with BlueControl!)

Output Out.2, Out.3 ⚙

Name	Value range	Description
OULYP		Type of OUT (only Out.3 - analog) ⚙
	0	Relay/logic
	1	0...20 mA continuous
	2	4 ... 20 mA continuous
	3	0...10 V continuous
	4	2...10 V continuous
	5	Transmitter supply
OACT		Direction of operation
	0	Direct / normally open
	1	Inverse / normally close
Lim2		Signal limit 2
	0	Not active
	1	Active
Lim3		Signal limit 3
	0	Not active
	1	Active
FAI.1		Signal INP1 fail
	0	Not active
	1	Active
SbEr		System bus error message: internal system bus communication error. The output is set in case of an error in the internal system bus communication, no communication with this instrument occurs
	0	Not active
	1	Active
Inf.1		Message Inf.1 status. The Inf.1 signal is generated, when the limit value for the operating hours is reached.
	0	not active
	1	active
Inf.2		Message Inf.2 status. The Inf.2 signal is generated, when the limit value for the number of switching cycles is reached.
	0	not active
	1	active
OUL0	-1999...9999	Scaling 0% (only for Out.3 analog) ⚙ Lower analog output scaling limit (corresponds to 0%). When using current or voltage signals as output variables, the display values can be scaled to the output values at parameter level. Specification of the output value of the lower scaling point is in units of the relevant electrical quantity (mA / V).
	-1999...9999	Scaling 100% (only for Out.3 analog) ⚙ Upper analog output scaling limit (corresponds to 100%). When using current or voltage signals as output variables, the display can be scaled to the output values at parameter level. Specification of the output value of the upper scaling point is in units of the relevant electrical quantity (mA / V).
OUL1		Signal source (only for Out.3 analog) ⚙
	0	Not active
	3	Process value
OSrc	7	INP1
		Fail behaviour ⚙
OFAI	0	upscale
	1	downscale

Signal allocation LOGI

Name	Value range	Description
diFn		Function of inputs
	0	Direct
	1	Inverse
	2	Toggle key function (adjustable for 2-point operation with interface and di1)
L_r		Local / Remote switch-over (Remote: Adjustment of values via front is blocked)
	0	no function (switching via interface is possible)
	1	always on
	2	di1 switches
	7	limit 1 switches
	8	limit 2 switches
Err_r		Source of control signal for resetting all stored error list entries. All error messages and alarms are in the error list. If an alarm is still pending, i.e. unless the error cause was removed, stored alarms cannot be acknowledged, i.e. reset. Resetting of all stored error list entries.
	2	di1 switches
	6	Reset keys switch

Miscellaneous othr

Name	Value range	Description
bAud		Baudrate of interface ⚙
	0	2400 Baud
	1	4800 Baud
	2	9600 Baud
	3	19200 Baud
4	38400 Baud	
Addr	1...247	Address ⚙
PrLY		Parity ⚙
	0	No parity, 2 stop bits
	1	Even parity
	2	Odd parity
3	No parity, 1 stop bit	
dELY	0...200	Response delay [ms] ⚙
SIF		Enable system interface μ
	0	The system interface is de-activated.
	1	The system interface is activated (field bus communication via bus coupler).

Name	Value range	Description
Unit		display unit
	0	no unit
	1	temperature unit
	3	%
	4	bar
	5	mbar
	6	Pa
	7	kPa
	8	psi
	9	l
	10	l/s
	11	l/min
	12	Ohm
	13	kOhm
	14	m
	15	A
	16	mA
	17	V
	18	mV
	19	kg
	20	g
	21	t
	22	Text of physical unit (definable in T.Unit/controllable via BlueControl [®])
Unit		Temperature-unit
	0	no unit
	1	°C
	2	°F
dP		decimal points
	0	no decimalpoint (0 digits behind the decimal point)
	1	1 digit behind the decimal point
	2	2 digits behind the decimal point
C.dE1		3 digits behind the decimal point
	0..200	Modem delay [ms]
FrEq		Switch over 50/60 Hz (only visible with BlueControl [®] !)
	0	Netfrequency 50 Hz
IExo	1	Netfrequency 60 Hz
		Block extended operating level (only visible with BlueControl [®] !)
IRES	0	Released
	1	Blocked
IRES		LC alarm reset via the keys can be protected additionally by means of a password.
	0	Enabled
Pass	1	Disabled
	OFF...9999	Password (only visible with BlueControl [®] !)
IPar		Block parameter level (only visible with BlueControl [®] !)
	0	Released
ICnf	1	Blocked via passnumber
		Blockierung Konfigurationsebene (nur mit BlueControl sichtbar!)
ICal	0	Released
	1	Blocked
ICal		Block calibration level (only visible with BlueControl [®] !)
	0	Released
ICal	1	Blocked

Name	Value range	Description
Dis1		Selection which value should be displayed on display line 1
	0	Display value
	1	Limit value LC
T.Dis2		Settings for text in display 2 (max. 5 digits) (only visible with BlueControl® !)

Linearization Lin

Only visible via BlueControl® !

Name	Value range	Description
U.LinT		Temperature unit of the linearization table
	0	without unit
	1	in Celsius
	2	in Fahrenheit
	3	in Kelvin
In.1 ... In.16	OFF (ab In.3) -1999...9999	Input 1 ... input 16
Ou.1 ... Ou.16	-999.0 ... 9999	Output 1 ... output 16



Value U.LinT defines the unit of input values specified for linearization of temperature values. Value entry in Celsius despite display of the measured value in Fahrenheit is possible.

- Specify the input signals mV, V, mA, % or Ohm dependent on input type.
- For special thermocouples (S.tYP = 18), specify the input values in μV and the output values in the temperature unit adjusted in U.LinT.
- For special resistance thermometer (KTY 11-6) (S.tYP = 23), specify the input values in Ohm and the output value in the temperature unit adjusted in U.LinT.



Resetting to factory setting (default)

→ chapter 2.4, 6.8 (page 8)

8

Parameter level

8.1

Parameter survey

Dependent on device version und adjusted configurations values not needed become hidden.

8.2

Adjustment

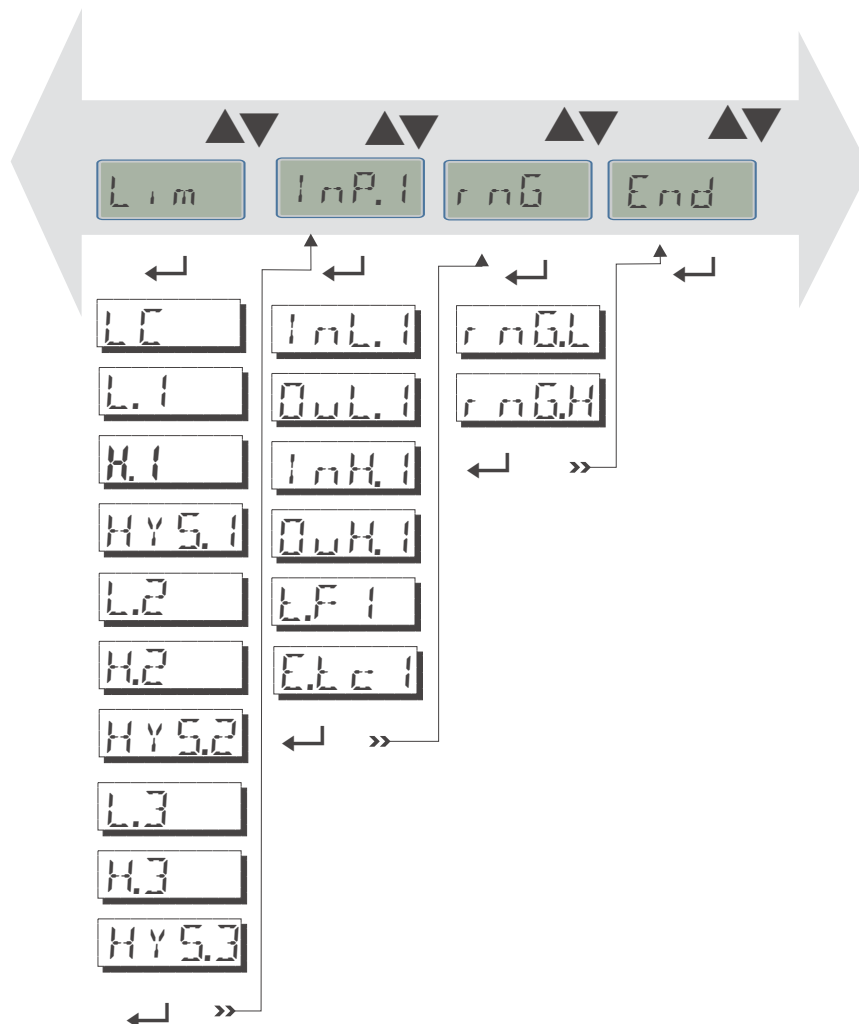

- Parameters can be adjusted with \uparrow/\downarrow - keys.
- Stepping to the next parameter by pressing the \leftarrow - key.
- After the last parameter of a group *donE* appears in the display and the unit steps automatically to the next group.



Stepping back to the beginning of a group is done by pressing the \leftarrow - key for 3 s.

If, for 30 s no key is pressed, the unit returns to the operating level (Timeout = 30 s).

9 Calibrating level

In the calibration menu (CAL) the measured value can be adjusted.



Please, note that the input value may be shifted when handling the calibration function. Therefore, check the effects on the adjusted limit value.



The measured value correction (CAL) is accessible only, if $Corr = 1$ or 2 was selected.

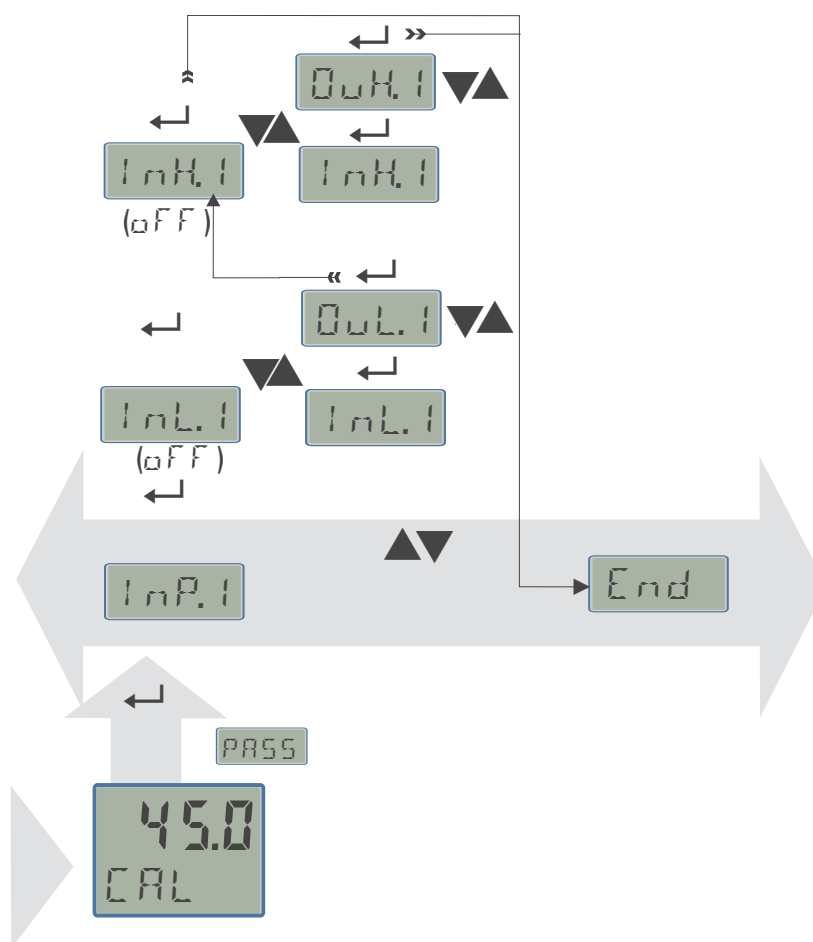

Two methods are available

- **Offset - correction**
- **2-point - correction**



The InL_x and InH_x values are presented with one digit. As reference for the correcting calculation the full resolution is used.



Deleting the correction values is done fastest by switching off the measured value correction $Corr = 0$ or setting the scaling parameters to a linear behaviour.



The values InL_x and InH_x show the real measured value. The output values $OutL_x$ and $OutH_x$ start with the preset value.

9.1 Offset correction

The offset-correction shifts the input value by a pre-defined value.
 Parameter setting: (CONF/InP/Corr = 1)

- On-line offset correction at the process is possible.

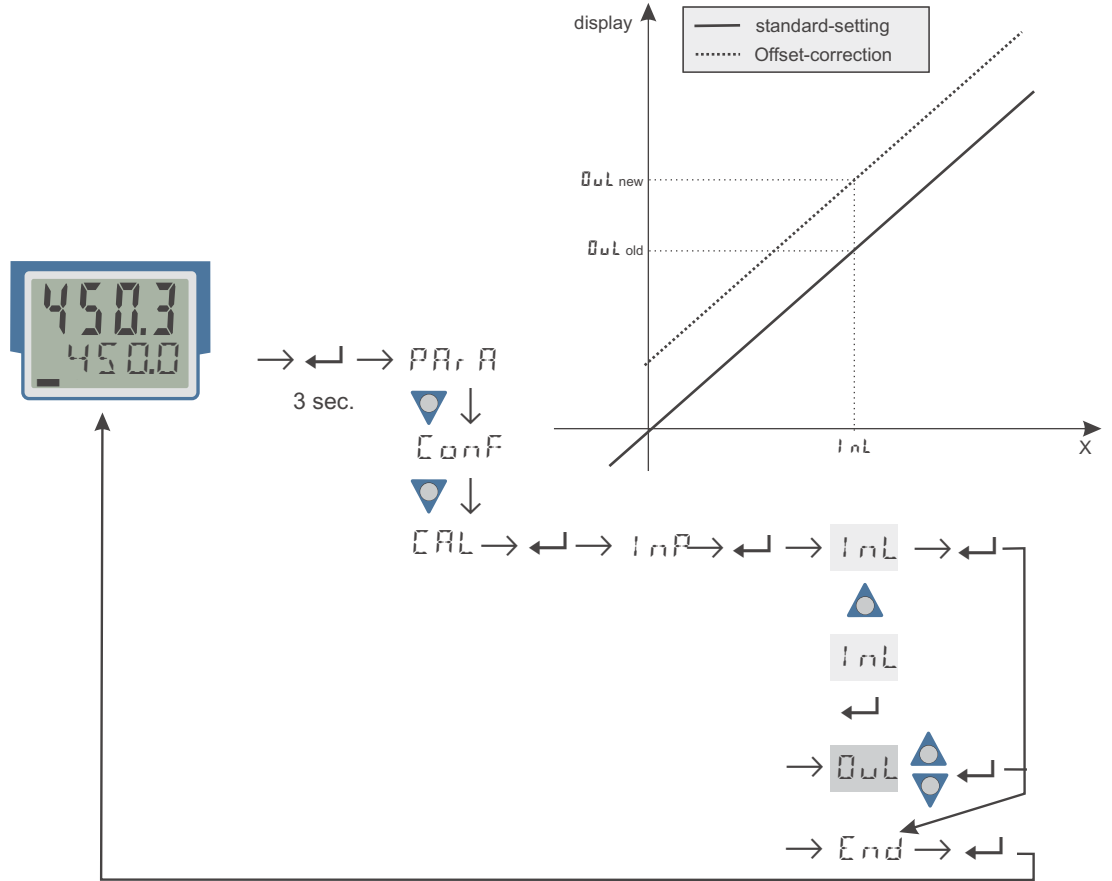

- InL :** The actual input value of the scaling point is displayed.
 The correction function is activated by means of keys $\uparrow\downarrow$; the display changes from Off to the measured value.
 The operator must wait, until the process is at rest.
 Subsequently, the input value has to be confirmed by pressing key \leftarrow .
- OutL :** The scaling point display value is indicated.
 The operator can correct the display value by pressing keys $\uparrow\downarrow$.
 Subsequently, he presses key \leftarrow to confirm the display value.

9.2 2-point correction

2-point correction can change the offset and gradient of the input curve.

Parameter setting:
($CONF/InP/Corr = 2$):

- 2-point correction is possible off-line by means of an input signal simulator,
- or on-line in 2 steps: correct one value first and the second value subsequently, e.g. after heating up the furnace..

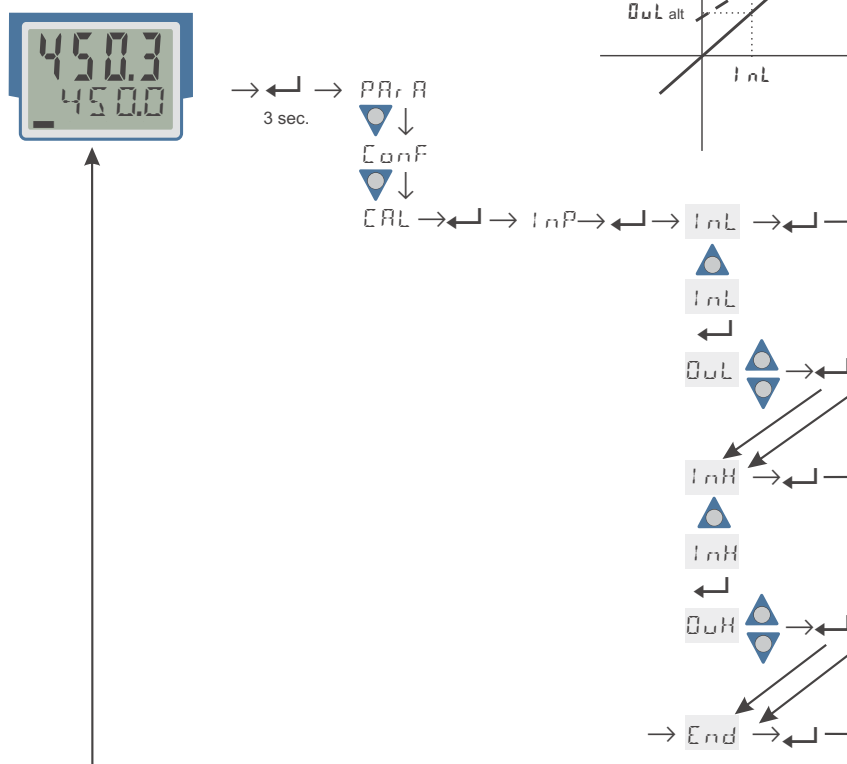
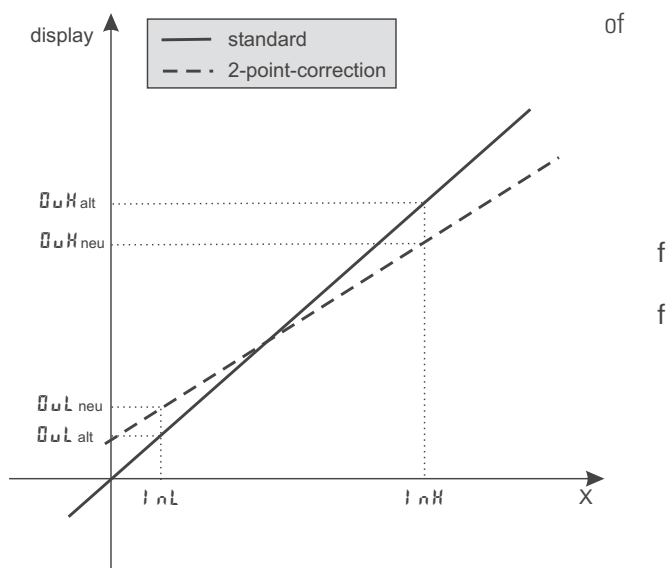

- InL:** The input value of the lower scaling point is displayed. The correction function is activated via keys $\blacktriangle/\blacktriangledown$; the display changes from Off to the measurement value. Adjust the lower input value by means of an input signal simulator and press key \leftarrow to confirm the input value.
- OutL:** The display value of the lower scaling point is indicated. Press keys $\blacktriangle/\blacktriangledown$ to correct the lower display value and press key \leftarrow to confirm the display value.
- InH:** The input value of the second scaling point is displayed. Activate the corrective function by pressing keys $\blacktriangle/\blacktriangledown$; the display changes from Off to the measured value. Adjust the upper input value by means of the input signal simulator and confirm the input value by pressing key \leftarrow .
- OutH:** The display value of the upper scaling point is indicated. Correct the upper display value by pressing keys $\blacktriangle/\blacktriangledown$ and press key \leftarrow to confirm the display value.

10 BlueControl engineering tool

The Engineering Tool BlueControl® is the projecting environment for the BluePort® controller series as for the **rail line** family of PMA. The following 3 versions with graded functionality are available:

Functionality	Mini	Basic	Expert
parameter and configuration setting	yes	yes	yes
download: transfer of an engineering to the unit	yes	yes	yes
online mode / visualization	SIM only	yes	yes
defining an application specific linearization	SIM only	yes	yes
configuration in the extended operating level	yes	yes	yes
Upload: reading an engineering from the unit	SIM only	yes	yes
basic diagnostic functions	no	no	yes
saving data file and engineering	no	yes	yes
printer function	no	yes	yes
online documentation, help	yes	yes	yes
implementation of measurement value correction	yes	yes	yes
data acquisition and trend display	SIM only	yes	yes
wizard function	yes	yes	yes
extended simulation	no	no	yes

The mini version is - free of charge - at your disposal as download at PMA homepage www.pma-online.de or on the PMA-CD (please ask for).

At the end of the installation the licence number has to be stated or DEMO mode must be chosen.

At DEMO mode the licence number can be stated subsequently under *Help* → *Licence* → *Change*.

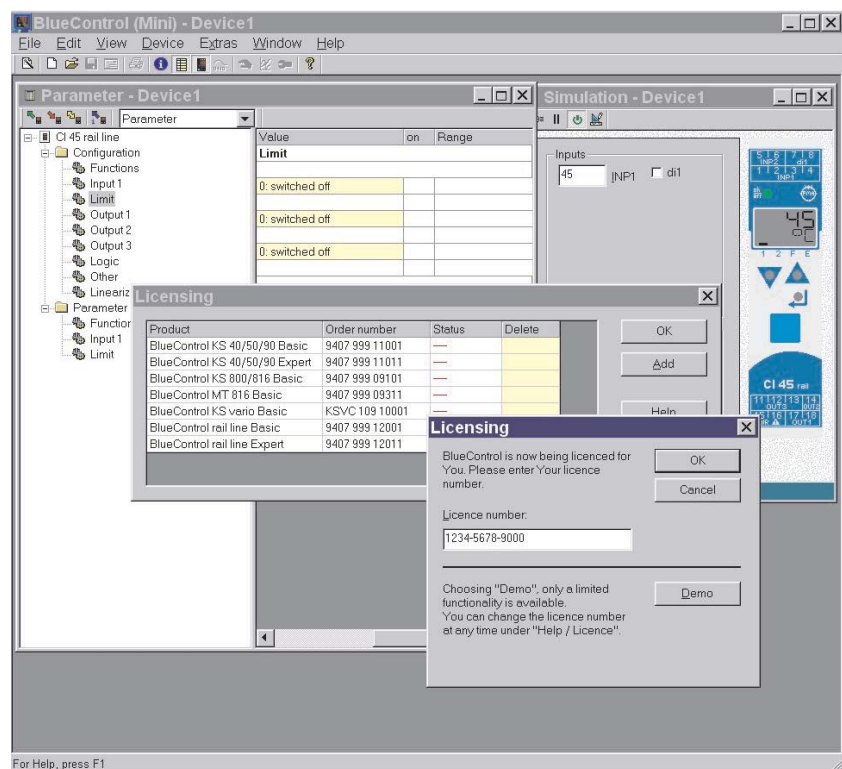

11 Versions

Temperature limiter TB 45



1 universal input 1 digital input with display and BluePort® interface

without plug-in connector terminals	0				
with screw terminal connector	1				
90...250V AC, 2 relays	0				
18...30VAC/18...31VDC, 2 relays	1				
90...250V AC, mA/V/logic + 2 relays	2				
18...30VAC/18...31VDC, mA/V/logic +2 relays	3				
without options	0				
RS 485 / MODBUS - protocol	1				
System interface (only for 24 V version)	2				
di1 as contact input		0			
di1 as optocoupler input		1			
Standard configuration			0		
Customer-specific configuration			9		

DIN 3440 / EN 14597

D

Accessories delivered with the unit:

- **Operating note**
- **Rail-to-bus connector for the interface option**

Additional equipment with ordering data.

Documentations (please order the relevant documentation)

operation manual TB 45	german	9499-040-71918
operation manual TB 45	english	9499-040-71911
interface description MODBUS rail line	german	9499-040-72018
interface description MODBUS rail line	english	9499-040-72011

Additional equipment

Description		Order-No.
PC-adapter for BluePort® interface		9407-998-00001
BlueControl® Mini	german/english	www.pma-online.de
BlueControl® with basic - licence rail line	german/english	9407-999-12001
BlueControl® with expert - licence rail line	german/english	9407-999-12011

12 Technical data

INPUTS

UNIVERSAL INPUT INP1

Type: single-ended, except thermocouples

Resolution: > 14 bits
 Decimal point: 0 to 3 decimals
 Digital input filter: adjustable 0,0...999,9 s
 Scanning cycle: 100 ms
 Linearization: 15 segments, adaptable with BlueControl[®]
 Measurement value correction: 2-point or offset
 Limiting frequency: 1,7 Hz

Thermocouples (Table 1)

Input resistance: $\geq 1\text{ M}\Omega$
 Influence of source resistance: $1\text{ }\mu\text{V}/\Omega$
 Input circuit monitor break, reversed polarity

Cold-junction compensation

- internal,
 - additional error: typ.: $\leq \pm 0,5\text{ K}$
max.: $\leq -2,5\text{ K}$

external,
 -constant reference 0...100 °C

Break monitoring

Sensor current: $\leq 1\text{ }\mu\text{A}$
 Operating sense configurable

Resistive sensors (Table 2)

Connection technique: 3-Leiter,
 Lead resistance (for max. span): max. $30\text{ }\Omega$
 Input circuit monitoring: break and short circuit

Measurement span

The BlueControl[®] software enables the internal characteristic curve for the KTY 11-6 temperature sensor to be adapted.

Divided into ranges 0...4500 Ω
 Physical measurement range:

Current and voltage measurement (Table 3)

Span start and span: anywhere within the measurement range
 Scaling: freely selectable -1999...9999
 Input circuit monitoring (current): 12,5% below span start (2 mA)

Table 1: Thermocouple input

Thermocouple type		Measurement range		Accuracy	Typical resol.
L	Fe-CuNi (DIN)	-100...900°C	-148...1652°F	$\leq 2\text{K}$	0,1 K
J	Fe-CuNi	-100...1200°C	-148...2192°F	$\leq 2\text{K}$	0,1 K
K	NiCr-Ni	-100...1350°C	-148...2462°F	$\leq 2\text{K}$	0,2 K
N	Nicrosil/Nisil	-100...1300°C	-148...2372°F	$\leq 2\text{K}$	0,2 K
S	PtRh-Pt 10%	0...1760°C	32...3200°F	$\leq 2\text{K}$	0,2 K
R	PtRh-Pt 13%	0...1760°C	32...3200°F	$\leq 2\text{K}$	0,2 K
T**	Cu-CuNi	-200...400°C	-328...752°F	$\leq 2\text{K}$	0,05 K
C	W5%Re-W26%Re	0...2315°C	32...4199°F	$\leq 3\text{K}$	0,4 K
D	W3%Re-W25%Re	0...2315°C	32...4199°F	$\leq 3\text{K}$	0,4 K
E	NiCr-CuNi	-100...1000°C	-148...1832°F	$\leq 2\text{K}$	0,1 K
B*	PtRh-Pt6%	0(400)...1820°C	32(752)...3308°F	$\leq 3\text{K}$	0,4 K
Special		-25 ... +75 mV		$\leq 0,1\%$	0,01%

* Values apply from 400 °C upwards

** Values apply from -80 °C

Table 2: Resistive inputs

Type	Sensor current	Measuring range		Accuracy	Resolution (∅)
Pt100***	≤ 0,25 mA	-200...100 (150) °C	-328...212°F	≤ 1 K	0,1 K
Pt100		-200...850°C	-328...1562°F	≤ 1 K	0,1 K
Pt1000		-200...850°C	-328...1562°F	≤ 2 K	0,1 K
KTY 11-6*		-50...150°C	-58...302°F	≤ 2 K	0,1 K
Special		0...4500 Ω**		≤ 0,1 %	0,01 %
Special		0...450 Ω**		≤ 0,1 %	0,01 %
Poti		0...160 Ω**		≤ 0,1 %	0,01 %
Poti	0...450 Ω**		≤ 0,1 %	0,01 %	
Poti	0...1600 Ω**		≤ 0,1 %	0,01 %	
Poti	0...4500 Ω**		≤ 0,1 %	0,01 %	

* Default setting is the characteristic for KTY 11-6 (-50...150°C)

** Including lead resistance

*** Up to 150°C with reduced lead resistance (max. 160 Ω total)

Table 3: Current and voltage input

Measurement range	Input resistance	Accuracy	Typical resolution
0...20 mA	20 Ω	≤ 0,1 %	1,5 μA
0...10 V	≈ 110 kΩ	≤ 0,1 %	0,6 mV
-10...10 V	≈ 110 kΩ	≤ 0,1 %	1,2 mV
-5...5 V	≈ 110 kΩ	≤ 0,1 %	0,6 mV
-2,5...115 mV*	> 1 MΩ	≤ 0,1 %	6,0 μV
-25...1150 mV*	> 1 MΩ	≤ 0,1 %	60,0 μV
-25...90 mV*	> 1 MΩ	≤ 0,1 %	8,0 μV
-500...500 mV*	> 1 MΩ	≤ 0,1 %	80,0 μV
-200...200 mV*	> 1 MΩ	≤ 0,1 %	40,0 mV

* For INP1: high-impedance, without break monitoring

CONTROL INPUT DI1 (RESET)

Configurable as direct or inverse switch or **push button!**

Contact input

Connection of potential-free contact that is suitable for switching 'dry' circuits.

Switched voltage: 5 V
Switched current: 1 mA

Optocoupler input

Actively switched optocoupler input

Nominal voltage: 24 V DC external
Logic "0": -3 V...+5 V
Logic "1": 15 V...30 V
Current demand: max. 6 mA

OUTPUTS

RELAY OUTPUTS LC, OUT2

Type: 2 NO contacts with a common terminal
Max. contact rating: 500 VA, 250 VAC, 2A at 48...62 Hz, resistive load
Min. contact rating: 6V, 1 mA DC
Switching cycles (electrical): for I=1A/2A: ≥ 800.000/500.000 (at 250VAC, resistive load)

Note:

If the relays LC and OUT2 operate external contactors, these must be fitted with RC snubber circuits to manufacturer specifications to prevent excessive voltage peaks at switch-off.

OUT3 AS UNIVERSAL OUTPUT (OPTION)

Galvanically isolated from the inputs. Parallel current/voltage output with common 'minus' terminal (combined use only in galvanically isolated circuits).

Freely scalable

Resolution: 14 bits
Dynamic response (step change of input signal) T_r: Output follows the input: ≤ 540 ms
Tracking error I/U: ≤ 2 %
Residual ripple (referred to end of span): ≤ ±1%
0...130 kHz

Current output

0/4...20 mA, configurable
short-circuit proof
Control range: -0,5...23 mA
Load: ≤ 700 Ω

Technical data

Load effect:	≤ 0,02%
Resolution:	≤ 1,5 μA
Error:	≤ 0,1%

Voltage output

0/2...10V, configurable not continuously short-circuit proof	
Control range:	-0,15...11,5 V
Load:	≥ 2 kΩ
Load effect:	≤ 0,06%
Resolution:	≤ 0,75 mV
Error:	≤ 0,1%
Additional error with simultaneous use of current output	≤ 0,09%

OUT3 as transmitter supply

Output:	22 mA / ≥ 13 V
---------	----------------

OUT3 as logic signal

Load ≤ 700 Ω	0/≤ 23 mA
Load > 500 Ω	0/> 13 V

GALVANIC ISOLATION (FIG. 1)

Permissible voltages:

Fig. 1: galvanic isolation

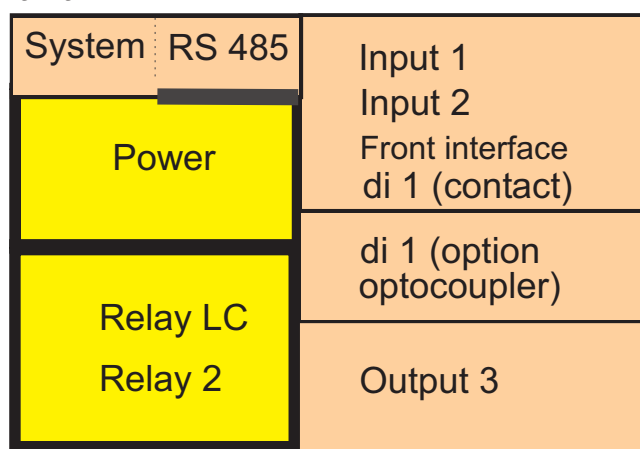

— Safety isolation
— Function isolation

Safety isolation:	≤ 300 Vrms against earth
Functional isolation:	≤ 30 Vrms against earth

POWER SUPPLY

Depending on ordered version:

AC supply

Voltage:	90...250 V AC
Frequency:	48...62 Hz
Power consumption:	approx 9 VA max.

Universal supply 24 V UC

AC voltage:	18...30 V AC
Frequency:	48...62 Hz
DC voltage:	18...31 V DC
Power consumption:	Approx. 3 VA / W max.
Supply only from protective low-voltage sources (SELV)	

Behaviour with power failure

Configuration and parameter settings:
Permanent storage in EEPROM

BLUEPORT FRONT INTERFACE

Connection to the transmitter front via a PC adapter (see 'Accessories'). The BlueControl® software enables the TB 45 to be configured, parameters set, and operated.

BUS INTERFACE (OPTIONAL)

RS 485

Connection via bus connector fitted in the top-hat rail. Screened cables should be used.

Galvanically isolated	
Type:	RS 485
Transmission speed:	2400, 4800, 9600, 19.200, 38.400 bits/s
Parity:	even, uneven, none
Address range:	1...247
Number of devices per bus segment:	32

PROTOCOL

- Modbus RTU

SYSTEM INTERFACE

For connection to field bus coupler (s. System components)
Connection via bus connector in the top-hat rail.

ENVIRONMENTAL CONDITIONS

Protection classes

Front panel:	IP 20
Housing:	IP 20
Terminals:	IP 20

Permissible temperatures

For specified accuracy:	-10...55°C
Warm-up time:	≤ 20 minutes
Temperature effect:	≤ 0,05% / 10 K
Additional effect of CJ compensation:	≤ 0,75 K / 10 K
Operating limits:	-20...60°C
For storage:	-30...70°C

Altitude

To 2000 m above sea leveln

Humidity

Max. 95%, 75% yearly average, no condensation

Shock and vibration

Vibration test Fc (DIN EN 60 068-2-6)

Frequency:	10...150 Hz
Unit in operation:	1g or 0,075 mm
Unit not in operation:	2g or 0,15 mm

Shock test Ea (DIN EN 60 068-2-27)

Shock:	15g
Duration:	11ms

Electromagnetic compatibility

Complies with EN 61 326-1 for continuous, unattended operation.

Interference radiation:

Within the limits for Class B devices.

Immunity to interference:

Meets the test requirements for devices in industrial areas.

Evaluation criteria:

- Surge interference partly has marked effects, which decay after the interference stops.
- With high levels of surge interference on 24 VAC mains leads, it is possible that the device is reset.
- With HF interference, effects up to 50 µV can occur.

GENERAL

Housing front:

Material	Polyamid PA 6.6
Flammability class:	V0 (UL 94)

Connecting terminals:

Material:	Polyamid PA
Flammability class:	V2 (UL 94) for screw terminals V0 (UL 94) for spring-clamp terminals and bus connections

Electrical safety

CE conform

Complies with EN 61 010-1:

Working voltage range 300V, Over-voltage category II,

Contamination degree 2,

Protection class II

Electrical connections

Plug-in connector strips with choice of terminal type:

- Screw terminals for lead cross-sections from 0,2 to 2,5 mm²
- Spring-clamp terminals for lead cross-sections from 0,2 to 2,5 mm²

Mounting method

Clip-on rail mounting (35 mm top-hat rail to EN 50 022).

Locked by means of metal catch in housing base.

Close-packed mounting possible.

Mounting position:	vertical
Weight:	0,18 kg

Standard accessories

- Operating instructions
- With 'Interface' option: bus connector for fitting into top-hat rail

CERTIFICATIONS

- Type tested to EN 14597 (replaces DIN 3440) With certified sensors applicable for:
 - Heat generating plants with outflow temperatures up to 120°C to DIN 4751
 - Hot-water plants with outflow temperatures above 110°C to DIN 4752
 - Thermal transfer plants with organic transfer media to DIN 4754
 - Oil-heated plants to DIN 4755

13 Index

Index	
!	
2-point-correction	43
A	
Accessories	45
Additional equipment	45
Analog output	28 - 29
Applications	5
B	
Behaviour after supply v. on	17
C	
Calibration (CAL)	41
Cleaving	8
Configuration level (CONF)	
- Configuration parameter	33 - 38
Connecting	
- Bus interface	12
- di1	12
- Inp1	11
- Out1, Out2	12
- Out3	12
Connecting diagram	11
Connector	10
D	
Dismounting	9
E	
Extended operating level	19
F	
Filter	25
Front view	16
Functions	21 - 31
H	
Hints for installation	15
I	
Input error detection	24
Input scaling	23 - 24
L	
Limit values	25 - 27
Linearization	38
Logic output	29
M	
Maintenance	8
Maintenance manager	30
Mounting	9 - 10
N	
Number of switching cycles	27
O	
Offset-correction	42
Operating hours	27
Operating structure	17
Operation	16 - 20
P	
Parameter level (PARA)	
- Parameter	40
- Parameter survey	39
S	
Safety hints	7 - 8
Spare parts	8
T	
TAG -no.	20
Technical data	46 - 49
Terminal connections	11 - 12
Transmitter supply	29
Two-wire measurement	24
V	
Versions	45
Z	
Zweileiter - Messung	24



9499-040-71911

Subject to alterations without notice
Änderungen vorbehalten
Sous réserve toutes des modifications

© PMA Prozeß- und Maschinen-Automation GmbH
P.O.B. 310 229, D-34058 Kassel, Germany
Printed in Germany 9499-040-71911 (02/2012)

A4, unibind, SW-Druck, 80g weiß