



Temperature limiter TB 40-1



TB40-1
TB40-1
TB40-1
TB40-1
TB40-1
TB40-1

universal line
universal line

Operating manual
English
9499-040-93411
Valid from: 8505



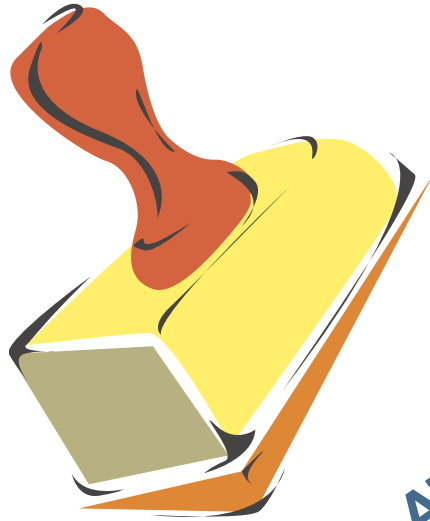

BlueControl

More efficiency in engineering,
more overview in operating:
The projecting environment for the BluePort® controllers



ATTENTION!
Mini Version and Updates on
www.pma-online.de
or on PMA-CD

Description of symbols in the text:

-  General information
-  General warning
-  Attention: ESD-sensitive devices

on the device:

-  Follow the operating instructions

© PMA Prozeß- und Maschinen-Automation GmbH • Printed in Germany
All rights reserved. No part of this document may be reproduced or published in any form or by
any means without prior written permission from the copyright owner.

A publication of PMA Prozeß- und Maschinen Automation
P.O.Box 310229
D-34058 Kassel
Germany

Contents

1	Mounting	4
2	Electrical connections	5
2.1	Connecting diagram TB 40-1 temperature limiter TB	5
2.1.1	Terminal connection	5
2.2	Connecting diagram TB 40-1 temperature monitor TW	7
3	Operation.	8
3.1	Front view.	8
3.2	Behaviour after power-on.	8
3.3	Behavior with sensor break/ measuring circuit error	9
3.4	Setting of the limit value LC / Extended operating level	9
3.5	Maintenance manager / Error list	10
3.6	Alarm handling	11
3.6.1	Alarm handling limit value LC	11
3.6.2	Alarm handling additional alarms.	12
3.7	Operating structure	13
4	Configuration level	14
4.1	Configuration survey	14
4.2	Configuration	15
5	Parameter setting level.	18
5.1	Parameter survey	18
5.2	Parameters	18
5.3	Input scaling <i>Input</i>	19
6	Calibration level	20
7	BlueControl.	23
8	Versions	24
9	Technical data	25
10	Safety hints	28
10.1	Resetting to factory setting	30

1 Mounting

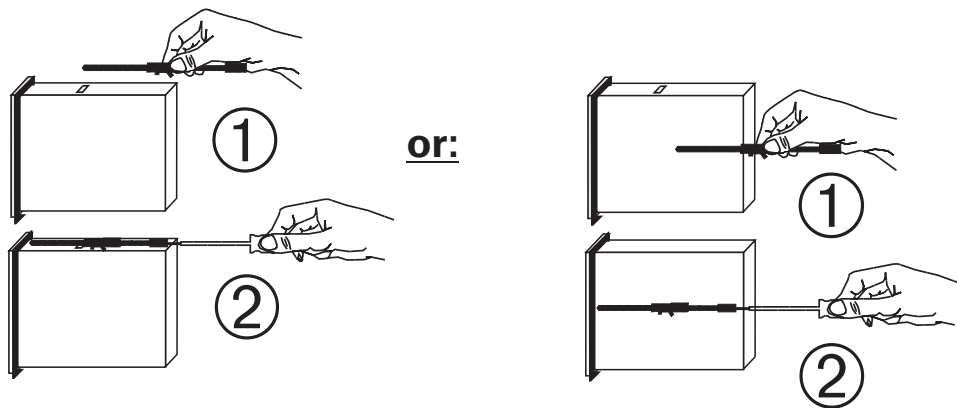
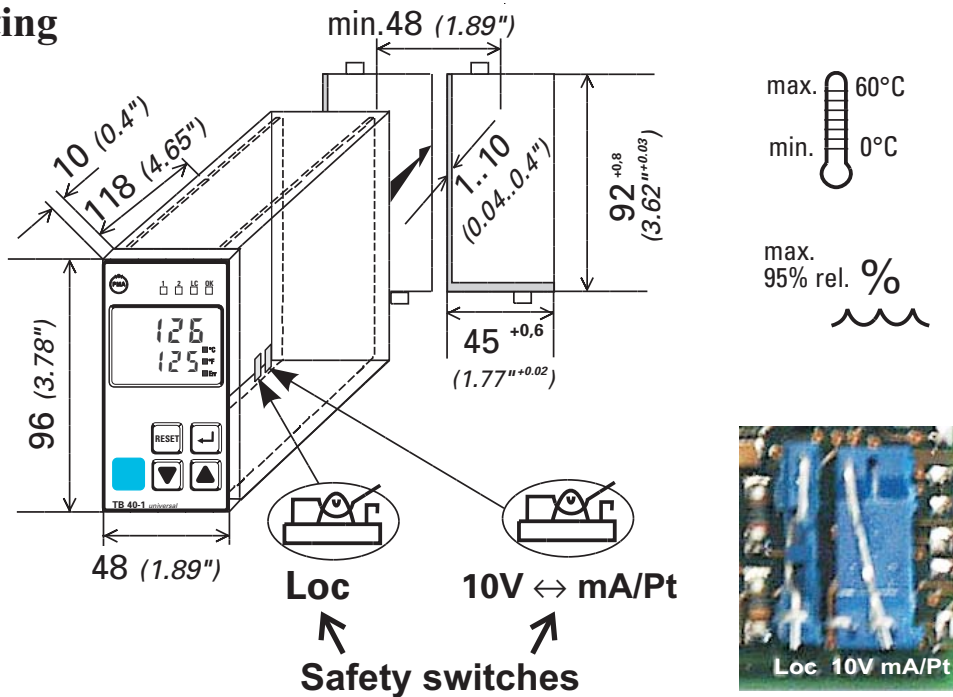

Safety switch:

For access to the safety switches, the controller must be withdrawn from the housing. Squeeze the top and bottom of the front bezel between thumb and forefinger and pull the temperature limiter firmly from the housing.

10V ↔ mA/Pt	right ❶	Current signal / Pt100 / thermocouple at <i>1 n P. 1</i>
	left	Voltage signal at <i>1 n P. 1</i>
Loc	open	Access to all levels locked
	closed ❶	all levels accessible via password <i>P A S S</i>

❶ Factory setting



Safety switch 10V ↔ mA/Pt always in position left or right. Leaving the safety switch open may lead to faulty functions!



Caution! The unit contains ESD-sensitive components.

2 Electrical connections

2.1 Connecting diagram TB 40-1 temperature limiter TB

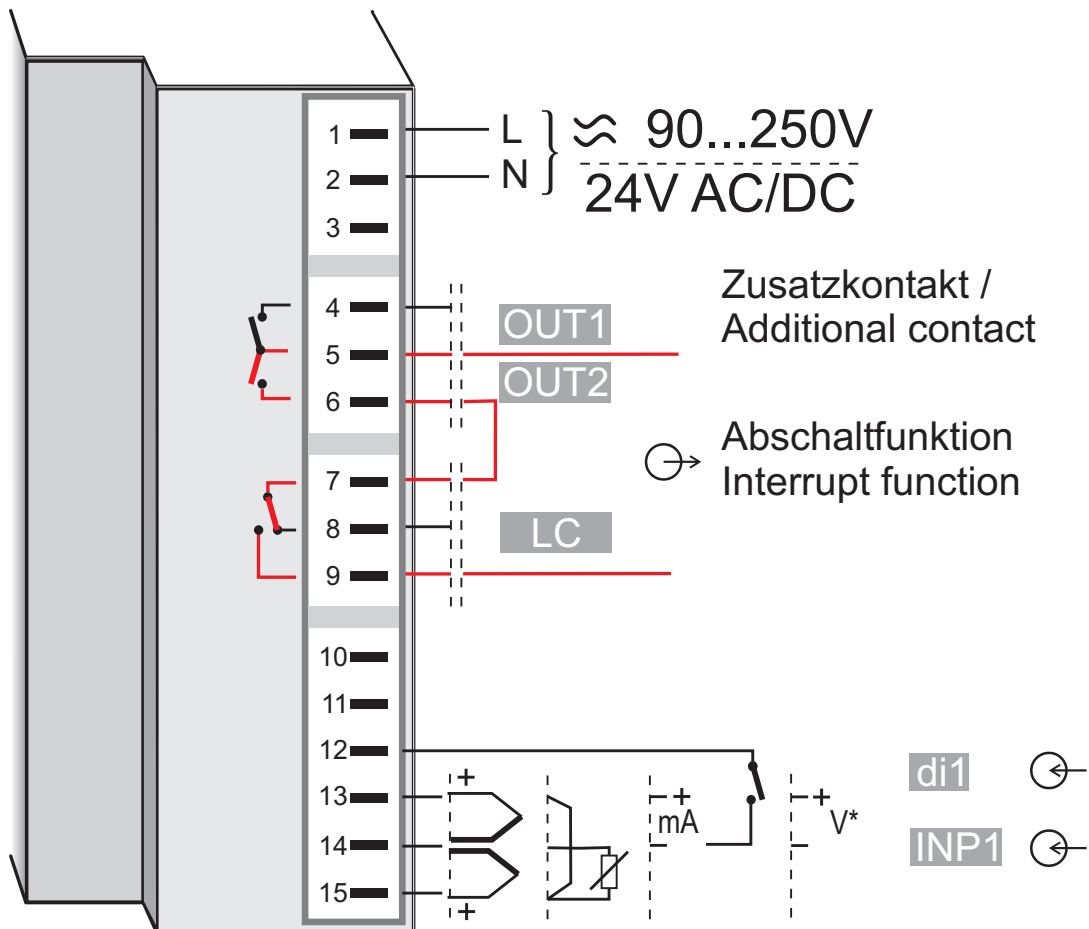

* Safety switch mA \leftrightarrow V in position left



The controller is fitted with

- flat-pin terminals 1 x 6,3mm or 2 x 2,8mm according to DIN 46 244 or
- screw terminals from 0,5 to 2,5mm².

2.1.1 Terminal connection

Power supply connection ①

See chapter "Technical data"

Connection of input INP1 ②

Input for variable x1 (process value)

- a** thermocouple
- b** resistance thermometer (Pt100/ Pt1000/ KTY/ ...)
- c** current (0/4...20mA)
- d** voltage (0/2...10V)

Connection of input di1 ③

Digital input, configurable as switch or push-button

Connection of output **OUT LC** ④

Relay (250V/2A), potential-free changeover contact

Connection of outputs **OUT1/2** ⑤

Relay outputs 250V/2A normally open with common contact connection



The pre-alarms (OUT1/2) must be used only for signalling and not for control purposes!



The pre-alarm OUT2 is available only if configured as **TW!**

TB40-1 connecting example:

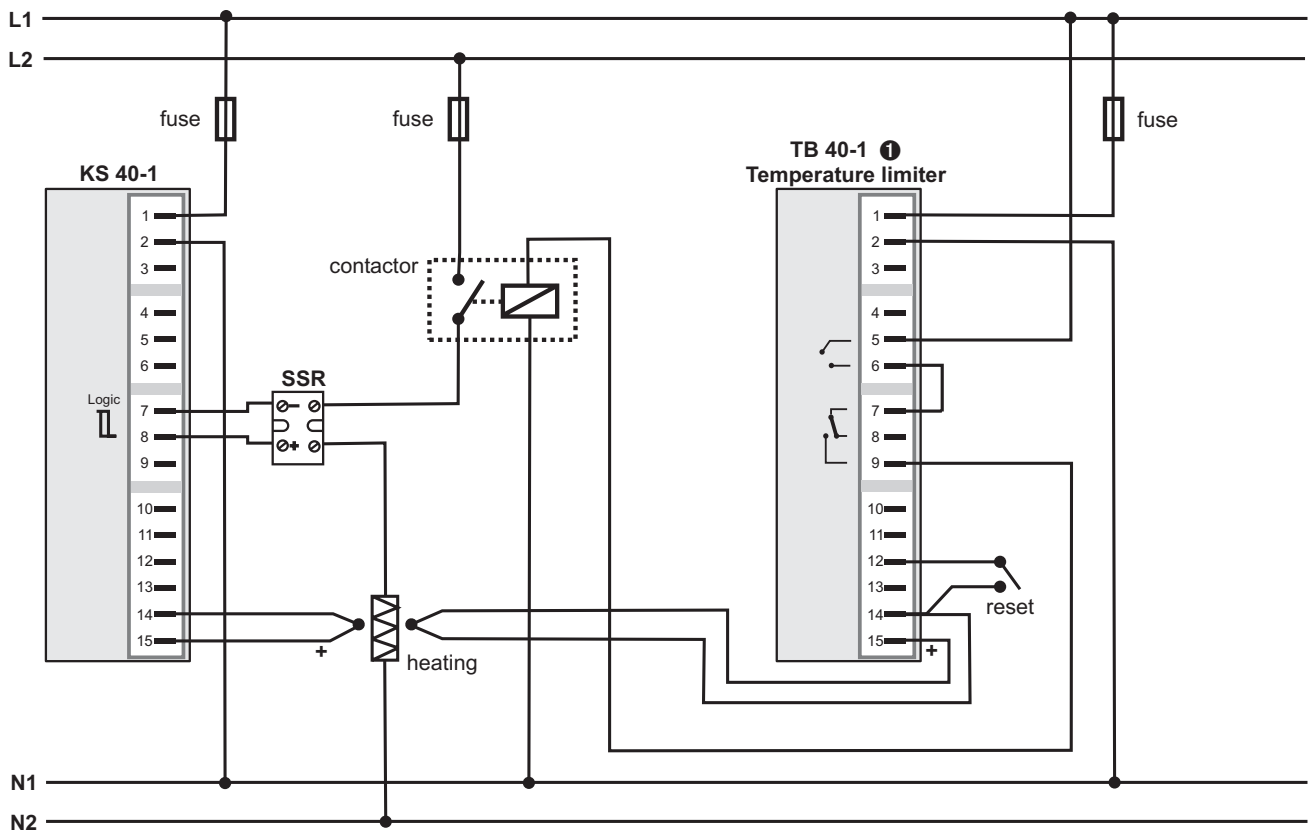

① **TB 40-1 Temperature limiter**
 Standard version (2 relays):
 TB40-102-0000D-000
 → other versions on request



CAUTION:

Using a temperature limiter is recommendable in systems where overtemperature implies a fire hazard or other risks.

2.2 Connecting diagram TB 40-1 temperature monitor TW

The TB 40-1 **temperature limiter** can also be configured as **temperature monitor**. The connection of the 2nd thermocouple is omitted (terminals 12 –13).

Relay contacts OUT1 and OUT2 can be configured as additional limit outputs and connected according to the connecting diagram below. Limit contact LC also is also connected according to the connecting diagram below.

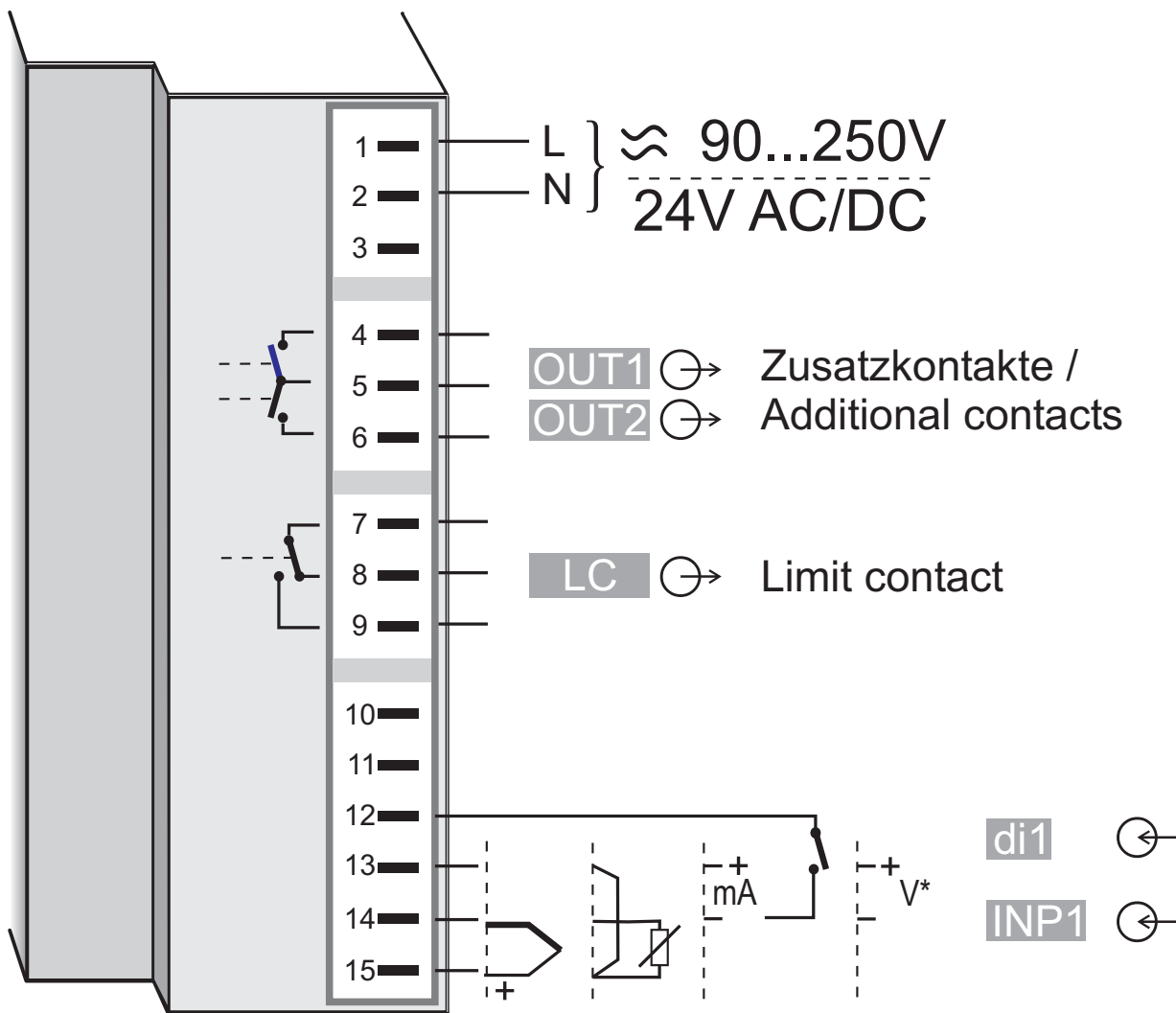

3 Operation

3.1 Front view

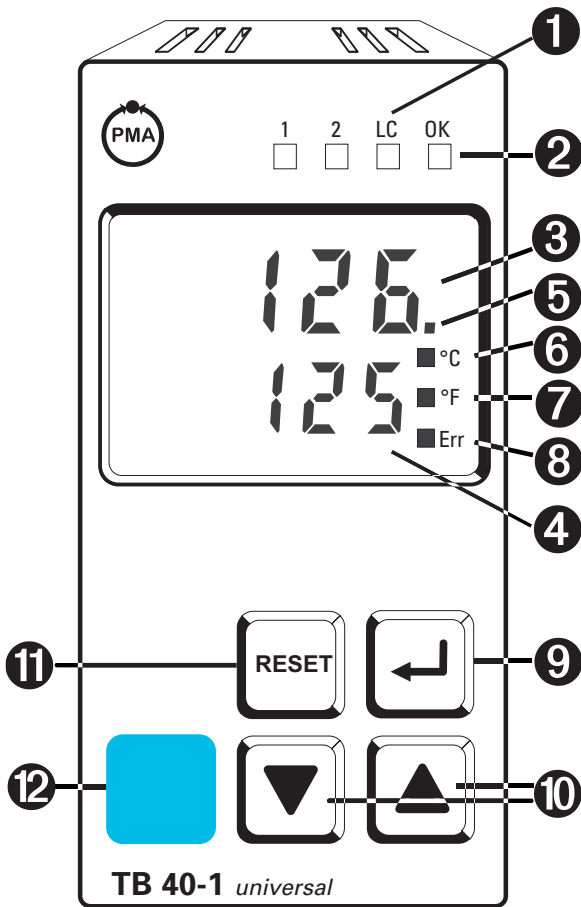

- ① Status of limits
L iñ.2, L iñ.3, LC
- ② Lit with limit value 1
(PArR / L iñ) not exceeded
- ③ Process value display
- ④ Set-point LC
- ⑤ Signals Conf and PArR level
- ⑥ Display in degrees celsius (°C)
- ⑦ Display in degrees fahrenheit (°F)
- ⑧ Entry in error list
- ⑨ Enter key:
calls up extended operating
level / error list
- ⑩ Up/down keys:
changing the set-point or the
controller output value
- ⑪ RESET key for reset of
latched errors
- ⑫ PC connection for BlueControl
(engineering tool)

LED colours:

- LED 1, 2, 3: yellow
- LED OK: green
- other LEDs: red

i In the upper display line, the process value is always displayed (Exception: Conf / other / d iSP = 0). At parameter, configuration, calibration as well as extended operating level, the bottom display line changes cyclically between parameter name and parameter value.

3.2 Behaviour after power-on

After supply voltage switch-on, the unit starts with the **operating level**. The unit is in the condition which was active before power-off.

3.3 Behavior with sensor break/ measuring circuit error

If a sensor break/ measuring circuit error is recognized, the process value display changes to FAIL and the Err-LED blinks. (-> Page 11 chapter 3.5 maintenance manager/ error list). All configured alarm limits are handled as exceeded, the appropriate Outputs are switched. The OK-LED ceases and the LC Output is opened.

3.4 Setting of the limit value LC / Extended operating level

Setting of the limit value LC

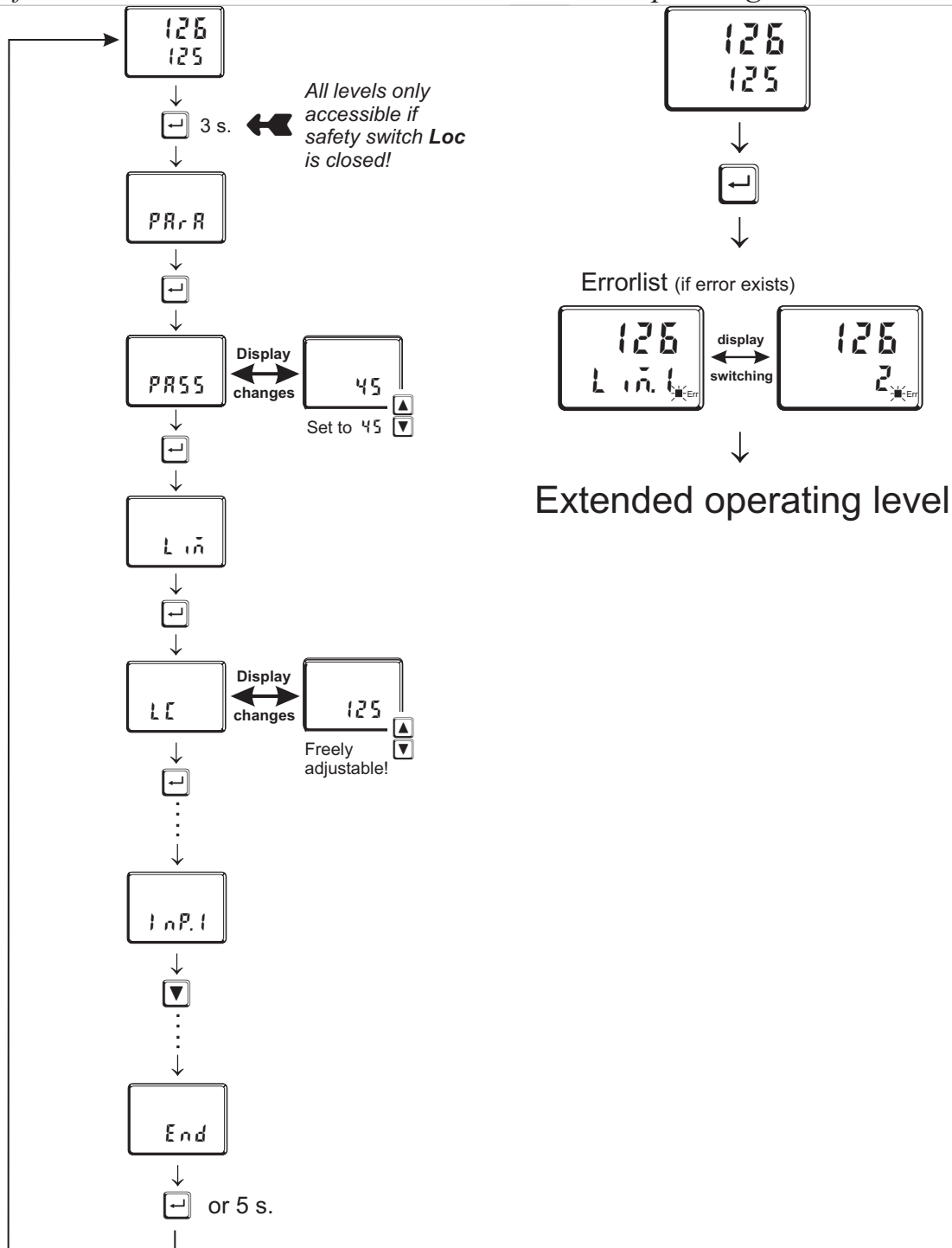

Extended operating level



3.5 Maintenance manager / Error list



With one or several errors, the extended operating level always starts with the error list. Signalling an actual entry in the error list (alarm, error) is done by the Err LED in the display. To reach the error list press  twice.



Err LED status	Signification	Proceed as follows
blinks	Alarm due to existing error	<ul style="list-style-type: none"> - Determine the error type in the error list via the error number - Remove the error
lit	Error removed, Alarm not acknowledged	<ul style="list-style-type: none"> - Acknowledge the alarm in the error list pressing key  or  - The alarm entry was deleted.
off	No error, all alarm entries deleted	

Error list:

Name	Description	Cause	Possible remedial action
E.1	Internal error, cannot be removed	- E.g. defective EEPROM	<ul style="list-style-type: none"> - Contact PMA service - Return unit to our factory
E.2	Internal error, can be reset	- e.g. EMC trouble	<ul style="list-style-type: none"> - Keep measurement and power supply cables in separate runs - Ensure that interference suppression of contactors is provided
FbF.1	Sensor break INP1	<ul style="list-style-type: none"> - Sensor defective - Faulty cabling 	<ul style="list-style-type: none"> - Replace INP1 sensor - Check INP1 connection
ShE.1	Short circuit INP1	<ul style="list-style-type: none"> - Sensor defective - Faulty cabling 	<ul style="list-style-type: none"> - Replace INP1 sensor - Check INP1 connection
POL.1	INP1 polarity error	- Faulty cabling	- Reverse INP1 polarity
L n.1	Stored LC alarm	- adjusted limit value LC exceeded	- check process
L n.2	Stored alarm 2	- adjusted limit value alarm 2 exceeded	- check process
L n.3	Stored alarm 3	- adjusted limit value alarm 3 exceeded	- check process
Inf.1	time limit value message	- adjusted number of operating hours reached	- application-specific

- 
 Saved alarms (Err-LED is lit) can be acknowledged and deleted with the digital input di1 or the RESET-key.
 Configuration, see page : `CONF / LOG1 / Error`
- 
 If an alarm is still valid that means the cause of the alarm is not removed so far (Err-LED blinks), then other saved alarms can not be acknowledged and deleted.

Error status:

Error status	Signification	
2	Existing error	Change to error status 1 after error removal
1	Stored error	Change to error status 0 after acknowledgement in error list
0	No error/message	not visible, except with acknowledgement

3.6 Alarm handling

3.6.1 Alarm handling limit value LC

Method of operation upper limit:
 (`CONF / LIN / Fcn.1 = 3`)

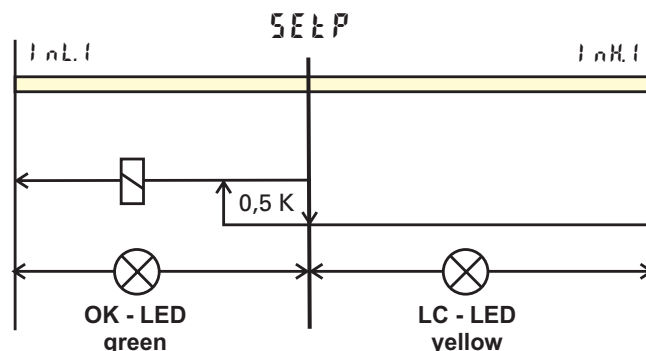

Method of operation lower limit:
 (`CONF / LIN / Fcn.1 = 4`)

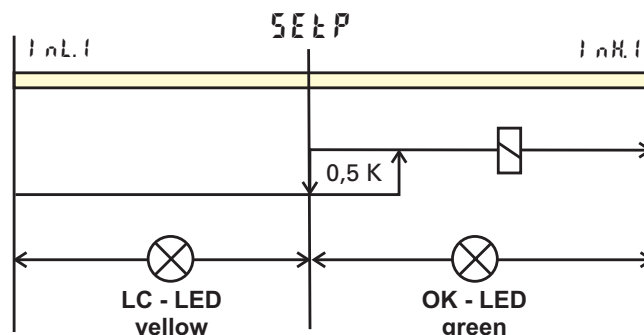

3.6.2 Alarm handling additional alarms

Max. two alarms can be configured and assigned to the individual outputs. Generally, outputs $OUT.1$ and $OUT.2$ can be used each for alarm signalling. Each of the 2 limit values $L.1.2$ and $L.1.3$ has 2 trigger points $H.2/H.3$ (Max) and $L.2/L.3$ (Min), which can be switched off individually (parameter = "OFF"). Switching difference $HYS.2/HYS.3$ of each limit value is adjustable.

① Operating principle $SETP.x = 0$
 $L.1 = OFF$

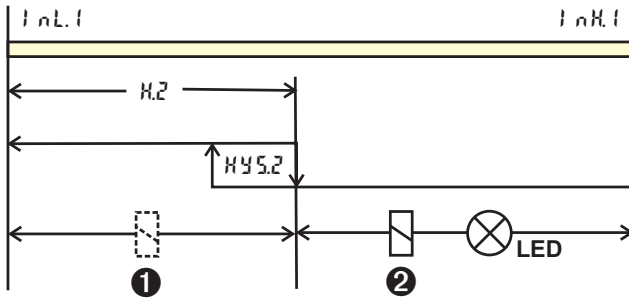

② Operating principle $SETP.x = 1$
 $L.1 = OFF$

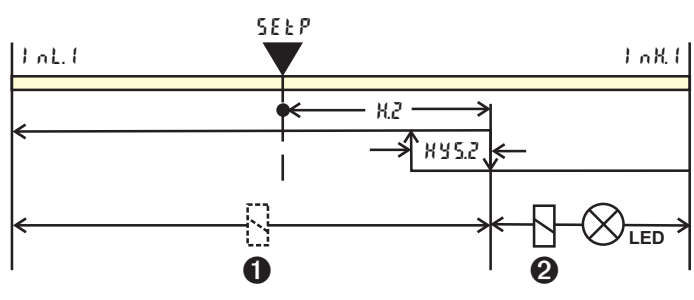

$H.1 = OFF$

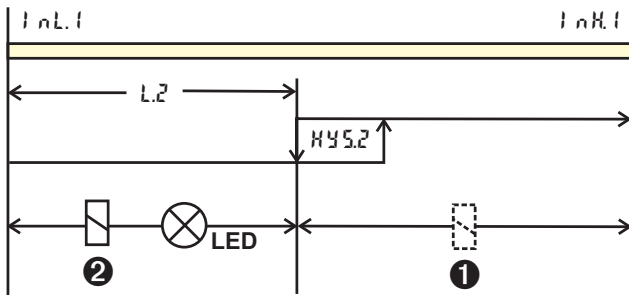

$H.1 = OFF$

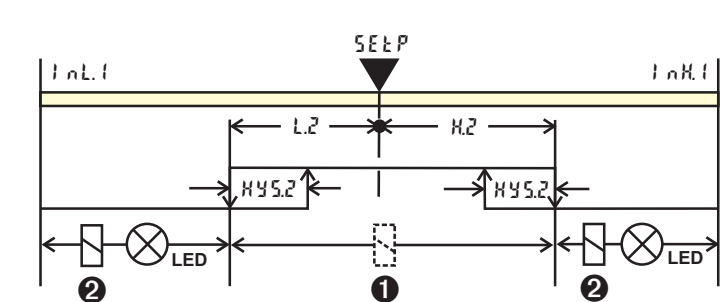
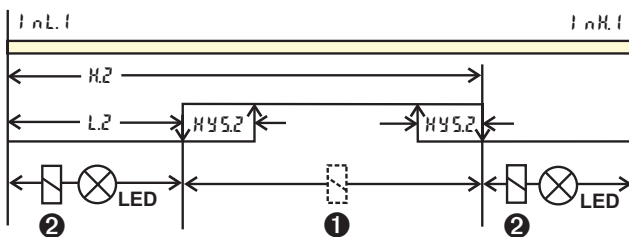
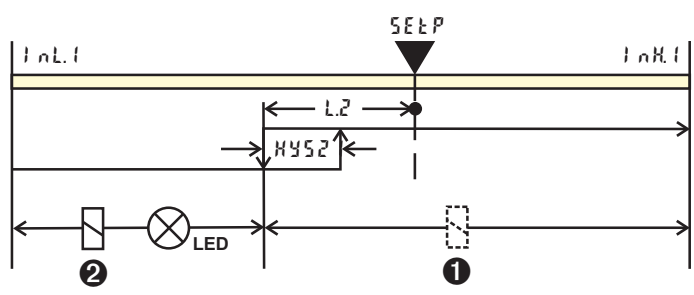

①: normally closed ($CONF/OUT.x/RECT = 1$)

②: normally open ($CONF/OUT.x/RECT = 0$)



The pre-alarms (OUT1/2) must be used only for signalling and not for control purposes!

i The variable to be monitored can be selected separately for each alarm via configuration

The following variables can be monitored:

- process value
- control deviation xw (process value - LC limit (LC))

3.7 Operating structure

After supply voltage switch-on, the controller starts with the **operating levels**. The controller status is as before power off.

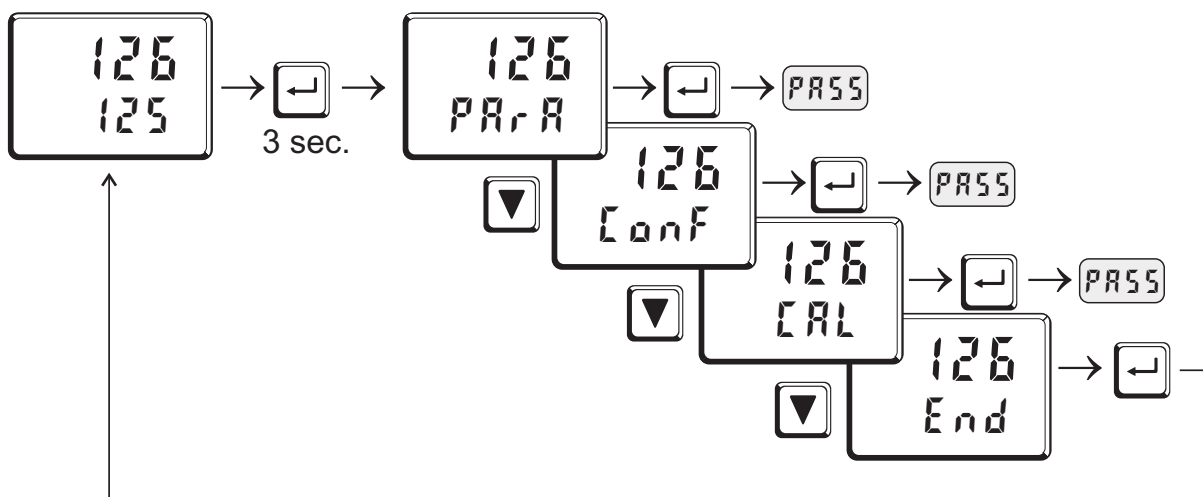

i **PARA** - level: At **PARA** - level, the right decimal point of the upper display line is *lit continuously*.

i **CONF** - level: At **CONF** - level, the right decimal point of the upper display line *blinks*.

PASS

All levels are only accessible by entry of the password **PASS** .
When safety switch **Loc** is open, no access to all levels is possible.

Factory setting:

Safety switch **Loc** closed: all levels accessible without restriction, password **PASS** = 45 .

Safety switch Loc	Password entered with BluePort®	Function disabled or enabled with BluePort®	Access via the instrument front panel:
closed	OFF / password	disabled / enabled	enabled
open	OFF / password	disabled	disabled
open	OFF	enabled	enabled
open	Password	enabled	enabled after password entry

4 Configuration level

4.1 Configuration survey

CONF Configuration level							
	Limit value functions	Input 1	Output 2	Output 3	Digital inputs	Display	End
▲	Fnc.1	StYP	ORct	ORct	Errr	Unit	
▼	Fnc.2	SL in				dP	
	Src.2	Corr				dISP	
	Fnc.3						
	Src.3						



Adjustment:

- The configuration can be adjusted by means of keys ▲▼ .
- Transition to the next configuration is by pressing key ↵ .
- After the last configuration of a group, done is displayed and followed by automatic change to the next group



Return to the beginning of a group is by pressing the ↵ key for 3 sec.

4.2 Configuration

Limit

Name	Value range	Description	Default
Fcn.1		Function of limit 1	7
	5	Measured value monitoring upper limit (no latching)	TW ①
	6	Measured value monitoring lower limit (no latching)	TW ①
	7	Measured value monitoring + latching of the alarm status of the upper limit. A latched alarm can be reset by the error list, the digital input or the RESET-key (-> LOGI / Err.r).	TB ①
	8	Measured value monitoring + latching of the alarm status of the lower limit. A latched alarm can be reset by the error list, the digital input or the RESET-key (-> LOGI / Err.r).	TB ①
Fcn.2 / 3		Function of limit 2 / 3	0 / 0
	0	switched off	
	1	measured value monitoring	
	2	Measured value monitoring + latching of the alarm status. A latched alarm can be reset by the error list, the digital input DI1 or the RESET-key (-> LOGI / Err.r).	
Src.2 / 3		Source of limit 2 / 3	0 / 0
	0	process value	
	1	control deviation xw (process value - set-point)	
Hour	OFF...10000	Operating hours (only visible with BlueControl!)	OFF
Sp.it	OFF...10000	Output switching cycles (only visible with BlueControl!)	OFF

① TW: Temperature monitor
TB: Temperature limiter

 Fcn.3, Src.3 only available if Fcn.1 is configured as TW

InP.1

Name	Value range	Description	Default
SEYP		Sensor type selection	1
	0	thermocouple type L (-100...900°C), Fe-CuNi (DIN)	
	1	thermocouple type J (-100...1200°C), Fe-CuNi	
	2	thermocouple type K (-100...1350°C), NiCr-Ni	
	3	thermocouple type N (-100...1300°C), Nicrosil-Nisil	
	4	thermocouple type S (0...1760°C), PtRh-Pt10%	
	5	thermocouple type R (0...1760°C), PtRh-Pt13%	
	6	thermocouple type T (-200...400°C), Cu-CuNi	
	7	thermocouple type C (0...2315°C), W5%Re-W26%Re	
	8	thermocouple type D (0...2315°C), W3%Re-W25%Re	
	9	thermocouple type E (-100...1000°C), NiCr-CuNi	
	10	thermocouple type B (0/100...1820°C), PtRh-Pt6%	
	18	special thermocouple	

Configuration level

Name	Value range	Description	Default
	20	Pt100 (-200.0 ... 100,0 °C)	
	21	Pt100 (-200.0 ... 850,0 °C)	
	22	Pt1000 (-200.0 ... 850.0 °C)	
	23	special 0...4500 Ohm (preset to KTY11-6)	
	24	special 0...450 Ohm	
	30	0...20mA / 4...20mA ❶	
	40	0...10V / 2...10V ❶	
S.L in		Linearization (only at S.tYP = 23 (KTY 11-6), 24 (0...450Ω), 30 (0..20mA), 40 (0..10V) and 41 (0...100mV))	0
	0	none	
	1	Linearization to specification. Creation of linearization table with engineering tool possible. The characteristic for KTY 11-6 temperature sensors is preset.	
Corr		Measured value correction / scaling	0
	0	Without scaling	
	1	Offset correction (at ϵRL level)	
	2	2-point correction (at ϵRL level)	
	3	Scaling (at $PRR R$ level)	

❶ with current and voltage input signals, scaling is required (see chapter 5.3)



For application as temperature limiter for one thermocouple a dual thermocouple must be connected

Out.1

Name	Value range	Description	Default
O.Rct		Method of operation OUT1	0
	0	direct / normally open	
	1	inverse / normally closed	

Out.2 only available if $Fcn.1 = TW$

Name	Value range	Description	Default
O.Rct		Method of operation OUT2	0
	0	direct / normally open	
	1	inverse / normally closed	

LOG1

Name	Value range	Description	Default
Err.r		Reset of all limit alarms	6
	2	DI1	
	6	RESET- key	

o b h r

Name	Value range	Description	Default
Unit		Unit	1
	0	without unit	
	1	°C	
	2	°F	
dP		Decimal point (max. number of digits behind the decimal point)	0
	0	No digit behind the decimal point	
	1	1 digit behind the decimal point	
	2	2 digits behind the decimal point	
	3	3 digits behind the decimal point	
dISP		Type of measured value display	1
	0	No measured value display	
	1	Full display resolution	
	2	Display resolution: 2 digits	
	3	Display resolution: 5 digits	
	4	Display resolution: 10 digits	
EdEL	0..200	Modem delay [ms]	0
FrEQ		Switching 50 Hz / 60 Hz (only visible with BlueControl!)	0
	0	50 Hz	
	1	60 Hz	

 **Resetting the device configuration to factory setting (Default)**
 → chapter 10.1 (page 30)

 **BlueControl - the engineering tool for the BluePort® controller series**

3 engineering tools with different functionality facilitating TB40-1 configuration and parameter setting are available (see chapter 8: *Accessory equipment with ordering information*).

In addition to configuration and parameter setting, the engineering tools are used for data acquisition and offer long-term storage and print functions. The engineering tools are connected to TB40-1 via the front-panel interface "BluePort®" by means of PC and a PC adaptor.

Description BlueControl: see chapter 7: *BlueControl* (page 23).



5 Parameter setting level

5.1 Parameter survey

Parameter setting level

Limit value functions	Input 1	LC setting range	End
LC	InL.1	rnGL	
L2	OutL.1	rnGH	
H2	InH.1		
HYS.2	OutH.1		
L3	EF.1		
H3			
HYS.3			

i Adjustment:

- The parameters can be adjusted by means of keys  
- Transition to the next parameter is by pressing key 
- After the last parameter of a group, **donE** is displayed, followed by automatic change to the next group.

 Return to the beginning of a group is by pressing the  key for 3 sec.

5.2 Parameters

L n

Name	Value range	Description	Default
LC	-1999...9999	LC limit	100
L2	-1999...9999	Lower limit 2	OFF
H2	-1999...9999	Upper limit 2	OFF
HYS.2	0...9999	Hysteresis limit 2	1
L3	-1999...9999	Lower limit 3	OFF
H3	-1999...9999	Upper limit 3	OFF
HYS.3	0...9999	Hysteresis limit 3	1

L3, H3, HYS.3 only available if Fcn.1 = TW

InP.1

Name	Value range	Description	Default
InL.1	-1999...9999	Input value for the lower scaling point	0
OutL.1	-1999...9999	Displayed value for the lower scaling point	0
InH.1	-1999...9999	Input value for the upper scaling point	20
OutH.1	-1999...9999	Displayed value for the upper scaling point	20
EF.1	-1999...9999	Filter time constant [s]	0,5

r n L

Name	Value range	Description	Default
r n L	-1999...9999	Set-point limit low for set-point LC	-1999
r n H	-1999...9999	Set-point limit high for set-point LC	9999

- i** **Resetting the device configuration to factory setting (Default)**
→ chapter 10.1 (page 30)

5.3 Input scaling I n P. I

When using current or voltage signals as input variables for I n P. I scaling of input and display values at parameter setting level is required. Specification of the input value for lower and higher scaling point is in the relevant electrical unit (mA/ V).

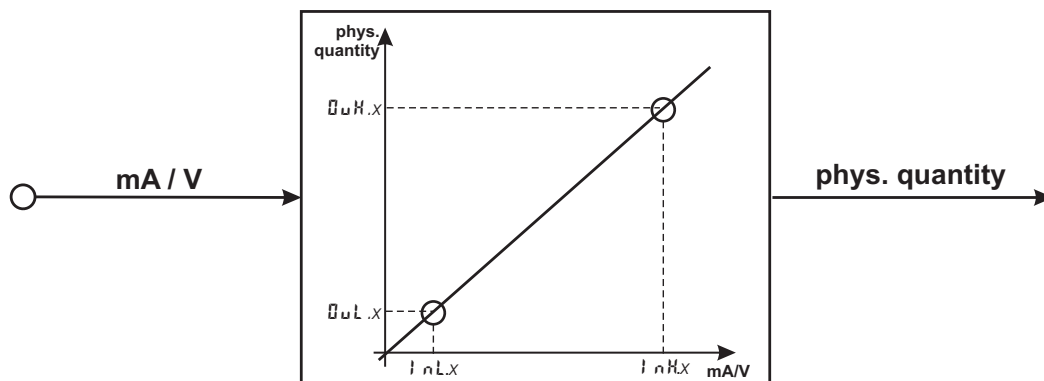

- i** Parameters I n L. I, Q u L. I, I n H. I and Q u H. I are only visible if CONF / I n P. I / Corr = 3 is chosen.

StYP	Input signal	I n L. I	Q u L. I	I n H. I	Q u H. I
30 (0...20mA)	0 ... 20 mA	0	any	20	any
	4 ... 20 mA	4	any	20	any
40 (0...10V)	0 ... 10 V	0	any	10	any
	2 ... 10 V	2	any	10	any

In addition to these settings, I n L. I and I n H. I can be adjusted in the range (0...20mA / 0...10V) determined by selection of StYP .

- !** For using the predetermined scaling with thermocouple and resistance thermometer (Pt100), the settings for I n L. I and Q u L. I and for I n H. I and Q u H. I must have the same value.

- i** Input scaling changes at calibration level (→ page 20) are displayed by input scaling at parameter setting level. After calibration reset (OFF), the scaling parameters are reset to default.

6 Calibration level

i Measured value correction (ϵ_{RL}) is only visible if $\epsilon_{conf} / \epsilon_{inp.1} / \epsilon_{corr} = 1$ or 2 is chosen.

The measured value can be matched in the calibration menu (ϵ_{RL}). Two methods are available:

Offset correction

($\epsilon_{conf} / \epsilon_{inp.1} / \epsilon_{corr} = 1$):

- possible on-line at the process

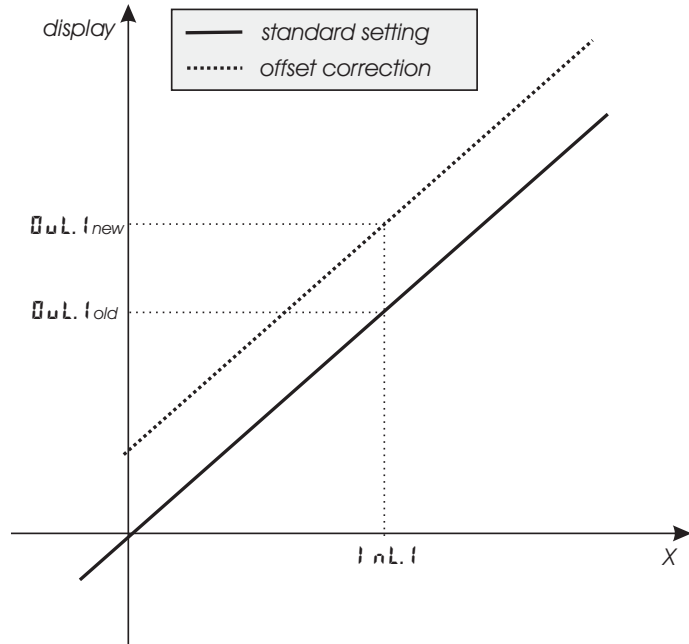

2-point correction

($\epsilon_{conf} / \epsilon_{inp.1} / \epsilon_{corr} = 2$):

- is possible off-line with process value simulator

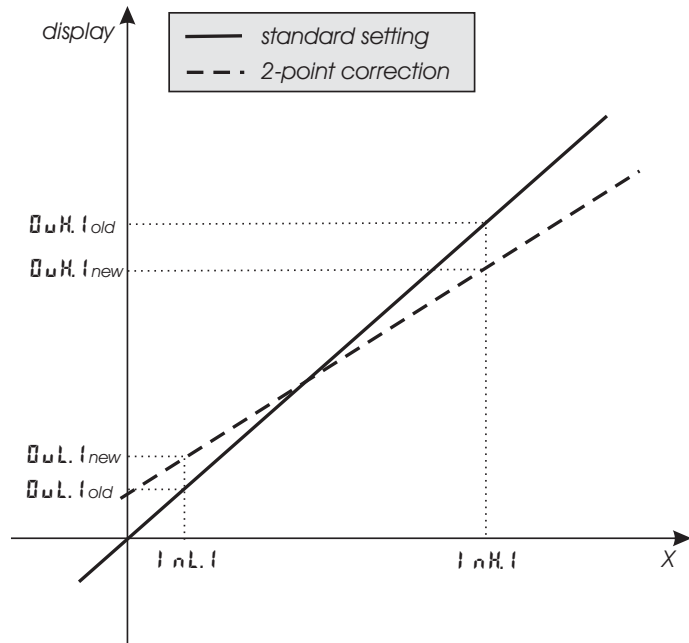



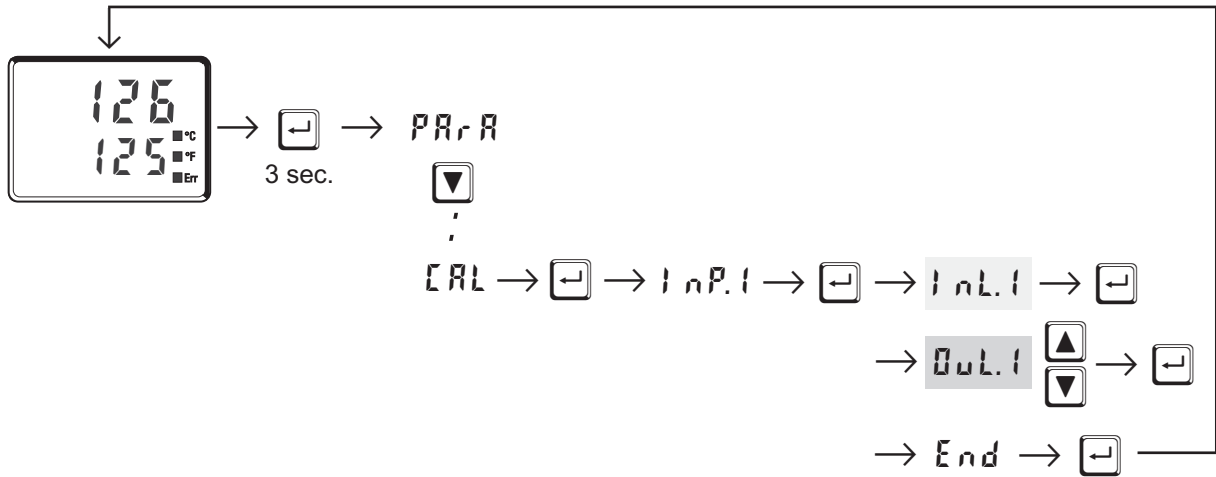



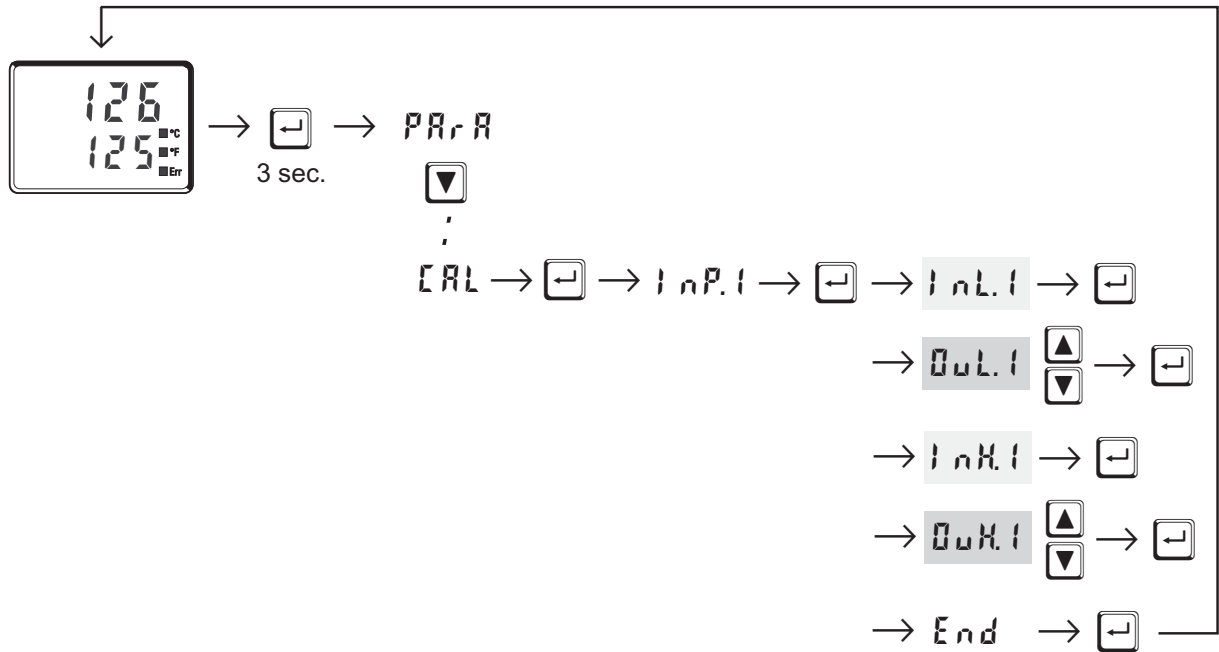

Offset correction (CONF / InP.1 / Err = 1):



- InL.1:** The input value of the scaling point is displayed.
The operator must wait, until the process is at rest.
Subsequently, the operator acknowledges the input value by pressing key .
- Out.1:** The display value of the scaling point is displayed.
Before calibration, **Out.1** is equal to **InL.1**.
The operator can correct the display value by pressing keys .
Subsequently, he confirms the display value by pressing key .

2-point correction (CONF / INP.1 / CORR = 2):



- InL.1:** The input value of the lower scaling point is displayed.
The operator must adjust the lower input value by means of a process value simulator and confirm the input value by pressing key .
- OutL.1:** The display value of the lower scaling point is displayed.
Before calibration, **OutL.1** equals **InL.1**.
The operator can correct the lower display value by pressing the  keys. Subsequently, he confirms the display value by pressing key .
- InH.1:** The input value of the upper scaling point is displayed. .
The operator must adjust the upper input value by means of the process value simulator and confirm the input value by pressing key .
- OutH.1:** The display value of the upper scaling point is displayed.
Before calibration **OutH.1** equals **InH.1**.
The operator can correct the upper display value by pressing keys . Subsequently, he confirms the display value by pressing key .

 The parameters (**OutL.1**, **OutH.1**) changed at **CAL** level can be reset by adjusting the parameters below the lowest adjustment value (**OFF**) by means of decrement key .

7 BlueControl

BlueControl is the projection environment for the BluePort[®] controller series of PMA. The following 3 versions with graded functionality are available:

FUNCTIONALITY	MINI	BASIC	EXPERT
parameter and configuration setting	yes	yes	yes
controller and loop simulation	yes	yes	yes
download: trnsfer of an engineering to the controller	yes	yes	yes
online mode/ visualization	SIM only	yes	yes
defining an application specific linearization	yes	yes	yes
configuration in the extended operating level	yes	yes	yes
upload: reading an engineering from the controller	SIM only	yes	yes
basic diagnostic functions	no	no	yes
saving data file and engineering	no	yes	yes
printer function	no	yes	yes
online documentation, help	yes	yes	yes
implementation of measurement value correction	yes	yes	yes
data acquisition and trend display	SIM only	yes	yes
wizard function	yes	yes	yes
extended simulation	no	no	yes
programmeditor (KS 90-1prog only)	no	no	yes

The mini version is - free of charge - at your disposal as download at PMA home-page www.pma-online.de or on the PMA-CD (please ask for).

At the end of the installation the licence number has to be stated or DEMO mode must be chosen.

At DEMO mode the licence number can be stated subsequently under *Help* → *Li-
cence* → *Change*.

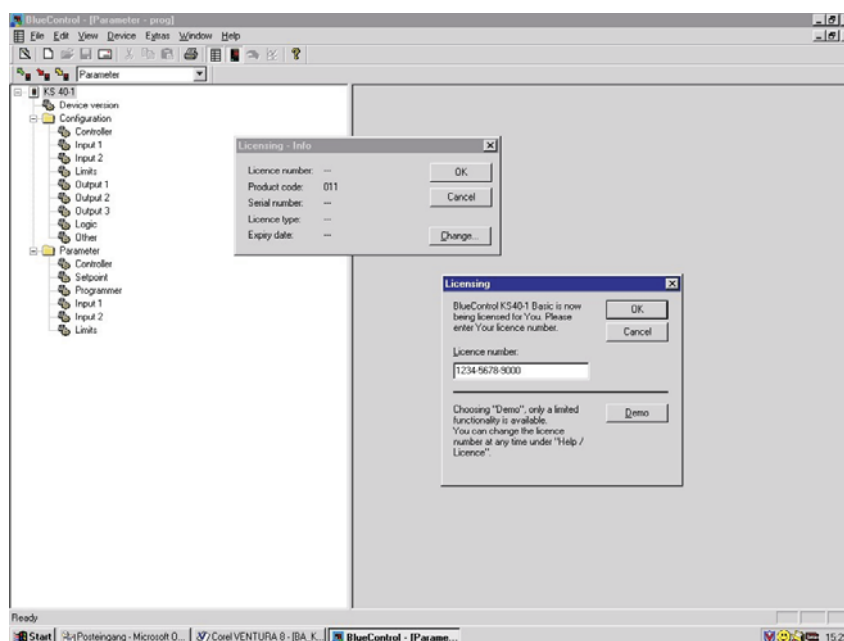

8 Versions

	T	B	4	0	-	1											
Flat pin connectors										0	↑						
Screw terminal connectors										1	↑						
90..250V AC, 3 relays,										TW	¹⁾	0					
24VAC / 18..30VDC, 3 relays,										TW	¹⁾	1					
90..250V AC, 2 relays,										TB	²⁾	2					
24VAC / 18..30VDC, 2 relays,										TB	²⁾	3					
Standard configuration												0					
Configuration to specification												9					
No manual													0				
Manual German													D				
Manual English													E				
Manual French													F				
Standard CE-certified)														0			
cULus certified (with screw terminals only!) ³⁾														U			
EN14597 certified (replaces DIN 3440)														D			
Standard version																	00
Customer specification																	..

1) Temperature monitor
 2) Temperature limiter TB (EN14597, 2009-1), not available with cULus
 3) Not available as Temperature limiter TB (EN14597, 2009-1)

Accessories delivered with the unit

Operating manual (if selected by the ordering code)

- 2 fixing clamps
- operating note in 15 languages

Accessory equipment with ordering information

Description			Order no.
PC-adaptor for the front-panel interface			9407-998-00001
Standard rail adaptor			9407-998-00061
Operating manual	German		9499-040-93418
Operating manual	English		9499-040-93411
BlueControl (engineering tool)	Mini	Download	www.pma-online.de
BlueControl (engineering tool)	Basic		9407-999-11001
BlueControl (engineering tool)	Expert		9407-999-11011

9 Technical data

INPUTS

PROCESS VALUE INPUT INP1

Resolution: > 14 bits
 Decimal point: 0 to 3 digits behind the decimal point
 Dig. input filter: adjustable 0,000...9999 s
 Scanning cycle: 100 ms
 Measured value correction: 2-point or offset correction

Thermocouples

→ Table 1 (page 27)

If the device is used as a teperature limiter, a double thermocouple must be connected. For measurements in the area of ambient temperature (0mV) the plausibility is ensured by the control of the 2nd thermocouple. Outside of this range there is no check of the 2nd thermocouple.

Input resistance: $\geq 1 \text{ M}\Omega$
 Effect of source resistance: $1 \mu\text{V}/\Omega$

Cold-junction compensation

Maximal additional error: $\pm 0,5 \text{ K}$

Sensor break monitoring

Sensor current: $\leq 1 \mu\text{A}$
 Configurable output action

Resistance thermometer

→ Table 2 (page 27)

Connection: 2 or 3-wire
 Lead resistance: max. 30 Ohm
 Input circuit monitor: break and short circuit

Special measuring range

BlueControl (engineering tool) can be used to match the input to sensor KTY 11-6 (characteristic is stored in the controller).

Physical measuring range: 0...4500 Ohm
 Linearization segments 16

Current and voltage signals

→ Table 3 (page 27)

Span start, end of span: anywhere within measuring range
 Scaling: selectable -1999...9999
 Linearization: 16 segments, adaptable with BlueControl
 Decimal point: adjustable
 Input circuit monitor: 12,5% below span start (2mA, 1V)

CONTROL INPUT DI1

Configurable as switch or push-button!
 Connection of a potential-free contact suitable for switching "dry" circuits.

Switched voltage: 2,5 V
 Current: 50 μA

GALVANIC ISOLATION

— Safety isolation
 === Function isolation

Power supply connections	Process value input INP1
	Digital input di1
Relay outputs OUT 1,2	
Relay output OUTLC	

OUTPUTS

OUTPUT LC

Function:
 Interruption of the power supply if the set limit is exceeded or fallen short.

Contact type: potential-free changeover contact
 Max.contact rating: 500 VA, 250 V, 2A at 48...62 Hz, resistive load
 Min. contact rating: 5V, 10 mA AC/DC
 Operating life (electr.): 600.000 duty cycles with max. contact rating

If the device is used as **temperature limiter** (configuration date **Fcn. 1** = 7 or 8) the bridge between **clamps 6 and 7 must not be removed!** The bridge ensures the safe interruption of power by serial switching of the relays LC and OUT2. If the device is utilized as temperature monitor (configuration date **Fcn. 1** = 5 or 6) the bridge can be removed, the break is only via LC relay

OUTPUTS OUT1, OUT2

Function:
 Additional alarms with MAX, MIN or MAX+MIN monitoring with adjustable hysteresis.
 Monitored signals:

- process value (absolut)
 - difference to the limit (relative)
 - sensor break / short circuit
- According to the input type, the input signal is monitored to sensor break, polarity error and short circuit

Technical data

Contact type:	2 NO contacts with common connection
Max. contact rating:	500 VA, 250 V, 2A at 48...62 Hz, resistive load
Min. contact rating:	6V, 1 mA DC
Operating life (electr.):	800.000 duty cycles with max. rating

Note:

If the relays OUT1...OUT LC operate external contactors, these must be fitted with RC snubber circuits to manufacturer specifications to prevent excessive switch-off voltage peaks.

POWER SUPPLY

Dependent of order

AC SUPPLY

Voltage:	90...250 V AC
Frequency:	48...62 Hz
Power consumption	approx. 7.3 VA

UNIVERSAL SUPPLY 24 V UC

AC voltage:	20,4...26,4 V AC
Frequency:	48...62 Hz
DC voltage:	18...31 V DC
Power consumption:	approx.. 7.3 VA

BEHAVIOUR WITH POWER FAILURE

Configuration, parameters and adjusted set-points, control mode:

Non-volatile storage in EEPROM

BLUEPORT FRONT INTERFACE

Connection of PC via PC adapter (see "Accessory equipment"). The BlueControl software is used to configure, set parameters and operate the TB40-1.

ENVIRONMENTAL CONDITIONS

Protection modes

Front panel:	IP 65 (NEMA 4X)
Housing:	IP 20
Terminals:	IP 00

Permissible temperatures

For specified accuracy:	0...60°C
Warm-up time:	≥ 15 minutes
For operation:	-20...65°C
For storage:	-40...70°C

Humidity

75% yearly average, no condensation

Altitude

To 2000 m above sea level

Shock and vibration

Vibration test Fc (DIN 68-2-6)

Frequency:	10...150 Hz
Unit in operation:	1g or 0,075 mm
Unit not in operation:	2g or 0,15 mm

Shock test Ea (DIN IEC 68-2-27)

Shock:	15g
Duration:	11ms

Electromagnetic compatibility

Complies with EN 61 326-1

(for continuous, non-attended operation)

GENERAL

Housing

Material:	Makrolon 9415 flame-retardant
Flammability class:	UL 94 V0, self-extinguishing

Plug-in module, inserted from the front

Safety test

Complies with EN 61010-1 (VDE 0411-1):

Overvoltage category II

Contamination class 2

Working voltage range 300 V

Protection class II

Certifications

Type tested to EN 14597 (2009-1)

With certified sensors applicable for:

- Heat generating plants with outflow temperatures up to 120°C to DIN 4751
- Hot-water plants with outflow temperatures above 110°C to DIN 4752
- Thermal transfer plants with organic transfer media to DIN 4754
- Oil-heated plants to DIN 4755

Electrical connections

According to order:

- - flat-pin terminals 1 x 6,3mm or 2 x 2,8mm according to DIN 46 244 or
- screw terminals from 0,5 to 2,5mm².

Mounting

Panel mounting with two fixing clamps at top/bottom or right/left. High-density mounting possible

Mounting position: uncritical
Weight: 0,27kg

Accessories delivered with the unit

Operating manual
Fixing clamps

Table 1 Thermocouple measuring ranges

Type	Range	Accuracy	Resolution (∅)		
L	Fe-CuNi (DIN)	-100...900°C	-148...1652°F	≤ 2K	0,1 K
J	Fe-CuNi	-100...1200°C	-148...2192°F	≤ 2K	0,1 K
K	NiCr-Ni	-100...1350°C	-148...2462°F	≤ 2K	0,2 K
N	Nicrosil/Nisil	-100...1300°C	-148...2372°F	≤ 2K	0,2 K
S	PtRh-Pt 10%	0...1760°C	32...3200°F	≤ 2K	0,2 K
R	PtRh-Pt 13%	0...1760°C	32...3200°F	≤ 2K	0,2 K
T	Cu-CuNi	-200...400°C	-328...752°F	≤ 2K	0,05 K
C	W5%Re-W26%Re	0...2315°C	32...4199°F	≤ 2K	0,4 K
D	W3%Re-W25%Re	0...2315°C	32...4199°F	≤ 2K	0,4 K
E	NiCr-CuNi	-100...1000°C	-148...1832°F	≤ 2K	0,1 K
B*	PtRh-Pt6%	0(100)...1820°C	32(212)...3308°F	≤ 2K	0,3 K

* Specifications valid from 400°C

Table 2 Resistance transducer measuring ranges

Type	Sens. current	Range	Accuracy	Resolution (∅)	
Pt100	0,2mA	-200...100°C	-140...212°F	≤ 1K	0,1K
Pt100		-200...850°C	-140...1562°F	≤ 1K	0,1K
Pt1000		-200...850°C	-140...392°F	≤ 2K	0,1K
KTY 11-6*		-50...150°C	-58...302°F	≤ 2K	0,05K

* Or special

Table 3 Current and voltage measuring ranges

Range	Input resistance	Accuracy	Resolution (∅)
0-10 Volt	≈ 110 kΩ	≤ 0,1 %	≤ 0,6 mV
0-20 mA	49 Ω (voltage requirement ≤ 2,5 V)	≤ 0,1 %	≤ 1,5 μA

10 Safety hints



Modified definition according to EN 14597 (former DIN 3440) “Temperature control devices and temperature limiters for heat generating systems”

After introduction of this new standard (2005-12) the definitions described therein were changed again. According to the latest release (EN14597, 2009-1) a temperature limiter TB is no longer considered as operating equipment (as a temperature monitor TW) but as protective equipment (!) which needs to meet higher requirements

The most important requirement for a TB has now been added:
Any device or component must be failsafe and the supply to the plant switched off!

This unit was built and tested in compliance with VDE 0411-1 / EN 61010-1 and was delivered in safe condition.

The unit complies with European guideline 89/336/EWG (EMC) and is provided with CE marking.

The unit was tested before delivery and has passed the tests required by the test schedule. To maintain this condition and to ensure safe operation, the user must follow the hints and warnings given in this operating manual.

The unit is intended exclusively for use as a measurement and control instrument in technical installations.



Warning

If the unit is damaged to an extent that safe operation seems impossible, the unit must not be taken into operation.

ELECTRICAL CONNECTIONS

The electrical wiring must conform to local standards (e.g. VDE 0100). The input measurement and control leads must be kept separate from signal and power supply leads.

In the installation of the controller a switch or a circuit-breaker must be used and signified. The switch or circuit-breaker must be installed near by the controller and the user must have easy access to the controller.

COMMISSIONING

Before instrument switch-on, check that the following information is taken into account:

- Ensure that the supply voltage corresponds to the specifications on the type label.
- All covers required for contact protection must be fitted.

- If the controller is connected with other units in the same signal loop, check that the equipment in the output circuit is not affected before switch-on. If necessary, suitable protective measures must be taken.
- The unit may be operated only in installed condition.
- Before and during operation, the temperature restrictions specified for controller operation must be met.

SHUT-DOWN

For taking the unit out of operation, disconnect it from all voltage sources and protect it against accidental operation.

If the controller is connected with other equipment in the same signal loop, check that other equipment in the output circuit is not affected before switch-off. If necessary, suitable protective measures must be taken.

MAINTENANCE, REPAIR AND MODIFICATION

The units do not need particular maintenance.



Warning

When opening the units, or when removing covers or components, live parts and terminals may be exposed.

Before starting this work, the unit must be disconnected completely.

After completing this work, re-shut the unit and re-fit all covers and components. Check if specifications on the type label must be changed and correct them, if necessary.



Caution

When opening the units, components which are sensitive to electrostatic discharge (ESD) can be exposed. The following work may be done only at workstations with suitable ESD protection.

Modification, maintenance and repair work may be done only by trained and authorized personnel. For this purpose, the PMA service should be contacted.



The cleaning of the front of the controller should be done with a dry or a wetted (spirit, water) kerchief.

10.1 *Resetting to factory setting*

In case of faulty configuration, TB40-1 can be reset to its factory default condition.

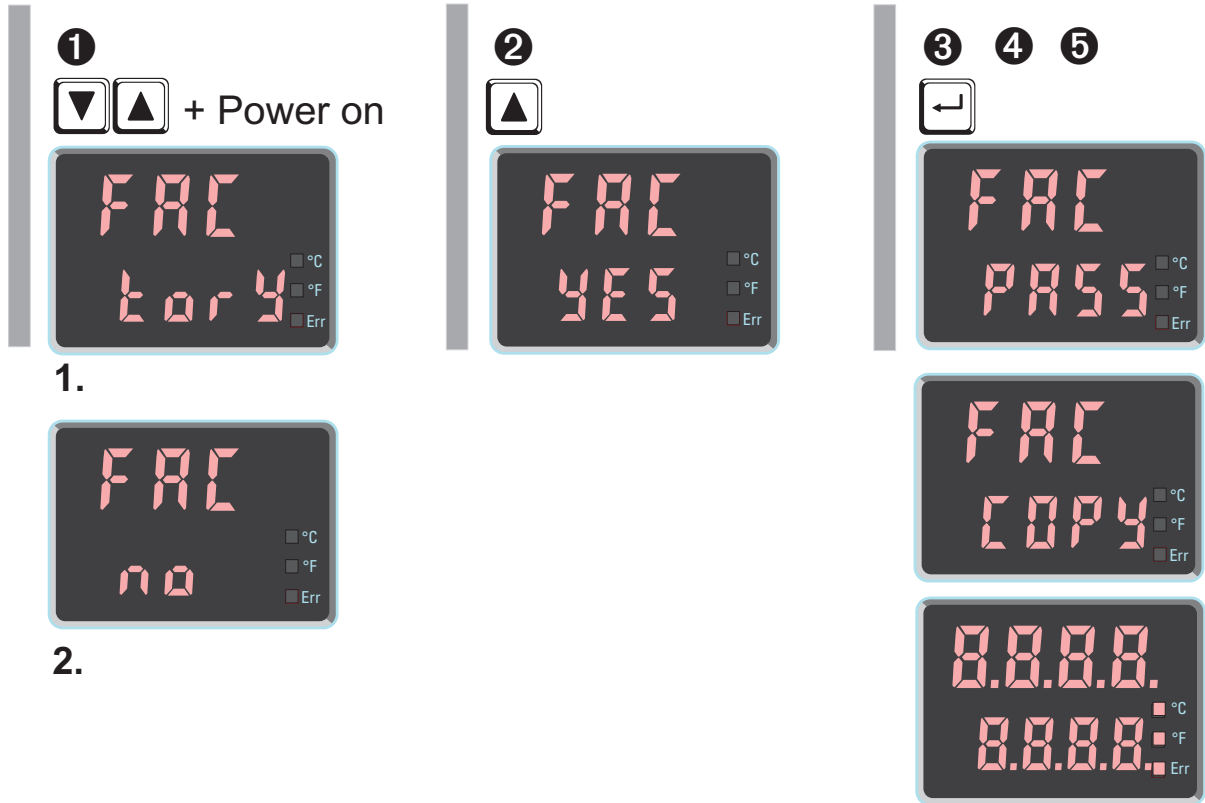

- ❶ For this, the operator must keep the keys increment and decrement pressed during power-on:



- ❷ For confirmation, press key increment to select **YES** .
❸ Press the key enter to go to the password input.
❹ After setting a valid password the factory resetting is confirmed with Enter and the copy procedure is started (display **COPY**).
❺ Afterwards the device restarts.

In all other cases, no reset will occur(timeout abortion).

i If the safety lock is open then factory resetting is not possible.

i The copy procedure (**COPY**) can take some seconds.
Now, the transmitter is in normal operation.

Index

- !
- 2-point correction. 20
- A**
- Accessory equipment. 24
- Additional alarms. 12
- Alarm handling 11 - 12
- B**
- BlueControl. 23
- C**
- Calibration level 20 - 22
- Certifications 26
- Configuration level 14 - 17
- Connecting diagramm 5 - 6
- Connecting example 6
- Current signal measuring range 25
- D**
- Digital input di1
 - Configuration 16
 - Technical data 25
- E**
- Engineering tool 17
- Environmental conditions 26
- Error list 10
- Error status 11
- Extended operating level 9
- F**
- Front view 8
- H**
- Housing. 26
- I**
- Input INP1
 - Configuration 15
 - Parameter setting 18
 - Technical data 25
- Input scaling 19
- L**
- LC alarm 11
- LED
 - °C 8
 - °F 8
 - Err - LED 8
 - LED colours. 8
- M**
- Maintenance manager 10
- Method of operation limit value LC . . . 11
- Mounting. 4
- O**
- Offset correction 20
- Output OUT1
 - Configuration 16
 - Technical data 25
- Output OUT2
 - Configuration 16
 - Technical data 25
- P**
- Parameter setting level 18 - 19
- Power supply 26
- R**
- RESET key. 8
- Resetting to factory setting. 30
- Resistance thermometer measuring range 25
- S**
- Safety hints 28 - 30
- Safety switch. 4
- Setting of limit value LC 9
- T**
- Thermocouple measuring range 25
- V**
- Versions 24
- Voltage signal measuring range 25

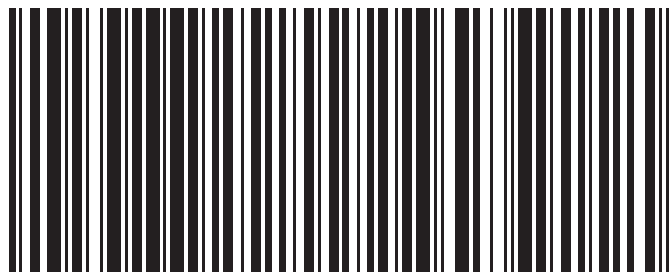

9499-040-93411

A5 auf A6 gefaltet, 2-fach gefaltet, SW-Druck Normalpapier weiß 80g/m²

Subject to alterations without notice
Änderungen vorbehalten
Sous réserve de toutes modifications

© PMA Prozeß- und Maschinen-Automation GmbH
P.O.B. 310 229, D-34058 Kassel, Germany
Printed in Germany 9499-040-93411 (08/2013)

A6