

Product manual 200XLV

INSTALLATION MANUAL CONTENTS

Page 1	General description and specification.
Page 2	Supply details, output current and heatsinking.
Page 3	Set up procedure and customer options.
Page 4	Specification, Block diagram & Mechanical dimensions.
Page 5 & 6	Application diagrams

GENERAL DESCRIPTION

The 200XLV is a small, fast response, linear DC motor speed controller. It can drive brushed DC motors in both directions of rotation with +/- torque. The unit operates from a single polarity supply and has a wide supply range. The supply may be from a battery, or standard unregulated DC rectifier with smoothing capacitor ripple.

Speed regulation is by armature voltage feedback as standard and customer adjustment to compensate for the IR drop is provided. (IR drop is the volt drop across the armature resistance). This method allows low cost applications as no tachometer is required. The unit has +10V and +5V precision references, and +ve and -ve differential speed demand inputs.

The output stage has built in thermal protection and current limit, and a built in automatic re-settable trip provides further protection. Provision is made for a reduced level trip for very low power applications.

The unit is provided with facilities to allow 3 term PID control action. This may be used to implement speed control with tachometer feedback, or position control, eg linear actuators. It is also possible to add a speed demand ramping function if desired.

The thermal dissipation depends on the current and voltage supported by the unit, as with all linear devices this may be high under certain conditions. In the event of thermal power limiting, it may be necessary to increase the effective heatsink. The unit is designed for simple fixing to a metal surface or heatsink.

The extremely compact mechanical design of the 200XLV allows mounting on a back panel or DIN rail, with all connections made via front access plug on screw terminals. Due to the linear operation, the unit is noise free.

SUPPLY DETAILS

The 200XLV may be supplied from a battery source, or AC derived power supply. In general, consideration must be given to the following parameters. (VDD = Vdc supply voltage)

- 1) Minimum V+ for full speed
 - 2) V+ limit to minimise dissipation
 - 3) Maximum allowable V+ of unit
 - 4) Duty cycle of the motor
 - 5) Supply regulation and tolerance
 - 6) Extra V+ to accommodate IR comp
- Power supply formula

$$V_{ac} = 0.7 \times V_{+}, I_{ac} = 1.7 \times I_{dc}$$

$$\text{Transformer VA needed} = V_{ac} \times I_{ac}$$

$$\text{average current per diode} = 0.5 I_{dc}$$

$$\text{Diode reverse volts} = 2 \times V_{ac}$$

The graph shows the DC output of a 60W non-regulated supply. The ripple limits may be reduced with a larger filter capacitor.

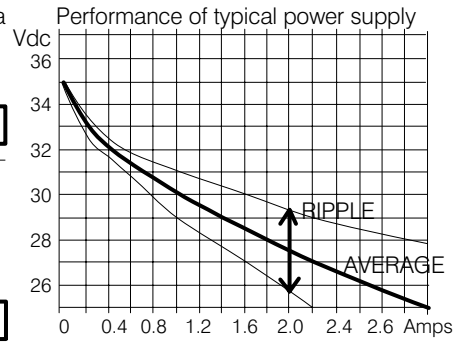
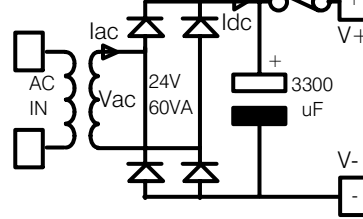

OUTPUT CURRENT and SUPPLY VOLTAGE

The unit will provide up to +/- 2 amps maximum continuous current depending on the armature (AV) and supply voltage (V+). It will need a supply of at least (8V + AVmax) to deliver the full output current. The supply voltage can be 12 to 48V +/- 25%. (absolute maximum 60V dc). The optimum supply is the lowest consistent with correct operation.

The short term current limit overload capability is 150% of the continuous current. eg 2 amps continuous, 3A peak.

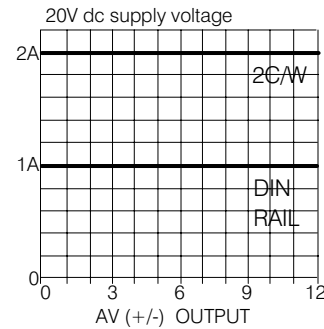
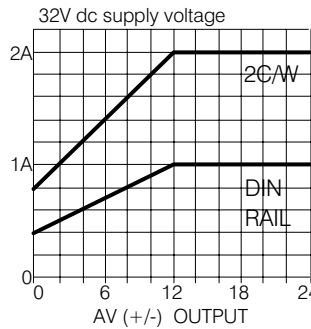
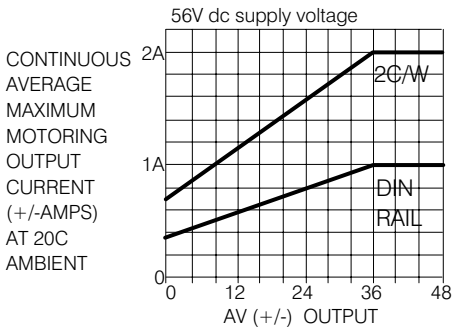

POWER OUTPUT and HEATSINK

The 200XLV has an automatic thermal limiting device. This prevents excess dissipation from damaging the unit. When motoring, the output capability will depend on the dissipation (WD) in the drive. $WD = \text{Amps} \times (V_{+} - AV)$. The maximum dissipation allowed within the 200XLV is 40 watts at a base plate temperature

of 75C. The upper trace in the graphs above show the performance with a 2C/W heatsink. (unit fixed to panel of approximately 200mm X 200mm). The lower trace shows the performance with the unit mounted on a DIN rail.

High dissipation occurs with continuous duty at low speeds, high torques and supply voltage. The worst conditions are during continuous or repetitive braking at high speeds. Fortunately this mode is not often encountered, and most applications will be satisfied with the unit conventionally mounted. In the event that thermal limiting occurs, the unit should be mounted to a larger heatsink with a good thermal connection, and/or the supply to armature voltage differential should be reduced. Forced venting with a small DC fan may be a good solution if space is a constraint.

The typical thermal loads on the unit are listed in the table below. When incorporating the unit for the first time in a machine or system, it must be fully tested at the maximum operating ambient temperature to confirm that the cooling arrangements are adequate. **WARNING.** The unit casing acts as a heatsink and may be too hot to touch.

FUNCTION	DISSIPATION
Continuous braking with motor being overhauled by external force and 200XLV trying to hold it back	Extremely high
Continuous repetitive braking to stop with high inertia loads	Very high
Continuous motoring at low speeds and high torques	Very high
Continuous motoring at medium speeds and high torques	High
Continuous motoring at high speeds and high torques	Quite high
Continuous motoring with light loads and occasional stopping	Medium
Occasional motoring and braking with periods of resting	Low

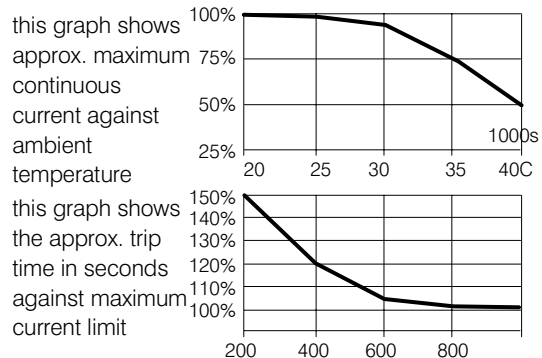

OVERLOAD TRIP

The 200XLV is fitted with an overload inverse time trip device. See graphs above. Excessive overload will trigger the device. The READY lamp will go off. The trip can be reset by removing the power from the unit for a few seconds. If the unit repeatedly trips with no motor connected, then this indicates an internal fault in the unit. Provision is made for an auxiliary device of a lower threshold to be fitted if very small motors are used. See page 3 for fitting details.

SET UP PROCEDURE

- 1)** Check the following prior to applying power to the unit. Supply is rated for maximum armature volts + 8V. Supply is able to deliver the required current. Supply polarity is correct. No damage to personnel or equipment will be caused by incorrect motor rotation.
- 2)** With the armature disconnected and the MAX and IR COMP presets fully anticlockwise, apply the power. Check the READY lamp illuminates. Monitor the output voltage between terminals 8 and 9 with a volt meter whilst rotating the external demand pot fully clockwise. Increase the clockwise rotation of the MAX preset until the volt meter indicates the desired maximum forward armature voltage. Repeat for max reverse speed demand, and confirm max reverse armature voltage. If a stop contact is utilised, check that this reduces the armature voltage to approx. 0V. Set external speed demand to zero. (see PG links below for range change 4-25V or 8-50V).
- 3)** Turn off the supply and reconnect the motor armature. Turn on and slowly increase external demand. Check motor direction rotation is as required. (If not then power off and swap the armature connections). Increase the demand to maximum and confirm motor speed is approximately correct for both directions of rotation. Fine adjust if necessary with the MAX preset.
- 4)** If the speed droops excessively when the motor is loaded, this can be compensated for. Set the unloaded motor to approx. 50% speed, and note this speed. Apply the load, then slowly increase the clockwise rotation of the IR COMP preset to restore the original speed. The motor should now hold the same speed with and without load. Excessive rotation of IR COMP may cause instability. DO NOT allow this to occur, it may lead to damage. The IR COMP system works by adding extra volts to the armature. (Vextra = amps X arm resistance) beware of

OPTIONS

The 200XLV is provided with some extra functions which may require customer added parts.

They are :- 1) PID FEEDBACK FOR POSITION OR TACHO SENSORS 2) SETPOINT RAMP 3) AUXILIARY TRIP

PID FEEDBACK

The input amplifier feedback network can be changed to P or PI or PID mode by the top 3 position jumper. (proportional (P), proportional + integral (PI) or proportional + integral + derivative (PID)). In PI or PID mode the feedback time constant is approximately 100mS and the proportional gain 3. The MAX preset becomes a gain control. The integral time constant can be increased by adding a bipolar capacitor in the INT CAP position. The time constant increases in proportion to the value of the INT CAP. 100nF will add 100mS. The proportional gain can be doubled by breaking the top and bottom PG links.

Set the bottom jumper position to the feedback type. ARMATURE VOLTAGE (AV) or TACHO / POSITION (PID).

Note. For supply voltages > 30V the jumper may have to be parked on one pin for full range operation in (PID) mode.

For speed feedback with tachogenerator use the top jumper in PI mode, or PID mode for extra response. For position feedback use the PID mode. Use a square wave input and oscilloscope to observe the response, use the MAX preset for fine tuning the response. Make sure all feedback transducers are free of backlash. In the event that feedback is lost, the armature voltage will be automatically limited to within a few volts of the supply voltage.

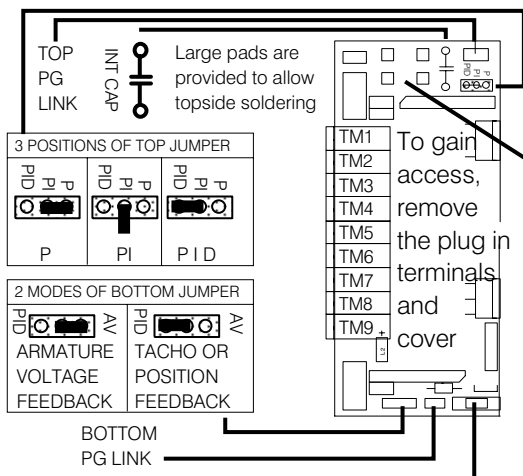

SETPOINT RAMP

Add two 16V electrolytic capacitors in the position provided as per the table. The speed will ramp exponentially to the new value in the time indicated. When power is removed from the unit it will take the same time period for the speed demand to internally reset. Use this feature to limit accel and decel current during reversing.

TIME TO RAMP TO NEW SPEED	2 CAPS VALUE
t = 100mS	1 uF
t = 1 second	10 uF
t = 5 seconds	33 uF
t = 15 seconds	100 uF

PG LINKS

Proportional gain links. With both links made and with AV feedback selected, the range of adjustment of the MAX preset is +/- 4 to +/-25V for a 5V speed demand. Cut both links to allow MAX adjustment from +/-8 to +/-50V.

AUXILIARY TRIP

If a small motor is being used and a lower protection limit is required, a multifuse may be fitted in the FUSE position after the FUSE link has been cut. The table opposite gives BOURNS multi fuse types according to armature current.

MF-R025	250mA	Cut link and add multifuse
MF-R050	500mA	
MF-R075	750mA	
MF-R135	1.35 A	

TYPE 200XLV 4 QUADRANT LINEAR DRIVE

VOLTAGE LIMIT	For DC motors with maximum armature voltage ratings from +/- 6V up to +/-48V
CURRENT LIMIT	0 to +/- 2 Amps continuous, +/- 3 Amps peak
INPUT SUPPLY	12 to 48V DC, +/- 25%. Current = I _{arm} + 100mA
PRESETS	Maximum speed limit IR compensation 0 to 6 Ohms
REFERENCES	Precision current limited voltage references +10V, +5V, 5mA max. both short circuit proof
SPEED INPUTS	Differential inputs. 300K Ohms input impedance. Will accept speed demand inputs +/-5V or +/-10V. Input signal range up to +/-10V outside the supply
CONTROL ACTION	P or P+I or PID, armature, tacho or position feedback
PROTECTION	Thermal protection by automatic power limiting. 150% current limit with inverse time re-settable trip.

BLOCK DIAGRAM

- 1) +10V reference
- 2) -SP inverting speed input
- 3) +SP non-inverting speed input
- 4) +5V reference
- 5) Com. Electronics 0V. Also on T6

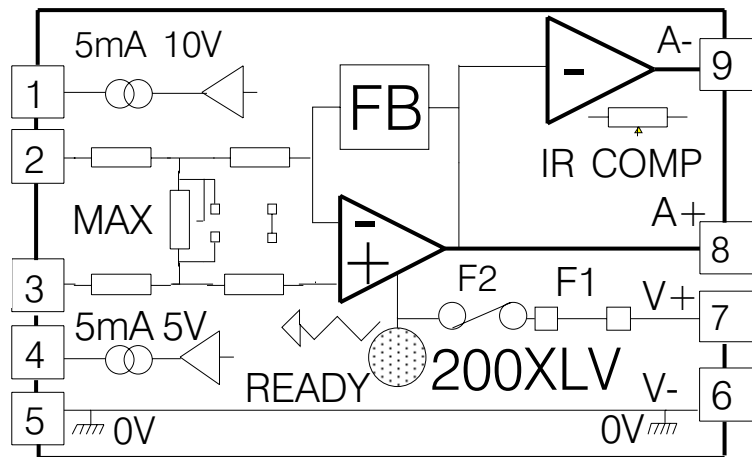

- 6) V-. -ve DC power supply input
- 7) V+. +ve DC power supply input
- 8) A+ Armature connection
- 9) A - Armature connection

Depth is 50mm including plug in terminals

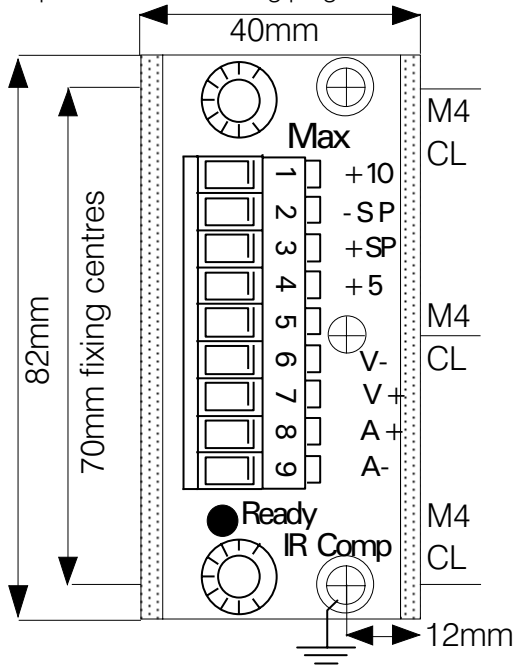

Remove plug on terminals, and plastic cover to gain access to the fixing holes

The heatsink is isolated from the electronics. If earthing is required then use a ring terminal on the lower fixing.

The unit may be mounted on a flat metal panel to improve the thermal performance. There is a centre hole for a DIN rail fixing bracket if required. (part no.FE101969)

Important notes on using the 200XLV

- 1) The maximum voltage allowed between the isolated heatsink and the drive V- supply on terminal 6 is 50V RMS.
- 2) For optimum thermal connection to a back panel make sure it is flat, and that both mating surfaces are in good thermal contact.
- 3) The DC supply should be connected via a 3 AMP fuse.
- 4) The 200XLV is capable of a very fast response to step demand changes. Use the SETPOINT RAMP facility to limit the motor slew rate if rapid speed changes or high peak current is undesirable.

FORWARD /STOP/REVERSE BY CENTRE ZERO

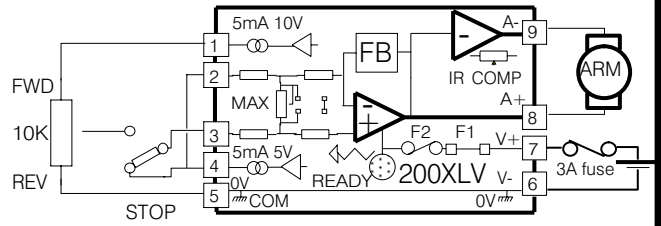

FORWARD/STOP/REVERSE BY SWITCH

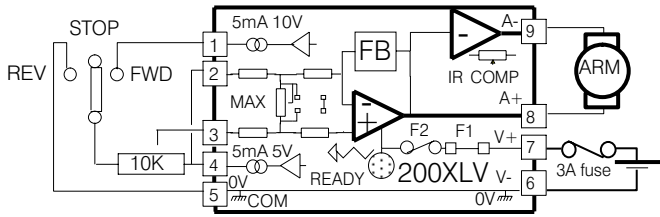

0 TO +/-5V OR +/-10V SPEED SIGNAL

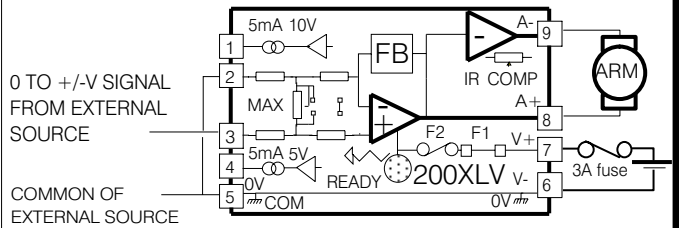

0 TO +/-V (V > 10V) SIGNAL FROM EXTERNAL SOURCE

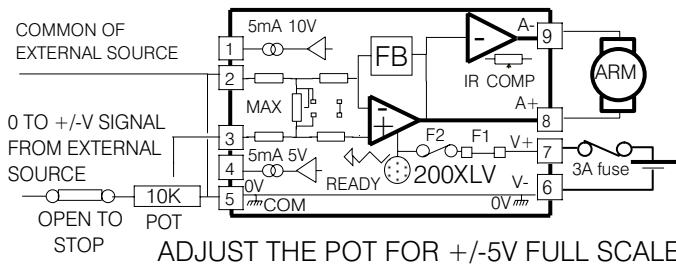

0 TO +V SIGNAL WITH DIRECTION CHANGE SWITCH

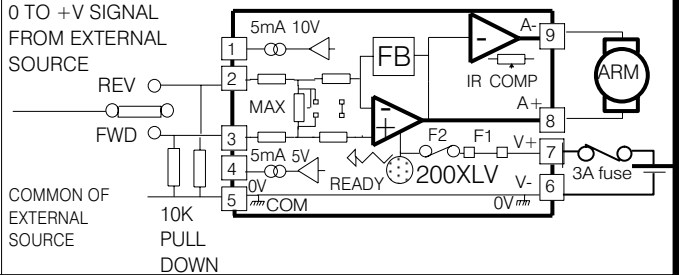

TORQUE CONTROLLER 200XLV

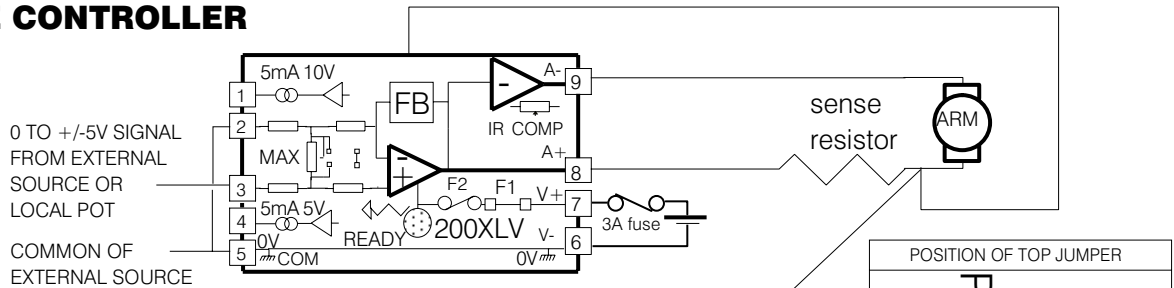

TO USE THE 200XLV AS A TORQUE (CURRENT) CONTROLLER
 A sense resistor is inserted in the A+ output terminal 8. A sense signal is taken from the resistor to the AV pin on the bottom jumper pins. Remove the bottom jumper. The unit will now output current in proportion to input voltage.

The scaling is set by the sense resistor according to the table with the MAX preset fully anticlockwise. The MAX preset may be used for fine adjustment of the scaling factor.

input signal	sense resistor		output current
+/-5V	1 Ohm	6 watts	+/- 2 amps
+/-5V	2 Ohm	3 watts	+/- 1 amp
+/-5V	4 Ohm	1.5 watts	+/- 0.5 amp
+/-5V	10 Ohm	1 watt	+/- 0.2 amp

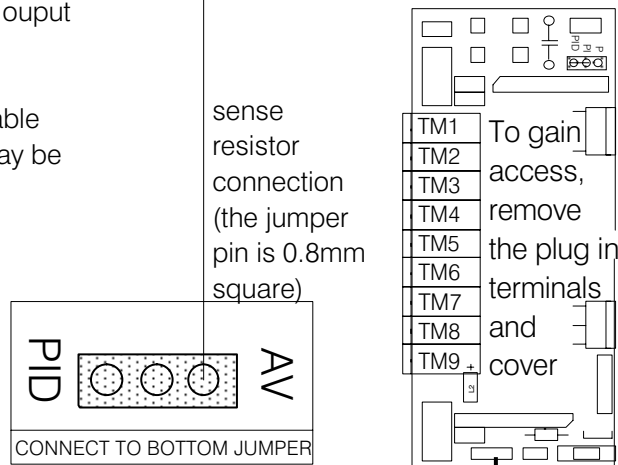

Important notes on using the 200XLV

THESE DIAGRAMS SHOW BASIC CONNECTIONS EMPLOYING AN EXTERNAL ZERO OFFSET POT
The output voltage can be adjusted to a precise zero.
The zero drift over the entire temperature range is less than +/-100mV, this is normally less than the motor starting voltage.

FORWARD /STOP/REVERSE BY CENTRE ZERO

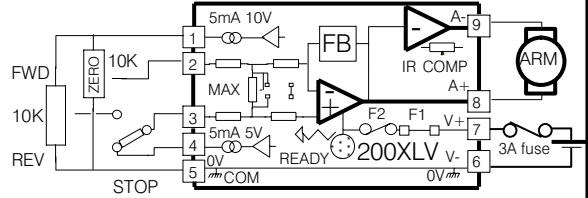

FORWARD/STOP/REVERSE BY SWITCH

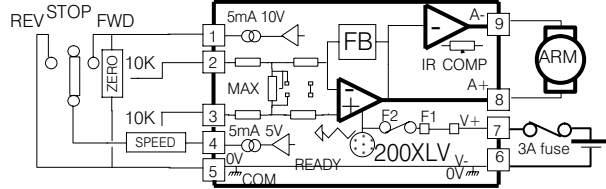

0 TO +/-5V OR +/-10V SPEED SIGNAL

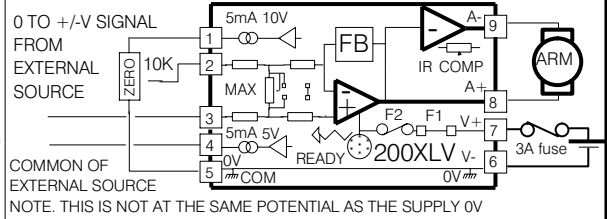

0 TO +/-V (V > 10V) SIGNAL FROM EXTERNAL SOURCE

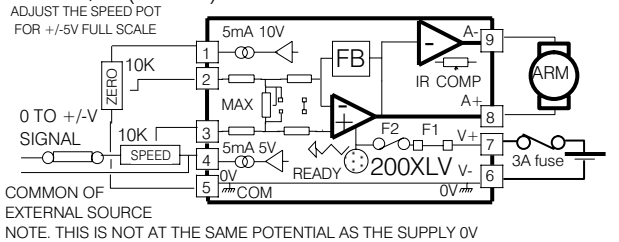

0 TO +V SIGNAL WITH DIRECTION CHANGE SWITCH

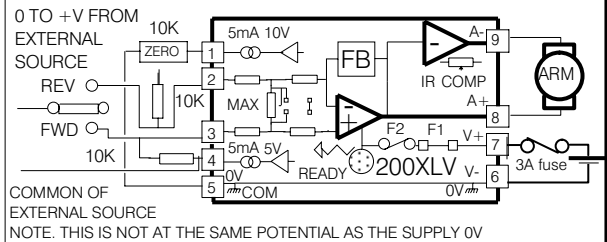

UNREGULATED POWER SUPPLY DC = 1.4 X AC SUPPLY
(MAKE DC SUPPLY AV MAX + 8V) 3A FUSE

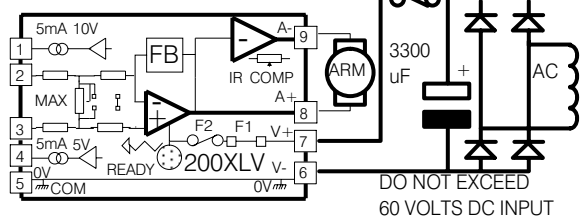

TACHO FEEDBACK WITH UNIT IN P+I MODE

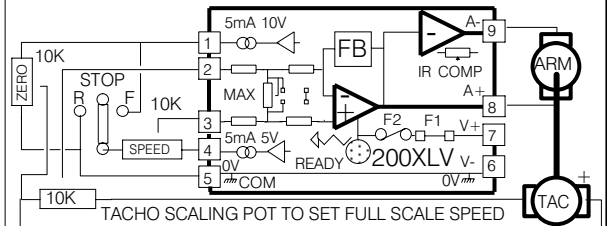

POSITION AND SPEED FEEDBACK IN PID MODE

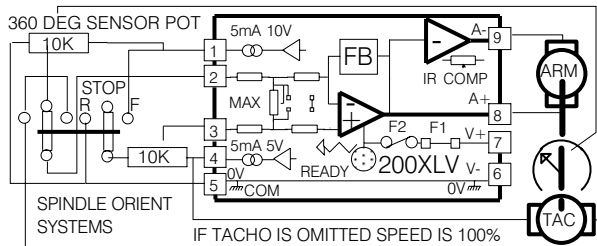

POSITION FEEDBACK WITH UNIT IN PID MODE

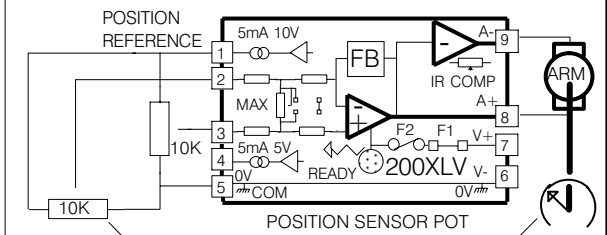

POSITION FEEDBACK WITH END OF TRAVEL LIMIT

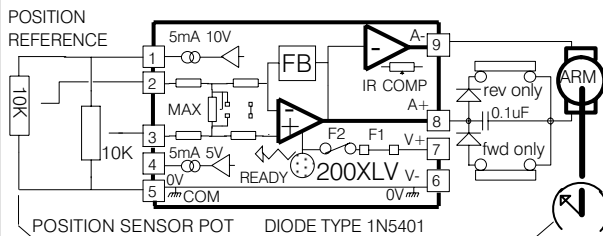

SPRINT ELECTRIC LTD. DOES NOT ACCEPT ANY LIABILITY WHATSOEVER FOR THE INSTALLATION, FITNESS FOR PURPOSE OR APPLICATION OF ITS PRODUCTS. IT IS THE USERS RESPONSIBILITY TO ENSURE THE UNIT IS CORRECTLY USED AND INSTALLED.

HEALTH AND SAFETY AT WORK. ELECTRICAL DEVICES CONSTITUTE A SAFETY HAZARD. IT IS THE RESPONSIBILITY OF THE USER TO ENSURE COMPLIANCE WITH ANY ACTS OR BYLAWS IN FORCE. ONLY SKILLED PERSONS SHOULD INSTALL THIS EQUIPMENT.

WARNING



ELECTRIC SHOCK RISK



Sprint Electric Limited

Ford, Arundel, West Sussex email info@sprint-electric.com
UK, www.sprint-electric.com