



INSTALLATION MANUAL

Manual Brel Bi-directional Wifi Curtain Rail Motor

BG-980

Read the manual before you begin the installation. If these instructions are not followed, this may lead to defects and injury in which warranty can't be claimed.



BREL HOME

www.brel-home.com

Visit our website for more manuals and information



BG-980

Scan the QR code here for the manual to
download & view instructional videos

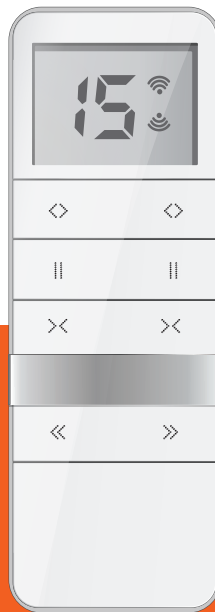

Table of Content

Warning	2
Switching installation of the curtain motor	3
Works with all BREL transmitters	3
Technical data of the motor	3
Functions remote control/Function/ Installation of the Motor	4
Settings	5

Warning

It is important to follow this instruction for your own safety.



Do not operate the motor in humid surroundings.



BREL-Motors declares that this motor has been manufactured according to the guidelines of the CE standard 1999/5/EC



The motor must be protected from direct moisture influences.



Keep the antenna in a good condition and do not shorten. The antenna should not come into contact with other metal parts otherwise it will reduce the effect.



The motor must be installed correctly.



This product must not be disposed of with household waste. Take the remote control and battery to the designated collection points"



Children cannot recognize the dangers of electrical equipment and may therefore not work with it.

Switching installation of the curtain motor

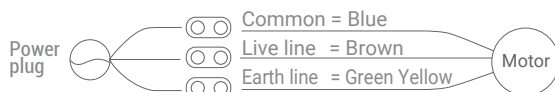
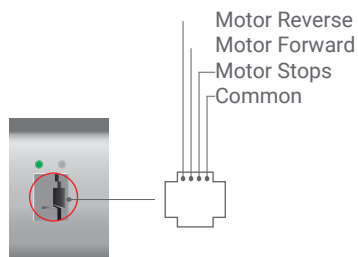
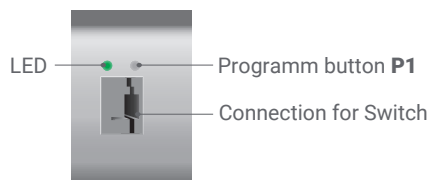

Works with the BREL HOME app

You just need to download our BREL HOME app to operate the motor with your mobile/cell phone.

As it is a wifi motor it can be connected to BREL HOME app without using a hub.

You connect the motor via the app on your home Wifi network and you can install the motor as described in the app.

If you want to install the motor by emitter, you have to follow the steps in this manual.

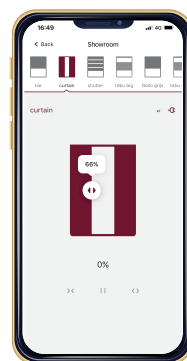

Technical data of the motor

BG-980

Torque	1.2 nm
Open/Close Speed	14 cm per sec.
Voltage Motor	AC 100-240V
Max. Curtain Weight	40 kg
Radiofrequency	433.925MHz
Moisture and Dust Protection	IP20
Storage Capacity Transmitters	Up to 20 Channels
Temperature range of the motor	Normal Use : -5°C to +55°C
Frequency	433Mhz 2.4Ghz (wifi)



Functions Remote control

DD-1852

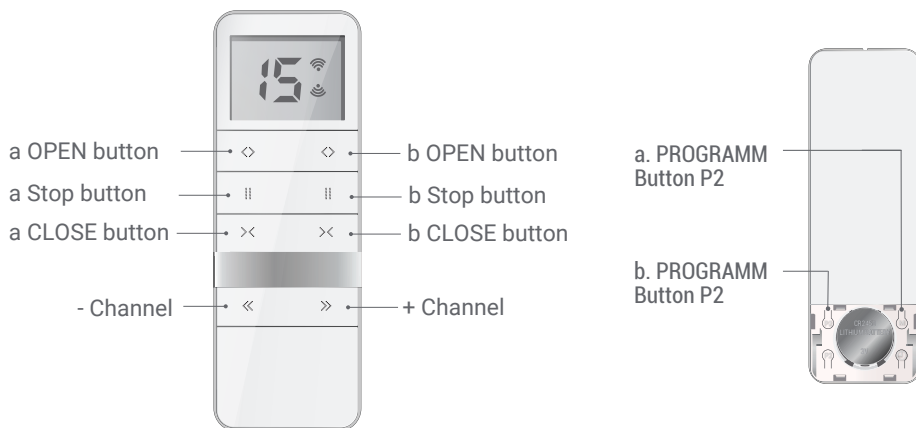

Scan the QR code to view the manual and instructional videos

BG980

Reach

L1 = 100 meter

L2 = 20 meter

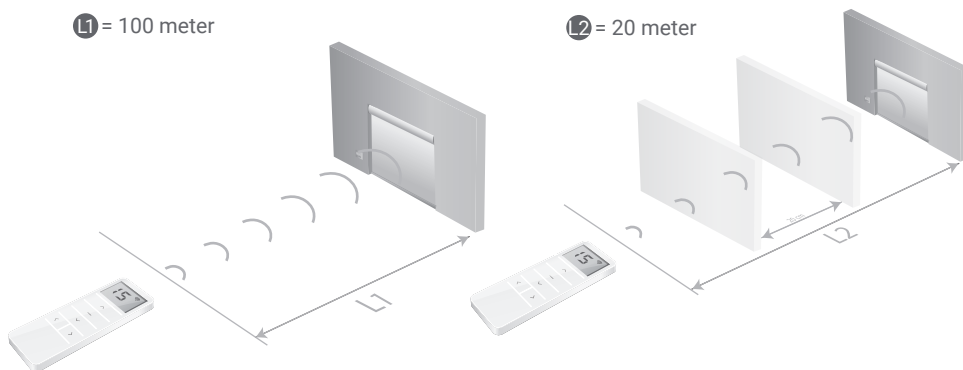



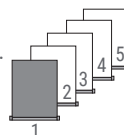

Step 1 Setting up the first remote/channel

- i** The remote control can transmit 15 channels and therefore control multiple blinds. First, select a channel for operating the relevant roller blind. Make sure that you select a free channel (we recommend only 1 product per channel).
- i** This remote has also channel 0. All blinds programmed in channel 1~15 are automatically programmed in this channel 0 and can be operated all at once.
- i** In case you have selected the wrong channel, go to **Resetting factory settings**.



► **Select the desired channel.**

Step 2 Establishing connection

-  In the procedures described here is a maximum interval of 10 seconds to complete each subsequent action: if you wait any longer, the system will leave the edit mode.
-  Normally a button only needs to be pressed shortly. If you need to press and hold a button for several seconds this will be state clearly.
-  The system will confirm each completed step with moving the blind up and down (⚡).
-  If a procedure does not play out as described, wait for 20 seconds and start again from the beginning of that step/procedure.



-  If NO end positions are set, the product will move in the pulse / step operation. Go then to STEP 3. If end positions are set, the product will continue to its end position. Go then to STEP 5.
WARNING: It is possible that the correct end positions have not been set. Go then to OPTION A.

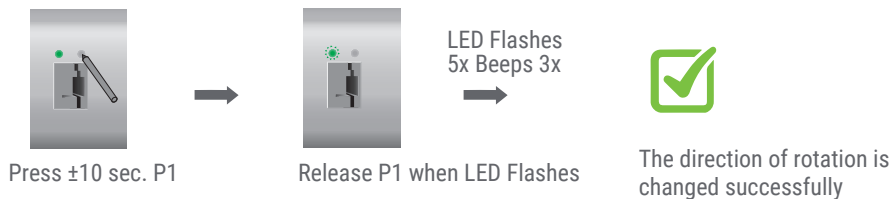

Step 3 Adjusting the direction of rotation *(Only if the direction of rotation is not correct)*

Only possible if no end positions are set.

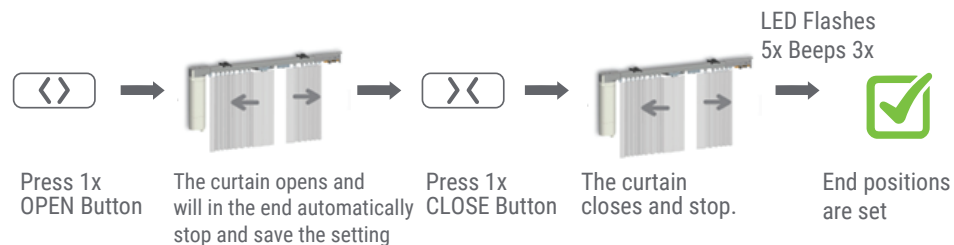

Step 4 Setting the End Limits



-  **The curtains are now ready for use.**
-  If you are not satisfied with the result of setting the end positions, go to Option A - adjusting positions or **Resetting factory settings.**

Step 5 Setting the favorite position (If desired)

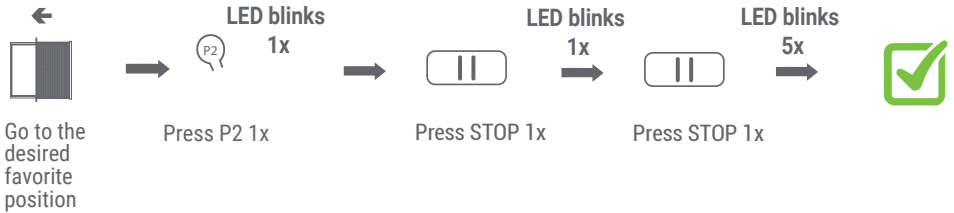

i Press and hold STOP for 3 seconds to move to the favorite position.

i Since the procedure is identical, to remove it repeat the steps.

Additional settings

Option A Adjusting the open position

i If adjustment is not possible, go to **Resetting factory settings**.

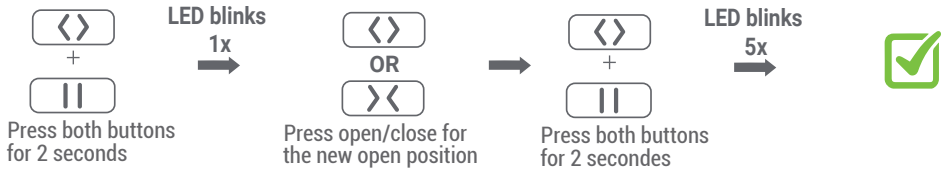

Adjusting the close position

i If adjustment is not possible, go to **Resetting factory settings**.

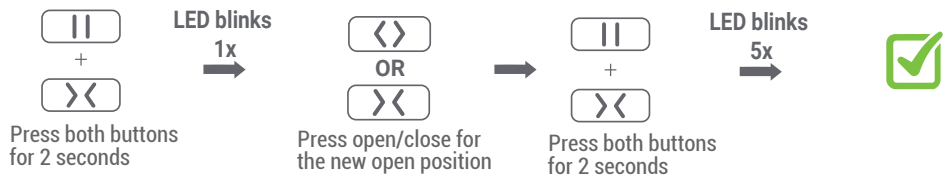

Option B Learn Extra transmitter/channel

i Make sure the new transmitter is in the desired channel.

a = Already existing transmitter/channel

b = New transmitter/channel

NOTE To delete the transmitter / channel repeat the procedure.

Method 1

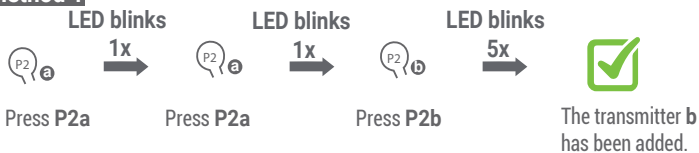

Method 2 (In case the old transmitter is lost or broken)



Option C Speed Control

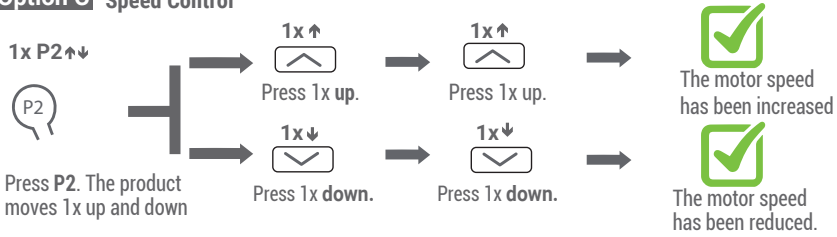

- (i)** If the motor does NOT react after this action, it is already at the highest or lowest speed.
- (i)** There are 3 different speeds.
- (i)** If the speed has been changed the slow stop is activated. To deactivate the slow stop you have to reset the motor.

External Switch Mode Pushbutton switch mode (Factory default)

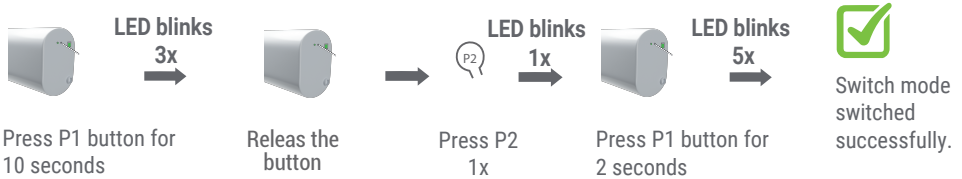

Mechanical switch mode

Check both upper and lower limits are set, the motor is power-on (1 jog), within 10S.

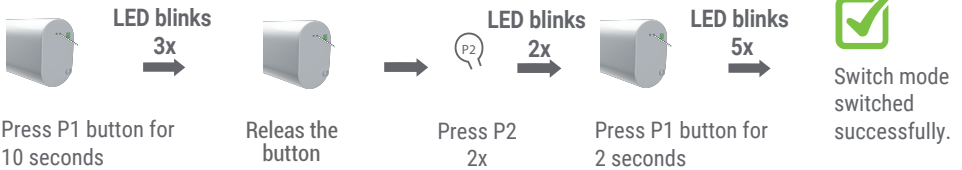

Electronic switch mode

Check both upper and lower limits are set, the motor is power-on (1 jog), within 10S.

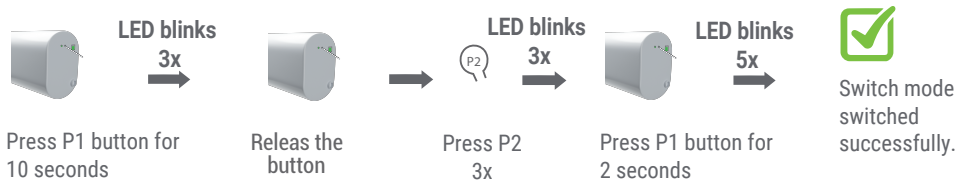

Single button pushbutton switch mode

Check both upper and lower limits are set, the motor is power-on (1 jog), within 10S.

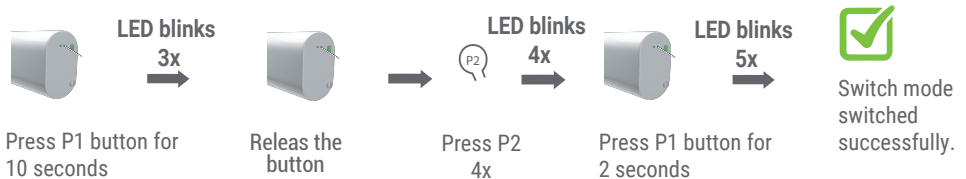

Additional settings P1 button Can be used without a transmitter as an operating button.



The LED light blinks when pressed P1

Manual control



Press the P1 button for 10s

Release the button

Press the STOP button

Manual control has been (de) activated.

Switching off the receiver



Press and hold P1 until the LED light blinks 2x.

The Receiver switched off.

To reactivate the receiver, briefly press P1 once.

Changing the direction of rotation

Method 1 (with end limits)



Press and hold P1 for 10s

Loosen button

Press 1 second

The direction of rotation has changed.

Method 2 (without end limits)



Press both buttons for 2 sec

The direction of rotation has changed.

Resetting to factory settings



Press the P1 button for 14 seconds

Release the P1 button

Resets to factory settings.

! To apply new settings: go to step 1

Changing Batteries





INSTALLATIE HANDLEIDING

Handleiding voor bi-directionele gordijnmotor met Wifi

BG-980

Lees de handleiding alvorens u begint met de installatie. Als de instructies niet worden opgevolgd kan dit leiden tot defecten welke niet onder garantie kunnen worden geclaimd.



www.brel-home.com

Bezoek onze website voor meer informatie



BG-980

Scan de QR-code om de handleiding en instructie video's te bekijken



Inhoudsopgave

Waarschuwingen	2
Bekabeling/motorinstallatie en compatible met hub	3
Technische gegevens/bereik/opladen van de motor	4
Functies afstandbediening	5
Instellingen	5

⚠ Waarschuwing



Plaats de motor niet in een vochtige omgeving



De motor moet beschermd worden tegen water en andere vochtige invloeden



De motor moet correct worden geïnstalleerd



Brel Motors verklaart dat de motor is gefabriceerd volgens de CE standaard 1999/5/EC norm



De antenne moet in goede conditie verkeren. Kort deze niet in. Zorg ervoor dat de antenne niet in contact komt met andere metalen. Indien dit toch gebeurt zal dit de functie beïnvloeden



Sta niet toe dat kinderen met de bedieningsapparatuur van het rolgordijn spelen. Houd afstandsbedieningen buiten bereik van kinderen. Kinderen kunnen het gevaar niet herkennen van de elektronische apparaten en mogen er daarom niet mee werken

Bewaar deze handleiding zodat u in de toekomst deze kunt raadplegen.

Installatie van de gordijnmotor

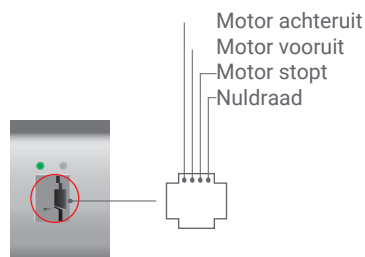
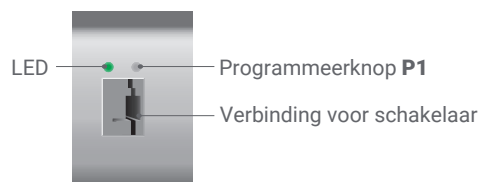

Werkt met de BREL HOME app

U hoeft alleen maar onze BREL HOME-app te downloaden om de motor te bedienen met uw telefoon.

Omdat het een wifi-motor is, kan deze worden verbonden met de BREL HOME-app zonder een hub te gebruiken.

Je koppelt de motor via de app aan uw wifi-thuisnetwerk en installeert de motor zoals beschreven in de app.

Als u de motor per zender wilt installeren, dient u de stappen in deze handleiding te volgen.

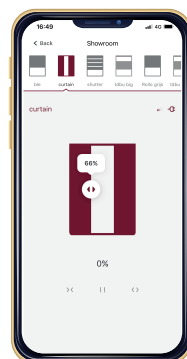

Technische data van de motor

BG-980

Draaimoment	1.2 nm
Open/dicht snelheid	14 cm per sec.
Voltage	AC 100-240V
Max. gewicht gordijn	40 kg
Frequentie	433.925MHz
Vocht- en stofwerendheid	IP20
Opslag	Up to 20 Channels
Werktemperatuur van de motor	Normaal gebruik : -5°C to +55°C
Frequentie	433Mhz 2.4Ghz (wifi)



Funcies Afstandsbediening

DD-1852

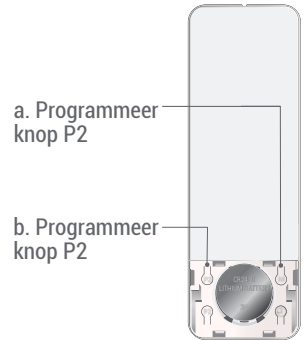
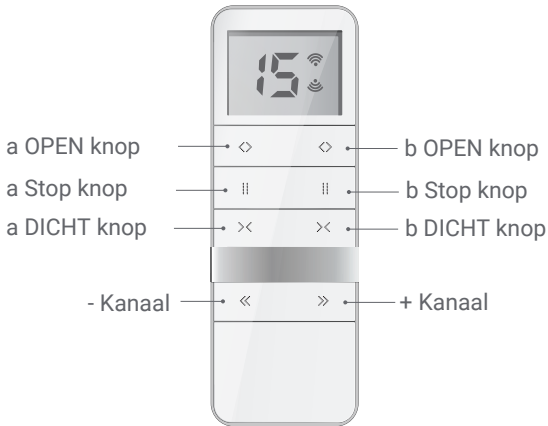

Scan de QR code voor de handleiding en instructie video's

BG980

Bereik

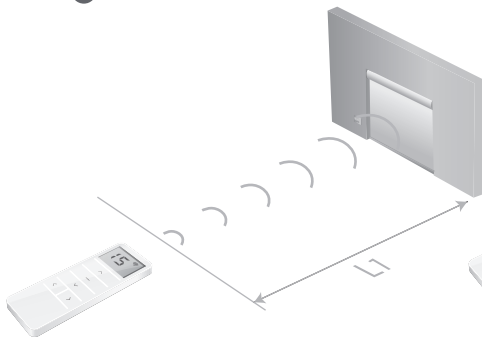

Ⓛ₁ = 100 meter

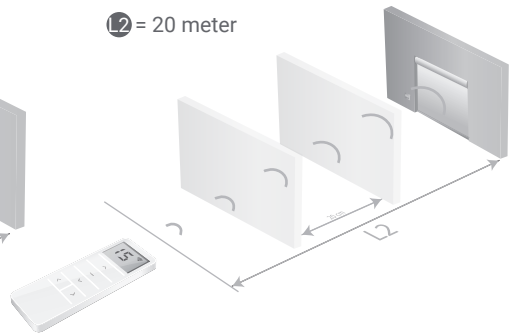

Ⓛ₂ = 20 meter





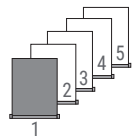

Stap 1 Het programmeren van de eerste afstandsbediening/kanaal

-  De afstandsbediening kan op 15 kanalen uitzenden en dus ook meerdere motoren aansturen. Kies daarom eerst het gewenste kanaal bij het desbetreffende product/motor. Kies een vrij kanaal. Wij adviseren 1 motor per kanaal.
-  De afstandsbediening heeft een kanaal 0. Alle motoren die op kanaal 1-15 zijn geprogrammeerd staan automatisch op kanaal 0.
-  Wanneer achteraf blijkt dat u bij een product het verkeerde kanaal hebt geprogrammeerd, ga dan naar **Resetten naar fabrieksinstellingen**.



► **Selecteer het gewenste kanaal**

Stap 2 Verbinding tot stand brengen

-  Indien u niet binnen 10 seconden begint met programmeren dan zal de motor uit de programmeer modus gaan.
-  Tijdens het programmeren dient u de toets kort in te drukken. Indien u deze lang dient vast te houden staat dit vermeld
-  De motor bevestigt iedere afgeronde stap met een op en neer beweging (↕).
-  Als een procedure niet gaat zoals gepland, wacht dan 20 seconden en begin dan opnieuw.



-  Als er GEEN eindposities zijn ingesteld dan zal de motor in de puls mode bewegen. Ga dan naar stap 3.
- Als er eindposities zijn ingesteld controleer dan de eindposities. Indien juist ga dan naar stap 5.
- Waarschuwing: Als de eindposities niet goed zijn ga dan naar optie A

Stap 3 De draairichting aanpassen

(Alleen als de draairichting niet correct is)

Alleen mogelijk als er geen eindposities zijn ingesteld.

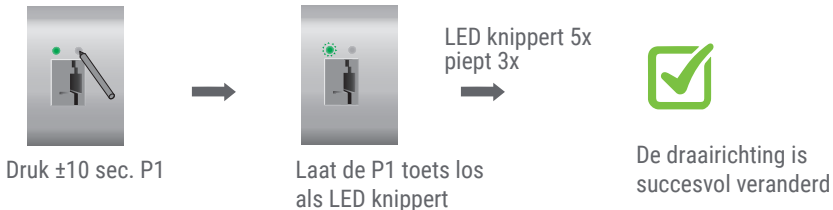

Stap 4 Eindposities instellen

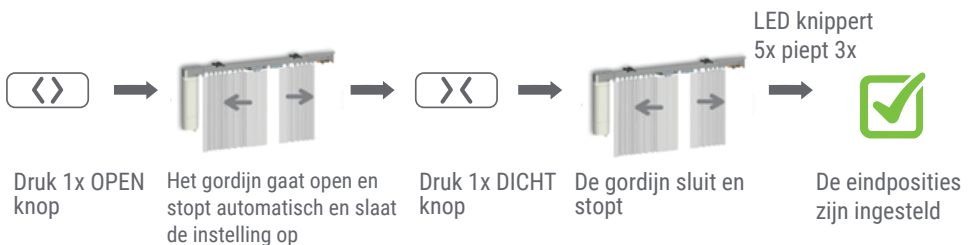

-  De gordijnen zijn nu klaar voor gebruik.
-  Bent u niet tevreden met het resultaat van het instellen van de eindposities, ga dan naar Optie A - Posities aanpassen of Fabrieksinstellingen terugzetten.

Stap 5 Favoriete positie instellen (Indien gewenst)

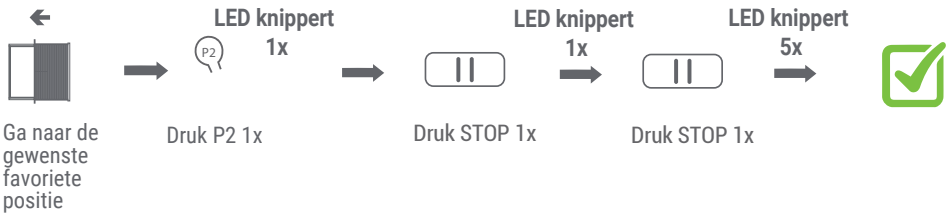

i Houd STOP 3 seconden ingedrukt om naar de favoriete positie te gaan.

i Aangezien de procedure identiek is, herhaalt u de stappen om deze te verwijderen.

Extra instellingen

Optie A De open positie aanpassen

i Als aanpassing niet mogelijk is, ga dan naar Fabrieksinstellingen terugzetten.

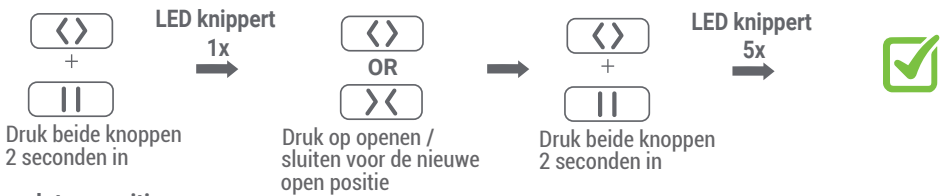

De gesloten positie aanpassen

i Als aanpassing niet mogelijk is, ga dan naar Fabrieksinstellingen terugzetten.

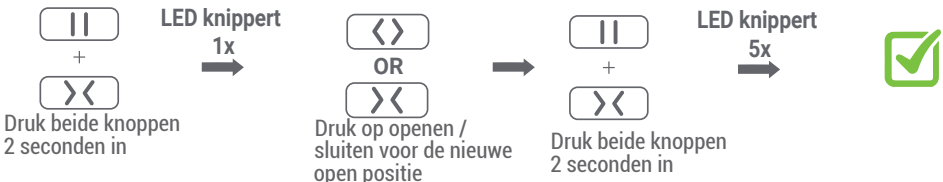

Optie B Inlezen Extra zender / kanaal

i Zorg ervoor dat de nieuwe zender zich in het gewenste kanaal bevindt.

a = Reeds bestaande zender / kanaal

b = Nieuwe zender / kanaal

NOTE Herhaal de procedure om de zender / het kanaal te verwijderen.

Methode 1



Methode 2 (In case the old transmitter is lost or broken)



Optie C Snelheids regeling

- Als de motor niet reageert na deze actie dan is hij al in de hoogste of laagste snelheid.
- Er zijn 3 verschillende snelheden.
- Als de snelheid is veranderd dan word de functie soft-stop geactiveerd. Om dit te deactiveren moet de motor gereset worden.

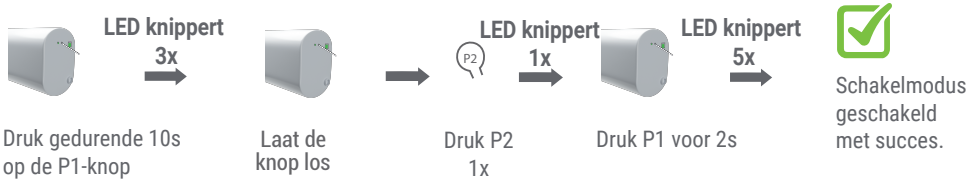
Externe schakelmodus Drukknopschakelmodus (fabrieksinstelling)**Mechanische schakelmodus**

Controleer of zowel de boven- als de ondergrens zijn ingesteld, of de motor is ingeschakeld (1 jog), binnen 10 sec.

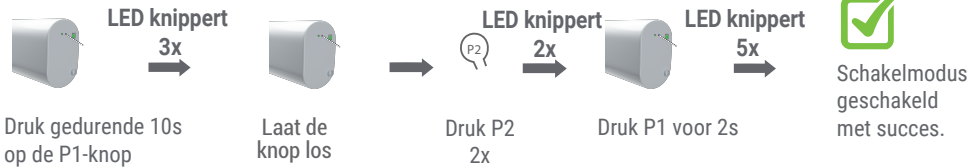
**Electronische schakelmodus**

Controleer of zowel de boven- als de ondergrens zijn ingesteld, of de motor is ingeschakeld (1 jog), binnen 10 sec.

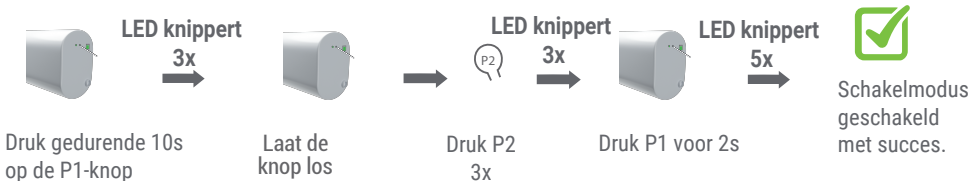
**Schakelmodus met één knop met drukknop**

Controleer of zowel de boven- als de ondergrens zijn ingesteld, of de motor is ingeschakeld (1 jog), binnen 10 sec.

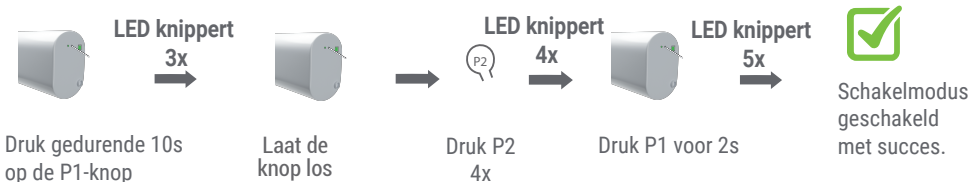

Functies van de P1 toets

kan worden gebruikt als bedieningsknop in geval van nood

**Druk 1 keer kort op de P1 toets****Handbediening**

LED knippert

3x



STOP



LED knippert

5x



Houdt de P1 toets voor 10s ingedrukt

Laat de knop los

Druk op de STOP toets

Handbediening is ge(de)activeerd

Uitschakelen ontvanger

Totdat



Houdt de P1 toets vast tot de motor voor de 2de keer op/naer bewogen heeft. Om de ontvanger weer te activeren druk 1 keer kort op de P1

De ontvanger is uitgeschakeld

Wisselen van draairichting**Methode 1 (met eindpositie)**

LED knippert

3x



LED knippert

5x



Druk P1 voor 10s

Laat de knop los

Druk DICHT voor 2s

De draairichting is omgedraaid

Methods 2 (zonder eindpositie)

LED knippert

5x



+



Druk beide toetsen in voor 2 sec

De draairichting is omgedraaid

Resetten naar fabrieksinstellingen

LED knippert 8x



Druk de P1 toets in voor 14s

Laat de P1 toets los

Reset naar fabrieksinstellingen

📌 Om nieuwe instellingen toe te passen: ga naar stap 1**Batterij vervangen**

Brel Nederland B.V. is geregistreerd volgens de richtlijnen van normering 2012/19/EU inzake batterijen en accu's (de batterijrichtlijn) in het VattG van Nederland. De verplichtingen worden gedekt door deelname aan het collectieve systeem. Brel Nederland B.V. is ingeschreven in het register van We Cycle nrCO00010881 en het Stibat nr. 40350. Voor België Bebat nr 522210 en Recupel nr 940883.





BEDIENUNGS ANLEITUNG

Manueller bidirektionaler Wifi-Vorhangschienenmotor von Brel

BG-980

Lesen Sie das Handbuch, bevor Sie mit der Installation beginnen. Wenn diese Anweisungen nicht befolgt werden, kann dies zu Mängeln und Verletzungen führen, für die keine Garantie geltend gemacht werden kann.



BREL HOME

www.brel-home.com

Besuch unsere Website für Handbücher und Informationen



BG-980

Scannen Sie hier den QR-Code für das Handbuch zu Anleitungsvideos herunterladen und anzeigen



Inhaltsverzeichnis

Sicherheitshinweise	2
Anschluss Motor / Montage Motor / Kompatibilität	3
Technische Daten Motor / Reichweite / Aufladen des Motors	4
Funktionen der Fernbedienung	5
Bedienung und Einstellungen	5

! Sicherheitshinweise



Verwenden Sie den Motor nicht in feuchter Umgebung.



BREL-Motors erklärt hiermit, dass dieser Motor nach den Richtlinien der CE-Norm 1999/5/EG hergestellt wurde



Der Motor muss vor direkter Feuchtigkeit geschützt werden.



Halten Sie die Antenne in gutem Zustand und verkürzen Sie diese nicht! Die Antenne darf nicht mit anderen Antennen oder Metallteilen in Berührung kommen, da ansonsten der Betrieb eingeschränkt wird.



Der Motor muss korrekt installiert sein.



Lassen Sie Kinder nicht mit dem Rollo und/oder der Fernbedienung spielen. Halten Sie die Geräte ausserhalb der Reichweite von Kindern. Kinder können die Gefahren elektrischer und elektronischer Geräte nicht erkennen.

Die Anleitung für zukünftiges Nachschlagen aufbewahren.

Schaltanlage des Behangmotors

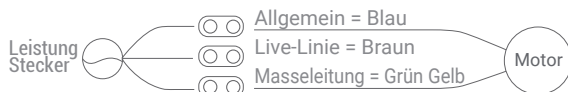
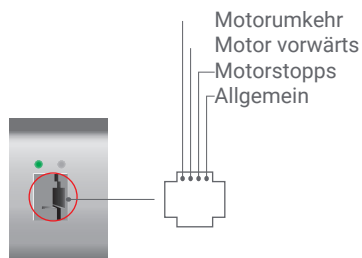
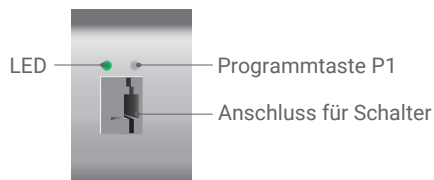

Funktioniert mit der BREL HOME-App

Sie müssen nur unsere BREL HOME App herunterladen, um den Motor mit Ihrem Handy/Handy zu bedienen.

Da es sich um einen WLAN-Motor handelt, kann er ohne Verwendung eines Hubs mit der BREL HOME-App verbunden werden.

Sie verbinden den Motor über die App mit Ihrem WLAN-Heimnetzwerk und können den Motor wie in der App beschrieben installieren.

Wenn Sie den Motor per Emitter installieren möchten, müssen Sie die Schritte in dieser Anleitung befolgen.

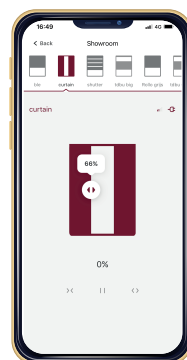

Technische Daten des Motors

BG-980

Drehmoment	1.2 nm
Öffnen/Schließen Geschwindigkeit	14 cm per sec.
Spannung Motor	AC 100-240V
max. Vorhanggewicht	40 kg
Radiofrequenz	433.925MHz
Feuchtigkeits- und Staubschutz	IP20
Speicherkapazität-Transmitter	Bis zu 20 Kanäle
Temperaturbereich des Motors	Normal Betrieb : -5°C to +55°C
Frequenz	433Mhz 2.4Ghz (wifi)



Funktionen Fernbedienung

DD-1852

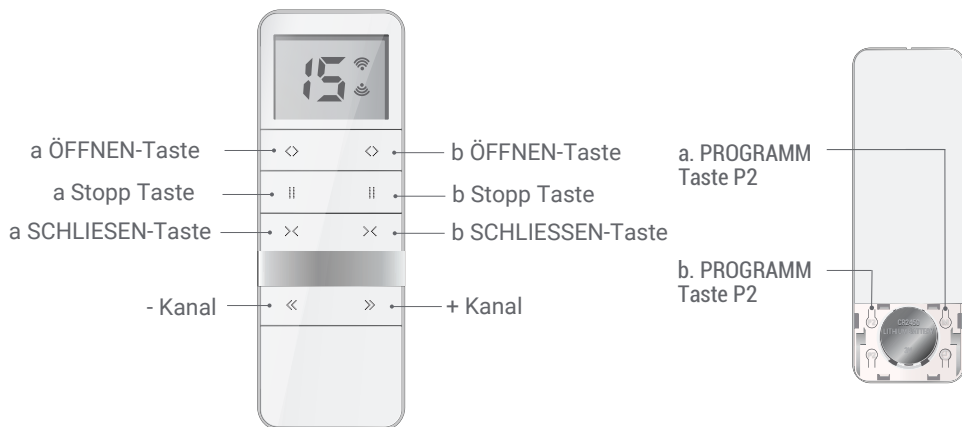

BG980

Scannen Sie den QR-Code, um das Handbuch und die Anleitungsvideos anzuzeigen

Bereich

Ⓛ1 = 100 meter

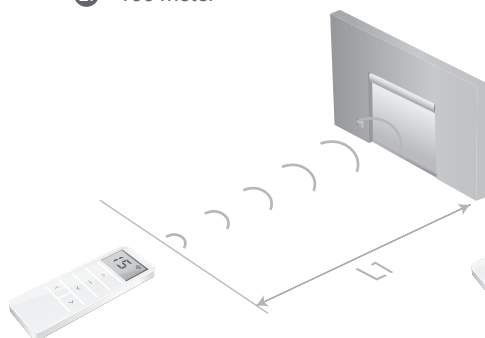

Ⓛ2 = 20 meter

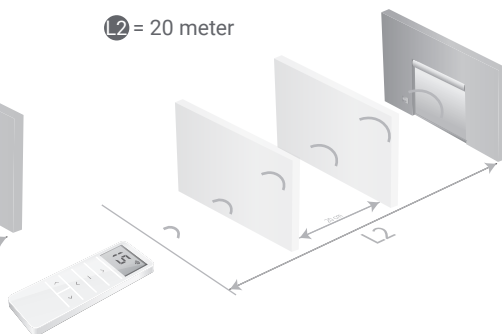



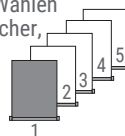

Schritt 1 Einrichten der ersten Fernbedienung/des ersten Kanals

- i** Die Fernbedienung kann 15 Kanäle übertragen und somit mehrere Jalousien steuern. Wählen Sie zunächst einen Kanal zur Bedienung des entsprechenden Rollos aus. Stellen Sie sicher, dass Sie einen kostenlosen Kanal auswählen (wir empfehlen nur 1 Produkt pro Kanal).
- i** Diese Fernbedienung hat auch Kanal 0. Alle in Kanal 1~15 programmierten Jalousien werden automatisch in diesen Kanal 0 programmiert und können auf einmal bedient werden.
- i** Falls Sie den falschen Kanal ausgewählt haben, gehen Sie zu Werkseinstellungen zurücksetzen.



► Wählen Sie den gewünschten Kanal aus.

Schritt 2 Verbindung machen

-  Bei den hier beschriebenen Verfahren gilt ein maximales Intervall von 10 Sekunden für jede nachfolgende Aktion: Wenn Sie länger warten, verlässt das System den Bearbeitungsmodus.
-  Normalerweise muss eine Taste nur kurz gedrückt werden. Wenn Sie eine Taste mehrere Sekunden lang gedrückt halten müssen, wird dies deutlich angezeigt.
-  Das System bestätigt jeden abgeschlossenen Schritt durch Auf- und Abfahren (†).
-  Wenn ein Vorgang nicht wie beschrieben abläuft, warten Sie 20 Sekunden und beginnen Sie von vorne mit diesem Schritt/Vorgang.

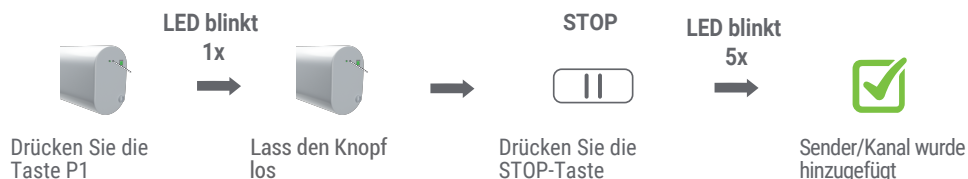

-  Sind KEINE Endlagen eingestellt, bewegt sich das Produkt im Impuls-/Schrittbetrieb. Gehen Sie dann zu SCHRITT 3. Sind Endlagen eingestellt, fährt das Produkt bis zu seiner Endlage weiter. Gehen Sie dann zu SCHRITT 5. WARNUNG: Möglicherweise wurden nicht die richtigen Endlagen eingestellt. Gehen Sie dann zu OPTION A.

Schritt 3 Drehrichtung einstellen

(Nur wenn die Drehrichtung nicht stimmt)

Nur möglich, wenn keine Endlagen eingestellt sind.

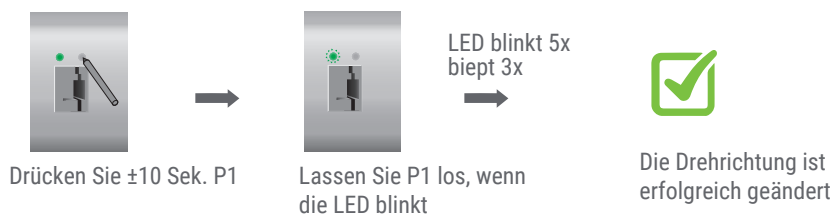

Schritt 4 Einstellen der Endgrenzen

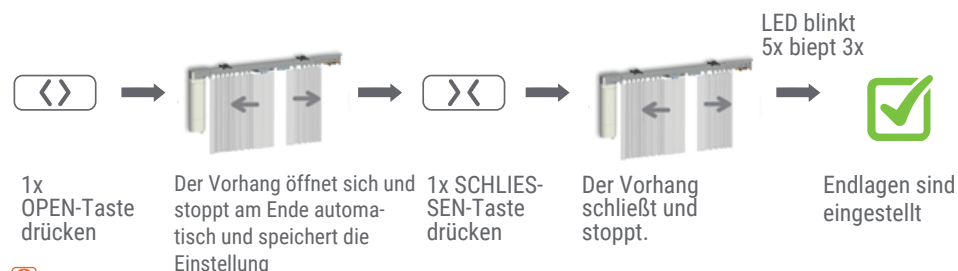

-  **Die Vorhänge sind nun einsatzbereit.**

-  Wenn Sie mit dem Ergebnis der Einstellung der Endlagen nicht zufrieden sind, gehen Sie zu Option A-Positionen anpassen oder Werkseinstellungen zurücksetzen.

Schritt 5 Favoritenposition einstellen (falls gewünscht)



Gehen Sie zur gewünschten favoriten position

1x P2 drücken

1x STOP drücken

1x STOP drücken

i Halten Sie STOP 3 Sekunden lang gedrückt, um zur favoriten position zu gelangen.

i Da das Verfahren identisch ist, wiederholen Sie die Schritte, um es zu entfernen.

Zusätzliche Einstellungen

Option A Einstellen der offenen Position

i Wenn eine Anpassung nicht möglich ist, gehen Sie zu Werkseinstellungen zurücksetzen.

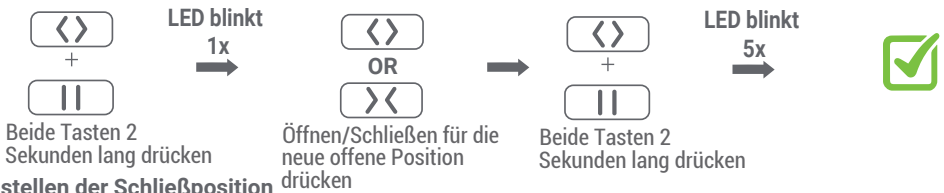

Beide Tasten 2 Sekunden lang drücken

Öffnen/Schließen für die neue offene Position drücken

Beide Tasten 2 Sekunden lang drücken

Einstellen der Schließposition

i Wenn eine Anpassung nicht möglich ist, gehen Sie zu Werkseinstellungen zurücksetzen.

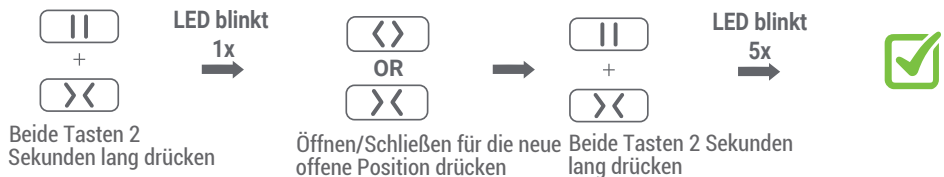

Beide Tasten 2 Sekunden lang drücken

Öffnen/Schließen für die neue offene Position drücken

Beide Tasten 2 Sekunden lang drücken

Option B Lernen Sie zusätzlichen Sender/Kanal

i Stellen Sie sicher, dass sich der neue Sender im gewünschten Kanal befindet.

a = Bereits vorhandener Sender/Kanal

b = Neuer Sender/Kanal

△NOTE Um den Sender / Kanal zu löschen, wiederholen Sie den Vorgang.

Method 1

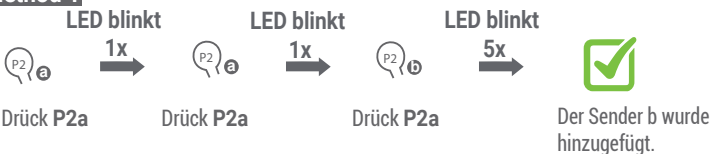

Drück P2a

Drück P2a

Drück P2a

Der Sender b wurde hinzugefügt.

Method 2 (Falls der alte Sender verloren geht oder kaputt geht)



Drück P1

Drücken Sie 1xSTOP oder b.

Der neue Sender b wurde hinzugefügt.

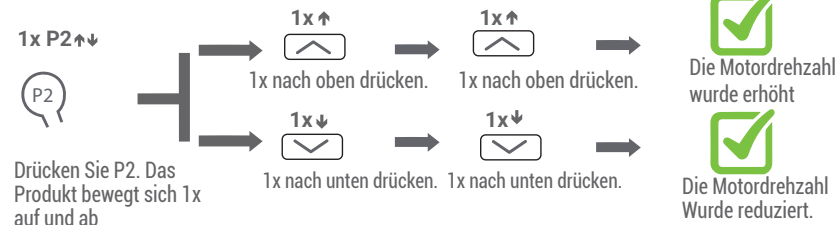
Option C Geschwindigkeitskontrolle

ⓘ Reagiert der Motor nach dieser Aktion NICHT, befindet er sich bereits auf der höchsten oder niedrigsten Drehzahl.

ⓘ Es gibt 3 verschiedene Geschwindigkeiten.

ⓘ Wenn die Geschwindigkeit geändert wurde, wird der Langsamstopp aktiviert. Um den langsamen Stopp zu deaktivieren, müssen Sie den Motor zurücksetzen.

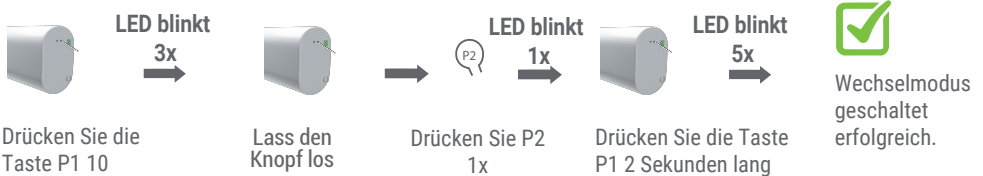
Externer Schaltermodus Drucktastenschaltermodus (Werkseinstellung)

Drücken Sie die Taste P1 10 Sekunden lang

Lass den Knopf los

Drücken Sie P2 1x

Drücken Sie die Taste P1 2 Sekunden lang

Mechanischer Schaltermodus

Überprüfen Sie, ob die oberen und unteren Grenzwerte eingestellt sind, der Motor ist eingeschaltet (1 Jog), innerhalb von 10 Sek

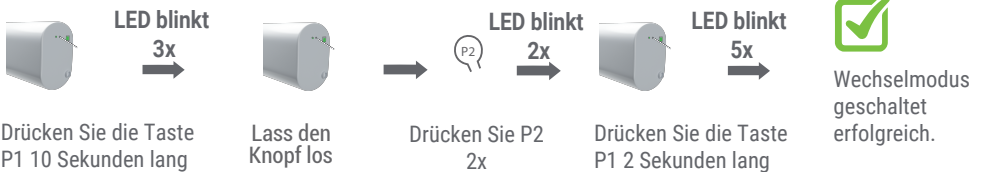

Drücken Sie die Taste P1 10 Sekunden lang

Lass den Knopf los

Drücken Sie P2 2x

Drücken Sie die Taste P1 2 Sekunden lang

Elektronischer Schaltermodus

Überprüfen Sie, ob die oberen und unteren Grenzwerte eingestellt sind, der Motor ist eingeschaltet (1 Jog), innerhalb von 10 Sek.

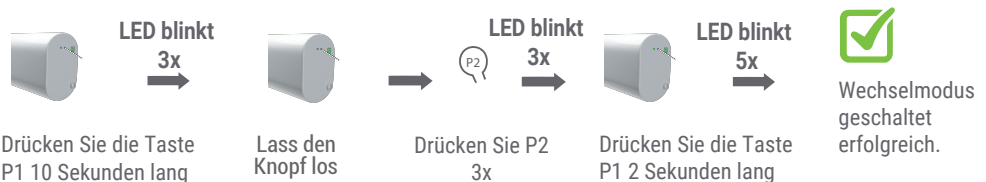

Drücken Sie die Taste P1 10 Sekunden lang

Lass den Knopf los

Drücken Sie P2 3x

Drücken Sie die Taste P1 2 Sekunden lang

Einknopf-Druckknopfschaltermodus

Überprüfen Sie, ob die oberen und unteren Grenzwerte eingestellt sind, der Motor ist eingeschaltet (1 Jog), innerhalb von 10 Sek.

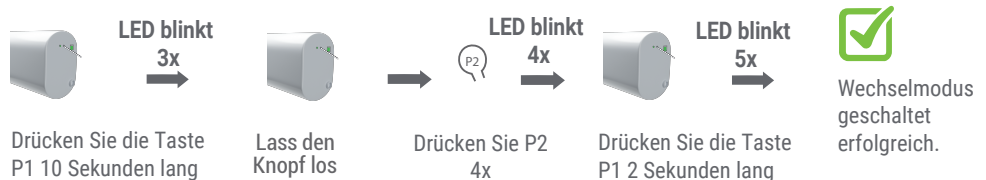

Drücken Sie die Taste P1 10 Sekunden lang

Lass den Knopf los

Drücken Sie P2 4x

Drücken Sie die Taste P1 2 Sekunden lang

Zusätzliche Einstellungen Taste P1 Ohne Sender als Bedientaste verwendbar.



Das LED-Licht blinkt beim Drücken von P1

Manuelle Kontrolle



Drücken Sie die Taste P1

Lass den Knopf los

Drücken Sie die STOP-Taste

Manuelle Steuerung wurde (de)aktiviert.

Ausschalten des Empfängers



Halten Sie P1 gedrückt, bis das LED-Licht 2x blinkt.

Der Empfänger ausgeschaltet.

Um den Empfänger wieder zu aktivieren, drücken Sie einmal kurz auf P1.

Drehrichtung ändern

Methode 1 (mit Endgrenzen)



Drücken und halten Sie P1 für 10s

Lass den Knopf los

1 Sekunde drücken

Die Richtung von Drehung hat sich geändert.

Method 2 (without end limits)

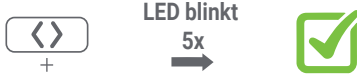

Beide Tasten 2 Sek. drücken

Die Richtung von Drehung hat sich geändert.

Zurücksetzen auf Werkseinstellungen



Drücken Sie die Taste P1 14 Sekunden lang

Lass den Knopf los

Zurücksetzen auf Werkseinstellungen.

So übernehmen Sie neue Einstellungen: Gehen Sie zu Schritt 1





INSTALLATION MANUEL

Moteur manuel de rail de rideau Wi-Fi bidirectionnel Brel

BG-980

Lisez le manuel avant de commencer l'installation. Le non-respect de ces instructions peut entraîner des défauts et des blessures pour lesquels la garantie ne peut être invoquée.



www.brel-home.com

Visitez notre site Web pour plus de manuels et d'informations



BG-980

Scannez le code QR ici pour que le manuel téléchargeur et visionner des vidéos

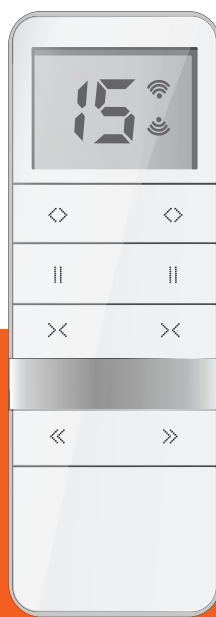

Table des matières

Avertissement	2
Câblage/installation du moteur/compatible avec hub	3
Données techniques du moteur/distances de fonctionnement/chargement du moteur	4
Fonctions de la commande	5
Paramètres	5

Avertissement



Ne pas travailler avec le moteur dans des environnements humides



BREL-Motors déclare que ce moteur a été fabriqué selon les directives de la norme CE 1999/5/CE



Le moteur doit être protégé contre l'influence directe de l'humidité



Maintenez l'antenne en bon état et ne la raccourcissez pas. L'antenne ne doit pas entrer en contact avec d'autres pièces métalliques, sinon la performance en sera réduite



Le moteur doit être installé correctement



Ne laissez pas les enfants jouer avec l'unité de commande du store enrouleur. Gardez les télécommandes hors de portée des enfants. Les enfants ne peuvent pas reconnaître les dangers des équipements électriques et ne sont donc pas autorisés à travailler avec

Conservez ces instructions pour référence ultérieure.

Installation de commutation du moteur de rideau

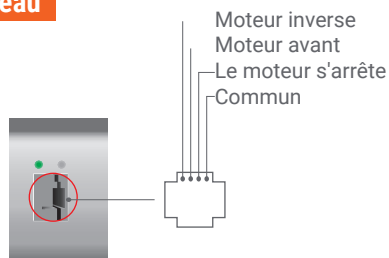
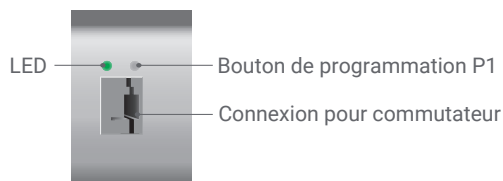

Fonctionne avec l'application BREL HOME

Il vous suffit de télécharger notre application BREL HOME pour faire fonctionner le moteur avec votre mobile/téléphone portable.

Comme il s'agit d'un moteur wifi, il peut être connecté à l'application BREL HOME sans utiliser de hub.

Vous connectez le moteur via l'application sur votre réseau Wifi domestique et vous pouvez installer le moteur comme décrit dans l'application.

Si vous souhaitez installer le moteur par émetteur, vous devez suivre les étapes de ce manuel.

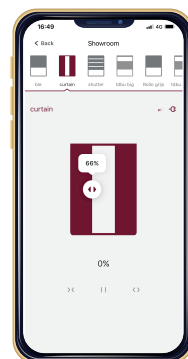

Données techniques du moteur

BG-980

Couple	1.2 nm
Vitesse d'ouverture/fermeture	14 cm per sec.
Moteur de tension	AC 100-240V
Max. Poids du rideau	40 kg
Fréquence radio	433.925MHz
Protection contre l'humidité et la poussière	IP20
Transmetteurs de capacité de stockage	Jusqu'à 20 canaux
Plage de température du moteur	Utilisation normale : -5°C to +55°C
Fréquence	433Mhz 2.4Ghz (wifi)



Fonctions Télécommande

DD-1852

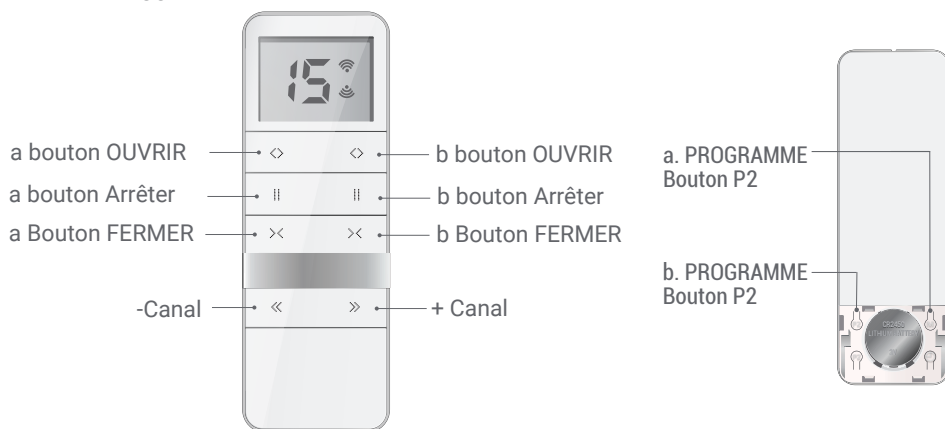

BG980

Scannez le code QR pour voir le manuel et les vidéos d'instructions

Atteindre

L1 = 100 meter

L2 = 20 meter

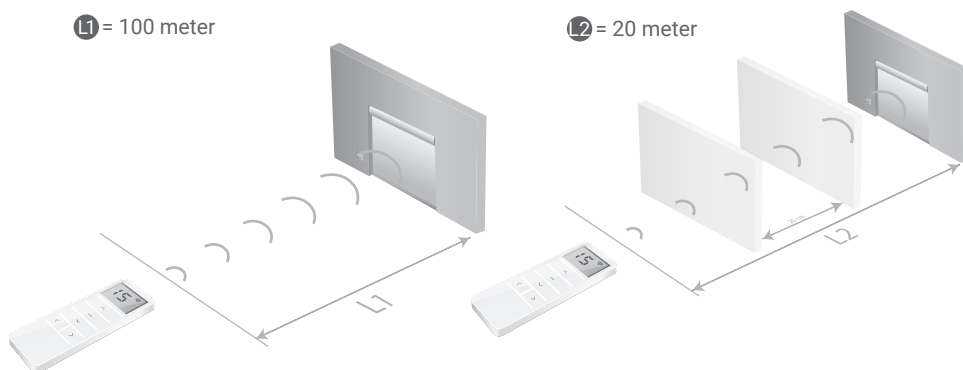

Étape 1 Configuration de la première télécommande/canal

i La télécommande peut transmettre 15 canaux et donc contrôler plusieurs stores. Sélectionnez d'abord un canal pour la commande du volet roulant concerné. Assurez-vous de sélectionner une chaîne gratuite (nous ne recommandons qu'un seul produit par chaîne).



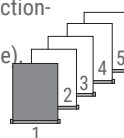

i Cette télécommande a également le canal 0. Tous les stores programmés dans le canal 1~15 sont automatiquement programmés dans ce canal 0 et peuvent être actionnés tous en même temps.

i Si vous avez sélectionné le mauvais canal, accédez à Réinitialisation des paramètres d'usine.

► **Sélectionnez le canal souhaité.**



Étape 2 Établir la connexion

-  Dans les procédures décrites ici, il y a un intervalle maximum de 10 secondes pour terminer chaque action suivante : si vous attendez plus longtemps, le système quittera le mode d'édition.
-  Normalement, il suffit d'appuyer brièvement sur un bouton. Si vous devez appuyer sur un bouton et le maintenir enfoncé pendant plusieurs secondes, cela sera clairement indiqué.
-  Le système confirmera chaque étape complétée en déplaçant le store de haut en bas (*).
-  Si une procédure ne se déroule pas comme décrit, attendez 20 secondes et recommencez depuis le début de cette étape/procédure.



-  Si AUCUNE position finale n'est définie, le produit se déplacera en mode impulsion/pas. Passez ensuite à l'ÉTAPE 3.
- Si des positions finales sont définies, le produit continuera jusqu'à sa position finale. Passez ensuite à l'ÉTAPE 5.

Étape 3 Réglage du sens de rotation (Uniquement si le sens de rotation n'est pas correct)

Uniquement possible si aucune position finale n'est réglée.

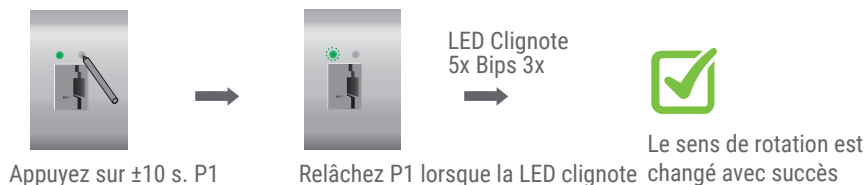

Étape 4 Définition des limites de fin

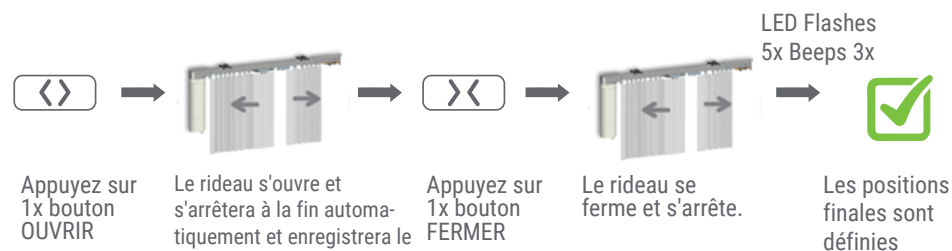

-  **Les rideaux sont maintenant prêts à l'emploi.**
-  Si vous n'êtes pas satisfait du résultat du réglage des positions finales, passez à l'Option A - Réglage des positions ou Réinitialisation des paramètres d'usine.

Étape 5 Réglage de la position favorite (si désiré)



i Appuyez sur STOP et maintenez-le enfoncé pendant 3 secondes pour passer à la position favorite.

i La procédure étant identique, pour le supprimer, répétez les étapes.

Paramètres additionnels

Option A Réglage de la position ouverte

i Si le réglage n'est pas possible, passez à la réinitialisation des paramètres d'usine.

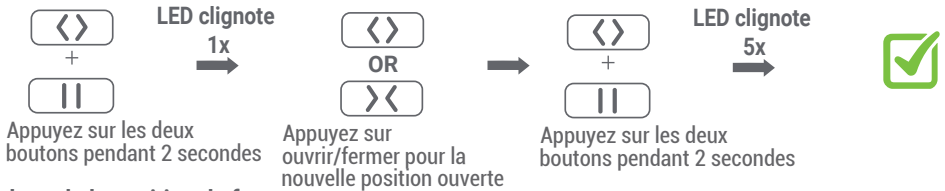

Réglage de la position de fermeture

i Si le réglage n'est pas possible, passez à la réinitialisation des paramètres d'usine.

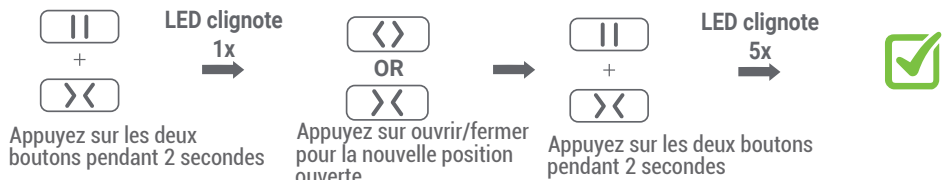

Option B Émetteur/canal supplémentaire

i Assurez-vous que le nouvel émetteur est dans le canal souhaité.

a = Émetteur/canal déjà existant

b = Nouvel émetteur/canal

NOTE Pour supprimer l'émetteur/le canal, répétez la procédure.

Method 1

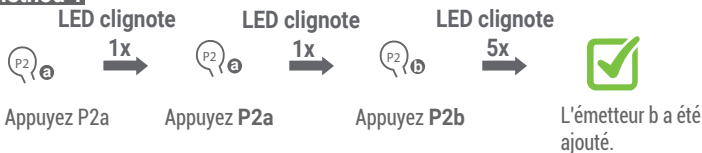

Method 2 (Au cas où l'ancien émetteur est perdu ou cassé)

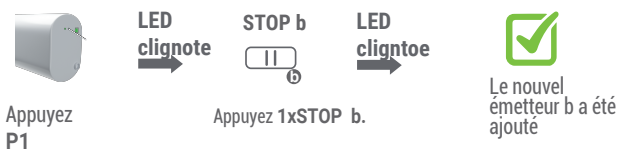

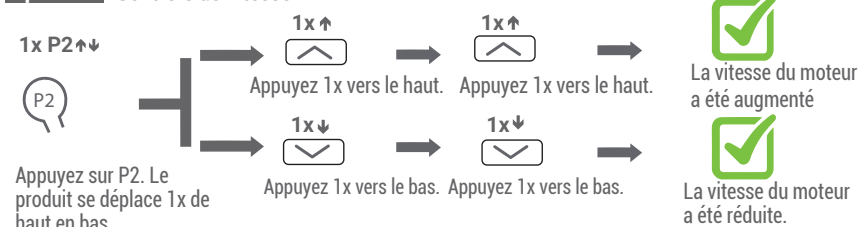
Option C Contrôle de vitesse

! Si le moteur ne réagit PAS après cette action, il est déjà à la vitesse la plus élevée ou la plus basse.

! Il existe 3 vitesses différentes.

! Si la vitesse a été modifiée, l'arrêt lent est activé. Pour désactiver l'arrêt lent, vous devez réinitialiser le moteur.

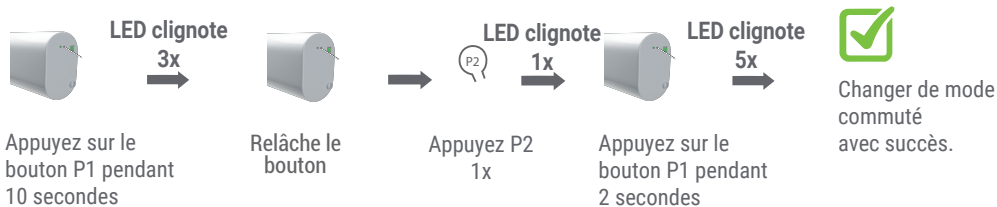
Mode de commutation externe Mode de commutation par bouton-poussoir (réglage d'usine)**Mode de commutation mécanique**

Vérifiez que les limites supérieure et inférieure sont définies, que le moteur est sous

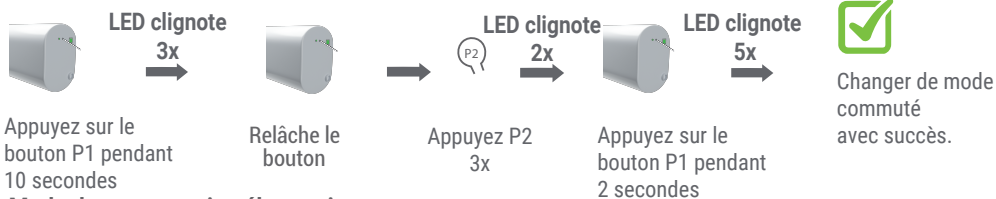
**Mode de commutation électronique**

Vérifiez que les limites supérieure et inférieure sont définies, que le moteur est sous tension (1 jogging), dans les 10S.

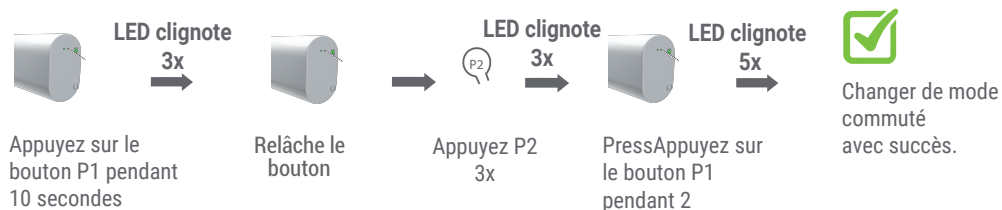
**Mode de commutation à bouton-poussoir unique**

Vérifiez que les limites supérieure et inférieure sont définies, que le moteur est sous tension (1 jogging), dans les 10S.

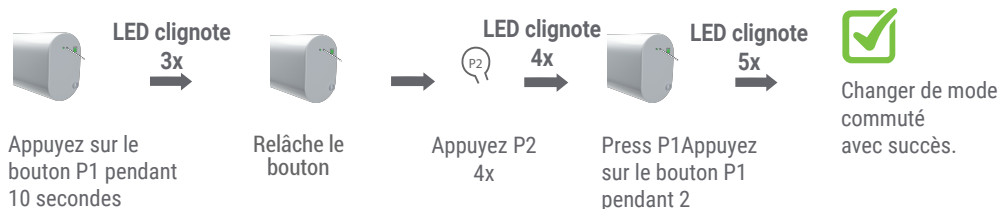

Paramètres supplémentaires Touche P1 Peut être utilisé sans émetteur comme bouton de commande.



Le voyant LED clignote lorsque vous appuyez sur P1

Contrôle manuel



Appuyez sur le bouton P1 pendant 10s

Relâchez le bouton

Appuyez sur le bouton STOP

Le contrôle manuel a été (dé)activé.

Eteindre le récepteur



Appuyez et maintenez P1 jusqu'à ce que le voyant LED clignote 2x.

Le récepteur éteint.

Pour réactiver le récepteur, appuyez brièvement une fois sur P1.

Changer le sens de rotation

Méthode 1 (avec limites finales)



Appuyez et maintenez P1 pendant 10s

Relâchez le bouton

Appuyez 1 seconde

La direction de la rotation a changé.

Méthode 2 (sans limites finales)



Appuyez sur les deux boutons pendant 2 secondes

La direction de la rotation a changé.

Réinitialisation aux paramètres d'usine



Appuyez sur le bouton P1 pendant 14 secondes

Relâche le bouton P1

Réinitialise les paramètres

i Pour appliquer de nouveaux paramètres : passez à l'étape 1

Remplacement des piles

