



BREL HOME



CATALOG 2025

BREL HOME

Valid until further notice | Gross prices excl. VAT

Online catalog is final

V2025-01EN



CONTENTS

■ Price overview	4
■ Experience it with BREL	6
■ Outdoor blinds	9
Solar	10
230 volt radio	18
230 volt standard	22
■ Indoor blinds	34
System motors	36
Tubular motors	46
Matter motors	54
Adaption schedule	64
Curtaintrack motors	67
■ Project blinds	72
Potential-free switching	74
Project motors	75
■ Smart Home	79
■ Remote Controls	85
■ Training	97
■ Promotion	98
■ Warrenty	99
■ Logistics	100
■ Customer service	101
■ Calculation tool	102
■ Terms and conditions	105



EXPERIENCE IT WITH BREL

Specialized in motorization of blinds



Since 2004, BREL has been marketing motors for controlling sun blinds. From 2013, this will be done from Brel Nederland BV under the brand name BREL HOME. We supply motors to all major manufacturers in Europe.

Pioneers

Our company is characterized by reliability and innovation. We were the first with battery motors in the Netherlands and the first with a Solar solution for outdoor sun blinds. We offer different types of solar panels. We pioneer to increase living comfort in a sustainable and affordable way.

Smart benefits

With our years of experience, we develop the best solutions for controlling and operating sun blinds. We list the advantages:

- Easy operation: with remote control and/or via the BREL HOME app.
- Rechargeable Li-Ion batteries, integrated into the product, safe and convenient.
- Burglar-retardant: roller shutters with BREL motors reduce the risk of burglary.
- Slow stop function: allows roller shutters or screens to close silently.
- Waterproof: all connections between cord, panel and motor are fitted with waterproof DIN plugs, for years of trouble-free use.
- No worries: once installed it works without any problems.
- Sustainable design: aimed at years of use, batteries are recycled according to the EU and UK government.
- CO2 reduction through tree planting for BREL SOLAR products.

Discover all BREL products online



A source of information

The BREL HOME website contains various types of information about the products. Each motor and/or transmitter is provided with specifications and the associated manuals for the installation of the product. In addition to the manuals, there are also short instructional videos about the installation of the motors, operation with the BREL HOME app and the handheld transmitters.

Knowing more? Go to www.brel-home.com

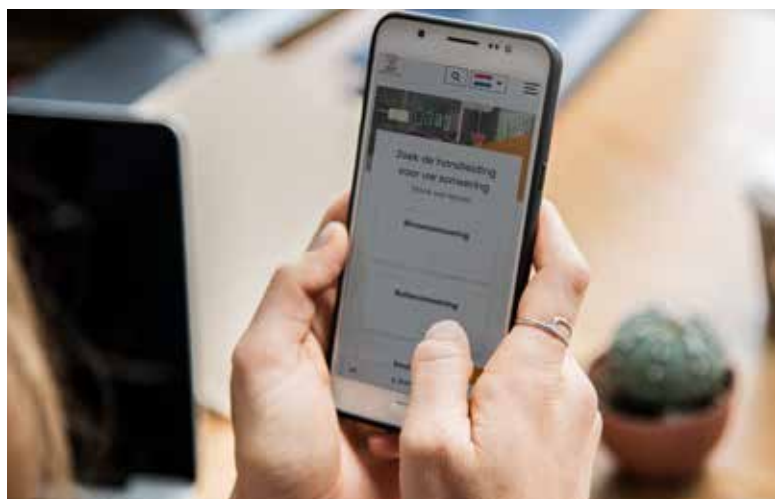

Find information easily

Use our handy configurator to quickly and easily obtain the correct information if you do not know which type of motor is in the sun blind. The manual simply explains how to program the motor.



Points of sale

The BREL HOME website also indicates which companies sell sun blinds with BREL motors. This makes you easier to find for consumers. Would you also like to be here with your company? Send an email to sales@brel-home.com



OUTDOOR BLINDS

BREL SOLAR

10

230 volt motors radio

18

230 volt motors standard

22



BREL SOLAR

Let the sun shine. Enjoy the energy!



Solar energy is the future

The sun gives us light and warmth every day. We enjoy the breaking rays of the sun to relax and to generate energy. The sun is our major energy source that we use at BREL HOME to create pleasant living comfort in and around your home.

By using solar energy for your living comfort, you are no longer dependent on the Current network and you use less energy. With BREL Solar we can easily and quickly create optimal indoor comfort without the need for air conditioning. This saves you energy costs. The sun charges the battery motors with which you raise or lower the blinds, roller shutters or screens. This way you contribute to a more sustainable world.



Simple and fast

Using our BREL SOLAR app you determine the perfect location with the most light for placing the solar panel. Useful during measuring and installation.



Solar motors

The standard BREL SOLAR motors are 13Nm and 20Nm. BREL has a 50Nm SOLAR motor for large screens and folding arm awnings and for small windows there is a 6Nm motor with external battery.

UNFOOTPRINT

BREL SOLAR solutions make a sustainable impact



Why plant trees?

Trees not only absorb CO₂, they have many other benefits. They provide biodiversity, shade, food and economic development.

There are many organizations worldwide that are involved in planting trees and/or preserving existing forests. We have chosen to work with unFootprint. They assessed on the basis of more than 30 principles and criteria. Trees for the Future emerged as the best organization.



What are the benefits of Trees for the Future?

Trees for the Future delivers a measurable positive impact on 9 of the 17 Sustainable Development Goals signed worldwide:

- No poverty;
- Zero hunger;
- Good Health and well-being;
- Decent work and economic growth;
- Reduced inequalities;
- Responsible consumption and production;
- Climate action;
- Life on land;
- Partnership for the goals.

SOLARIS 35

35mm 12V electronic DC radio motor with external battery with DIN plug



- Electronic limit setting
- Built-in receiver
- 12V DC with external Lithium battery
- For narrow roller shutters and screens (60cm)
- Waterproof DIN plug
- Low energy consumption
- Dot-move function
- Set includes battery DC-1276D (295x27x27) and BR1293 mounting bracket

TECHNICAL SPECIFICATIONS

Order code	Torque (Nm)	Speed (rpm)	Diameter (mm)	Motor Length (mm)	Cable Length (cm)	Power (W)	Current (A)	Tension (V)	Water resistance
BCE35-06	6	24	35	503	15	35	3.00	12	IP44

SOLARIS 35

35mm 12V electronic DC radio motor with DIN plug



- Electronic limit setting
- Built-in receiver
- 12V DC with built-in Lithium battery
- Waterproof DIN plug
- Cloth rack correction
- Obstacle detection and frost protection

TECHNICAL SPECIFICATIONS

Order code	Torque (Nm)	Speed (rpm)	Diameter (mm)	Motor Length (mm)	Cable Length (cm)	Power (W)	Current (A)	Tension (V)	Water resistance
BLE35-13 SHU	13	10	35	670	15	38	3.23	12	IP44

SOLARIS 45

45mm 12V electronic DC radio motor with DIN plug



- Electronic limit setting
- Built-in receiver
- 12V DC with built-in Lithium battery
- Waterproof DIN plug
- Cloth rack correction
- Obstacle detection and frost protection

TECHNICAL SPECIFICATIONS

Order code	Torque (Nm)	Speed (rpm)	Diameter (mm)	Motor Length (mm)	Cable Length (cm)	Power (W)	Current (A)	Tension (V)	Water resistance
BLE45-20	20	10	45	664	15	50	4.10	12	IP44

SOLARIS 45

45mm 12V electronic DC radio motor with DIN plug







- Electronic limit setting
- Built-in receiver
- 12V DC with built-in Lithium battery
- Waterproof DIN plug
- Cloth rack correction
- Especially for awnings, XL shutters and XL screens

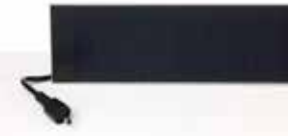

TECHNICAL SPECIFICATIONS

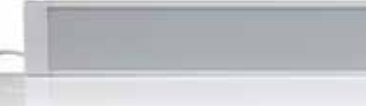
Order code	Torque (Nm)	Speed (rpm)	Diameter (mm)	Motor Length (mm)	Cable Length (cm)	Power (W)	Current (A)	Tension (V)	Water resistance
BLE45-40	50	12	45	664	15	74.4	6.2	12	IP44

SOLAR PANELS

Product	Description	Order code
	Solar panel with black housing, 5W with waterproof DIN plug 554 x 60 x 10 mm	NC-1290
	Solar panel without housing, 5W with waterproof DIN plug 570 x 56 x 3 mm	NC-1291
	Solar panel with black housing, 3W with waterproof DIN plug 320 x 60 x 10 mm	NC-1292
	Solar panel with black housing, 10W with waterproof DIN plug 1085 x 60 x 10 mm	NC-1295
	Solar panel with white housing, 4,4W with waterproof DIN plug 780 x 60 x 10 mm	NC-2090
	Glass solar panel, 5W with waterproof DIN plug 750 x 40 x 13 mm	NC-3090
	Mounting bracket NC-1290 or NC-1295 solar panel + battery Set 2 pieces	BR-1293

ACCESSORIES SOLARIS

Product	Description	Order code
	<p>Charger 12V EU male with DIN stekker male 300 cm cable length</p>	<p>DC-212</p>
	<p>Three-way plug DIN for Solar 2x DIN female 1x DIN male</p>	<p>Z-46-001</p>
	<p>DIN chargingpoint with fixing nut 5cm</p>	<p>Z-46-005</p>
	<p>Extension wire with DIN for Solar 1x DIN female 1x DIN male</p>	<p>Z-46-025/050/ 100/200/500</p>

COVERPLATES

Product	Description	Order code
	Coverplate for cable 35mm Solar motor Heroal screen 95	VAS35-HE-95
	Coverplate for cable 35mm Solar motor Heroal screen 105	VAS35-HE-105
	Coverplate for cable 45mm Solar motor AVZ screen 95	VAS45-AVZ-95
	Coverplate for cable 45mm Solar motor Heroal screen 95	VAS45-HE-95
	Coverplate for cable 45mm Solar motor Heroal screen 105	VAS45-HE-105
	Coverplate for cable 45mm Solar motor Heroal screen 125	VAS45-HE-125

■ This is our current range. Should you need different adaption, can always ask about the possibilities.
Please mail to sales@brel-home.com

230V MOTORS

Radio and standard motors 230 volt



230 volt radio motors

The radio motors from BREL all have the same bi-directional protocol, so the adjustment is the same for all motors. The BRE and BZE motors are special. These motors have several functionalities that the other 230 volt motors do not have, namely:

- Built-in receiver with Wifi
- Obstacle stop function
- Automatic fabric tension
- Up to 40 Nm

All 230 volt radio motors can be operated with our BREL HOME app.

Standard motors

The standard 230V motors up to 300 Nm can be controlled via a switch or home automation system. The standard motor can also be operated with a transmitter if a separate receiver is installed.



TRITON 35

35mm 230V electronic radio motor extra quiet

Outgoing - replacement is BEMQ35-10



- Electronic limit setting
- Built-in receiver
- 230V AC
- Dot-move function
- Extra quiet (54db)

TECHNICAL SPECIFICATIONS

Order code	Torque (Nm)	Speed (rpm)	Diameter (mm)	Motor Length (mm)	Cable Length (cm)	Power (W)	Current (A)	Tension (V)	Water resistance
BEQ35-10	10	17	35	580	500	144	0.63	230	IP44

TRITON 35

35mm 230V mechanic radio motor

While stocks last



- Mechanic limit setting
- Built-in receiver
- 230V AC
- Dot-move function

TECHNICAL SPECIFICATIONS

Order code	Torque (Nm)	Speed (rpm)	Diameter (mm)	Motor Length (mm)	Cable Length (cm)	Power (W)	Current (A)	Tension (V)	Water resistance
BR35-10	10	17	35	590	500	121	0.53	230	IP44
BR35-13	13	14	35	590	500	121	0.53	230	IP44

TRITON 45

45mm 230V mechanic radio motor



- Mechanic limit setting
- Built-in receiver
- 230V AC
- Dot-move function

TECHNICAL SPECIFICATIONS

Order code	Torque (Nm)	Speed (rpm)	Diameter (mm)	Motor Length (mm)	Cable Length (cm)	Power (W)	Current (A)	Tension (V)	Water resistance
BR45-20	20	15	45	612	500	145	0.64	230	IP44
BR45-40	40	15	45	643	500	198	0.86	230	IP44

TRITON 45

45mm 230V electronic radio motor with WiFi



- Electronic limit setting
- Built-in receiver met WiFi
- Obstacle stop function
- Especially for roller shutters

TECHNICAL SPECIFICATIONS

Order code	Torque (Nm)	Speed (rpm)	Diameter (mm)	Motor Length (mm)	Cable Length (cm)	Power (W)	Current (A)	Tension (V)	Water resistance
BRE45-20	20	15	45	610	500	161	0.69	230	IP44
BRE45-40	40	15	45	663	500	228	0.99	230	IP44

TRITON 45

45mm 230V electronic radio motor with WiFi



- Electronic limit setting
- Built-in receiver with WiFi
- 230V AC
- Obstacle stop function
- Automatic fabric tension
- Especially for awnings and screens

TECHNICAL SPECIFICATIONS

Order code	Torque (Nm)	Speed (rpm)	Diameter (mm)	Motor Length (mm)	Cable Length (cm)	Power (W)		Tension (V)	Water resistance
BZE45-20	20	15	45	613	500	161	0.69	230	IP44
BZE45-40	40	15	45	660	500	228	0.99	230	IP44

TRITON 45

45mm 230V electronic radio motor extra short



- Electronic limit setting
- Built-in receiver
- 230V AC
- Dot-move function
- Third limit
- Extra short

TECHNICAL SPECIFICATIONS

Order code	Torque (Nm)	Speed (rpm)	Diameter (mm)	Motor Length (mm)	Cable Length (cm)	Power (W)	Current (A)	Tension (V)	Water resistance
BEK45-10	10	15	45	410	300	113	0.48	230	IP44

EZIO 35

35mm 230V standard motor

MS35-13 while stocks last



- Mechanic limit setting
- 230V AC

- Work plug on request

TECHNICAL SPECIFICATIONS

Order code	Torque (Nm)	Speed (rpm)	Diameter (mm)	Motor Length (mm)	Cable Length (cm)	Power (W)	Current (A)	Tension (V)	Water resistance
MS35-10	10	17	35	476	300	121	0.53	230	IP44
MS35-13	13	14	35	476	300	121	0.53	230	IP44

EZIO 35

35mm 230V standard motor extra short

While stocks last



- Mechanic limit setting
- 230V AC

- Extra short

TECHNICAL SPECIFICATIONS

Order code	Torque (Nm)	Speed (rpm)	Diameter (mm)	Motor Length (mm)	Cable Length (cm)	Power (W)	Current (A)	Tension (V)	Water resistance
MSD35-10	10	17	35	396	300	121	0.53	230	IP44

EZIO 35

35mm 230V standard motor extra quiet



- Mechanic limit setting
- 230V AC

- Extra quiet (54 db)

TECHNICAL SPECIFICATIONS

Order code	Torque (Nm)	Speed (rpm)	Diameter (mm)	Motor Length (mm)	Cable Length (cm)	Power (W)	Current (A)	Tension (V)	Water resistance
MBQ35-06	6	28	35	512	300	121	0.53	230	IP44
MBQ35-10	10	17	35	512	300	142	0.62	230	IP44

EZIO 45

45mm 230V standard motor



- Mechanic limit setting
- 230V AC

- Work plug on request

TECHNICAL SPECIFICATIONS

Order code	Torque (Nm)	Speed (rpm)	Diameter (mm)	Motor Length (mm)	Cable Length (cm)	Power (W)	Current (A)	Tension (V)	Water resistance
MS45-20	20	15	45	476	300	145	0.64	230	IP44
MS45-40	40	15	45	540	300	198	0.86	230	IP44

EZIO 55

55mm 230V standard motor



- Mechanic limit setting
- 230V AC

- Centered in tube 85

TECHNICAL SPECIFICATIONS

Order code	Torque (Nm)	Speed (rpm)	Diameter (mm)	Motor Length (mm)	Cable Length (cm)	Power (W)	Current (A)	Tension (V)	Water resistance
MS55-60	60	12	55	605	300	320	1.39	230	IP44
MS55-80	80	12	55	605	300	385	1.65	230	IP44
MS55-120	120	7	55	630	300	393	1.68	230	IP44

EZIO 92

92mm 230V standard motor with manual override



- Mechanic limit setting
- 230V AC

- Manual override

TECHNICAL SPECIFICATIONS

Order code	Torque (Nm)	Speed (rpm)	Diameter (mm)	Motor Length (mm)	Cable Length (cm)	Power (W)	Current (A)	Tension (V)	Water resistance
MH92-300	300	9	92	605	300	940	4.08	230	IP44

ACCESSORIES EZIO

Product	Description	Order code
	Receiver Bi-directional IP55	RW340
	Dry contact receiver for Home automation	RW100
	Flush-mounted receiver for light	RW101
	Surface mounted receiver for wall socket with integrated switch with Z-68C	RW120
	Flush-mounted receiver for wall socket with integrated switch	RW110
	Work plug STAS 3 Male double earthed	Z-22
	Work plug STAK 3 Female double earthed	Z-23
	Hirschmann work plug STASI 3 clip	Z-24

ACCESSORIES EZIO

Product	Description	Order code
	Adjustment cable	Z-25
	Cable 3-wired 0,75m ² per 100m	Z-33
	Cable with plug 300cm	Z-40-300
	Cable 4-wired 0,75m ² per 100m	Z-44
	Switch Cream White Bi-directional	SW020
	Switch White Bi-directional	SWU020
	Work plug STAK 3 Female double earthed	DC-134
	Relay central control parallel switching	DC-209

ADAPTION

Product	Description	Order code
	Adaption tube 8K40 35mm motor A8K40-35	A8K40-35C + A8K40-35W
	Adaption tube 41 35mm motor A41-35	A41-35C + A41-35W
	Adaption tube 50 35mm motor A50-45	A50-35C + A50-35W
	Adaption 35mm motor for 45mm Tube	V35-45
	Adaption tube 8K50 45mm motor A8K50-45	A8K50-45C + A8K50-45W
	Adaption tube 8K60/63 45mm motor A8K60/63-45	A8K60/63-45C + A8K60/63-45W
	Adaption tube 63 45mm motor A63-45	A63-45C + A63-45W
	Adaption zipscreen tube 8K60/63 45mm motor AZ63-45	AZ63C + A8K60/63-45W

ADAPTION

Product	Description	Order code
	<p>Bung 'no-motor side' zipscreen tube 63</p>	<p>DZ-63</p>
	<p>Adapter ring 45 mm motor universal adapter</p>	<p>V45-UN</p>
	<p>Shaft adapter fitting to universal pipe</p>	<p>ASW35/45</p>
	<p>Adaption tube 70 45mm motor A70-45</p>	<p>A70-45C + A70-75W</p>
	<p>Adaption tube A8K70 45mm motor A8K70-45</p>	<p>A8K70-45C + A8K70-45W</p>
	<p>Adaption tube 78 45mm motor A78-45</p>	<p>A78-45C + A78-45W</p>
	<p>Adaption zipscreen tube 70 45mm motor AZ78-45</p>	<p>AZ78C + A78-45W</p>
	<p>Adaption tube 79 45mm motor A79-45</p>	<p>A79-45C + A79-45W</p>

ADAPTION

Product	Description	Order code
	Adaption tube 85 45mm motor A85-45	A85-45C + A85-45W
	Adaption tube 100 45mm motor A100-45	A100-45C + A100-45W
	Adaption tube A8K70 55mm motor A8K70-55	A8K70-55C + A8K70-55W
	Adaption tube 78 55mm motor A78-55	A78-55C + A78-55W
	Adaption tube 85 55mm motor A85-55	A85-55C + A85-55W
	Adaption tube 100 55mm motor A100-55	A100-55C + A100-55W
	Adaption tube 110 55mm motor A110-55	A110-55C + A110-55W
	Adaption 55mm motor for 59mm tube	V55-59

ADAPTION

Product	Description	Order code
	Adaption tube 100 92mm motor A100-92	A100-92C + A100-92W
	Adaption tube 107 92mm motor A107-92	A107-92C + A107-92W
	Adaption tube 125 92mm motor A125-92	A125-92C + A125-92W
	Adaption tube 160 92mm motor A160-92	A160-92C + A160-92W

■ This is our current range. Should you need different adaption, can always ask about the possibilities.
 Please mail to sales@brel-home.com

MOTORBRACKETS

Product	Description	Order code
	Adaption motor 35mm electronic motor crown	KR-35-E
	Adaption motor 35mm standard motor	KR-35-S
	Motorbracket 45mm crown	KR-45
	Motorbracket crown 137 137, 150, 165 or 180 max. 30 Nm	KR-137/KR-150/KR-165-KR-180
	Motorbracket roller shutter max. 30 Nm	BR-45
	Motorbracket awnings max. 50 Nm	BZ-45
	Motorbracket square 55mm motor max. 120 Nm	BZ-55
	Motorbracket screen 85	BR-85

MOTORBRACKETS

Product	Description	Order code
	<p>Motorbracket screen 95</p>	<p>BR-95</p>
	<p>Motorbracket roller shutter 137, 150, 165 of 180 max. 30 Nm</p>	<p>BR-137/BR-150/BR-165-BR-180</p>
	<p>Motor shaft 35mm motor</p>	<p>BW-35</p>
	<p>Motor shaft 45mm motor</p>	<p>BW-45</p>
	<p>Adaption 35mm motor for 45mm tube universal</p>	<p>V35-45 UN</p>
	<p>Armbracket headrail While stocks last</p>	<p>H-Topstuk-9001/9010/9999/ANO</p>
	<p>Drop-arm with spring While stocks last</p>	<p>H-Windvast-9001/9010/9999/ANO</p>
	<p>Bearing pin 12mm 30mm of 50mm</p>	<p>V-A12-30 V-A12-50</p>



INDOOR BLINDS

System motors

36

Tubular motors

46

Matter

54

Adaption schedule

64

Curtaintrack motors

67



SYSTEM MOTORS

Motorization for the smallest systems



The motor specialist for pleated curtains

BREL HOME has 5 different motors for pleated blinds. For the standard pleated blinds we have the Juno side motor and the Juno center motor. In addition, BREL HOME has 2 patent-registered motors: Juno for Top-Down-Bottom-Up pleated blinds and the Juno for slanting pleated blinds. The latest motor for pleated blinds is the Juno for horizontal pleated blinds with endless cords that are suitable for patio covers and verandas.



System motors

In addition to pleated blinds, the Juno side motor and Juno middle motor can be used for small roman and roller blinds and venetian blinds 25mm. Motors can be supplied with power via a battery pack or a transformer.



Tilt only

BREL HOME has the Juno Tilt only motor for 50mm venetian blinds. This tilts the slats, but manual override is also possible. This means that existing blinds can also be motorized.

JUNO

24mm 12V electronic DC radio motor single shaft



- Electronic limit setting
- Built-in receiver
- Dot-move function
- Third limit
- Automatic power off switch
- Backlash compensation for axis
- Theoretical runtime motor, fully charged battery (650 ~ 950 Mah) and maximum power: 90 min
- Theoretical runtime motor, fully charged battery (2000 ~2600 Mah) and maximum power: 200 min

TECHNICAL SPECIFICATIONS

Order code	Torque (Nm)	Speed (rpm)	Diameter (mm)	Motor Length (mm)	Cable Length (cm)	Power (W)	Current (A)	Tension (V)	Water resistance
BJE24S	0.6	34	24	129	30	8	1.00	12	IP20

JUNO

24mm 12V electronic DC radio motor double shaft



- Electronic limit setting
- Built-in receiver
- Dot-move function
- Third limit
- Automatic power off switch
- Backlash compensation for axis
- Theoretical runtime motor, fully charged battery (650 ~ 950 Mah) and maximum power: 60 min
- Theoretical runtime motor, fully charged battery (2000 ~2600 Mah) and maximum power: 150 min

TECHNICAL SPECIFICATIONS

Order code	Torque (Nm)	Speed (rpm)	Diameter (mm)	Motor Length (mm)	Cable Length (cm)	Power (W)	Current (A)	Tension (V)	Water resistance
BJE24D	0.8	34	24	190	30	14	1.18	12	IP20

JUNO

24mm 12V patent registered electronic DC radio motor TDBU



- Electronic limit setting
- Built-in receiver
- Dot-move function
- Third limit
- Automatic power off switch
- Backlash compensation for axis
- Theoretical runtime motor, fully charged battery (2000 ~2600 Mah) and maximum power: 120 min

TECHNICAL SPECIFICATIONS

Order code	Torque (Nm)	Speed (rpm)	Diameter (mm)	Motor Length (mm)	Cable Length (cm)	Power (W)	Current (A)	Tension (V)	Water resistance
BJE24TD	2X0.6	34	24	320	30	8	0.63	12	IP20

JUNO

24mm 12V patent registered electronic DC radio motor Triangle



- Electronic limit setting
- Built-in receiver
- Dot-move function
- Third limit
- Automatic power off switch
- Backlash compensation for axis
- Theoretical runtime motor, fully charged battery (2000 ~2600 Mah) and maximum power: 120 min

TECHNICAL SPECIFICATIONS

Order code	Torque (Nm)	Speed (rpm)	Diameter (mm)	Motor Length (mm)	Cable Length (cm)	Power (W)	Current (A)	Tension (V)	Water resistance
BJE24TR	2X0.6	34	24	320	30	8	0.63	12	IP20

JUNO

24mm 12V electronic DC radio motor for endless cord pleated blinds



- Electronic limit setting
- Built-in receiver
- Dot-move function
- Third limit
- Automatic power off switch
- Backlash compensation for axis
- Theoretical runtime motor, fully charged battery (650 ~ 950 Mah) and maximum power: 95 min
- Theoretical runtime motor, fully charged battery (2000 ~2600 Mah) and maximum power: 280 min

TECHNICAL SPECIFICATIONS

Order code	Torque (Nm)	Speed (rpm)	Diameter (mm)	Motor Length (mm)	Cable Length (cm)	Power (W)	Current (A)	Tension (V)	Water resistance
BJE24S/Q	0.6	34	24	129	30	8	1.00	12	IP20
BJE24D/Q	0.8	34	24	190	30	14	1.18	12	IP20

JUNO

5V Tilt only electronic DC radio motor micro USB set incl. Battery and charging point



- Electronic limit setting
- Built-in receiver
- Dot-move function
- Third limit
- 5V DC motor
- Can be operated with wand
- Charging point white (W) or black (B)
- Outgoing axis square 6mm
- Outgoing axis hex 5mm

TECHNICAL SPECIFICATIONS

Order code	Torque (Nm)	Speed (rpm)	Diameter (mm)	Motor Length (mm)	Cable Length (cm)	Power (W)	Current (A)	Tension (V)	Water resistance
BTE50-W BTE50-B	0.6	10	31	91	X	5	0.54	8.4	IP20

ACCESSORIES USB-C

Product	Description	Order code
	Battery 12V 2600Mah charging USB-C / motor JST 245 x 30 x 30 mm White or Black	DC-1278 (W/B)
	Battery 12V 650 mAh charging USB-C / motor JST 130 x 30 mm	DC-1330
	Battery 12V 2000Mah charging USB-C / motor JST 210 x 24 x 24 mm White or Black	DC-1340
	Solar panel with USB-C without housing 570 x 30 x 2.5mm	NC-4090
	USB cable with magnet 300 cm	Z-42-300M
	Magnetic plug USB-C	Z-42-02
	Charger 12V EU	DC-220
	Charger 12V UK	DC-221

ACCESSORIES DIN

Product	Description	Order code
	Battery 12V 950mAh charging DIN / motor JST	DC-1201
	While stocks last Battery 12V 2600Mah charging DIN / motor JST 245 x 30 x 30 mm White or Black	DC-1277 (W/B)
	Battery 12V 650 mAh charging DIN / motor JST 130 x 30 mm	DC-1329
	Three-way cable DIN 2x DIN female 1x DIN male	Z-41-001
	Extension cable DIN 1x DIN female 1x DIN male	Z-41-002
	Extension cable DIN 1x DIN female 1x DIN male	Z-41-025 / 50 / 100 / 200 / 500
	Charger 12V EU male with DIN plug male 300 cm cable length	DC-212
	Charger 12V UK male with DIN plug male 300 cm cable length	DC-213

ACCESSORIES JST

Product	Description	Order code
	Three-way cable JST 2x JST female 1x JST male	Z-43-001
	Extension cable JST 1x JST male 1x DIN male	Z-43-002
	Three-way cable JST 1x JST female 2x JST male	Z-43-003
	Extension cable JST 1x JST female 1x JST male	Z-43-025 / 050 / 100 / 200 / 500
	Transformer 12V EU 5A JST female max. 5 motoren	DC-232W
	Transformer 12V UK 5A JST female max. 5 motoren	DC-233W
	Transformer 12V EU JST female	DC-202
	Transformer 12V UK JST female	DC-203

ADAPTION

Product	Description	Order code
	Reducer 4k5	V4K5
	Reducer 4k5 with locking screw	V4K5-VA
	Reducer 6k5	V6K5
	Reducer 6k6	V6K6
	Reducer 4k5 Hunter Douglas	V-HD-R5
	Fixation for shaft 4k5	Z-75-4K5

MOTORBRACKETS

Product	Description	Order code
	Fixation bracket motor 24 HD VB/PB head	BP-24
	Motorbracket for Roman blinds Madrid	BPHEM-24
	Motorbracket for Roman blinds Valencia	BPHEV-24
	Motorbracket for Vako 20.04 Coulisse or Heditex-Valencia	BP-VA
	Battery holder DC1277 for Madrid rail	BP-HE-MA-1277
	Battery holder DC1277 for Valencia rail	BP-HE-VA-1277

TUBULAR MOTORS

Enjoy silently and comfortably



BREL HOME has developed a range of quiet motor especially for the automatic operation of the interior blinds. This allows you to enjoy your indoor blinds silently. The quiet motors for indoor blinds are:

- Lio 28
- Vesta 28
- Lio 35
- Nino 35



Universally rechargeable

To maintain indoor comfort, BREL HOME has also equipped its motors with the USB-C charging point. This concerns all battery motors that are suitable for indoor sun blinds. These motors are equipped with the USB-C charging point:

- Lio 15
- Lio 20
- Lio 25
- Lio 28
- Lio 35

LIO 15

15mm 5V electronic DC radio motor USB-C



- Electronic limit setting
- Built-in receiver
- 5V DC with built-in Lithium battery
- Low energy consumption
- Dot-move function
- Third limit
- Automatic power off switch

TECHNICAL SPECIFICATIONS

Order code	Torque (Nm)	Speed (rpm)	Diameter (mm)	Motor Length (mm)	Motorhead (mm)	Power (W)	Current (A)	Tension (V)	Water resistance
BLE15 USB-C	0.3	30	15	372	40	10	2	5	IP20
BLE15	0.3	30	15	372	30	10	2	5	IP20

LIO 20

20mm 5V electronic DC radio motor USB-C

Outgoing - replacement is BLEM20



- Electronic limit setting
- Built-in receiver
- 5V DC with built-in Lithium battery
- Low energy consumption
- Dot-move function
- Third limit
- Automatic power off switch
- Especially for 32mm tube

TECHNICAL SPECIFICATIONS

Order code	Torque (Nm)	Speed (rpm)	Diameter (mm)	Motor Length (mm)	Cable Length (cm)	Power (W)	Current (A)	Tension (V)	Water resistance
BLE20	0.5	28	20	485	X	10	2	5	IP20

LIO 25

25mm 5V electronic DC radio motor USB-C

Outgoing - replacement is BLEM25



- Electronic limit setting
- Built-in receiver
- 5V DC with built-in Lithium battery
- Low energy consumption
- Dot-move function
- Third limit
- Automatic power off switch

TECHNICAL SPECIFICATIONS

Order code	Torque (Nm)	Speed (rpm)	Diameter (mm)	Motor Length (mm)	Cable Length (cm)	Power (W)	Current (A)	Tension (V)	Water resistance
BLE25	1.1	28	25	500	X	10	2	5	IP20

LIO 28

28mm 5V electronic DC radio motor USB-C extra quiet



- Electronic limit setting
- Built-in receiver
- 5V DC with built-in Lithium battery
- Low energy consumption
- Dot-move function
- Third limit
- Automatic power off switch
- Extra quiet (54 db)

TECHNICAL SPECIFICATIONS

Order code	Torque (Nm)	Speed (rpm)	Diameter (mm)	Motor Length (mm)	Cable Length (cm)	Power (W)	Current (A)	Tension (V)	Water resistance
BLEQ28	2	28	28	670	X	22	1.60	5	IP20

LIO 35

35mm 5V electronic DC radio motor USB-C extra quiet

Outgoing - replacement is BLEMQ35-06



- Electronic limit setting
- Built-in receiver
- 5V DC with built-in Lithium battery
- Low energy consumption
- Dot-move function
- Third limit
- Automatic power off switch
- Extra quiet (54 db)

TECHNICAL SPECIFICATIONS

Order code	Torque (Nm)	Speed (rpm)	Diameter (mm)	Motor Length (mm)	Cable Length (cm)	Power (W)	Current (A)	Tension (V)	Water resistance
BLEQ35-6	6	24	35	694	15	38	3.23	5	IP20

LIO 35

35mm 5V electronic DC radio motor USB-C

Outgoing - replacement is BLEMQ35-13



- Electronic limit setting
- Built-in receiver
- 5V DC with built-in Lithium battery
- Low energy consumption
- Dot-move function
- Third limit
- Automatic power off switch

TECHNICAL SPECIFICATIONS

Order code	Torque (Nm)	Speed (rpm)	Diameter (mm)	Motor Length (mm)	Cable Length (cm)	Power (W)	Current (A)	Tension (V)	Water resistance
BLE35-13 USB-C	13	11	35	690	15	38	3.23	5	IP20

VESTA 25

25mm 230V electronic radio motor



- Electronic limit setting
- Built-in receiver
- 230V AC (2 wires)
- Extra powerfull motor
- Dot-move function
- Third limit
- Automatic power off switch

TECHNICAL SPECIFICATIONS

Order code	Torque (Nm)	Speed (rpm)	Diameter (mm)	Motor Length (mm)	Cable Length (cm)	Power (W)	Current (A)	Tension (V)	Water resistance
BPE25DD	1.5	32	25	485	500	8	0.63	110-230	IP20

VESTA 28

28mm 230V electronic radio motor extra quiet



- Electronic limit setting
- Built-in receiver
- 230V AC (2 wires)
- Low energy consumption
- Dot-move function
- Third limit
- Automatic power off switch
- Extra quiet (54 db)

TECHNICAL SPECIFICATIONS

Order code	Torque (Nm)	Speed (rpm)	Diameter (mm)	Motor Length (mm)	Cable Length (cm)	Power (W)	Current (A)	Tension (V)	Water resistance
BPEQ28DD	2	28	28	645	500	18	1.0	110-230	IP20

NINO 25

25mm 230V electronic radio motor

Outgoing - replacement is BPE25DD with removable wires



- Electronic limit setting
- Built-in receiver
- 230V AC
- Extra powerful motor
- Dot-move function
- Third limit
- Automatic power off switch

TECHNICAL SPECIFICATIONS

Order code	Torque (Nm)	Speed (rpm)	Diameter (mm)	Motor Length (mm)	Cable Length (cm)	Power (W)	Current (A)	Tension (V)	Water resistance
BPE25	1.5	32	25	485	500	8	0.63	110-230	IP20

NINO 35

35mm 230V electronic radio motor extra quiet

Outgoing - replacement is BEMQ35-06



- Electronic limit setting
- Built-in receiver
- 230V AC
- Low energy consumption
- Dot-move function
- Third limit
- Automatic power off switch
- Extra quiet (54 db)

TECHNICAL SPECIFICATIONS

Order code	Torque (Nm)	Speed (rpm)	Diameter (mm)	Motor Length (mm)	Cable Length (cm)	Power (W)	Current (A)	Tension (V)	Water resistance
BEQ35-06	6	28	35	580	500	144	0.63	110-230	IP44

EZIO 25

25mm 230V standard motor



- Electronic limit setting
- 230V AC (2 wires)
- Parallel switching
- Max. 90 per 16A fuse

TECHNICAL SPECIFICATIONS

Order code	Torque (Nm)	Speed (rpm)	Diameter (mm)	Motor Length (mm)	Cable Length (cm)	Power (W)	Current (A)	Tension (V)	Water resistance
MS25	1.5	32	25	445	200	13	0.15	110-230	IP20

EZIO 25

25mm 24V DC standard motor extra short



- Mechanic limit setting
- 24V AC
- Min. Tube diameter 35mm

TECHNICAL SPECIFICATIONS

Order code	Torque (Nm)	Speed (rpm)	Diameter (mm)	Motor Length (mm)	Cable Length (cm)	Power (W)	Current (A)	Tension (V)	Water resistance
MDS25	0.7	34	25	325	200	10	0.4	24	IP20

EZIO 35

35mm 230V standard motor extra quiet



- Mechanic limit setting
- 230V AC

- Extra quiet (54 db)

TECHNICAL SPECIFICATIONS

Order code	Torque (Nm)	Speed (rpm)	Diameter (mm)	Motor Length (mm)	Cable Length (cm)	Power (W)	Current (A)	Tension (V)	Water resistance
MBQ35-06	6	28	35	512	300	121	0.53	230	IP44
MBQ35-10	10	17	35	512	300	121	0.53	230	IP44

MATTER BY BREL

The technological development on connectivity



The language that makes all devices talk to each other

Many technical developments are currently underway regarding the connectivity of motors for in shading systems. BREL HOME keeps a close eye on these developments and applies them in our BREL HOME products as soon as they are realistic and workable. In the coming period, BREL HOME will integrate two innovations into its product range.

Matter is much talked about. But what is it really? Many people think Matter is some kind of home automation system, home control. It isn't. It is, however, a way to connect between a product and your phone. Whether you are at home or not. Matter is a language that allows all devices to talk to each other via Amazon's Alexa, Apple Homekit or Google Home



What does Matter mean to BREL HOME

It is an ideal connection for indoor blinds because the wireless connection works well indoors. The integration of Matter into our indoor blinds products has begun, with the first products being ready in early 2024.

For outdoor blinds, remote control connection is still the best option because the radio signal is much stronger than a Matter signal.

HOW DOES MATTER WORK

Matter by BREL

Bi-directional



Matter by BREL app



Wifi router

Matter motor

Wifi connector with Matter

See p.55

Works with
Apple Home

works with
Google Home

Smart Eco System

 **SmartThings**

works with
alexa

HOW DOES MATTER WORK

Your Smart Home with Matter



Wifi connector with Matter

■ Wifi router	■ Amazon Eero
■ Smartphones	■ SmartThings Hub
■ Google Nest Hub	■ SmartThings Station
■ Google Nest Wifi	■ Aeotec Smart Home
■ Apple Home pod	■ Eve Home
■ Apple TV	■ Philips One Tv
■ Amazon Echo Dot	■ Samsung Tv

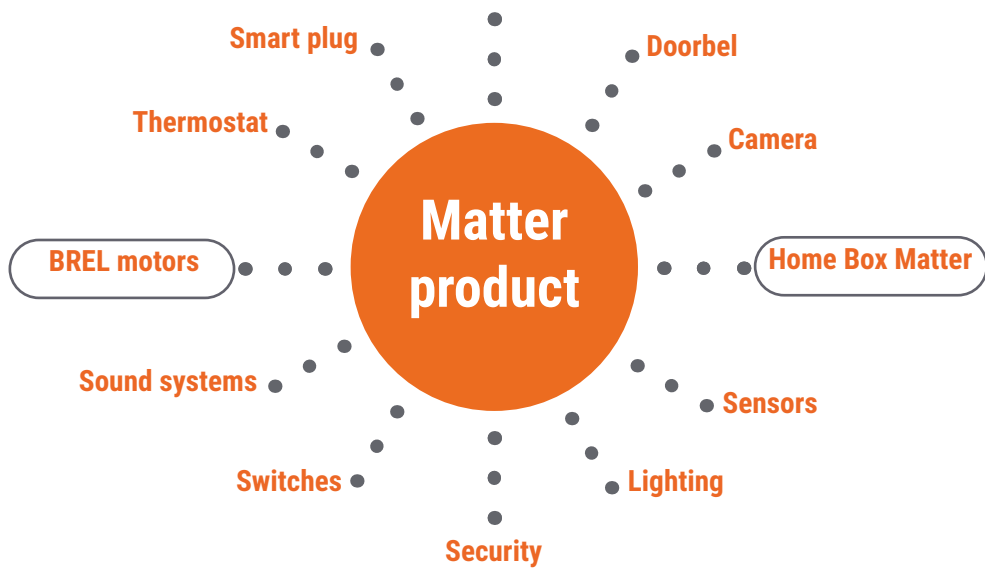



24mm 12V electronic DC radio motor single shaft



- Electronic limit setting
- Built-in receiver
- Dot-move function
- Third limit
- Automatic power off switch
- Backlash compensation for axis
- Theoretical runtime motor, fully charged battery (650 ~ 950 Mah) and maximum power: 90 min
- Theoretical runtime motor, fully charged battery (2000 ~2600 Mah) and maximum power: 200 min

TECHNICAL SPECIFICATIONS

Order code	Torque (Nm)	Speed (rpm)	Diameter (mm)	Motor Length (mm)	Cable Length (cm)	Power (W)	Current (A)	Tension (V)	Water resistance
BJEM24S	0.6	34	24	129	30	8	1.00	12	IP20



24mm 12V electronic DC radio motor single shaft



- Electronic limit setting
- Built-in receiver
- Dot-move function
- Third limit
- Automatic power off switch
- Backlash compensation for axis
- Theoretical runtime motor, fully charged battery (650 ~ 950 Mah) and maximum power: 60 min
- Theoretical runtime motor, fully charged battery (2000 ~2600 Mah) and maximum power: 150 min

TECHNICAL SPECIFICATIONS

Order code	Torque (Nm)	Speed (rpm)	Diameter (mm)	Motor Length (mm)	Cable Length (cm)	Power (W)	Current (A)	Tension (V)	Water resistance
BJEM24D	0.8	34	24	190	30	14	1.18	12	IP20

MATTER 20



20mm 5V electronic DC radio motor USB-C



- Electronic limit setting
- Built-in receiver
- 5V DC with built-in Lithium battery
- Low energy consumption
- Dot-move function
- Third limit
- Automatic power off switch
- Especially for 32mm tube

TECHNICAL SPECIFICATIONS

Order code	Torque (Nm)	Speed (rpm)	Diameter (mm)	Motor Length (mm)	Cable Length (cm)	Power (W)	Current (A)	Tension (V)	Water resistance
BLEM20	0.5	28	20	485	X	10	2	5	IP20

MATTER 25



25mm 5V electronic DC radio motor USB-C



- Electronic limit setting
- Built-in receiver
- 5V DC with built-in Lithium battery
- Low energy consumption
- Dot-move function
- Third limit
- Automatic power off switch

TECHNICAL SPECIFICATIONS

Order code	Torque (Nm)	Speed (rpm)	Diameter (mm)	Motor Length (mm)	Cable Length (cm)	Power (W)	Current (A)	Tension (V)	Water resistance
BLEM25	1.1	28	25	500	X	10	2	5	IP20

MATTER 35



35mm 5V electronic DC radio motor USB-C extra quiet



- Electronic limit setting
- Built-in receiver
- 5V DC with built-in Lithium battery
- Low energy consumption
- Dot-move function
- Third limit
- Automatic power off switch
- Extra quiet (54 db)

TECHNICAL SPECIFICATIONS

Order code	Torque (Nm)	Speed (rpm)	Diameter (mm)	Motor Length (mm)	Cable Length (cm)	Power (W)	Current (A)	Tension (V)	Water resistance
BLEMQ35-6	6	24	35	694	15	38	3.23	5	IP20
BLEMQ35-13	13	11	35	690	15	38	3.23	5	IP20

MATTER 35



35mm 230V electronic radio motor extra quiet



- Electronic limit setting
- Built-in receiver
- 230V AC
- Low energy consumption
- Dot-move function
- Third limit
- Automatic power off switch
- Extra quiet (54 db)

TECHNICAL SPECIFICATIONS

Order code	Torque (Nm)	Speed (rpm)	Diameter (mm)	Motor Length (mm)	Cable Length (cm)	Power (W)	Current (A)	Tension (V)	Water resistance
BEMQ35-06	6	28	35	580	500	144	0.63	110-230	IP44
BEMQ35-10	10	17	35	580	500	144	0.63	230	IP44

ACCESSORIES

Product	Description	Order code
	<p>USB Cable with magnet 300 cm</p>	<p>Z-42-300M</p>
	<p>Magnetic plug Micro USB</p>	<p>Z-42-01</p>
	<p>Magnetic plug USB-C</p>	<p>Z-42-02</p>
	<p>Charger 12V EU</p>	<p>DC-220</p>
	<p>Charger 12V UK</p>	<p>DC-221</p>
	<p>Solar panel with USB-C without housing 570 x 30 x 2.5mm</p>	<p>NC-4090</p>



ADAPTION

Product	Description	Order code
	Adaption tube 8K40 35mm motor A8K40-35	A8K40-35C + A8K40-35W
	Adaption tube 41 35mm motor A41-35	A41-35C + A41-35W
	Adaption tube 50 35mm motor A50-45	A50-45C + A50-45W
	Adaption 35mm motor to 45mm tube	V35-45
	Adaption tube 8K50 45mm motor A8K50-45	A8K50-45C + A8K50-45
	Adaption tube 8K60/63 45mm motor A8K60/63-45	A8K60/63-45C + A8K60/63-45W
	Adaption tube 63 45mm motor A63-45	A63-45C + A63-45W

OTHER

Product	Description	Order code
	<p>Motorbracket round 35mm motor for venetian blinds</p>	<p>BP-52</p>
	<p>Motorbracket square 35mm motor for venetian blinds</p>	<p>BP-52-2</p>
	<p>Conus for tube 8K40</p>	<p>VC-W1</p>
	<p>Container tube holder round 50mm White</p>	<p>VC-W2W</p>
	<p>Container tube holder round 50mm Grey</p>	<p>VC-W2G</p>
	<p>Container tube holder round 50mm Black</p>	<p>VC-W2B</p>
	<p>Tube plug with shaft for tube 8K40</p>	<p>VP-8K40</p>
	<p>Clip for 35mm and 45mm motor</p>	<p>Z-55</p>

OTHER

Product	Description	Order code
	Clip for 16mm and 25mm motor	Z-56
	Shaft for 25mm motor	Z-57

ADAPTION BENTHIN

Tube	15mm motor	20mm motor	25mm motor	28mm motor	35mm motor
alu 20	ABB20-15				
alu 20R	ABBR20R-15				
alu 29	ABB29-15	ABB29-22	ABB29-25		
alu 29R	ABBR29R-15	ABBR29R-22	ABBR29R-25		
alu 32		ABB32-22	ABB32-25		
alu 38		ABB38-22	ABB38-25	ABB38-28	
alu 43			ABB43-25	ABB43-28	
alu 44			ABB44-25	ABB44-28	ABB44-35
alu 52			ABB52-25	ABB52-28	ABB52-35
alu 65 SL				ABB65S-28	ABB65S-35
alu 65				ABB65-28	ABB65-35
Motorbracket	BRS-25M	BRS-22	BRS-25	BRS-28	BRS-35

ADAPTION HUNTER DOUGLAS

Tube	15mm motor	20mm motor	25mm motor	28mm motor	35mm motor
staal 32.6	AHD32-15	AHD32-20	AHD32-25		
staal 36.9		AHD38-20	AHD38-25	AHD38-28	
staal 34.2		AHD34-20	AHD34-25		
staal 40.2			AHD40-25	AHD40-28	
staal 53.2			AHD50-25	AHD50-28	AHD53-25
Motorbracket	BRS-25	BRS-22	BRS-25	BRS-28	BRS-35

ADAPTION COULISSE

Tube	15mm motor	20mm motor	25mm motor	28mm motor	35mm motor
alu 25	ACC25-15	ACC25-22			
alu 28	ACC28-15	ACC28-22	ACC28-25		
alu 30	ACC30-15	ACC30-22	ACC30-25		
alu 35		ACC35-22	ACC35-25		
alu 38		ACC38-22	ACC38-25	ACC38-28	
alu 42		ACC42-22	ACC42-25	ACC42-28	ACC42-35
alu 50			ACC50-25	ACC50-28	ACC50-35
alu 65				ACC65-28	ACC65-35
alu 80				ACC80-28	ACC80-35
Motorbracket	BRCCA-25	BRCCA-22	BRCCA-25	BRCCA-28	BRCCA-35

ADAPTION LOUVOLITE

Tube	15mm motor	20mm motor	25mm motor	28mm motor	Motorbracket
alu 32	AL032-15	AL032-20	AL032-25		BRL-32
alu 35		AL035-20	AL035-25		BRL-40
alu 40		AL040-20	AL040-25	AL040-28	BRL-45
alu 45-2L			AL045-25	AL045-28	BRL-45
alu 45-3L			AL045S-25	AL045S-28	

ADAPTION DECORA

Tube	15mm motor	20mm motor	25mm motor	28mm motor	Motorbracket
Tube 32	ALO32-15	ALO32-22	ALO32-25		BRL-32
Tube 40		ALO40-22	ALO40-25	ALO40-28	BRL-40
Tube 45-2			ALO45-2-25	ALO45-2-28	BRL-45
Tube 45-3			ALO45-3-25	ALO45-3-28	BRL-45

ADAPTION VAKO

Tube	15mm motor	20mm motor	25mm motor	28mm motor	35mm motor
alu 25	AVA25-15	AVA25-20			
alu 38		AVA38-20	AVA35-25	AVA38-28	
alu 43			AVA43-25	AVA43-28	
alu 44			AVA44-25	AVA44-28	AVA44-35
alu 50				AVA50-28	AVA50-35
Motorbracket	BRCCA-25	BRCCA-22	BRCCA-25	BRCCA-28	BRCCA-35

ADAPTION BAYAR

Tube	15mm motor	20mm motor	25mm motor	28mm motor	35mm motor
Tube 38	ABA38-15	ABA38-22	ABA38-25	ABA38-28	
Tube 40	ABA38-15	ABA40-22	ABA40-25	ABA40-25	
Motorbracket	BRS-25	BRS-22	BRS-25	BRS-28	BRS-35

CURTAINTRACK MOTORS

Opening and closing curtains



Bring the future into your home

Electrically operating curtains is the future for your home. Electric curtain rails are perfect for hard-to-reach or heavy curtains. With the BREL HOME solutions you can also ensure that the curtains open and close automatically during holidays.

Standard track

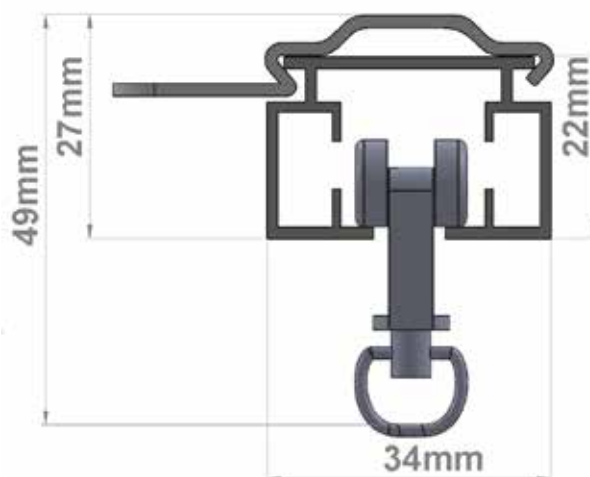

Radio motor

BREL HOME has 3 types of radio motors for curtains. Unique to the BG-980 is that this motor is equipped with a **WiFi** function, allowing the motor to be linked directly to the app.

Standard motor

BREL HOME has 1 standard motor for curtains in its range. This standard 230V motor is especially for projects. Thanks to the Dry Contact input, all motors can easily be connected to a home automation system.

LUNA

12V electronic DC radio curtain motor



- Automatic limit setting
- Built-in receiver
- Third limit
- Automatic power off switch
- Stall protection
- Manual override
- Pluggable Lithium battery pack
- Dry Contact input

TECHNICAL SPECIFICATIONS

Order code	Torque (Nm)	Speed (rpm)	Diameter (mm)	Motor Length (mm)	Cable Length (cm)	Power (W)	Current (A)	Tension (V)	Water resistance
BGLE-980	1.2	20	40	430	X	16	1.0	14.8	IP40

LUNA

230V electronic radio curtain motor with WiFi



- Automatic limit setting
- Built-in receiver
- Third limit
- Automatic power off switch
- Stall protection
- Manual override
- Dry Contact input
- WiFi function

TECHNICAL SPECIFICATIONS

Order code	Torque (Nm)	Speed (rpm)	Diameter (mm)	Motor Length (mm)	Cable Length (cm)	Power (W)	Current (A)	Tension (V)	Water resistance
BG-980	1.2	14	50	450	500	13	0.14	110-240	IP40

LUNA

230V electronic radio curtain motor



- Automatic limit setting
- Built-in receiver
- Stall protection
- Manual override
- Dry Contact input

TECHNICAL SPECIFICATIONS

Order code	Torque (Nm)	Speed (rpm)	Diameter (mm)	Motor Length (mm)	Cable Length (cm)	Power (W)	Current (A)	Tension (V)	Water resistance
BG-45	0.8	20	70	245	500	45	0.23	230	IP40

LUNA

230V standard curtain motor



- Electronic limit setting
- 230V AC
- Automatic power off switch
- For switch or Home automation
- Especially for projects

TECHNICAL SPECIFICATIONS

Order code	Torque (Nm)	Speed (rpm)	Diameter (mm)	Motor Length (mm)	Cable Length (cm)	Power (W)	Current (A)	Tension (V)	Water resistance
MGS-45	0.8	20	70	245	500	45	0.23	230	IP40

ACCESSORIES

Product	Description	Order code
	Curtain rail 6m	G-01
	Belt per 100m	G-02
	1e runner	G-03
	Runner 12,6mm	G-10
	Wave-runner 60mm	G-17
	Wave-runner 80mm	G-18
	Wall bracket	G-07
	Ceilingclip S-Track	G-15

ACCESSORIES

Product	Description	Order code
	Component set BG-45 and MGS-45	G-04
	Component set horizontal right BG-980 and BGLE-980	G-22-R
	Component set horizontal left BG-980 and BGLE-980	G-22-L
	Component set vertical BG-980 and BGLE-980	G-23
	Charger 12V EU male with DIN plug male for BGLE-980 300 cm cable length	DC-216
	Charger 12V UK male with DIN plug male for BGLE-980 300 cm cable length	DC-217
	Cable for Domotica RJ11 plug	G-09
	Solar panel with XL DIN plug BGLE-980	DC-1289G



PROJECT BLINDS

Potential-free switching

74

Project motors

75



POTENTIAL-FREE SWITCHING

Motors for project sun blinds



Specially for home automation systems

BREL HOME supplies smart motors that are extremely suitable for projects, thanks to a potential-free circuit. The **Vesta** series includes motors with potential-free switching. The 230 volt motors have an extra cable that can be connected directly to the existing building management system. So no additional control such as relay boxes or dry-contact transmitters are required. In addition, the motors have their own built-in receiver and can also be operated with a transmitter. The final distance settings are easily made via the bi-directional protocol. The project motors can be connected directly to the control system.

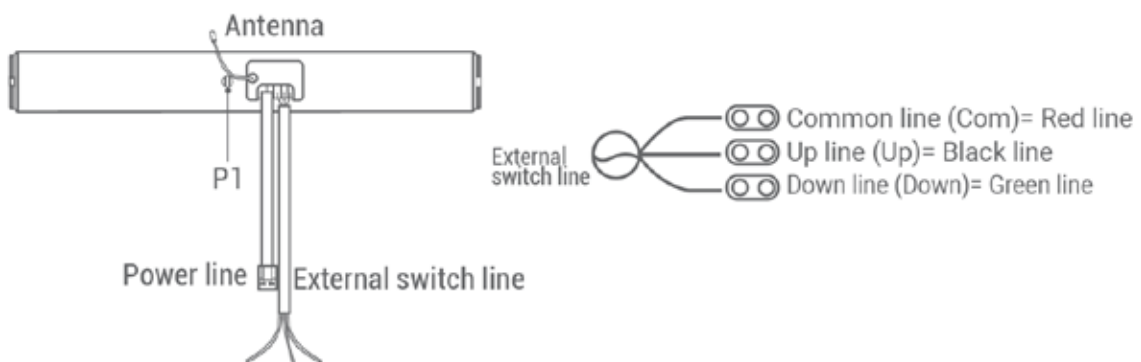

Examples Home automation system:

- KNX
- Loxone
- Fibaro
- Busch-Jaeger
- ABB
- Schneider Electric
- BR Controls

More information?

Would you like to know more about potential-free switching or would you like advice for your project? Send an email to sales@brel-home.com. You will then receive tailor-made advice and possibly receive a matching quote for the project.

And all other home automation systems

VESTA 24

24mm 12V electronic radio motor double shaft



- Electronic limit setting
- Built-in receiver
- Dot-move function
- Third limit
- Automatic power off switch
- Potential-free switching
- Backlash compensation for axis
- Theoretical runtime motor, fully charged battery (DC-1330) and maximum power: 60 min
- Theoretical runtime motor, fully charged battery (DC-1277) and maximum power: 180 min

TECHNICAL SPECIFICATIONS

Order code	Torque (Nm)	Speed (rpm)	Diameter (mm)	Motor Length (mm)	Cable Length (cm)	Power (W)	Current (A)	Tension (V)	Water resistance
BJE24DD	0.8	34	24	190	30	14	1.18	12	IP20

VESTA 25

25mm 230V electronic radio motor



- Electronic limit setting
- Built-in receiver
- 230V AC
- Extra powerfull motor
- Potential-free switching
- Dot-move function
- Third limit
- Automatic power off switch

TECHNICAL SPECIFICATIONS

Order code	Torque (Nm)	Speed (rpm)	Diameter (mm)	Motor Length (mm)	Cable Length (cm)	Power (W)	Current (A)	Tension (V)	Water resistance
BPE25DD	1.5	32	25	485	500	8	0.63	110-230	IP20

VESTA 28

28mm 230V electronic radio motor extra quiet



- Electronic limit setting
- Built-in receiver
- 230V AC
- Potential-free switching
- Dot-move function
- Third limit
- Extra quiet (54 db)

TECHNICAL SPECIFICATIONS

Order code	Torque (Nm)	Speed (rpm)	Diameter (mm)	Motor Length (mm)	Cable Length (cm)	Power (W)	Current (A)	Tension (V)	Water resistance
BPEQ28DD	2	28	28	645	500	18	1.0	110-230	IP20

VESTA 35

35 mm 230V electronic radio motor



- Electronic limit setting
- Built-in receiver
- 230V AC
- Potential-free switching
- Dot-move function
- Third limit
- Extra quiet (54 db)

TECHNICAL SPECIFICATIONS

Order code	Torque (Nm)	Speed (rpm)	Diameter (mm)	Motor Length (mm)	Cable Length (cm)	Power (W)	Current (A)	Tension (V)	Water resistance
BEQ35DD	10	17	35	580	500	144	0.63	230	IP44

CURTAIN RAIL MOTORS



The Luna curtain rail motors in BREL HOME's range are all suitable for projects. The smart motors have a dry contact connection that, in combination with an RJ11 plug (G-09), allows you to connect the motor to home automation or building management systems. The standard curtain rail motor can be controlled directly with a home automation or building management system.

TECHNICAL SPECIFICATIONS

Order code	Torque (Nm)	Speed (rpm)	Diameter (mm)	Motor Length (mm)	Cable Length (cm)	Power (W)	Current (A)	Tension (V)	Water resistance
BGLE-980	1.2	20	40	430	X	16	1.0	14.8	IP40
BG-980	1.2	14	50	450	500	13	0.14	110-240	IP40
BG-45	0.8	20	70	245	500	45	0.23	230	IP40
MGS-45	0.8	20	70	245	500	45	0.23	230	IP40

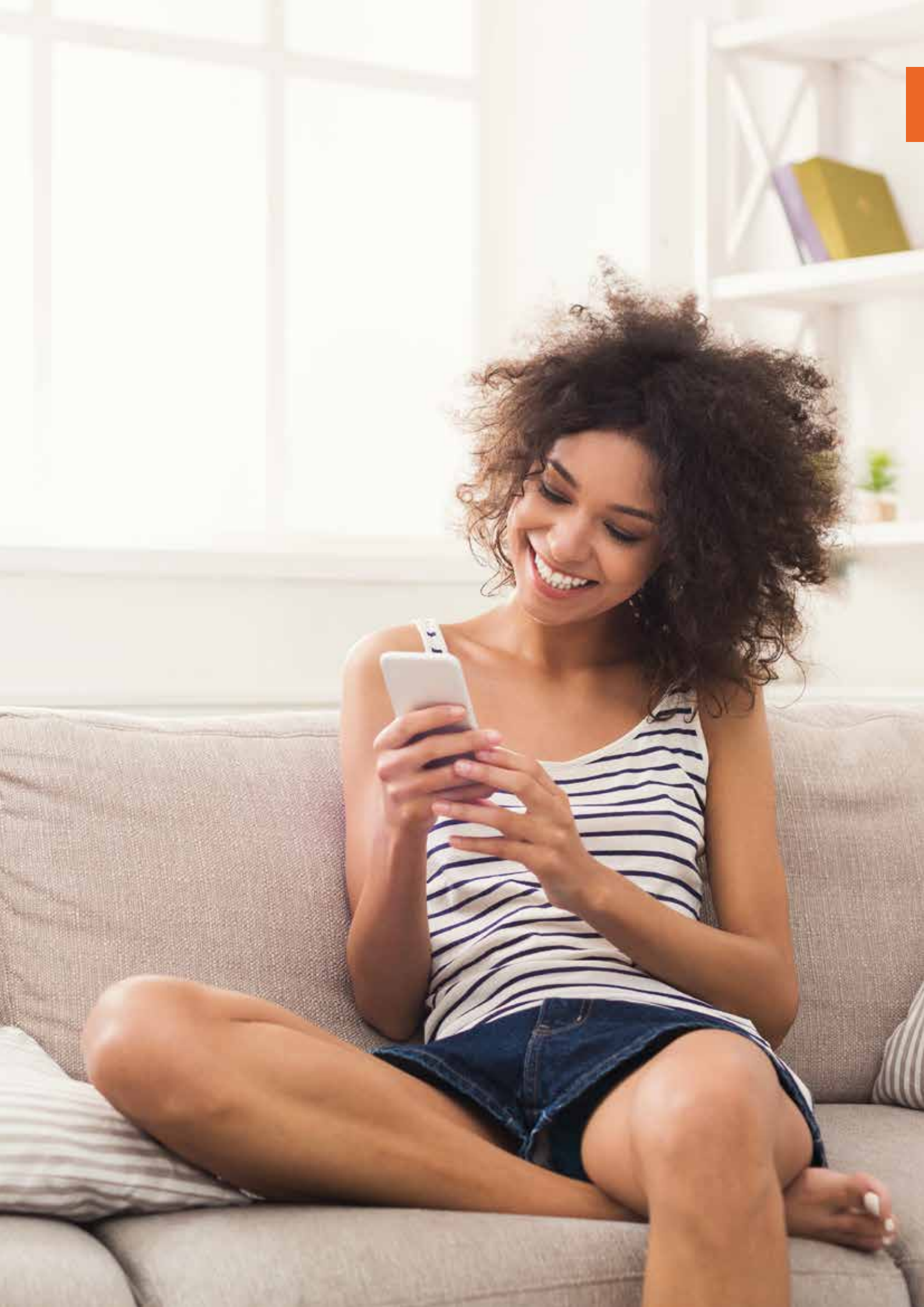

SMART HOME

BREL HOME app

80



Domotica systems

82



BREL HOME APP

The control of BREL HOME

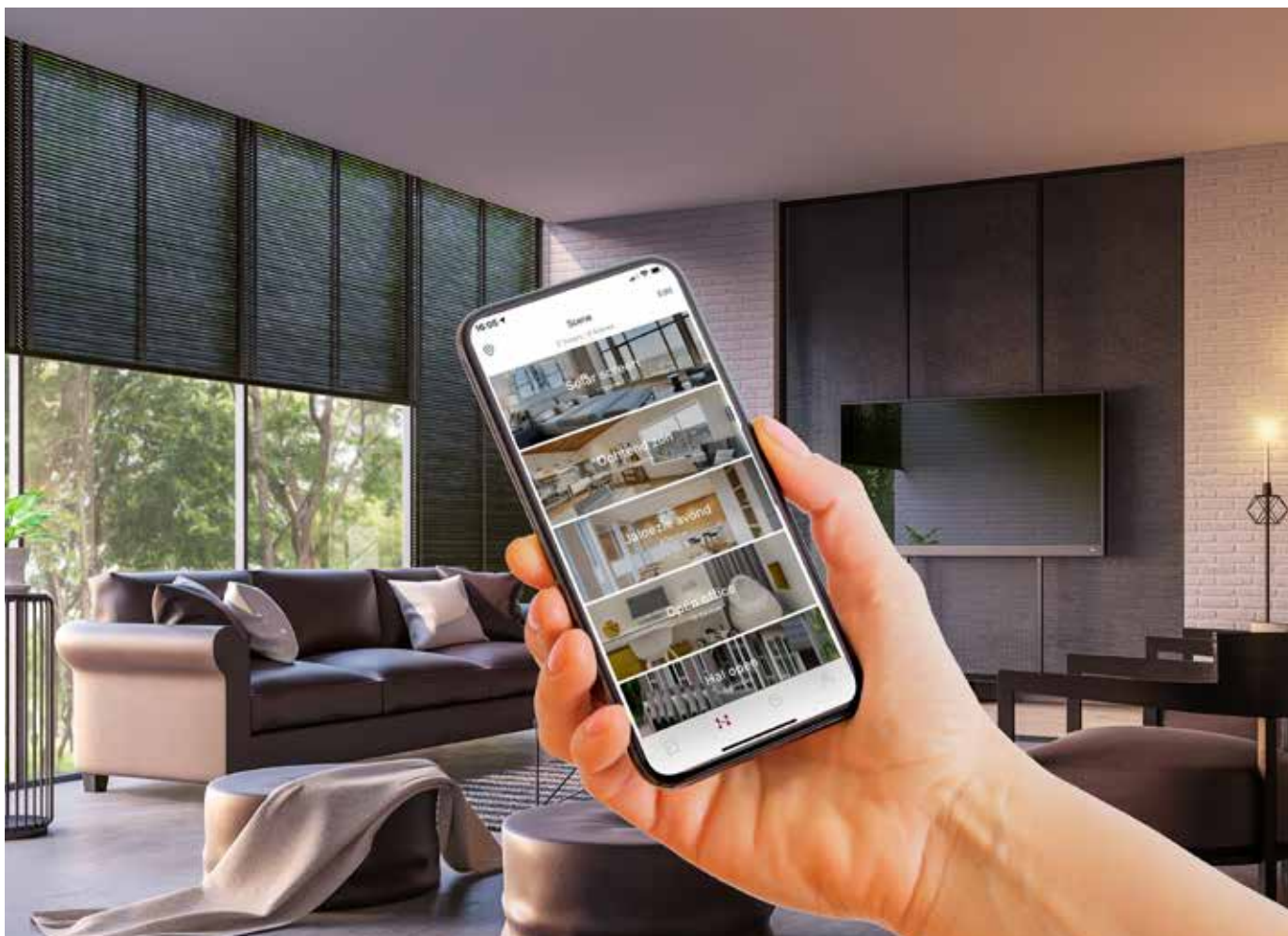

Smart and comfortable!

Anyone who chooses BREL HOME goes for ease of use: one app for controlling all products that contain a BREL smart motor. With the BREL HOME App, up to 30 motors can be controlled per hub. 5 hubs can be linked to your account. The BREL HOME Hub connects to the WiFi network and sends and receives signals to and from the motor, making operation with the app possible. This connection allows the motor to be operated at any time and from any location.

Home Box Mini

The Home Box mini is a compact USB WiFi hub. Easy to install via Bluetooth. This hub is suitable for bi-directional motors.

Home Box Duo

The Home Box Duo is a WiFi hub with an RS485 connection. Easy to install via Bluetooth. This hub is suitable for mono- and bi-directional motors.

Home Box Ultra

The Home Box Duo is the latest WiFi hub. The hub has a LAN/UTP connection so that the hub can also be connected directly to the router. This hub is suitable for bi-directional motors.



BREL HOME APP

Connect your BREL HOME app to other Smart Home systems

Bi-directional



Standard

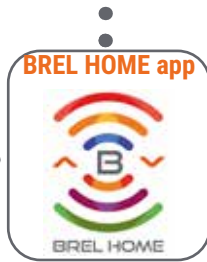

A collection of logos for compatible smart home systems: Amazon Alexa, Google Home, LOXONE, Homey, Home Assistant, and Siri.

Options in the BREL HOME app

The BREL HOME app not only makes it possible to control sun blinds remotely, but there are also many other options that you can set in the app:

- Timers
- Scenarios
- Voice control by Siri

HOME AUTOMATION SYSTEMS

BREL HOME motors for building management systems

Specially for home automation systems

BREL HOME supplies smart motors that are extremely suitable for projects, thanks to a potential-free circuit. The 230 volt motors have an extra cable that can be connected directly to the existing building management system. There are no additional controls such as relay boxes, so no additional dry-contact transmitter is required. In addition, the motors have their own built-in receiver and can also be operated with a transmitter. The final distance settings are easily made via the bi-directional protocol. In addition, the standard motors are also suitable for home automation systems.

Bi-directional



Dry Contract
DD-1149

Switch / relais
of the home automation system

Standard

Switch/ relais
of the home automation system



And all other Home Automation Systems

BREL SMART BUILDING

The new motor for projects

The pressure on office owners to become more sustainable is increasing. Because the deadline is approaching: by 2030, the Netherlands must emit 55 per cent less CO2 than in 1990. The government is already stepping up a gear with stricter rules, including the energy-saving obligation. Companies that consume more than 50,000 kWh of electricity or 25,000 m³ of gas per year, which is about 20 times more than the average household, must act.

Research shows that a key part of the solution is automatically controlled outdoor shading. It can even lead to an average energy saving of 19 per cent in offices in summer.

To address this problem, BREL MOTORS has come up with a new solution - BREL SMART BUILDING. A new brand, but based on the familiar Solar concept of BREL HOME.

With the advent of solar technology in project sun protection, BREL opens the door to a new era. With a specially developed app and software, scenarios are easily created, in all kinds of ways, at all levels of the organisation and at the desired decision levels.

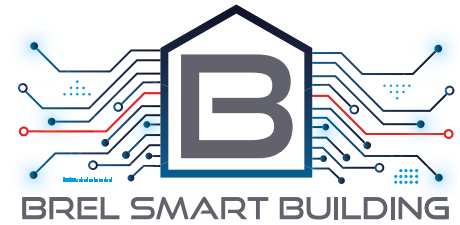

Exclusive partnership

BREL has entered into an exclusive partnership with Vodafone Smart Building. The motors software and hardware also already incorporate intelligence that anticipates the latest regulations regarding energy-efficient buildings. By linking Vodafone BREL SMART BUILDING and all other systems, office buildings can save energy even better while increasing user enjoyment.

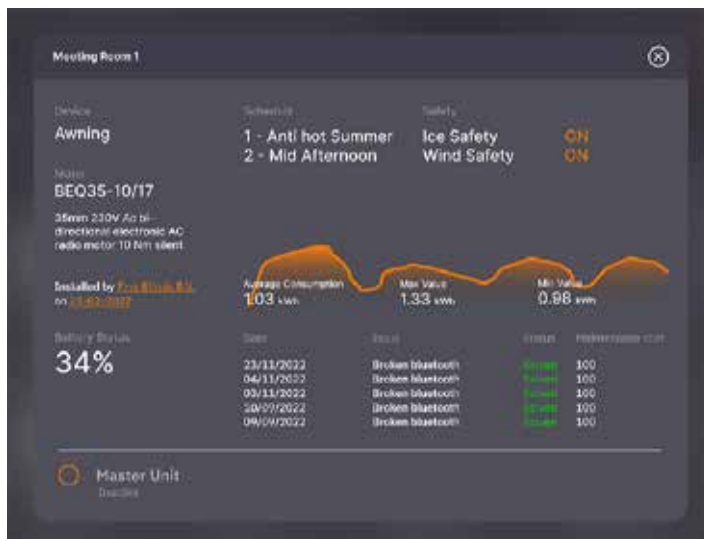

PENTA motors communicate Penta directional. This means that the motors communicate in five ways.

■ SIM card

With an integrated SIM card from Vodafone Business, the motor operates over the internet, receiving signals and transmitting data to the dashboard.

■ Bluetooth

It works via Bluetooth so the engine receives signals and sends the data to the dashboard.

■ Radio frequency

The motor receives signals via 433 MHz radio frequency which is sent from a remote control.

Would you like to know more about BREL SMART BUILDING?

Then send an email to info@brelsmartbuilding.com and we will get back to you as soon as possible.

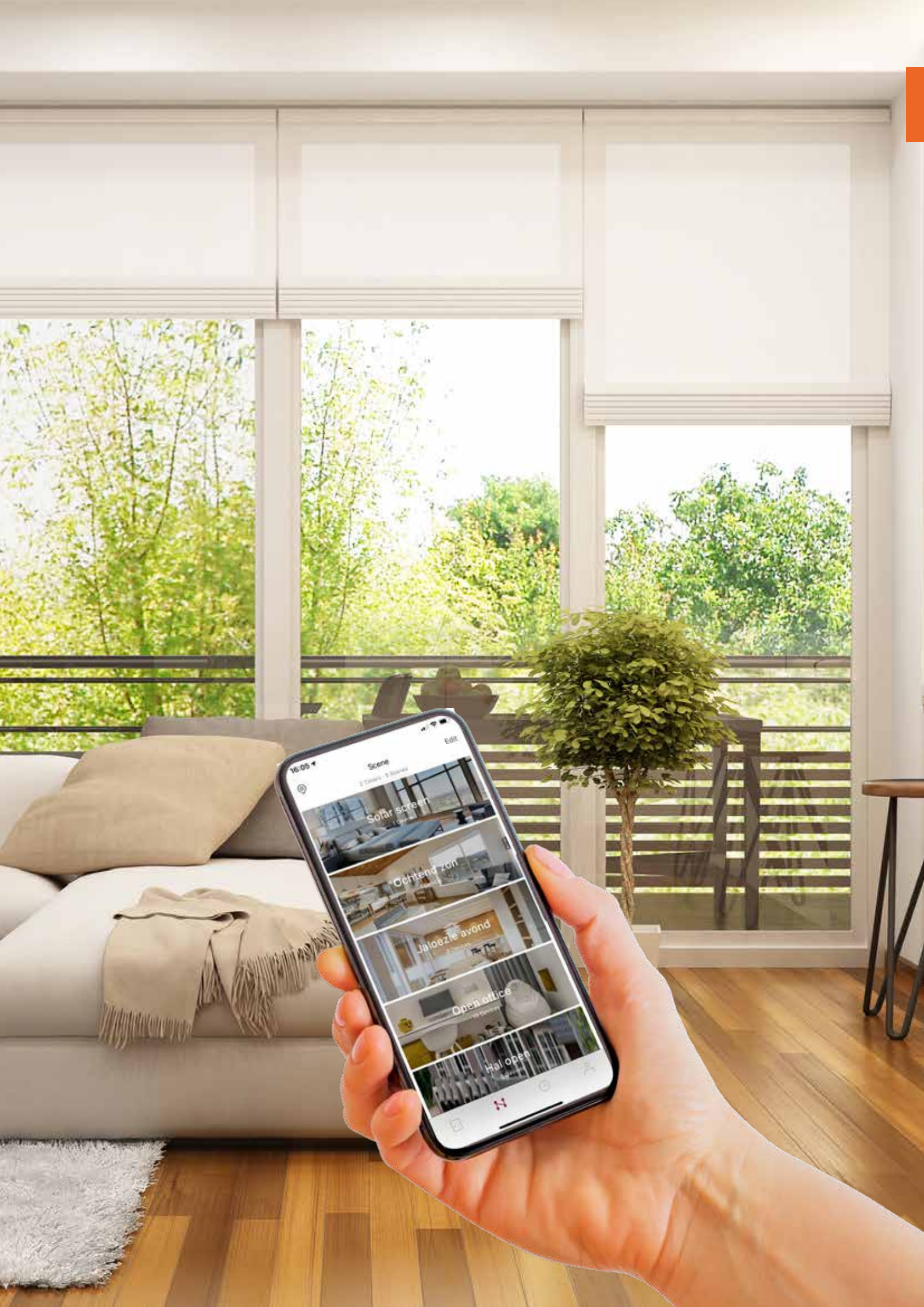

REMOTE CONTROLS



Home Box	86
Luxurious series	87
Standard series	90
Basic series	93
Other	94



HOME BOX

Product	Description	Order code
<p>New!</p> 	<p>Home Box Matter WiFi hub with Matter</p> <p>Works with the special BREL Matter app</p>	<p>HUB-04</p>
	<p>Home Box Mini USB WiFi hub bi-directional</p> <p>Works with the BREL HOME app</p>	<p>HUB-01</p>
	<p>Home Box Duo WiFi hub RS485 mono- and bi-directional</p> <p>Works with the BREL HOME app</p>	<p>HUB-02</p>
	<p>Home Box Ultra WiFi hub UTP/LAN & PoE mono- and bi-directional</p> <p>Works with the BREL HOME app</p>	<p>HUB-03</p>

LUXURIOUS WHITE

Product	Description	Order code
	<p>Luxurious White 1 channel</p>	<p>THW3001</p>
	<p>Luxurious White 15 channels</p>	<p>THW3015</p>
	<p>Luxurious White 15 channels TDBU & TR</p>	<p>THW3115</p>
	<p>Luxurious White 15 channels Curtaintrack</p>	<p>THW3215</p>



LUXURIOUS WHITE

Product	Description	Order code
 A white, rectangular wall switch with a single channel. It features a horizontal slot at the top and two toggle switches below it.	Luxurious White 1 channel Wall	TWW3001
 A white, rectangular wall switch with 15 channels. It features a large rectangular display screen at the top and a grid of 15 buttons below it.	Luxurious White 15 channels Wall	TWW3015



LUXURIOUS BLACK

Product	Description	Order code
	<p>Luxurious Black 1 channel</p>	<p>THB3001</p>
	<p>Luxurious Black 15 channels</p>	<p>THB3015</p>
	<p>Luxurious Black 15 channels TDBU & TR</p>	<p>THB3115</p>

STANDARD WHITE

Product	Description	Order code
	<p>Standard White 1 channel</p>	<p>THW2001</p>
	<p>Standard White 15 channels</p>	<p>THW2015</p>
	<p>Standard White 15 channels TDBU & TR</p>	<p>THW2115</p>
	<p>Standard White 15 channels Curtaintrack</p>	<p>THW2215</p>

STANDARD WHITE

Product	Description	Order code
	Standard White 1 channel Tilt & Lift	THW2501
	Standard White 15 channels Tilt & Lift	THW2515

STANDARD WHITE

Product	Description	Order code
	<p>Standard White 1 channel Wall</p>	<p>TWW2001</p>
	<p>Standard White 15 channels Wall</p>	<p>TWW2015</p>
<p><i>New!</i></p> 	<p>Standard White Scenario 6 channels Wall</p>	<p>TWW2606</p>



BASIC

Product	Description	Order code
	Basic White 1 channel	THW1001
	Basic White 5 channels	THW1005
	Basic Black Mini	TMB1001
	Basic White Mini	TMW2001

OTHER

Product	Description	Order code
	<p>Signal repeater USB 433.33 MHz</p>	<p>RB400</p>
	<p>Sun and wind meter Wireless</p>	<p>RW230</p>
	<p>Flush-mounted receiver for wall socket Bi-directional</p>	<p>RW100</p>
<p>New!</p> 	<p>Receiver for lighting Bi-directional</p>	<p>RW101</p>

OTHER

Product	Description	Order code
<p>New!</p> 	<p>Interior light sensor Bi-directioneel 60 x 60 x 20</p>	<p>RW231</p>
<p>New!</p> 	<p>Rotary switch cream white Bi-directioneel</p>	<p>SW020</p>
<p>New!</p> 	<p>Rotary switch white Bi-directional</p>	<p>SWU020</p>
	<p>Dry contact transmitter for Home automation systems Bi-directional</p>	<p>RW330</p>

Product	Description	Order code
	<p>Shocksensor Bi-directional</p>	<p>RW350</p>
<p>New!</p> 	<p>Everhome Hub cloudebox 4.0 Bi-directional</p> <p>Suitable for various protocols of sun protection motors</p>	<p>CBox 4.0</p>
	<p>Single receiver Mono-directional</p>	<p>DC-50</p>
	<p>Relay central control parallel switching</p>	<p>DC-209</p>

TRAINING

Stay informed of the latest developments



Knowledge is key!

With the right knowledge in-house, you can professionalize your company and serve your customers better. BREL HOME offers the opportunity to receive training at a company location. We train everyone who needs it: salespeople, technicians or technical service, everyone is welcome! A BREL HOME training takes a maximum of 1.5 hours, including half an hour of explanation about the motors and 1 hour of questions and answers regarding practical examples. BREL HOME offers a standard training, but the training can also be tailored specifically to your wishes.

Benefits of the training:

- Knowledge is up-to-date
- Expertise of BREL products
- Correct advice to the consumer
- Work more efficiently
- Problem-free deliveries
- Solve challenges easily
- Save time
- Increasing customer satisfaction

Request training

You can easily request a training course by sending an email to sales@brel-home.com. Please indicate the number of people and what you want training on.

Where?

Training can take place at a company location or at BREL HOME in the showroom.

PROMOTION

Sales material for your showroom



Complete your showroom with BREL

For promotion in your showroom, BREL HOME has various promotional materials that can support sales. BREL HOME offers the opportunity to furnish your showroom with BREL through a tailor-made starter package. In addition, various marketing materials are also available:

- Various brochures
- Display with brochures
- Smart Home brochure column
- Premium Dealer sticker (only for Premium Dealers)

Customized promotion

Do you need marketing material, but we don't offer it yet? Then get in touch with us. Then we can look at the possibilities together.

Do you want to know more?

Discuss the options with your contact person or send an email to marketing@brel-home.com.



WARRENTY

Extensively tested with a warranty of up to 5 years!

5 Jaar **garantie**
Year **warranty**

Tested thoroughly

BREL motors are developed according to our ideas and standards. In our factories, these products are very carefully assembled and checked on various points such as torque, sound, tension, final adjustments, brakes, etc. Our motors undergo a life cycle test of at least 10,000 cycles.



5 years warranty

Because the (Battery) motors have been extensively tested, we provide a 5-year warranty. Wear-sensitive parts such as remote controls, receivers and batteries have a 1-year warranty.



Terms and Conditions

Would you like to know more about warranty? Then read our general terms and conditions. You can find this at the back of the catalog or on our website www.brel-home.com

LOGISTICS

Large range of motors and accessories and fast delivery



Shipped with care

All orders are shipped from our warehouse in Doetinchem. Orders will be shipped depending on stock availability and your requested delivery date. Orders placed before 2:00 PM will be shipped the same day. Orders can be emailed to order@brel-home.com

Please contact us

Do you have questions about:

- Prices
- Current orders
- Invoices
- Inventory

Please contact us by telephone
0314-680448 or email to
order@brel-home.com

Shipping prices

Shipping within the Netherlands:

- Package from €8,75
- Pallet: €75,-
- From €1500,- Franco

Shipping within EU:

- Package from €17,50
- Pallet from €100,-

Shipping outside EU:

- Prices based on recalculation by weight and dimensions

Small order costs:

- €10 up to order value of €250



CUSTOMER SERVICE

User-friendly and easy to install



Easy installation in 4 simple steps

Thanks to the simple installation of the BREL motors, in principle any technician can install and program the products. However, it may happen that you encounter a challenge. BREL HOME's technical service is available every working day to answer your questions. In more than 90% of cases we can help you by telephone. A lot of information is also available on our website www.brel-home.com.



The technical department is at your service from Monday to Friday from 8:30 to 17:00. We are closed for lunch between 12:30 and 13:00.

Technical support by phone on 0314-680448 or email to support@brel-home.com

CALCULATION TOOL

How to calculate

Formula used:

$P \text{ (Nm)} = \text{Radius (mm)} \times G / 100 / (1-V)$ (G=Load in kg,
Radius in mm diameter tube/ 2 en V =Safety factor)

Formula:

$\text{Torque (Nm)} = \text{Radius (mm)} \times G \text{ (kg)} / 100 / (1-V)$

G = Load

V = safety factor = 30%

R= diameter tube

Torque (Nm)		0,3	0,5	0,6	0,8	1,1	1,5	2	3
Tube diameter (mm)	20	2,1	3,5	4,2	5,6				
	25	1,7	2,8	3,4	4,5				
	30	1,4	2,3	2,8	3,7	5,2	7,0		
	40		1,8	2,1	2,8	3,9	5,3	7,0	10
	50		1,4	1,7	2,3	3,1	4,2	5,6	8,4
	60					1,4	3,5	4,7	7,0
	70							4,0	6,0
	78								5,4
	85								
	100								
	100								
120									

CALCULATION TOOL

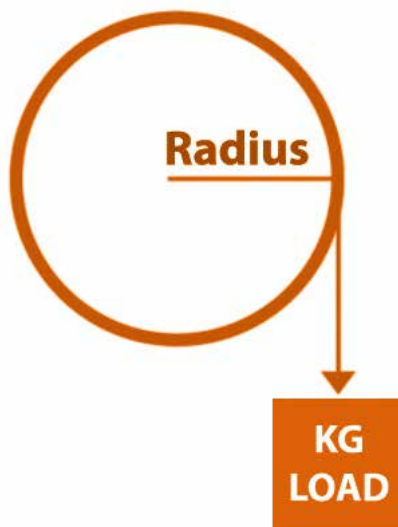

6	10	13	20	30	40	60	80	120	300
21	35	45,5							
16,8	28	36,4							
14	23,3	30,3	46,7	70	93,3				
12	20	26	40	60	80				
10,8	18	23	35,9	53,8	71,8	107,7	143,6	215,4	
						98,8	131,8	197,6	
						84	112	168	420
							101,8	152,7	381,8
							93,3	140	350

TERMS AND CONDITIONS

General Terms and Conditions Brel Nederland B.V. V2025-ENG-Nov-28th
The private company Brel Nederland B.V. (hereinafter: Brel Nederland) is registered with the Dutch Chamber of Commerce under number 51486873 and has its registered office at Voltastraat 86a (7006RW) in Doetinchem.

Article 1 - Definitions

1. In these general terms and conditions, the following definitions are used in the following sense, unless explicitly stated otherwise:
2. Offer: Any written offer to the Purchaser for the delivery of Products by the Seller to which these terms and conditions are inseparably linked.
3. Company: The natural or legal entity/person who practices a profession or operates a business.
4. Purchaser: The Company that enters into an Agreement (remotely) with the Seller.
5. Agreement: The sales agreement (entered into remotely) for the sale and delivery of Products bought by the Purchaser from Brel Nederland.
6. Products: The Products offered by Brel Nederland are motors and components for indoor and outdoor sun shades and related products, which include remote controls.
7. Seller: The provider of the Products to the Purchaser, hereinafter referred to as: Brel Nederland.

Article 2 - Applicability

1. These general terms and conditions apply to every Offer made by Brel Nederland and every Agreement between Brel Nederland and a Purchaser, and to every Product offered by Brel Nederland.
2. Before an agreement is entered into (remotely), the Purchaser shall be furnished with these general terms and conditions. If this is not reasonably possible, Brel Nederland shall inform the Purchaser as to how the General Terms and Conditions can be consulted, which will in any event be published on the website of Brel Nederland, so that the Purchaser can conveniently save these General Terms and Conditions on a permanent data medium.
3. In exceptional situations, exceptions to these general terms and conditions may be made if this has been explicitly agreed in writing with Brel Nederland.
4. These general terms and conditions also apply to any supplementary, amended or follow-up agreements with the Purchaser. Any eventual general and/or purchasing conditions set by the Purchaser will be rejected out of hand.
5. If one or more provisions of these general terms and conditions should be wholly or partially voided or annulled, the other provisions of these general terms and conditions shall remain in force and the voided or nullified provision(s) shall be replaced by a provision that has the same purport as the original provision.
6. Any ambiguities regarding the content, explanation or situations that have not been covered in these general terms and conditions must be assessed and clarified in accordance with the spirit of these general terms and conditions.
7. If these general terms and conditions refer to she/he, this should also be understood as a reference to he/she/they, if and insofar as applicable.

Article 3 - The Offer

1. All Offers made by Brel Nederland are non-binding, unless expressly stated otherwise in writing. If the Offer is limited or valid under specific conditions, this shall be expressly stated in the Offer. An Offer shall only be deemed valid once it has been confirmed in writing.
2. Brel Nederland shall submit the Offer by way of a price list. Brel Nederland shall only be bound by the Offer if this is accepted by the Purchaser in writing within the period of validity of the price list, or if the Purchaser has already paid the amount due. Nevertheless, Brel Nederland reserves the right to reject an

agreement with a potential Purchaser on the grounds of a justifiable reason for Brel Nederland.

3. The Offer contains an accurate description of the Product on offer together with the corresponding prices. The description is described in such detail as to enable the Purchaser to make a proper assessment of the Offer. Any obvious mistakes or errors in the Offer are not binding to Brel Nederland. Any images and specific data in the Offer only constitute an indication and cannot be grounds for any compensation or the dissolution of the (remote) Agreement. Brel Nederland cannot guarantee that the colours in the images correspond exactly to the actual colours of the Product.
4. Delivery times and deadlines stated in the Offer by Brel Nederland are indicative only, and if exceeded shall not entitle the Purchaser to the dissolution of the Agreement or to compensation, unless expressly agreed otherwise.
5. A combined quote does not obligate Brel Nederland to deliver part of the items included in the bid or Offer in exchange for part of the price quoted.

Article 4 - Conclusion of the Agreement

1. The agreement is concluded the moment the Purchaser has accepted an offer made by Brel Nederland by placing an order with Brel Nederland via email and Brel Nederland has confirmed this order.
2. An Offer can be made by Brel Nederland via a client-specific discount on the gross price list of Brel Nederland or via a client-specific net price.
3. If the terms of acceptance differ (on minor points) from the Offer, Brel Nederland is not bound by these terms.
4. Brel Nederland is not bound by an offer if the Purchaser might have in all reasonableness understood or ought to have understood that the offer clearly contains a mistake or an error in its wording. The Purchaser cannot claim any rights based on this mistake or error.
5. The right of withdrawal is not applicable to the Purchaser.
6. Products which cannot be returned (due to customisation and suchlike) are excluded from the right of withdrawal. This is explicitly stated in the Offer.
7. If the Offer from Brel Nederland is revised due to market circumstances, Brel Nederland has, in consultation, the right to revise or withdraw the Offer.

Article 5 - Execution of the Agreement

1. Brel Nederland will carry out the Agreement to the best of its professional judgement and ability.
2. If and insofar as required for the proper fulfilment of the agreement, Brel Nederland reserves the right to have specific work carried out by third parties at its own discretion.
3. The Purchaser will ensure that Brel Nederland is provided promptly with all the information that Brel Nederland has indicated is necessary, or that the Purchaser should understand within reason what is necessary for fulfilling the Agreement. If the information required for the fulfilment of the agreement is not provided to Brel Nederland in time, Brel Nederland reserves the right to suspend fulfilment of the agreement.
4. In fulfilling the agreement, Brel Nederland is under no obligation or liability to follow the instructions given by the Purchaser if this results in any change to the content or scope of the agreement. If the instructions lead to more work for Brel Nederland, the Purchaser is obligated to reimburse any additional or incidental incurred expenses accordingly.
5. Brel Nederland is entitled to request either a deposit or full payment in advance from the Purchaser before proceeding to fulfil the Agreement.
6. Brel Nederland shall not be held liable for any damage, irrespective of its nature, resulting from the fact that Brel Nederland acted on inaccurate and/or incomplete information provided by the Purchaser, unless Brel Nederland had been aware of this inaccuracy or incompleteness.

TERMS AND CONDITIONS

7. The Purchaser shall indemnify Brel Nederland against any claims made by third parties who incur damage attributable to the Purchaser in connection with the fulfilment of the agreement.

Article 6 - Delivery

1. If the commencement, progress or delivery of the agreement is delayed because, for instance, the Purchase has failed to provide all requested information or has failed to do so on time, or has failed to cooperate sufficiently, or if the advance/payment has not been received on time by Brel Nederland, or if there is any delay as a result of other circumstances beyond Brel Nederland's control, Brel Nederland reserves the right to extend the delivery period by a reasonable amount of time. All delivery deadlines agreed upon do not constitute fixed deadlines. The Purchaser must notify Brel Nederland in writing of any default on their part and allow Brel Nederland a reasonable time frame in order to be able to still fulfil its obligations. The Purchaser is not eligible for any compensation as a result of the delay.
2. The Purchaser is obligated to take delivery of the goods at the time they are made available to them in accordance with the Agreement, and also if they are offered to them earlier or later than agreed.
3. If the Purchaser refuses to take delivery or fails to provide information or instructions necessary for the delivery, Brel Nederland reserves the right to store the goods at the Purchaser's expense and risk.
4. If the Products are delivered by Brel Nederland or an external haulier, Brel Nederland is entitled, unless otherwise agreed in writing, to charge for delivery costs. These costs will be invoiced separately, unless expressly agreed otherwise.
5. If Brel Nederland needs information from the Purchaser for the purpose of fulfilling the agreement, the delivery period shall not commence until the Purchaser has provided Brel Nederland with all the information required for fulfilment of the agreement.
6. Any delivery period specified by Brel Nederland is intended to be indicative only. Longer delivery periods apply to deliveries outside of the Netherlands.
7. Brel Nederland reserves the right to deliver the goods in part shipments, unless this has been agreed otherwise or the partial delivery is not considered to have any independent value. Therefore, Brel Nederland is entitled to submit a separate invoice for the goods delivered in this way.
8. Brel Nederland can stipulate that delivery will only take place if all invoices have been paid, if there are well-founded concerns about the risk of non-payment.

Article 7 - Packaging and transport

1. In respect of the Purchaser, Brel Nederland undertakes to package the goods to be delivered properly and to secure them in such a way that they will reach their destination in good condition under normal conditions of handling.
2. Unless otherwise agreed in writing, all deliveries are to include Value Added Tax (VAT), including packaging and packaging materials.
3. Acceptance of goods without any notes or comments on the consignment form or on the receipt shall be considered proof that the packaging was in good condition at the time of delivery.

Article 8 - Inspections, claims

1. The Purchaser is obligated to inspect (or arrange to have inspected) the Products delivered at the time of delivery, but in any event, within 7 days of receipt of the Products, and only to unpack or use these insofar as is strictly necessary in order to be able to assess whether it holds the Product. In doing so, the Purchaser should check whether the quality and quantity of the goods delivered is in accordance with the Agreement and the Products meet the

requirements that apply to normal (business) transactions.

2. The Purchaser is under the obligation to check and inform themselves as to how the Product should be used, and in the case of personal use, to test the Product according to the instructions for use. Brel Nederland does not accept any liability for incorrect use of the Product by the Purchaser.
3. Any eventual noticeable defects or missing parts after delivery must be notified in writing to Brel Nederland at order@brel-home.om. The Purchaser has a period of 7 days after delivery to do this. Any non-visible defects or missing parts must be reported within 7 days of their detection, but no later than 6 months after delivery. If the Product is damaged as a result of careless handling by the Purchaser, the Purchaser is personally liable for any depreciation in the value of the Product.
4. If a claim is submitted in time under the provisions of the previous paragraph, the Purchaser shall remain under obligation to pay for the purchased goods. If the Purchaser wishes to return defective goods, they must do so exclusively with the prior written permission of Brel Nederland, in the manner specified by Brel Nederland.
5. The direct costs of return shipments shall be borne by the Purchaser.
6. Brel Nederland reserves the right to launch an investigation into the authenticity and condition of the returned Products before a refund is made.
7. Refunds to the Purchaser will be processed as quickly as possible, but may take up to 30 days after receipt of the returned shipment. Refunds shall be made to the previously specified account number.
8. If the Seller exercises their right to make a claim, they will not be entitled to suspend their payment obligation or to offset outstanding invoices.
9. If delivery is not made in full, and/or if one or more Products are missing, and this is the fault of Brel Nederland, Brel Nederland will, at the Purchaser's request, send the missing Product(s) or cancel the remaining order. The confirmation of the receipt of the Products is a decisive factor in this. Any damage sustained by the Purchaser as a result of the (deviating) scope of the delivery cannot be recouped from Brel Nederland.

Article 9 - Prices

1. During the validity period of the price list, the prices of the Products on offer will not be raised, except in the event of major fluctuations in market prices, currency or transport. The Purchaser will be informed of this in good time.
2. The prices stated in the Offer are exclusive of VA T, unless explicitly stated otherwise.
3. The prices stated in the Offer are based on the cost factors applicable at the time the Agreement is concluded, such as: import and export duties, freight and unloading costs, insurance and any levies and taxes.
4. In the event that Products or raw materials are subject to price fluctuations on the financial market over which Brel Nederland has no influence, Brel Nederland reserves the right to offer these Products at variable prices. It will then be stated in the Offer that the prices are indicative prices and may be subject to change.

Article 10 - Payment and debt collection policy

1. Payment must be made subsequently in the currency of the invoice by the method indicated within the term of payment stated on the invoice.
2. The Purchaser cannot claim any rights or expectations on an estimate issued in advance, unless the parties have explicitly agreed otherwise.
3. The Purchaser must arrange for payment to be made in one instalment to the account number and details of Brel Nederland as indicated to them. The parties may only agree on different payment terms after receiving express written permission from Brel Nederland.

TERMS AND CONDITIONS

4. If a periodic payment obligation on the part of the Purchaser has been agreed to, Brel Nederland reserves the right to revise the applied prices and rates in writing, with due observance of a period of 3 months.

5. In the event of the winding-up, bankruptcy, seizure or suspension of payment by the Purchaser, the amounts receivable by Brel Nederland from the Purchaser are due immediately.

6. Brel Nederland has the right to first allocate payments made by the Purchaser to the deduction of costs, then to the deduction of interest owed, and finally to the deduction of the principal sum and the accrued interest. Brel Nederland may, without thereby falling into default, refuse an offer of payment if the Purchaser proposes a different sequence of allocation. Brel Nederland may refuse full payment of the principal sum, if the outstanding and accrued interest, together with the expenses, have also not been paid.

7. If the Purchaser fails to meet their payment obligations and has not made payment within the stipulated period of 30 days, the Purchaser will be in default.

8. From the date on which the Purchaser defaults, Brel Nederland shall, without further notice, claim the statutory (commercial) interest from the first day of default until full payment and compensation for any out-of-court legal expenses in accordance with Article 6:96 of the Dutch Civil Code, to be calculated according to the sliding scale set out in the Decree on compensation for out-of-court debt collection costs dated 1 July 2012.

9. If Brel Nederland has incurred more or higher costs that are necessary within reason, such costs will be eligible for compensation. The Purchaser is also liable for any legal and execution expenses incurred.

Article 11 - Retention of title

1. All goods delivered by Brel Nederland shall remain the property of Brel Nederland until the Purchaser has fulfilled all of their obligations under all Agreements entered into with Brel Nederland.

2. The Purchaser is not entitled to pledge the goods that fall under the retention of title or to claim any other rights if ownership has not yet been transferred in full.

3. If third parties seize goods that have been delivered and are subject to retention of title, or wish to exercise or claim rights over these goods, the Purchaser is under the obligation to inform Brel Nederland of this as soon as can reasonably be expected.

4. In the event that Brel Nederland seeks to exercise its retention of title as set out in this article, the Purchaser hereby grants unconditional and irrevocable permission and authority to Brel Nederland or third parties appointed by Brel Nederland to access all sites and locations where Brel Nederland's property is located and to recover such items.

5. Brel Nederland is entitled to retain the Product(s) purchased by the Purchaser if the Purchaser has not yet (fully) complied with their payment obligations, irrespective of any obligation on the part of Brel Nederland to deliver or hand over the Products. After the Purchaser has fulfilled their obligations, Brel Nederland shall make every effort to deliver the purchased Products to the Purchaser as soon as possible, but within 20 working days at the latest.

6. Any expenses and other (consequential) damages as a result of holding onto the purchased Products shall be at the expense and risk of the Purchaser and shall be reimbursed by the Purchaser to Brel Nederland upon the first request.

Article 12 - Warranty

1. Brel Nederland guarantees that the Products comply with the Agreement, the specifications listed in the Offer, as well as their suitability and/or soundness

and the applicable statutory rules/regulations at the time of the conclusion of the Agreement. This also applies if the goods to be delivered are intended for use abroad and the Purchaser has expressly notified the Seller of this use in writing at the time of entering into the Agreement.

2. The warranties on the Products supplied by Brel Nederland comprise: A 5-year guarantee is issued for motors with or without an integrated battery. Related Products that, in the opinion of Brel Nederland, are susceptible to wear and tear, such as transmitters, receivers, controllers, rechargeable batteries and batteries, are covered by a 1-year warranty.

3. The warranty given by Brel Nederland can only be claimed if the Purchaser has fully met all of their payment obligations.

4. If the Purchaser is justified in making a claim under an agreed warranty, Brel Nederland shall be obliged to repair or replace the Products free of charge.

5. The warranty will become null and void as soon as the warranty period has expired, or the Purchaser themselves makes alterations to the Products or has them made.

6. For Brel motors utilizing an (integrated) rechargeable battery charged by a solar panel, the Brel Solar app has been developed. This application indicates whether there is sufficient light at the location where the panel is installed to charge the battery. If the Brel Solar app indicates that the amount of light is insufficient—specifically, less than one hour of adequate light per day—no warranty can be provided.

7. Special Warranty Conditions for BREL Motors for PROJECTS

Brel does not provide a warranty on the operation of standard BREL radio motors and receivers used in (commercial) PROJECTS with central control, and in PROJECTS where more than 10 motors are controlled by a single transmitter/channel.

Which products in PROJECTS are therefore not covered by warranty?

BREL radio motors, such as BR, BRE, BZE, BEQ, BPE, BLE, and BLEQ, along with all other traditional 433 MHz BREL radio receivers and transmitters. This limitation does not apply to motors with a dry contact switching (DD) or Smart Building motors.

Article 13 - Suspension and dissolution

1. Brel Nederland is entitled to suspend fulfilment of its obligations or to dissolve the Agreement if the Purchaser fails to fulfil their (payment) obligations under the Agreement or fails to do so in full.

2. Furthermore, Brel Nederland is within its rights to dissolve, without any legal intervention, the Agreement between Brel Nederland and the Purchaser, insofar as this Agreement has not yet been fulfilled, if the Purchaser does not fulfil, or does not fulfil on time or in a satisfactory manner, the obligations that fall on them pursuant to any Agreement entered into with Brel Nederland.

3. In addition to the above, Brel Nederland is within its rights to dissolve the Agreement (or have it dissolved) without prior notice of default if circumstances arise of such a nature that fulfilment of the Agreement becomes impossible or can no longer be required on the grounds of fairness and reasonableness, or if any other circumstances arise of such a nature that the nonamended continuation of the Agreement may not be expected in all reasonableness.

4. If the Agreement is dissolved, the amounts receivable by Brel Nederland from the Purchaser shall become immediately due and payable. If Brel Nederland suspends fulfilment of its obligations, it shall retain its rights under the law and the Agreement.

5. Brel Nederland reserves the right to claim compensation for damages at all times.

TERMS AND CONDITIONS

Article 14 - Limitation of liability

1. If the fulfilment of the agreement by Brel Nederland gives rise to liability on the part of Brel Nederland vis-à-vis the Purchaser or third parties, such liability shall be limited to the costs borne by Brel Nederland related to the Agreement, unless the damage is due to wilful misconduct or gross negligence. In all cases, the liability of Brel Nederland shall be limited to the maximum amount paid out by the insurance company per incident per year.
2. Brel Nederland shall not be held liable for any consequential damage, indirect damage, loss of profits and/or incurred losses, missed savings and damage as a result of the use of the supplied Products are hereby excluded.
3. Brel Nederland is not liable for and/or under any obligation to repair damage that is caused by the use of the Product. Brel Nederland provides strict maintenance and instructions for usage that must be followed up by the Purchaser. Any damages to Products resulting from carrying them around and using them are expressly excluded from any liability (defined as: damage due to use, dropping, light and water damage, theft, disappearance etc).
4. Brel Nederland will not be held liable for any damage which is or may be the result of any act or omission as a consequence of (incomplete and/or incorrect) information on the website(s) or on linked websites.
5. Brel Nederland is not responsible for any errors and/or discrepancies in the functionality of the website and is not liable for any disruptions or unavailability of the website for whatever reason.
6. Brel Nederland can neither vouch for the correct and complete transmission of the content of emails sent by/on behalf of Brel Nederland, nor for their timely receipt.
7. All claims from the Purchaser due to any failure on the part of Brel Nederland shall become null and void if not reported to Brel Nederland in writing, stating reasons, within one year after the Purchaser became aware or could reasonably have become aware of the facts on which it bases its claims. All claims on the part of the Purchaser shall in all cases be null and void one year following the termination of the Agreement.

Article 15 - Force majeure

1. Brel Nederland shall not be held liable if it is unable to fulfil its obligations under the Agreement due to circumstances beyond its control (Force Majeure), nor can it be compelled to fulfil any obligation if it is prevented from doing so as a result of a circumstance that is not its fault and for which it cannot be held accountable under the law, a legal action or common practice.
2. Force majeure is understood to mean in all cases, but is not limited to, under the provisions of the law and jurisprudence, (i) circumstances beyond the control of suppliers to Brel Nederland, (ii) failure to properly fulfil obligations by suppliers that have been prescribed or recommended to Brel Nederland by the Purchaser, (iii) defectiveness of goods, equipment, software or materials from third parties, (iv) government measures, (v) electricity failures, (vi) disruption of the internet, data network and telecommunication facilities (e.g. as a result of cybercrime and hacking), (vii) natural disasters, (viii) war and terrorist attacks, (ix) general transport problems, (x) industrial action at the company of Brel Nederland and (xi) other situations which, in the judgement of Brel Nederland, are beyond its control and which temporarily or permanently prevent the fulfilment of its obligations.
3. Brel Nederland has the right to claim force majeure if the circumstance preventing (further) fulfilment of its obligations occurs after Brel Nederland should have fulfilled its obligation.
4. Parties may suspend their obligations under the Agreement during the time that the force majeure lasts. If this period lasts longer than two months, either party is entitled to dissolve the Agreement without any obligation to pay the other party compensation for damages.
5. Insofar as Brel Nederland has already partially fulfilled its obligations under the Agreement at the time when circumstances beyond its control arise, or will be able to fulfil them, and that part which has been or will be fulfilled has an independent value, Brel Nederland is entitled to separately invoice the part already fulfilled, or which will be fulfilled. The Purchaser is obliged to pay this invoice as if it were a separate Agreement.

Article 16 - Transfer of risk

The risk of loss of or damage to the Products that are covered by the Agreement shall pass to the Purchaser from the moment the goods leave the warehouse of Brel Nederland.

Article 17 - Intellectual Property Rights

1. All intellectual property rights and copyrights of Brel Nederland are held exclusively by Brel Nederland and are not transferable to the Purchaser.
2. The Purchaser is prohibited from disclosing and/or reproducing, altering or making available to third parties any items covered by the intellectual property rights and copyrights of Brel Nederland without the express prior written consent of Brel Nederland. If the Purchaser wishes to make any

changes to goods delivered by Brel Nederland, Brel Nederland must give its express consent to the proposed changes.

3. The Purchaser is not permitted to use the Products covered by the intellectual property rights of Brel Nederland in any way other than as agreed upon in the Agreement.
4. Any infringement by the Purchaser of the IP rights of Brel Nederland shall be penalised by a one-off fine to the sum of €10,000 and a fine of €500 for each day that the infringement continues. This penalty clause does not affect the right of Brel Nederland to claim damages.

Article 18 - Privacy, data processing and security

1. Brel Nederland will treat the (personal) data of the Purchaser and visitors to the website(s) with the utmost care. Consequently, if requested, Brel Nederland will inform the party concerned about what this entails.
2. If, on the grounds of the Agreement, Brel Nederland is required to provide security for any information, said security must comply with the agreed specifications and must be of a security level that is not unreasonable in view of the state of the technology, the sensitivity of the data and the costs involved.

Article 19 - Complaints

1. If the Purchaser is not satisfied with the Products supplied by Brel Nederland and/or has complaints about the (execution of the) Agreement, the Purchaser is under the obligation to report these complaints as soon as possible, but no later than within 14 working days of the relevant incident leading to the complaint. Complaints can be submitted to order@brel-home.com under the subject "Complaint."
2. The complaint must be adequately substantiated and/or accompanied by an explanation on the part of the Purchaser in order for Brel Nederland to be able to handle the complaint.
3. Brel Nederland will respond to the complaint as soon as possible, but no later than 14 calendar days after receiving it.
4. The parties shall attempt to reach a solution together.

Article 22 - Applicable law

1. All agreements between Brel Nederland and the Purchaser are governed by Dutch law. Applicability of the Vienna Sales Convention (CISG) is expressly excluded.
2. The Dutch text of these general terms and conditions shall prevail over any interpretation of their content and scope. Brel Nederland reserves the right to unilaterally amend these general terms and conditions.
3. All disputes arising from or as a result of the Agreement between Brel Nederland and the Purchaser will be settled by the competent court in Gelderland, location Zutphen, unless provisions of mandatory law result in the jurisdiction of another court.

Doetinchem, November 28th 2024



BREL HOME

Voltastraat 86A
7006 RW Doetinchem
Telephone: +31(0)314 680 448
E-mail: info@brel-home.com
www.brel-home.com